

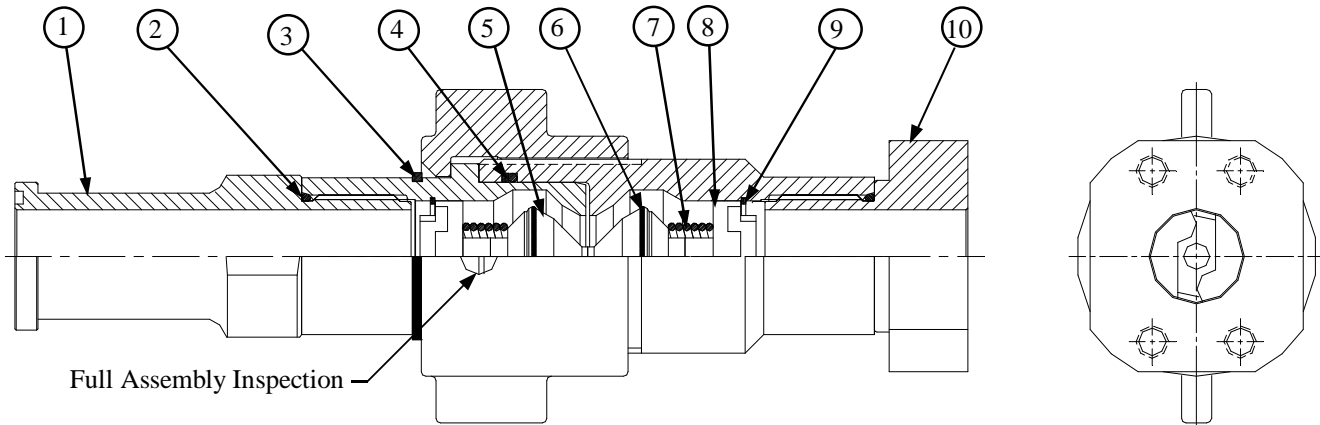

PRODUCT DATA - 6TV SERIES COUPLINGS

6TV series thread to connect steel couplings provides for high flow and low energy loss in fluid power systems common to mining, oil, construction and other natural resource sectors. Rated operating pressure for these couplings is 6,000 PSI. World class SAE J518 code 61 and code 62 four bolt flange end ports provide leak free solutions at pressures from 2,000 thru 6,000 psi. **NOTE - Not For Gas Fluid Form.**



- | | |
|---|--|
| <ol style="list-style-type: none"> 1. FLANGE HEAD ADAPTER 2. ELASTOMERIC SEAL 3. NUT RETAINING RING 4. NIPPLE SEAL (O-RING/BACK UP RING) 5. POPPET VALVE | <ol style="list-style-type: none"> 6. VALVE SEAL (SWAGED IN AGAINST WASHOUT) 7. VALVE SPRING 8. FOUR-POINT CONTACT POPPET GUIDE 9. 2-TURN LOCK RING 10. FLANGE PORT ADAPTER |
|---|--|

pub142 12-12-02

Features

- Couplers and nipple are supplied as individual items. They also mate the 5TV series rated at 5,000 psi.
- Coupler and nipple end ports are four bolt flange connections to SAE J518, code 61 or code 62, either flange head or flange ports.
- Elastomeric seals greatly reduce end port leakage potential.
- High grade steel construction provides a four to one design factor. It extends fluid port, coupler nut, and nipple thread life, allows for assembly under an amount of pressure and secures valves against wash-out under fluid surge or shock conditions.
- The hammer lug wing nut aids in assembly of coupling against an amount of pressure. Full assembly is visually verified at the coupler nut inspection ports.
- Flat crest stub-acme threads prevent galling and resist rig-up and storage damage. Coupler and Nipple dust plugs are recommended.
- Protective treatment is zinc plate to standards for S.A.E. steel hose fittings.

Physical Characteristics

Coupling Sizes	Maximum Operating Pressure (psi)	Minimum Burst Pressure (psi)	Vacuum (in. / Hg)	Rated Flow (gpm @ 20 fps)
-16	6,000	24,000	28	50
-20	6,000	24,000	28	78
-24	6,000	24,000	28	110
-32	6,000	24,000	28	196
-40	6,000	24000	28	306

SAE J518 Ports - Rated Working Pressures

SAE CODE 62 PORTS			SAE CODE 61 PORTS		
Size Inches	Dash Size	Pressure PSI	Size Inches	Dash Size	Pressure PSI
3/4	12	6,000	3/4	12	5,000
1	16	6,000	1	16	5,000
1-1/4	20	6,000	1-1/4	20	4,000
1-1/2	24	6,000	1-1/2	24	3,000
2	32	6,000	2	32	3,000
			2-1/2	40	2,500



®



6TV SERIES CODE 61 FLANGE HEAD COUPLERS & NIPPLES

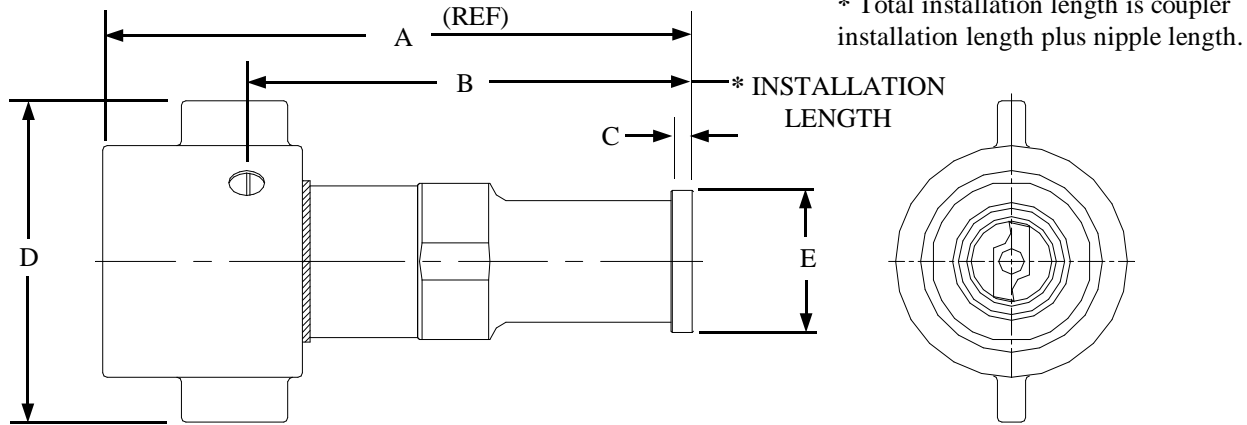

Coupler Dash Size	Coupler Part Number	Flange Dash Size	A	B	C	D	E	Wt. in Lbs.	Working Pressure Max. PSI	Dust Plug Part Number
12	6TVC5-FH12	12	6.04	4.79	.265	3.00	1.50		5,000	5TV-DP-12
16	6TVC5-FH16	16	6.85	5.26	.315	3.75	1.75	4.25	5,000	5TV-DP-16
20	6TVC4-FH20	20	8.30	6.28	.315	4.51	2.00	6.82	4,000	5TV-DP-20
24	6TVC3-FH24	24	8.72	6.42	.315	4.75	2.38	9.90	3,000	5TV-DP-24
32	6TVC3-FH32	32	10.00	6.93	.375	6.75	2.81	19.47	3,000	5TV-DP-32
40	6TVC2/5-FH40	40	11.10	7.60	.375	8.01	3.31	35.93	2,500	5TV-DP-40
48	6TVC2-FH48	48							2,000	5TV-DP-48

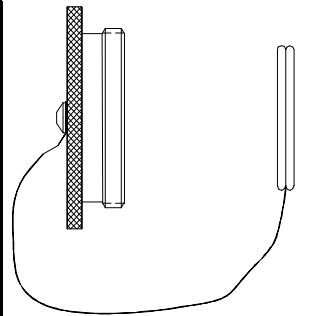

5TV COUPLING PORT DUST PLUG
Dust plugs not included unless specified.

*In an assembly where 6TV type coupling halves include SAE J518 (June 93) Code 61 or 62 four bolt split flange ports, the coupling working pressure should not exceed the lower of its port's rated values as noted here.

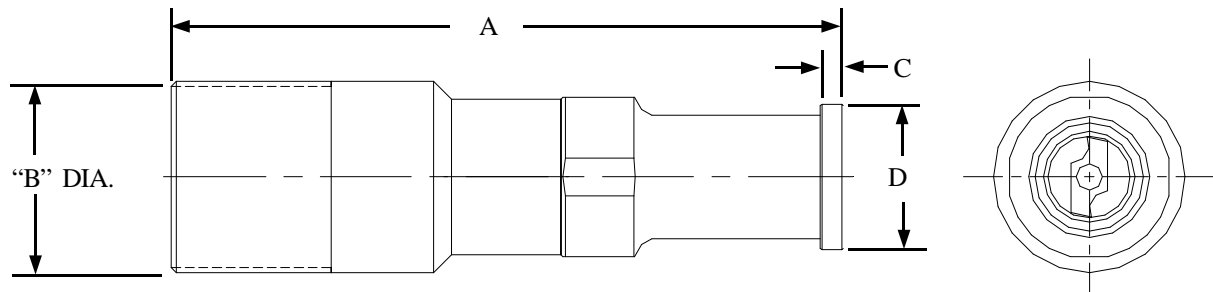

Nipple Dash Size	Nipple Part Number	Flange Dash Size	A	B	C	D	Wt. in Lbs.	Working Pressure Max. PSI	Dust Cap Part Number
12	6TVN5-FH12	12	6.46	1.75	.265	1.50		5,000	5TV-DC-12
16	6TVN5-FH16	16	7.58	2.25	.315	1.75	3.96	5,000	5TV-DC-16
20	6TVN4-FH20	20	9.23	2.63	.315	2.00	6.09	4,000	5TV-DC-20
24	6TVN3-FH24	24	9.67	3.25	.315	2.38	9.50	3,000	5TV-DC-24
32	6TVN3-FH32	32	10.98	4.00	.375	2.81	15.81	3,000	5TV-DC-32
40	6TVN2/5-FH40	40	12.93	4.25	.375	3.31	26.10	2,500	5TV-DC-40
48	6TVN2-FH48	48						2,000	5TV-DC-48

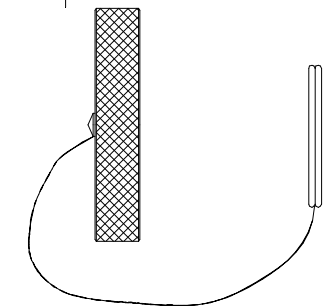

5TV COUPLING PORT DUST CAP
Dust caps not included unless specified.



6TV SERIES CODE 61 FLANGE PORT COUPLERS & NIPPLES

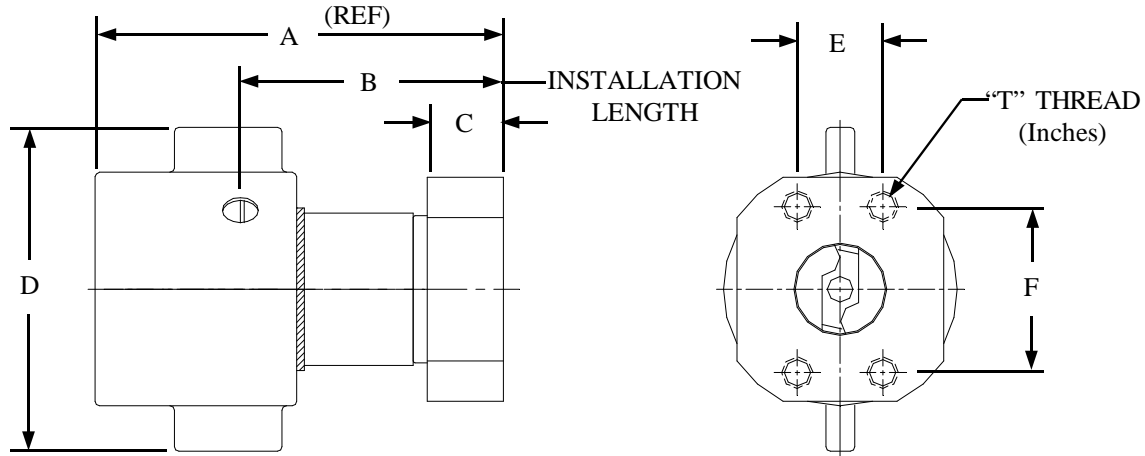

Coupler Dash Size	Coupler Part Number	Flange Dash Size	A	B	C	D	E	F	T Thread Size-UNC	Wt. in Lbs.	Working Pressure Max. PSI	Dust Plug Part Number
12	6TVC5-FP12	12	4.00	2.75	.88	3.00	.88	1.88	3/8-16		5,000	5TV-DP-12
16	6TVC5-FP16	16	4.61	3.02	.88	3.75	1.03	2.06	3/8-16	4.29	5,000	5TV-DP-16
20	6TVC4-FP20	20	5.68	3.66	1.06	4.51	1.19	2.31	7/16-14	7.22	4,000	5TV-DP-20
24	6TVC3-FP24	24	6.38	4.08	1.06	4.75	1.41	2.75	1/2-13	10.51	3,000	5TV-DP-24
32	6TVC3-FP32	32	7.41	4.34	1.06	6.75	1.69	3.06	1/2-13	19.73	3,000	5TV-DP-32
40	6TVC2/5-FP40	40	8.56	5.07	1.69	8.01	2.00	3.50	1/2-13	38.47	2,500	5TV-DP-40
48	6TVC2-FP48	48									2,000	5TV-DP-48

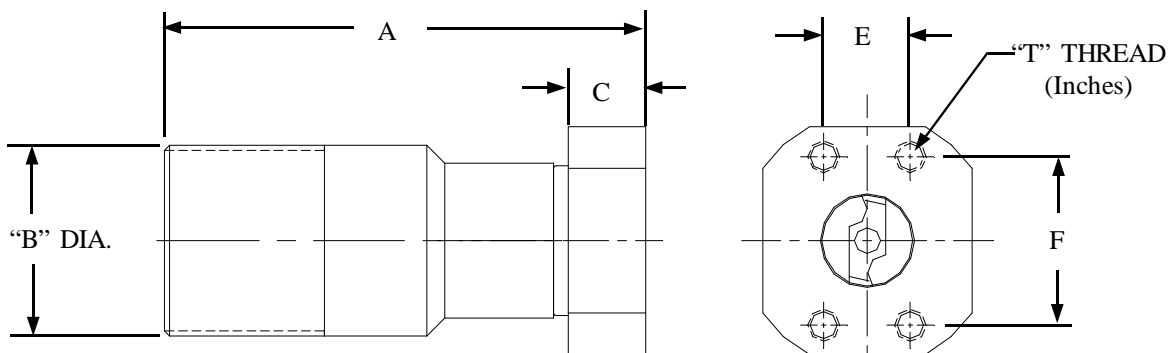

Nipple Dash Size	Nipple Part Number	Flange Dash Size	A	B	C	E	F	T Thread Size-UNC	Wt. in Lbs.	Working Pressure Max. PSI	Dust Cap Part Number
12	6TVN5-FP12	12	4.43	1.75	.88	.88	1.88	3/8-16		5,000	5TV-DC-12
16	6TVN5-FP16	16	5.33	2.25	.88	1.03	2.06	3/8-16	4.00	5,000	5TV-DC-16
20	6TVN4-FP20	20	6.61	2.63	1.06	1.19	2.31	7/16-14	6.49	4,000	5TV-DC-20
24	6TVN3-FP24	24	7.33	3.25	1.06	1.41	2.75	1/2-13	10.11	3,000	5TV-DC-24
32	6TVN3-FP32	32	8.39	4.00	1.06	1.69	3.06	1/2-13	16.07	3,000	5TV-DC-32
40	6TVN2/5-FP40	40	10.39	5.25	1.69	2.00	3.50	1/2-13	28.64	2,500	5TV-DC-40
48	6TVN2-FP48	48								2,000	5TV-DC-48



6TV SERIES CODE 62 FLANGE HEAD COUPLERS & NIPPLES

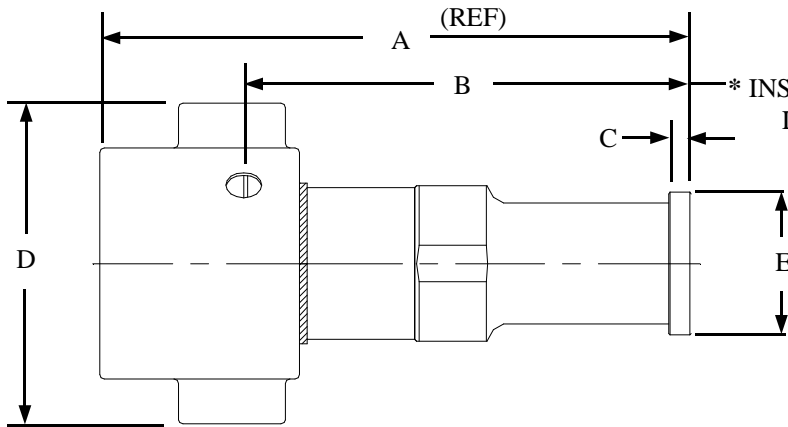

* Total installation length is coupler installation length plus nipple length.

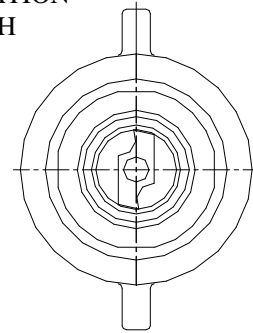

Coupler Dash Size	Coupler Part Number	Flange Dash Size	A	B	C	D	E	Wt. in Lbs.	Working Pressure Max. PSI	Dust Plug Part Number
12	6TVC6-FH12	12	6.48	5.23	.345	3.00	1.25		6,000	5TV-DP-12
16	6TVC6-FH16	16	7.70	6.11	.375	3.75	1.88	4.63	6,000	5TV-DP-16
20	6TVC6-FH20	20	8.64	6.63	.405	4.51	2.13	7.10	6,000	5TV-DP-20
24	6TVC6-FH24	24	9.16	6.86	.495	4.75	2.50	10.38	6,000	5TV-DP-24
32	6TVC6-FH32	32	10.82	7.75	.495	6.75	3.13	20.97	6,000	5TV-DP-32
40	640C6-FH32	32	11.62	8.13	.495	8.01	3.13	39.4	6,000	5TV-DP-40

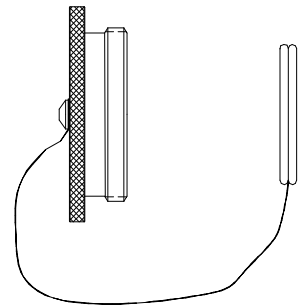

5TV COUPLING PORT DUST PLUG

Dust plugs not included unless specified.

*In an assembly where 6TV type coupling halves include SAE J518 (June 93) Code 61 or 62 four bolt split flange ports, the coupling working pressure should not exceed the lower of its port's rated values as noted here.

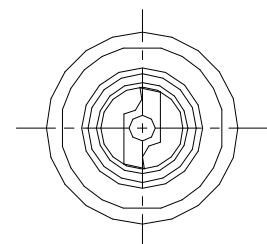
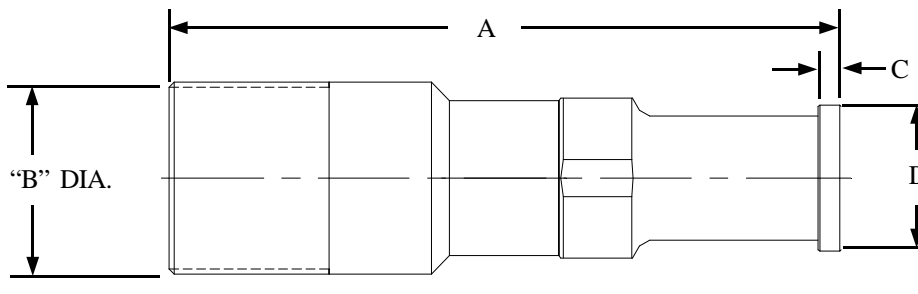

Nipple Dash Size	Nipple Part Number	Flange Dash Size	A	B	C	D	Wt. in Lbs.	Working Pressure Max. PSI	Dust Cap Part Number
12	6TVN6-FH12	12	6.90	1.75	.345	1.25		6,000	5TV-DC-12
16	6TVN6-FH16	16	8.42	2.25	.375	1.88	4.34	6,000	5TV-DC-16
20	6TVN6-FH20	20	9.57	2.63	.405	2.13	6.37	6,000	5TV-DC-20
24	6TVN6-FH24	24	10.11	3.25	.495	2.50	9.98	6,000	5TV-DC-24
32	6TVN6-FH32	32	11.80	4.00	.495	3.13	17.31	6,000	5TV-DC-32
40	640N6-FH32	32	13.45	5.25	.495	3.13	29.4	6,000	5TV-DC-40

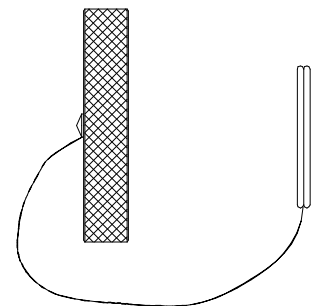

5TV COUPLING PORT DUST CAP

Dust caps not included unless specified.



6TV SERIES CODE 62 FLANGE PORT COUPLERS & NIPPLES

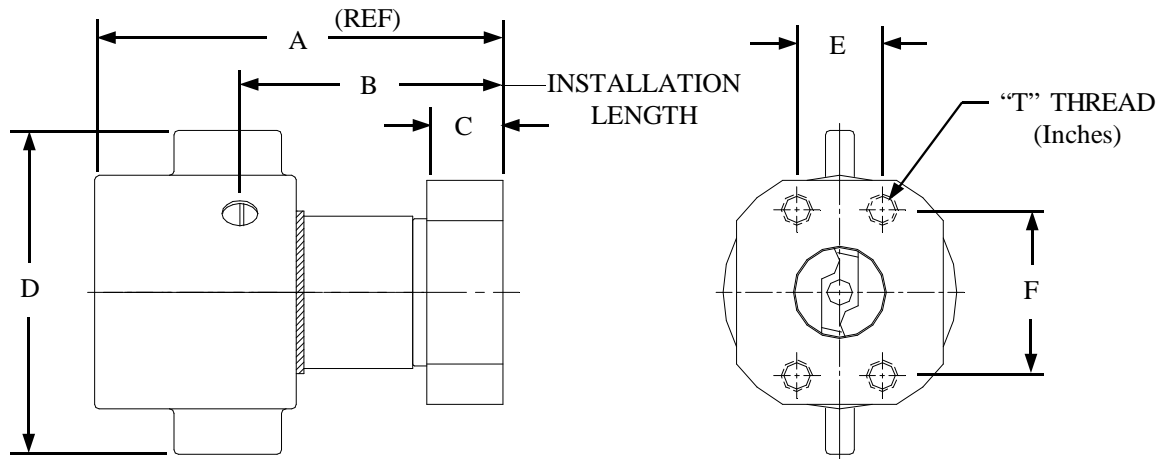

Coupler Dash Size	Coupler Part Number	Flange Dash Size	A	B	C	D	E	F	T Thread Size-UNC	Wt in Lbs.	Working Pressure Max. PSI	Dust Plug Part Number
12	6TVC6-FP12	12	4.13	2.88	0.94	3.00	0.94	2.00	3/8-16		6,000	5TV-DP-12
16	6TVC6-FP16	16	4.85	3.26	1.06	3.75	1.09	2.25	7/16-14	5.25	6,000	5TV-DP-16
20	6TVC6-FP20	20	5.88	3.86	1.12	4.51	1.25	2.63	1/2-13	8.26	6,000	5TV-DP-20
24	6TVC6-FP24	24	6.80	4.50	1.38	4.75	1.44	3.13	5/8-11	13.11	6,000	5TV-DP-24
32	6TVC6-FP32	32	8.07	5.00	1.50	6.75	1.75	3.81	3/4-10	24.62	6,000	5TV-DP-32
40	640C6-FP32	32	8.87	5.38	2.00	8.01	1.75	3.81	3/4-10	45.0	6,000	5TV-DP-40

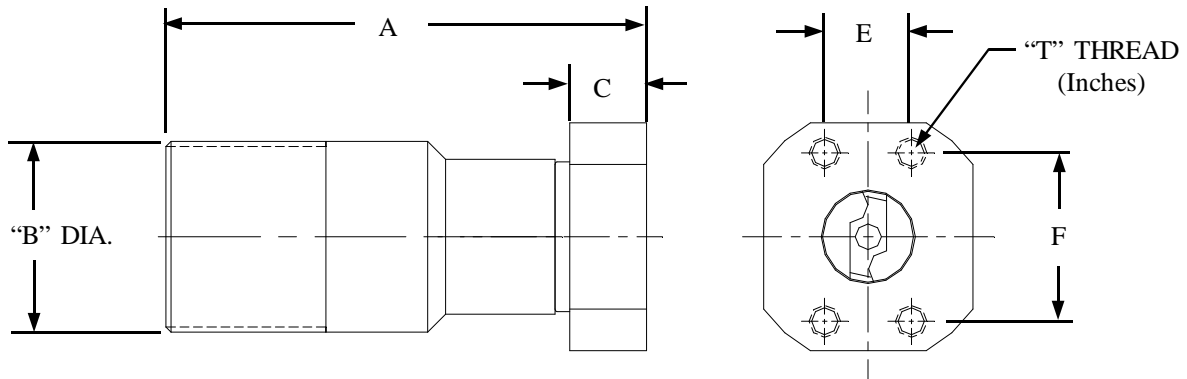

Nipple Dash Size	Nipple Part Number	Flange Dash Size	A	B	C	E	F	T Thread Size-UNC	Wt. in Lbs.	Working Pressure Max. PSI	Dust Cap Part Number
12	6TVN6-FP12	12	4.56	1.75	0.94	0.94	2.00	3/8-16		6,000	5TV-DC-12
16	6TVN5-FP16	16	5.57	2.25	1.06	1.09	2.25	7/16-14	4.96	6,000	5TV-DC-16
20	6TVN6-FP20	20	6.81	2.63	1.12	1.25	2.63	1/2-13	7.53	6,000	5TV-DC-20
24	6TVN6-FP24	24	7.75	3.25	1.38	1.44	3.13	5/8-11	12.71	6,000	5TV-DC-24
32	6TVN6-FP32	32	9.05	4.00	1.50	1.75	3.81	3/4-10	20.96	6,000	5TV-DC-32
40	640N6-FP32	32	10.70	5.25	2.00	1.75	3.81	3/4-10	35.0	6,000	5TV-DC-40



Tel: 817-923-1965
Fax: 817-927-8002

Plant & Offices
2935 St. Louis Ave
P.O. Box 6479
Ft. Worth, TX 76115-0479

OFFER OF SALE

This offer for sale by Hydraulics Inc. to the Original Equipment Manufacturer (OEM) is for items described in Hydraulics Inc. Coupling Catalog HC-111. This offer and its acceptance by the OEM ("Buyer") shall be governed by all the following Terms and Conditions. Buyers order for any item described by the catalogs, when communicated to Hydraulics Inc. ("Seller") verbally or in writing, shall constitute acceptance of this offer.

PUB142

1. Terms and Conditions of Sale: All descriptions, quotations, proposals, offers, acknowledgments, acceptances and sales of sellers products are subject to and shall be governed exclusively by the terms and conditions stated herein. Buyers acceptance of any offer to sell is limited to these terms and conditions. Any terms and conditions in addition to, or inconsistent with those stated herein, proposed by the Buyer in any acceptance of an offer by Seller, are hereby objected to. No other such additional, different or inconsistent terms and conditions shall become a part of the contract between Buyer and seller unless expressly accepted in writing by Seller. Sellers acceptance of any offer to purchase by Buyer is expressly conditional upon Buyer's assent to all terms and conditions stated herein, including any terms in addition to, or inconsistent with those contained in the Buyers offer. Acceptance of Sellers products shall in all events constitute such assent.

2. Payment: Payment for goods purchased by Buyer shall be due in 30 days from date of shipment with 1/2 % discount off goods purchased if paid in 10 days from the date of shipment. Buyer claims for omissions or shortages in a shipment shall be waived unless Seller receives notice thereof within 30 days after Buyer's receipt of the shipment.

3. Delivery: Delivery shall be made F.O.B. sellers plant, Ft. Worth TX. Regardless of the method of delivery, however, risk of loss shall pass to the Buyer upon Seller's delivery to the carrier. Any delivery dates shown are approximate only and seller shall have no liability for any delays in delivery. All offers and payments are in U.S.A. dollars.

4. Warranty: Seller warrants that the items sold hereunder shall be free from defects in material and workmanship for a period of 365 days from the date of shipment to Buyer. THIS WARRANTY COMPRISES THE SOLE AND ENTIRE WARRANTY PERTAINING TO ITEMS PROVIDED HEREUNDER. SELLER MAKES NO OTHER WARRANTY, GUARANTEE, OR REPRESENTATION OF ANY KIND WHATSOEVER. ALL OTHER WARRANTIES, INCLUDING BUT NOT LIMITED TO, MERCHANTABILITY AND FITNESS FOR PURPOSE WHETHER EXPRESS, IMPLIED, OR ARISING BY OPERATION OF LAW, TRADE USAGE, OR COURSE OF DEALING ARE HEREBY DISCLAIMED.

5. Limitation Of Remedy: SELLER'S LIABILITY ARISING FROM OR IN ANY WAY CONNECTED WITH THE ITEMS SOLD OR THIS CONTRACT SHALL BE LIMITED EXCLUSIVELY TO REPAIR OR REPLACEMENT OF THE ITEMS SOLD OR REFUND OF THE PURCHASE PRICE PAID BY BUYER, AT SELLER'S SOLE OPTION. IN NO EVENT SHALL SELLER BE LIABLE FOR ANY INCIDENTAL, CONSEQUENTIAL OR SPECIAL DAMAGES OF ANY KIND OR NATURE WHATSOEVER, INCLUDING BUT NOT LIMITED TO LOST PROFITS ARISING FROM OR IN ANY WAY CONNECTED WITH THIS AGREEMENT OR ITEMS SOLD HEREUNDER, WHETHER ALLEGED TO ARISE FROM BREACH OF CONTRACT, EXPRESS OR IMPLIED WARRANTY, OR IN TORT, INCLUDING WITHOUT LIMITATION, NEGLIGENCE, FAILURE TO WARN OR STRICT LIABILITY.

6. Changes, Reschedules and Cancellations: Buyer may request to modify the designs or specifications for the items sold hereunder as well as the quantities and delivery dates thereof, or may request to cancel all or part of this

order, however, no such requested modification or cancellation shall become part of the contract between the Buyer and Seller unless accepted by the Seller in a written amendment to this Agreement. Acceptance of any such requested modification or cancellation shall be at the Seller's discretion, and shall be upon such terms and conditions as Seller may require.

7. Returns: Buyer may request to return items sold hereunder, however no such requests shall become part of the contract between Buyer and Seller unless accepted by the Seller in a written amendment to this Agreement.

8. Taxes: Unless otherwise indicated on the face hereof, all prices and charges are exclusive of excise, sales, use, property, occupational or like taxes which may be imposed by any taxing authority upon the manufacture, sale or delivery of the items sold hereunder. If any such tax must be paid by the Seller or if Seller is liable for the collection of such tax, the amount thereof shall be in addition to the amounts of the items sold. Buyer agrees to pay all such taxes or to reimburse Seller therefore upon receipt of its invoice. If Buyer claims exemption from any sales, use or other tax imposed by any taxing authority, Buyer shall save Seller harmless from against such tax, together with any interest or penalties thereon which may be assessed if the items are held to be taxable.

9. Force Majeure: Seller does not assume the risk of and shall not be liable for delay or failure to perform any of Seller's obligations by reason of circumstances beyond control of Seller (hereinafter events of Force Majeure). Events of Force Majeure shall include without limitation, accidents, acts of God, strikes or labor disputes, acts, laws, rules or regulations of any government agency, fires, floods, delays or failures in delivery of carriers or suppliers, shortages of materials and any other cause beyonds Seller's control.

10. Entire Agreement / Governing Law: The terms and conditions set forth herein, together with any amendments, modifications and any terms or conditions expressly accepted by Seller in writing, shall constitute the entire Agreement concerning the items sold, and there are no oral or other representations or agreements which pertain thereto. This agreement shall be governed in all respects by the law of the State of Texas. No actions arising out of sale of the items sold hereunder or this Agreement may be brought by either party more than two (2) years after the cause of the action accrues.