

Keeping the world moving and working.

At Alkon, we are committed to providing quality products for customer needs. Our fittings and valves can be found in applications as varied as eighteen-wheelers to amusement park rides. Why? Because our precision engineering, innovative manufacturing, and dedicated service convince our customers that at Alkon, we get it right.



Can-do. World class. Capable. Entrepreneurial. Global.
Pneumatic connection supplier to the world.



About Us

The personal touch of a small company drives our world-class manufacturing operation. For our employees, meeting customer needs is the primary concern. We take the time to understand each job and client. We take the opportunity to provide each customer with products of superior quality and value. We take pride that strong relationships and outstanding products result in continued customer satisfaction.

Service. Satisfaction. Success. This is Alkon's philosophy.

History

Alkon Corporation began in Hawthorne, New Jersey as a start-up company, carrying a single line. Since its creation in 1950, the company, and its product line, has grown steadily. In 1999, the corporate headquarters moved to our current 70,000 square foot facility in Fremont, Ohio. Our line has expanded to include a wide variety of fittings, valves, and flow controls. An additional manufacturing facility in Mexico, Alkon-Mexico, partners with us in production of forgings and primary machining.

We are a privately held company. Many of our employees – from executives to shop employees – are shareholders. We are active in Alkon's growth and invested in Alkon's success.



Capabilities

Alkon's history – over fifty years of expertise in the fitting and valves industry – positions us to provide a vast array of services to our clients. From our role as a major U.S. manufacturer of brass push-to-connect (PTC) fittings, to our unique technologies for producing lapped spool valves, Alkon supplies what our clients need, when they need it.

Alkon's focus is to provide a quality product with an innovative design. We have the expertise and the technology to produce custom fittings and valves, from the design stage, through engineering to manufacturing. Unlike many of our competitors, we apply our own thread seal. Sealant material quality, and that of all incoming materials, must meet our high standards.

Alkon's state-of-the-art manufacturing facility can handle a variety of runs and processes to ensure that orders, no matter what size are met, and that processes are done with quality and care. We monitor inventory carefully, so that components are always available and changes in orders are accurate. Our custom storage units guarantee that orders are assembled efficiently and shipped on time.

Quality Pledge

Alkon Corporation is committed to robust quality and service through continuous improvement, innovative design, dependable delivery, and an emphasis on customer relations.

Warranty

Alkon Corporation warrants its products to be free of defects in material and workmanship when properly installed and maintained. No other warranty is implied or expressed. Alkon Corporation's liability for and remedy to is limited to replacement or repair at Alkon's sole discretion if the parts are returned under a valid RGA to us within 180 days of purchase. No allowance whatsoever will be made for repairs made by the purchaser nor will Alkon be liable for consequential or other damages or any expense incurred through the use of its products. The warranty is valid solely on products of current design.

Alkon Corporation is constantly upgrading its products. In keeping with this policy, Alkon Corporation reserves the right to change dimensions, designs and/or performance. These changes may be made at any time.

Corporate Headquarters / USA Head Office

Alkon Corporation

728 Graham Drive
Fremont, OH 43420
P: 419-333-7000
F: 419-355-9211

Mexico Head Office

Alkon Products, S.A. de C.V.

Destajistas No. 20
Parque Industrial Xhala
Cuautitlan Izcalli EDO. DE MEX.
C.P. 54730, P: 872-46-97
P: 872-58-09, F: 872-31-62

www.alkoncorp.com
sales@alkoncorp.com

CONTACT US



2010 Fittings Product Catalog

Our line of fittings is one of the most extensive available on the market today. Alkon is prime supplier of PTC fittings to the Department of Defense for the Abrams tank and the Stryker vehicle programs. Our products are used on aircraft carriers and low riders, on trucks and world-class drag racers.

TABLE OF CONTENTS

How to Use the Alkon Push-In Fittings.....	4
Series AQ Brass Push-In Fittings.....	5
Series AQ-DOT Air Brake Brass Push-In Fittings	14
Series MAQ Brass Push-In Metric Fittings.....	21
Series MAQ-DOT Metric Air Brake Brass Push-In Fittings	26
Options.....	27
Series AP Brass Tube Fittings for Plastic Tubing	28
Series 60 Compression Fittings.....	35
Customized Fittings	37
Series 100 Pipe Fittings.....	38
Series 29 Barb Adapters	43
Fittings for Misting Applications.....	44
Series NQ-NTA Air Brake Brass Compression Fittings	45
Series AP310 Angle & In-Line Needle Valves	49
Series J Angle & In-Line Flow Control, Needle & Check Valves.....	50
Industrial Tubing & Accessories	52
J844 Air Brake Tubing.....	53
Tubing Accessories.....	54
Emergency Repair Kits	55
Series MQ Manifolds with Pre-Installed Push-In Fitting Cartridges.....	56

SERIES AQ

Brass Push-In Fittings



How to Use the Alkon Push-In Fittings



To Connect Tube

Cut plastic as squarely as possible. Insert tube into fitting until friction is felt as tube slides past the O-ring. Using a slight twisting motion while inserting the tube is often helpful. After this initial friction is felt, continue to push in the tube until it bottoms firmly against the internal tube stop.



To Disconnect Tube

With thumb and forefinger, hold down the top of the insert against the fitting body, and with the other hand, pull out the tubing. No tools are needed.

When tubing (1) is inserted into the fitting, it first passes through the gripping teeth (2). Just beyond the gripping teeth is the O-ring (3) which provides the leak proof seal against the O.D. of the tube. The gripping teeth grab the tube, which expands the insert. Pulling back on the tube only tightens the grip as the insert moves onto the camming surface (4).

Pressure through the tube also serves to tighten the grip. The tube bottoms against a positive tube stop (5) in a cavity providing tube support to prevent leakage.

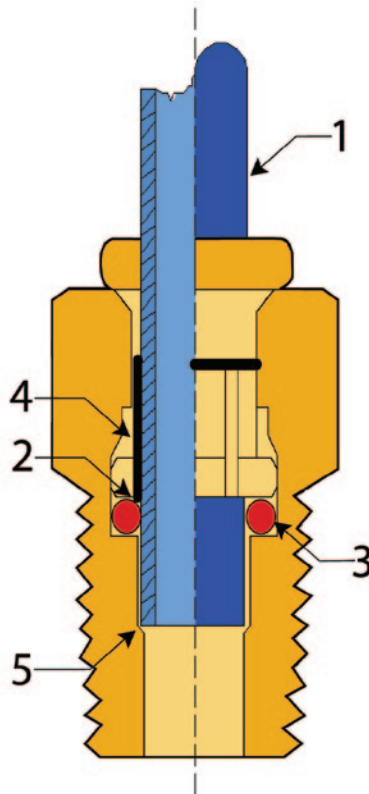

Alkon AQ Push-To-Connect are designed for Compressed Air Application. For all other applications consult factory.

SPECIFICATIONS

Alkon AQ-DOT Series meet D.O.T. FMVSS 571.106 Air Brake Performance Requirements; SAE J1131, J2494-1 & J2494-3 Air Brake Performance Requirements.

Materials of Construction

Body (straights), tube supports and grippers: Brass CA 360; Forged Elbows and Tees: Brass CA377; "O" Ring: NBR-269, alternate compounds on request.

Temperature Range

-40°F to 212°F (other ranges available upon request)

Threads

NPTF Standard. For other thread standards consult factory.

Tube "O.D." Sizes

AQ Series - 1/8", 5/32", 3/16", 1/4", 3/8", 1/2"
 AQ-DOT Series - 5/32", 3/16", 1/4", 3/8", 1/2", 5/8", 3/4"
 MAQ Series - 4mm, 6mm, 8mm, 10mm, 12mm

Recommended Tubing

AQ & MAQ Series - Polyethylene, Polyurethane 95A Durometer and Nylon
 AQ-DOT Series - J844 Air Brake Tubing

Working Pressure

The fitting is suitable for use up to the maximum working pressure of the recommended plastic tubing.

PRODUCT FEATURES

Positive Seal

Tube support area beyond "O" ring exceeds that of all competitive products, compensates for bias cut tubing and dramatically reduces troubleshooting time.

Swivel and Fixed Elbows and Tees

Convenient swivel threaded fittings that allow close center line installation, eliminating orientation problems. Fixed fittings offer the utmost in economy.

Thread Sealant

Pre-applied at no charge to all AQ Series male threads. Thread Sealant: Loctite® 516 standard (others available upon request).

Custom Designs

Alkon offers custom parts on short notice and welcomes these opportunities.

CAD data available at www.alkoncorp.com.

Loctite® is a trademarks of Henkel Corporation, U.S.A.

SERIES AQ

Brass Push-In Fittings

AQ34/32 BARB ADAPTER

Part Number	A	B	C
AQ34-B-1*	0.50	0.09	0.250
AQ34-B-2*	0.50	0.20	0.250
AQ32-B-1*	0.23	0.09	0.125

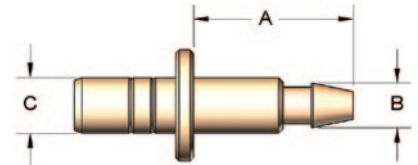

AQ52-P UNION CROSS

Part Number	Tube O.D.	A	B	C
AQ52-P-2	1/8	0.73	1.46	5/16
AQ52-P-5/32*	5/32	0.76	1.52	5/16
AQ52-P-4	1/4	1.05	2.10	3/8
AQ52-P-6	3/8	1.08	2.16	1/2
AQ52-P-8*	1/2	1.26	2.52	5/8

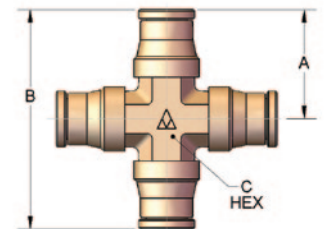

AQ54-P 45° MALE ELBOW

Part Number	Tube O.D.	Pipe	A	B	C
AQ54-P-4X2*	1/4	1/8	0.75	3/8	.99
AQ54-P-4X4*	1/4	1/4	.89	3/8	.99
AQ54-P-6X2*	3/8	1/8	0.75	1/2	.99
AQ54-P-6X4*	3/8	1/4	0.95	1/2	1.08
AQ54-P-6X6*	3/8	3/8	.97	1/2	1.08
AQ54-P-8X4*	1/2	1/4	1.00	5/8	1.20
AQ54-P-8X6*	1/2	3/8	1.05	5/8	1.20
AQ54-P-8X8	1/2	1/2	1.20	5/8	1.20

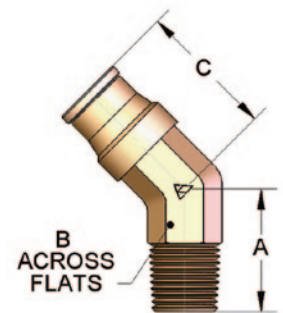

AQ56-P TUBE TO TUBE UNION REDUCER

Part Number	Tube O.D. 1	Tube O.D. 2	A	B
AQ56-P-4X5/32*	1/4	5/32	1.43	7/16
AQ56-P-6X4	3/8	1/4	1.85	5/8

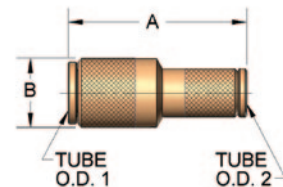

AQ59-P PLUG

Part Number	A	B	C
AQ59-P-2	1/8	1.12	0.35
AQ59-P-5/32	5/32	1.16	0.32
AQ59-P-4	1/4	1.40	0.43
AQ59-P-6	3/8	1.40	0.55
AQ59-P-8	1/2	1.50	0.70

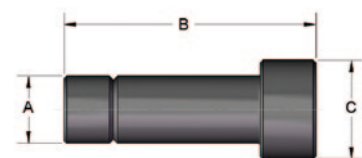

SERIES AQ

Brass Push-In Fittings

AQ62-P UNION CONNECTOR

Part Number	Tube O.D.	A	B
AQ62-P-2	1/8	1.23	3/8
AQ62-P-5/32	5/32	1.34	3/8
AQ62-P-4	1/4	1.82	7/16
AQ62-P-6	3/8	1.82	21/32
AQ62-P-8	1/2	2.02	25/32

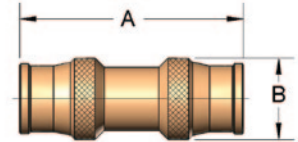

AQ64-P UNION TEE

Part Number	Tube O.D.	A	B	C
AQ64-P-2	1/8	0.73	0.91	5/16
AQ64-P-5/32	5/32	0.76	0.94	5/16
AQ64-P-3	3/16	0.83	1.04	3/8
AQ64-P-4	1/4	0.94	1.17	3/8
AQ64-P-6	3/8	1.08	1.41	1/2
AQ64-P-8	1/2	1.26	1.65	5/8

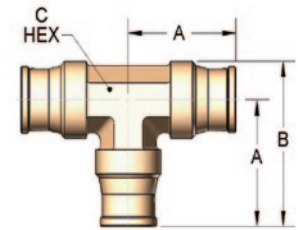

AQ65-P UNION ELBOW

Part Number	Tube O.D.	A	B	C
AQ65-P-2	1/8	0.73	0.91	5/16
AQ65-P-5/32	5/32	0.76	0.94	5/16
AQ65-P-4	1/4	0.94	1.17	3/8
AQ65-P-6	3/8	1.08	1.41	1/2
AQ65-P-8	1/2	1.26	1.65	5/8

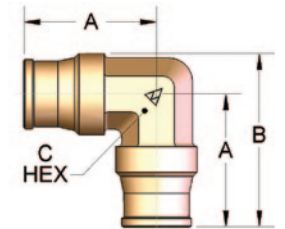

AQ66-P FEMALE CONNECTOR

Part Number	Tube O.D.	Female Pipe	A	B
AQ66-P-2X2	1/8	1/8	1.04	9/16
AQ66-P-5/32X2	5/32	1/8	1.09	9/16
AQ66-P-4X2	1/4	1/8	1.33	9/16
AQ66-P-4X4	1/4	1/4	1.55	3/4
AQ66-P-6X4	3/8	1/4	1.52	3/4
AQ66-P-6X6	3/8	3/8	1.56	7/8
AQ66-P-8X8	1/2	1/2	1.85	1-1/8

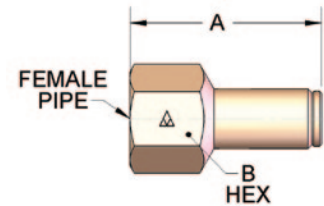

SERIES AQ

Brass Push-In Fittings

AQ688-P PRESS-IN CARTRIDGE

Part Number	Tube O.D.	A	B	C
AQ688-P-2X00	1/8	0.67	0.47	3/8
AQ688-P-5/322X00	5/32	0.67	0.47	3/8
AQ688-P-3X00 *	3/16	0.72	0.57	7/16
AQ688-P-4X00	1/4	0.95	0.69	1/2
AQ688-P-6X00	3/8	1.23	0.97	5/8

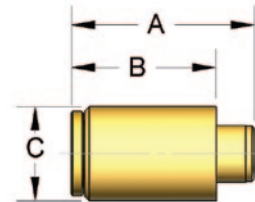

AQ68-P MALE CONNECTOR

Part Number	Tube O.D.	Pipe	A	B
AQ68-P-2X0	1/8	10-32**	0.79	3/8
AQ68-P-2X1	1/8	1/16	0.76	3/8
AQ68-P-2X2	1/8	1/8	0.77	7/16
AQ68-P-5/32X0	5/32	10-32**	0.79	3/8
AQ68-P-5/32X2	5/32	1/8	0.77	7/16
AQ68-P-5/32X4	5/32	1/4	0.95	9/16
AQ68-P-3X0	3/16	10-32**	0.89	3/8
AQ68-P-3X2	3/16	1/8	1.01	7/16
AQ68-P-4X0	1/4	10-32**	0.99	7/16
AQ68-P-4X1	1/4	1/16	1.17	7/16
AQ68-P-4X2	1/4	1/8	0.98	7/16
AQ68-P-4X4	1/4	1/4	0.90	9/16
AQ68-P-4X6	1/4	3/8	0.87	11/16
AQ68-P-6X2	3/8	1/8	1.17	11/16
AQ68-P-6X4	3/8	1/4	1.15	11/16
AQ68-P-6X6	3/8	3/8	1.12	11/16
AQ68-P-6X8	3/8	1/2	1.03	7/8
AQ68-P-8X4	1/2	1/4	1.46	13/16
AQ68-P-8X6	1/2	3/8	1.28	13/16
AQ68-P-8X8	1/2	1/2	1.23	7/8

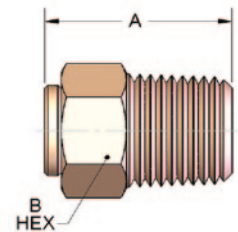

AQ699-PS SWIVEL BANJO ELBOW

Part Number	Tube O.D.	Pipe	A	B	C	D
AQ699-PS-5/32X0	5/32	10-32**	0.71	0.67	5/16	0.46
AQ699-PS-5/32X2 *	5/32	1/8	0.76	1.14	1/2	0.69
AQ699-PS-4X2 *	1/4	1/8	0.95	1.14	1/2	0.69
AQ699-PS-4X4 *	1/4	1/4	0.95	1.49	5/8	0.95
AQ699-PS-4X6 *	1/4	3/8	1.08	1.67	3/4	1.09
AQ699-PS-6X4 *	3/8	1/4	0.95	1.46	5/8	1.12
AQ699-PS-6X6 *	3/8	3/8	1.08	1.67	3/4	1.31

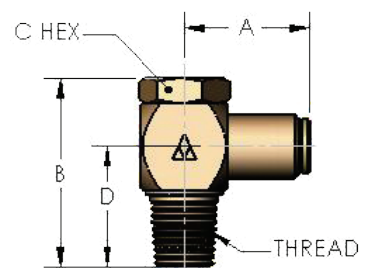

* Made to Order -- consult factory for price and availability. ** Furnished with nylon gasket.

SERIES AQ

Brass Push-In Fittings

AQ69-P MALE ELBOW

Part Number	Tube O.D.	Pipe	A	B	C	D
AQ69-P-2X2	1/8	1/8	0.77	0.69	5/16	0.87
AQ69-P-5/32X2	5/32	1/8	0.76	0.68	5/16	0.89
AQ69-P-3X2	3/16	1/8	0.83	0.71	3/8	0.92
AQ69-P-4X2	1/4	1/8	0.97	0.79	3/8	0.99
AQ69-P-4X4	1/4	1/4	1.03	0.84	3/8	1.02
AQ69-P-4X6	1/4	3/8	1.08	0.98	1/2	1.27
AQ69-P-6X2	3/8	1/8	1.03	0.80	1/2	1.12
AQ69-P-6X4	3/8	1/4	1.06	0.98	1/2	1.29
AQ69-P-6X6	3/8	3/8	1.05	0.98	1/2	1.31
AQ69-P-8X4	1/2	1/4	1.23	1.05	5/8	1.44
AQ69-P-8X6	1/2	3/8	1.23	1.05	5/8	1.44
AQ69-P-8X8	1/2	1/2	1.24	1.26	5/8	1.64

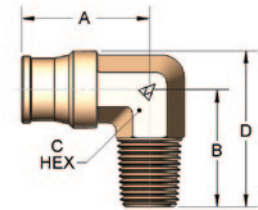

AQ69-PS SWIVEL MALE ELBOW

Part Number	Tube O.D.	Pipe	A	B	C	D	E
AQ69-PS-2X2	1/8	1/8	0.76	0.90	7/16	1.11	3/8
AQ69-PS-5/32X0	5/32	10-32**	0.77	0.79	5/16	0.91	5/16
AQ69-PS-5/32X2	5/32	1/8	0.77	0.88	7/16	1.10	3/8
AQ69-PS-5/32X4	5/32	1/4	0.77	1.08	9/16	1.29	3/8
AQ69-PS-3X2	3/16	1/8	0.84	0.89	7/16	1.11	3/8
AQ69-PS-4X0	1/4	10-32**	0.96	0.76	5/16	1.00	3/8
AQ69-PS-4X2	1/4	1/8	0.94	0.90	7/16	1.14	3/8
AQ69-PS-4X4	1/4	1/4	1.02	1.09	9/16	1.33	3/8
AQ69-PS-4X6	1/4	3/8	1.02	1.13	11/16	1.37	3/8
AQ69-PS-6X2	3/8	1/8	1.05	1.06	7/16	1.39	1/2
AQ69-PS-6X4	3/8	1/4	1.08	1.14	9/16	1.46	1/2
AQ69-PS-6X6	3/8	3/8	1.10	1.23	11/16	1.55	1/2
AQ69-PS-6X8	3/8	1/2	1.10	1.53	7/8	1.85	1/2
AQ69-PS-8X4	1/2	1/4	1.26	1.26	9/16	1.65	5/8
AQ69-PS-8X6	1/2	3/8	1.26	1.31	11/16	1.70	5/8
AQ69-PS-8X8	1/2	1/2	1.25	1.61	7/8	2.00	5/8

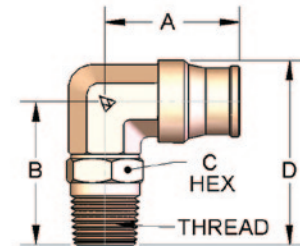

** Furnished with nylon gasket.

SERIES AQ

Brass Push-In Fittings

AQ70-P FEMALE ELBOW

Part Number	Tube O.D.	Female Pipe	A	B	C	D
AQ70-P-2X2	1/8	1/8	0.78	0.82	3/8	1.04
AQ70-P-5/32X2	5/32	1/8	0.76	0.82	3/8	1.04
AQ70-P-4X2	1/4	1/8	1.02	0.83	3/8	1.06
AQ70-P-4X4	1/4	1/4	1.13	1.03	1/2	1.31
AQ70-P-6X4	3/8	1/4	1.08	0.98	1/2	1.31

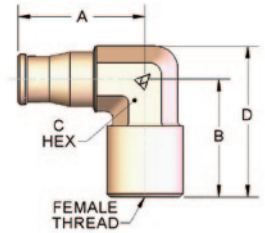

AQ70-PS SWIVEL FEMALE ELBOW

Part Number	Tube O.D.	Female Pipe	A	B	C	D	E
AQ70-PS-5/32X2	5/32	1/8	0.73	1.04	3/8	1.22	9/16
AQ70-PS-4X2	1/4	1/8	1.02	1.06	3/8	1.30	9/16
AQ70-PS-4X4	1/4	1/4	0.97	1.25	3/8	1.49	3/4
AQ70-PS-6X4	3/8	1/4	1.08	1.48	1/2	1.80	3/4
AQ70-PS-6X6 *	3/8	3/8	1.10	1.66	1/2	1.99	7/8
AQ70-PS-8X6 *	1/2	3/8	1.25	1.70	5/8	2.09	7/8

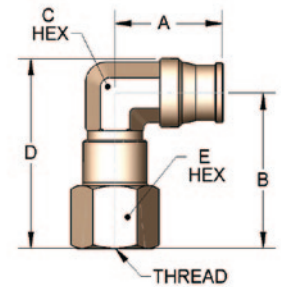

AQ71-P MALE RUN TEE

Part Number	Tube O.D.	Pipe	A	B	C	D	E
AQ71-P-2X2 *	1/8	1/8	0.73	0.66	5/16	0.66	0.91
AQ71-P-5/32X2	5/32	1/8	0.75	0.67	5/16	0.75	0.95
AQ71-P-3X2 *	3/16	1/8	0.83	0.73	3/8	0.83	1.05
AQ71-P-4X2	1/4	1/8	1.02	0.75	3/8	1.02	1.24
AQ71-P-4X4	1/4	1/4	1.02	0.92	7/16	1.02	1.27
AQ71-P-6X2 *	3/8	1/8	1.02	0.92	1/2	1.02	1.29
AQ71-P-6X4	3/8	1/4	1.08	0.98	1/2	1.08	1.40
AQ71-P-6X6	3/8	3/8	1.08	0.98	1/2	1.08	1.31
AQ71-P-8X6 *	1/2	3/8	1.26	1.05	5/8	1.26	1.55

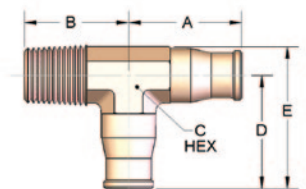

AQ71-PS SWIVEL MALE RUN TEE

Part Number	Tube O.D.	Pipe	A	B	C	D	E
AQ71-PS-2X2	1/8	1/8	0.73	0.73	5/16	0.86	7/16
AQ71-PS-5/32X0 *	5/32	10-32**	0.76	0.76	5/16	0.73	5/16
AQ71-PS-5/32X2	5/32	1/8	0.76	0.76	5/16	0.82	7/16
AQ71-PS-4X2	1/4	1/8	1.02	1.02	3/8	1.01	7/16
AQ71-PS-4X4	1/4	1/4	1.02	1.02	7/16	1.08	9/16
AQ71-PS-6X2 *	3/8	1/8	1.08	1.08	1/2	1.08	7/16
AQ71-PS-6X4	3/8	1/4	1.04	1.04	1/2	1.15	9/16
AQ71-PS-6X6	3/8	3/8	1.06	1.06	1/2	1.17	11/16
AQ71-PS-8X6 *	1/2	3/8	1.24	1.24	5/8	1.28	11/16
AQ71-PS-8X8	1/2	1/2	1.24	1.24	5/8	1.58	7/8

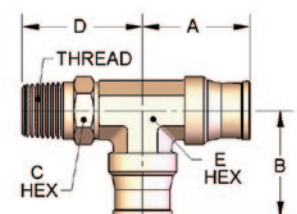

* Made to Order -- consult factory for price and availability. ** Furnished with nylon gasket.

SERIES AQ

Brass Push-In Fittings

AQ72-P MALE BRANCH TEE

Part Number	Tube O.D.	Pipe	A	B	C	D
AQ72-P-2X2 *	1/8	1/8	0.73	0.66	5/16	0.84
AQ72-P-5/32X2	5/32	1/8	0.76	0.66	5/16	0.84
AQ72-P-3X2 *	3/16	1/8	0.88	0.78	3/8	1.00
AQ72-P-4X2	1/4	1/8	1.02	0.75	3/8	0.98
AQ72-P-6X2	3/8	1/8	1.08	0.80	1/2	1.13
AQ72-P-6X4	3/8	1/4	1.08	0.99	1/2	1.31
AQ72-P-6X6	3/8	3/8	1.09	0.98	1/2	1.31
AQ72-P-8X4 *	1/2	1/4	1.26	1.07	5/8	1.45
AQ72-P-8X6 *	1/2	3/8	1.26	1.07	5/8	1.45

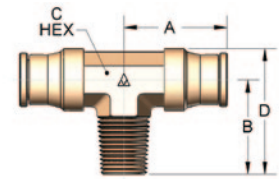

AQ72-PS SWIVEL MALE BRANCH TEE

Part Number	Tube O.D.	Pipe	A	B	C	D	E
AQ72-PS-2X2	1/8	1/8	0.73	0.65	5/16	0.81	7/16
AQ72-PS-5/32X0 *	5/32	10-32**	0.76	0.72	5/16	0.90	5/16
AQ72-PS-5/32X2	5/32	1/8	0.78	0.82	3/8	1.00	7/16
AQ72-PS-4X2	1/4	1/8	1.02	1.04	3/8	1.28	7/16
AQ72-PS-4X4	1/4	1/4	1.01	1.23	3/8	1.47	9/16
AQ72-PS-6X2	3/8	1/8	1.08	1.07	1/2	1.40	7/16
AQ72-PS-6X4	3/8	1/4	1.06	1.17	1/2	1.50	9/16
AQ72-PS-6X6	3/8	3/8	1.08	1.21	1/2	1.54	11/16
AQ72-PS-8X6	1/2	3/8	1.26	1.31	5/8	1.70	11/16
AQ72-PS-8X8	1/2	1/2	1.26	1.61	5/8	2.00	7/8

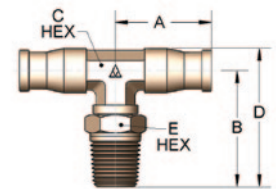

AQ73-P REDUCING MALE BRANCH TEE

Part Number	Tube O.D. 1, O.D. 2	Pipe	A	B	C	D	E
AQ73-P-6X4X2 *	3/8, 1/4	1/8	1.08	0.93	1/2	0.98	1.31
AQ73-P-6X4X4 *	3/8, 1/4	1/4	1.08	1.02	1/2	0.98	1.31

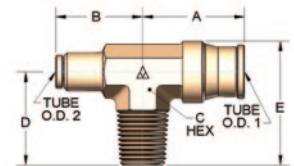

AQ74-P MALE/FEMALE BRANCH TEE

Part Number	Tube O.D.	M, F Thread	A	B	C	D	E
AQ74-P-4X6X4 *	3/8	1/4, 1/4	1.08	0.99	1/2	0.98	1.31

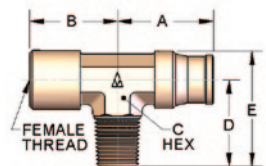

AQ75-P TUBE/BARB MALE BRANCH TEE

Part Number	Tube O.D.	Thread, Barb	A	B	C	D	E
AQ75-P-6X4X4B *	3/8	1/4, 1/4	1.08	0.97	1/2	1.29	1.07

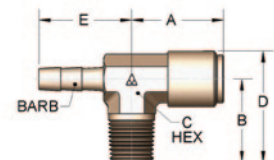

* Made to Order -- consult factory for price and availability. ** Furnished with nylon gasket.

SERIES AQ

Brass Push-In Fittings

AQ76-P MALE/FEMALE RUN TEE

Part Number	Tube O.D.	Female, Male	A	B	C	D	E
AQ76-P-2X4X2	1/4	1/8, 1/8	0.82	0.82	7/16	1.02	1.29
AQ76-P-4X4X2 *	1/4	1/8, 1/4	0.73	0.87	7/16	1.03	1.30

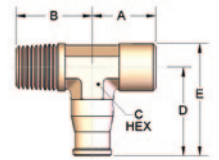

AQ77-P FEMALE BRANCH TEE

Part Number	Tube O.D.	Pipe	A	B	C	D
AQ77-P-4X2	1/4	1/8	1.02	0.82	1/2	1.11
AQ77-P-4X4 *	1/4	1/4	1.08	0.97	1/2	1.26
AQ77-P-6X4	3/8	1/4	1.09	0.98	1/2	1.31

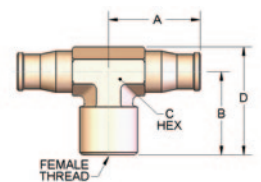

AQ77-PS SWIVEL FEMALE BRANCH TEE

Part Number	Tube O.D.	Pipe	A	B	C	D	E
AQ77-PS-4X2*	1/4	1/8	1.02	1.13	3/8	1.36	9/16

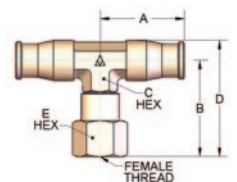

AQ78-P REDUCING MALE RUN TEE

Part Number	Tube O.D. 1	Tube O.D. 2	Pipe	A	B	C	D	E
AQ78-P-6X4X4 *	3/8	1/4	1/4	1.08	0.98	1/2	1.08	1.40

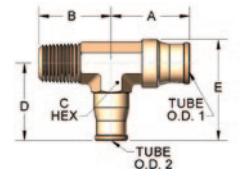

AQ79-P UNION REDUCING TEE

Part Number	Tube O.D. 1	Tube O.D. 2	A	B	C	D
AQ79-P-2X3 *	1/8	3/16	0.76	0.78	5/16	0.96
AQ79-P-4X2 *	1/4	1/8	0.98	0.90	3/8	1.16
AQ79-P-6X2 *	3/8	1/8	1.08	0.92	1/2	1.22
AQ79-P-6X5/32 *	3/8	5/32	1.06	0.98	1/2	1.11
AQ79-P-6X4 *	3/8	1/4	1.08	1.04	1/2	1.37

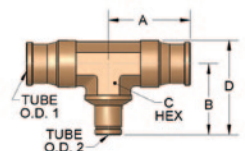

AQ82-P BULKHEAD UNION

Part Number	Tube O.D.	A	B	C	D	E
AQ82-P-2 *	1/8	1.28	1.12	5/8	5/8	7/16-20
AQ82-P-5/32	5/32	1.28	1.12	5/8	5/8	7/16-20
AQ82-P-3 *	3/16	1.43	1.27	11/16	11/16	1/2-20
AQ82-P-4	1/4	1.90	1.69	11/16	11/16	1/2-20
AQ82-P-6	3/8	1.85	1.69	15/16	15/16	3/14-16
AQ82-P-8	1/2	2.05	1.85	1-1/8	1-1/8	15/16-16

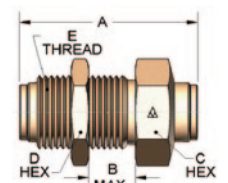

SERIES AQ

Brass Push-In Fittings

AQ86-P FEMALE BULKHEAD UNION

Part Number	Tube O.D.	Pipe	A	B	C	D
AQ86-P-4X2	1/4	1/8	1.29	11/16	1/2-20	0.63
AQ86-P-4X4	1/4	1/4	1.46	3/4	1/2-20	0.63
AQ86-P-6X4	3/8	1/4	1.81	3/4	5/8-18	0.99

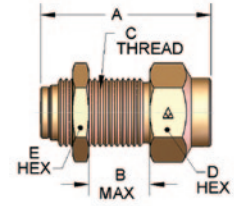

AQ87-P "Y" CONNECTOR FEMALE

Part Number	Tube O.D.	Pipe	A	B	C
AQ87-P-4X4 *	1/4	1/4	1.98	1.98	3/4

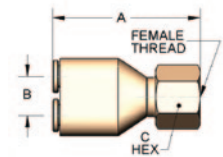

AQ88-P "Y" CONNECTOR MALE NPT TO DUAL AQ TUBE CONNECTOR

Part Number	Tube O.D. 1	Tube O.D. 2	Pipe	A	B	C
AQ88-P-5/32X2 *	5/32	5/32	1/8	1.46	0.44	7/16
AQ88-P-5/32X4 *	5/32	5/32	1/4	1.64	0.44	9/16
AQ88-P-4X2 *	1/4	1/4	1/8	1.83	0.50	7/16
AQ88-P-4X4	1/4	1/4	1/4	2.01	0.50	9/16

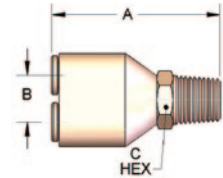

AQ89-P "Y" CONNECTOR TRIPLE TUBE TO TUBE TO TUBE CONNECTOR

Part Number	Tube O.D. 1	Tube O.D. 2	A	B
AQ89-P-5/32	5/32	5/32	1.39	0.44
AQ89-P-5/32X2 *	5/32	1/8	1.37	0.44
AQ89-P-5/32X4 *	5/32	1/4	1.63	0.44
AQ89-P-4	1/4	1/4	1.36	0.50
AQ89-P-4X2	1/4	1/8	1.75	0.50

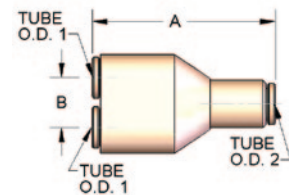

AQ90-P "Y" CONNECTOR DUAL TUBE WITH PLUG-IN MALE STUD

Plug-in stud connects to AQ fitting of same tube O.D. and has through passage for air

Part Number	Tube O.D. 1	Tube O.D. 2	Stud O.D.	A	B
AQ90-P-5/32 *	5/32	5/32	5/32	1.48	0.44
AQ90-P-5/32X4 *	5/32	5/32	1/4	1.70	0.44
AQ90-P-4 *	1/4	1/4	1/4	2.07	0.50
AQ90-P-4X5/32 *	1/4	1/4	5/32	1.85	0.50

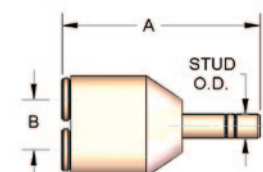

* Made to Order -- consult factory for price and availability.

SERIES AQ

Brass Push-In Fittings

AQ92-P QUICK DISCONNECT

When tube is disconnected, flow shuts off automatically

Part Number	Tube O.D.	Pipe	A	B
AQ92-P-4X2	1/4	1/8	0.81	9/16
AQ92-P-4X4	1/4	1/4	1.03	9/16
AQ92-P-6X4 *	3/8	1/4	1.16	2.05

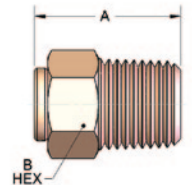

AQ97-P REDUCING UNION

For use with SERIES "AQ" Fittings only

Part Number	Tube O.D.	Stub O.D.	A
AQ97-P-2X4	1/8	1/4	1.38
AQ97-P-5/32X4	5/32	1/4	1.44
AQ97-P-5/32X6 *	5/32	3/8	1.44
AQ97-P-4X6	1/4	3/8	1.62
AQ97-P-4X8	1/4	1/2	1.69
AQ97-P-6X8 *	3/8	1/2	1.69

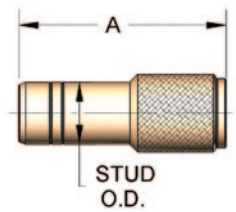

AQ99-P EXPANDER UNION

For use with SERIES "AQ" Fittings only

Part Number	Tube O.D.	Stub O.D.	A
AQ99-P-4X5/32 *	1/4	5/32	1.39
AQ99-P-6X4	3/8	1/4	1.66

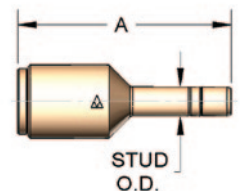

* Made to Order -- consult factory for price and availability.



SERIES AQ-DOT

Air Brake Brass Push-In Fittings

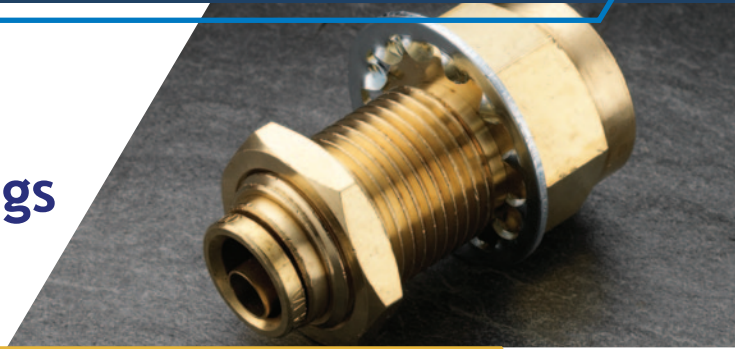

SPECIFICATIONS

Temperature Range:
Threads:
Recommended Tubing:

-40°F to 225°F
NPTF Standard
J844 Air Brake Tubing

Alkon AQ-DOT Series meet D.O.T. FMVSS 571.106 Air Brake Performance Requirements; SAE J1131, J2494-1 & J2494-3 Air Brake Performance Requirements.

AQ54-DOT 45° MALE ELBOW

Part Number	Tube O.D.	Pipe	A	B	C
AQ54-DOT-4X2	1/4	1/8	0.75	3/8	0.99
AQ54-DOT-4X4	1/4	1/4	0.89	3/8	0.99
AQ54-DOT-6X2	3/8	1/8	0.75	1/2	0.99
AQ54-DOT-6X4	3/8	1/4	0.95	1/2	1.08
AQ54-DOT-6X6	3/8	3/8	0.97	1/2	1.08
AQ54-DOT-6X8	3/8	1/2	1.13	5/8	1.15
AQ54-DOT-8X4	1/2	1/4	1.00	5/8	1.20
AQ54-DOT-8X6	1/2	3/8	1.05	5/8	1.20
AQ54-DOT-8X8	1/2	1/2	1.20	5/8	1.20
AQ54-DOT-10X6 *	5/8	3/8	1.17		1.22
AQ54-DOT-10X8	5/8	1/2	1.31	11/16	1.22
AQ54-DOT-12X8 *	3/4	1/2	1.36	15/16	1.18
AQ54-DOT-12X12 *	3/4	3/4	1.36	15/16	1.18

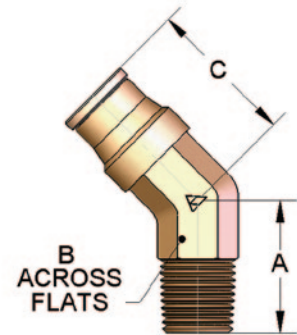

AQ54-DOT SWIVEL 45° MALE ELBOW

Part Number	Tube O.D.	Pipe	A	B	C	D
AQ54-DOTS-4X2	1/4	1/8	0.98	3/8	0.99	7/16
AQ54-DOTS-4X4	1/4	1/4	1.06	3/8	0.99	7/16
AQ54-DOTS-6X2	3/8	1/8	1.08	1/2	1.06	7/16
AQ54-DOTS-6X4	3/8	1/4	1.13	1/2	1.06	9/16
AQ54-DOTS-6X6	3/8	3/8	1.23	1/2	1.08	11/16
AQ54-DOTS-8X4 *	1/2	1/4	1.22	5/8	1.22	9/16
AQ54-DOTS-8X6	1/2	3/8	1.31	5/8	1.20	11/16
AQ54-DOTS-8X8	1/2	1/2	1.61	5/8	1.20	7/8
AQ54-DOTS-10X8	5/8	1/2	1.68	11/16	1.39	7/8
AQ54-DOTS-12X12 *	3/4	3/4	2.28	15/16	1.40	1-1/16

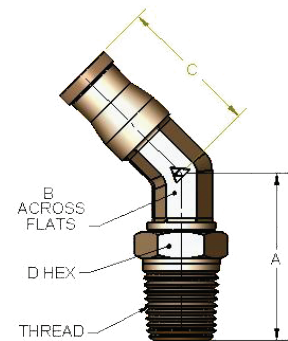

* Made to Order -- consult factory for price and availability.

SERIES AQ-DOT

Air Brake Brass Push-In Fittings

AQ59 NYLON PLUG

Part Number	A
AQ59-P-5/32	5/32
AQ59-P-4	1/4
AQ59-P-6	3/8
AQ59-P-8	1/2

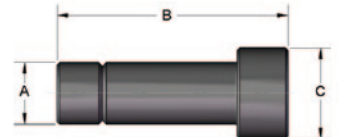

AQ62-DOT UNION CONNECTOR

Part Number	Tube O.D.	A	B
AQ62-DOT-5/32	5/32	1.38	3/8
AQ62-DOT-4	1/4	1.82	7/16
AQ62-DOT-6	3/8	1.82	21/32
AQ62-DOT-8	1/2	2.02	25/32
AQ62-DOT-10	5/8	2.04	0.91
AQ62-DOT-12	3/4	2.20	1.06

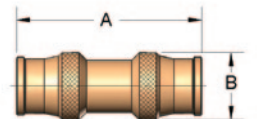

AQ64-DOT UNION TEE

Part Number	Tube O.D.	A	B	C
AQ64-DOT-4	1/4	0.94	1.17	3/8
AQ64-DOT-6	3/8	1.08	1.41	1/2
AQ64-DOT-8	1/2	1.26	1.65	5/8
AQ64-DOT-10	5/8	1.32	1.77	11/16
AQ64-DOT-12 *	3/4	1.44	1.99	15/16

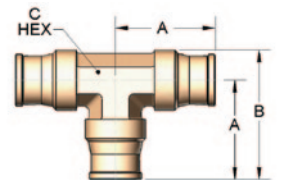

AQ65-DOT UNION ELBOW

Part Number	Tube O.D.	A	B	C
AQ65-DOT-4	1/4	0.94	1.17	3/8
AQ65-DOT-6	3/8	1.08	1.41	1/2
AQ65-DOT-8	1/2	1.26	1.65	5/8

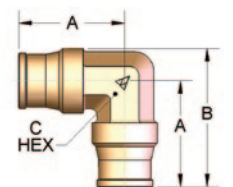

AQ66-DOT FEMALE CONNECTOR

Part Number	Tube O.D.	Female Pipe	A	B
AQ66-DOT-4X2	1/4	1/8	1.33	9/16
AQ66-DOT-4X4	1/4	1/4	1.55	3/4
AQ66-DOT-6X4	3/8	1/4	1.52	3/4
AQ66-DOT-6X6	3/8	3/8	1.56	7/8
AQ66-DOT-8X6 *	1/2	3/8	1.59	7/8
AQ66-DOT-8X8 *	1/2	1/2	1.85	1-1/8

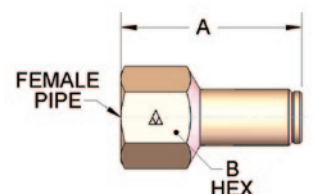

SERIES AQ-DOT

Air Brake Brass Push-In Fittings

AQ688-DOT PRESS-IN CARTRIDGE

Part Number	Tube O.D.	A	B	C
AQ688-DOT-5/32 *	5/32	0.59	0.69	0.32
AQ688-DOT-3 *	3/16	0.68	0.78	0.41
AQ688-DOT-4 *	1/4	0.76	0.86	0.41
AQ688-DOT-4X6 *	1/4	0.81	0.91	0.64
AQ688-DOT-6 *	3/8	0.82	0.92	0.64
AQ688-DOT-6X8 *	3/8	0.92	1.02	0.77
AQ688-DOT-8 *	1/2	0.92	1.02	0.77
AQ688-DOT-10 *	5/8	1.10	1.00	0.92
AQ688-DOT-12 *	3/4	1.16	1.06	1.06

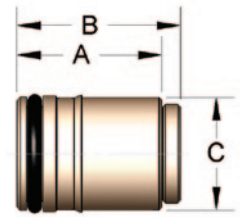

AQ68-DOT MALE CONNECTOR

Part Number	Tube O.D.	Pipe	A	B
AQ68-DOT-5/32X1	5/32	1/16	0.78	3/8
AQ68-DOT-5/32X2	5/32	1/8	0.79	7/16
AQ68-DOT-4X1	1/4	1/16	1.17	7/16
AQ68-DOT-4X2	1/4	1/8	0.98	7/16
AQ68-DOT-4X4	1/4	1/4	0.90	9/16
AQ68-DOT-4X6 *	1/4	3/8	0.87	11/16
AQ68-DOT-6X2	3/8	1/8	1.17	11/16
AQ68-DOT-6X4	3/8	1/4	1.15	11/16
AQ68-DOT-6X6	3/8	3/8	1.12	11/16
AQ68-DOT-6X8	3/8	1/2	1.03	7/8
AQ68-DOT-8X4	1/2	1/4	1.46	13/16
AQ68-DOT-8X6	1/2	3/8	1.28	13/16
AQ68-DOT-8X8	1/2	1/2	1.23	7/8
AQ68-DOT-10X6	5/8	3/8	1.44	15/16
AQ68-DOT-10X8	5/8	1/2	1.59	15/16
AQ68-DOT-12X8	3/4	1/2	1.65	1-1/16
AQ68-DOT-12X12	3/4	3/4	1.38	1-1/16

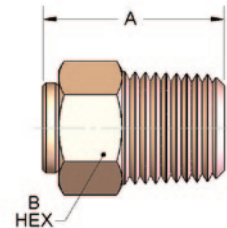

AQ698-DOTS PRESS-IN CARTRIDGE ELBOW

Part Number	Tube O.D.	A	B	C	D	E
AQ698-DOTS-5/32 *	5/32	0.79	0.46	3/8	0.64	1.04
AQ698-DOTS-4 *	1/4	0.99	0.48	3/8	0.70	1.05
AQ698-DOTS-6 *	3/8	1.08	0.63	1/2	0.92	1.35
AQ698-DOTS-8 *	1/2	1.26	0.77	5/8	1.13	1.66

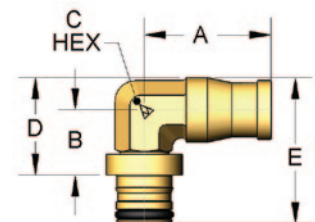

* Made to Order -- consult factory for price and availability.

SERIES AQ-DOT

Air Brake Brass Push-In Fittings

AQ69-DOT MALE ELBOW

Part Number	Tube O.D.	Pipe	A	B	C	D
AQ69-DOT-5/32X2	5/32	1/8	0.78	0.69	5/16	0.89
AQ69-DOT-4X2	1/4	1/8	1.01	0.79	3/8	0.99
AQ69-DOT-4X4	1/4	1/4	1.05	0.84	3/8	1.07
AQ69-DOT-4X6	1/4	3/8	1.10	0.98	1/2	1.27
AQ69-DOT-6X2	3/8	1/8	1.00	0.80	1/2	1.12
AQ69-DOT-6X4	3/8	1/4	1.10	0.98	1/2	1.29
AQ69-DOT-6X6	3/8	3/8	1.08	0.98	1/2	1.31
AQ69-DOT-6X8	3/8	1/2	1.14	1.20	5/8	1.56
AQ69-DOT-8X4	1/2	1/4	1.26	1.05	5/8	1.44
AQ69-DOT-8X6	1/2	3/8	1.26	1.05	5/8	1.44
AQ69-DOT-8X8	1/2	1/2	1.25	1.26	5/8	1.64
AQ69-DOT-10X6	5/8	3/8	1.25	1.26	5/8	1.59
AQ69-DOT-10X8	5/8	1/2	1.34	1.29	11/16	1.74
AQ69-DOT-12X8	3/4	1/2	1.32	1.36	15/16	1.90
AQ69-DOT-12X12	3/4	3/4	1.32	1.36	15/16	1.90

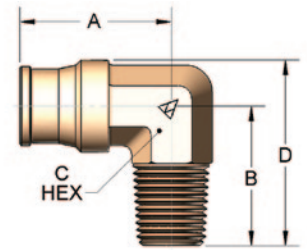

AQ69-DOTS SWIVEL MALE ELBOW

Part Number	Tube O.D.	Pipe	A	B	C	D	E
AQ69-DOTS-5/32X2	5/32	1/8	0.79	0.88	7/16	1.10	3/8
AQ69-DOTS-5/32X4 *	5/32	1/4	0.79	1.08	9/16	1.29	3/8
AQ69-DOTS-4X2	1/4	1/8	0.94	0.90	7/16	1.13	3/8
AQ69-DOTS-4X4	1/4	1/4	0.99	1.09	9/16	1.33	3/8
AQ69-DOTS-4X6	1/4	3/8	1.02	1.13	11/16	1.37	3/8
AQ69-DOTS-6X2	3/8	1/8	1.05	1.06	7/16	1.39	1/2
AQ69-DOTS-6X4	3/8	1/4	1.08	1.14	9/16	1.46	1/2
AQ69-DOTS-6X6	3/8	3/8	1.10	1.23	11/16	1.55	1/2
AQ69-DOTS-6X8	3/8	1/2	1.10	1.53	7/8	1.85	1/2
AQ69-DOTS-8X4	1/2	1/4	1.26	1.26	9/16	1.65	5/8
AQ69-DOTS-8X6	1/2	3/8	1.26	1.31	11/16	1.70	5/8
AQ69-DOTS-8X8	1/2	1/2	1.25	1.61	7/8	2.00	5/8
AQ69-DOTS-10X6	5/8	3/8	1.54	1.41	11/16	1.86	11/16
AQ69-DOTS-10X8	5/8	1/2	1.54	1.71	7/8	2.16	11/16
AQ69-DOTS-12X8	3/4	1/2	1.40	2.04	1-1/16	2.46	15/16
AQ69-DOTS-12X12	3/4	3/4	1.40	1.60	1-1/16	2.14	15/16

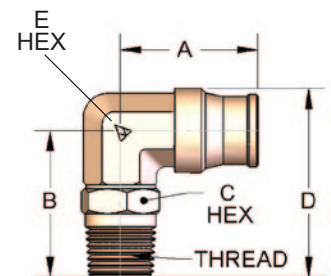

SERIES AQ-DOT

Air Brake Brass Push-In Fittings

AQ70-DOT FEMALE ELBOW

Part Number	Tube O.D.	Female Pipe	A	B	C	D
AQ70-DOT-4X2	1/4	1/8	1.02	0.83	3/8	1.06
AQ70-DOT-4X4	1/4	1/4	1.13	1.03	1/2	1.31
AQ70-DOT-4X6 *	1/4	3/8	1.27	0.99	5/8	1.35
AQ70-DOT-6X4	3/8	1/4	1.08	0.98	1/2	1.31
AQ70-DOT-6X6	3/8	3/8	1.08	1.05	5/8	1.41
AQ70-DOT-8X8 *	1/2	1/2	1.37	1.31	5/8	1.70

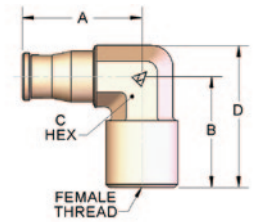

AQ70-DOTS SWIVEL FEMALE ELBOW

Part Number	Tube O.D.	Female Pipe	A	B	C	D	E
AQ70-DOTS-4X4	1/4	1/4	0.97	1.25	3/8	1.49	3/4

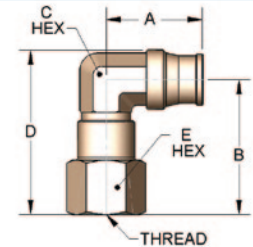

AQ71-DOT MALE RUN TEE

Part Number	Tube O.D.	Pipe	A	B	C	D	E
AQ71-DOT-4X2	1/4	1/8	1.02	0.75	3/8	1.02	1.24
AQ71-DOT-4X4	1/4	1/4	1.02	0.92	7/16	1.02	1.27
AQ71-DOT-6X4	3/8	1/4	1.08	0.98	1/2	1.08	1.40
AQ71-DOT-6X6	3/8	3/8	1.08	0.98	1/2	1.08	1.31
AQ71-DOT-8X6 *	1/2	3/8	1.26	1.05	5/8	1.26	1.55

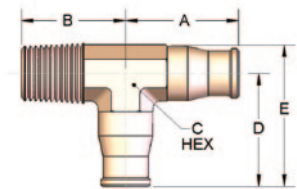

AQ71-DOTS SWIVEL MALE RUN TEE

Part Number	Tube O.D.	Pipe	A	B	C	D	E
AQ71-DOTS-4X2	1/4	1/8	1.02	1.02	3/8	1.01	7/16
AQ71-DOTS-4X4	1/4	1/4	1.02	1.02	7/16	1.08	9/16
AQ71-DOTS-6X4	3/8	1/4	1.04	1.04	1/2	1.15	9/16
AQ71-DOTS-6X6	3/8	3/8	1.06	1.06	1/2	1.17	11/16
AQ71-DOTS-8X6	1/2	3/8	1.24	1.24	5/8	1.28	11/16
AQ71-DOTS-8X8	1/2	1/2	1.24	1.24	5/8	1.58	7/8

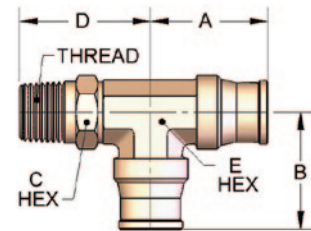

AQ72-DOT MALE BRANCH TEE

Part Number	Tube O.D.	Pipe	A	B	C	D
AQ72-DOT-4X2	1/4	1/8	1.02	0.75	3/8	0.98
AQ72-DOT-4X4	1/4	1/4	1.02	0.92	7/16	1.17
AQ72-DOT-6X4	3/8	1/4	1.08	0.99	1/2	1.31
AQ72-DOT-6X6	3/8	3/8	1.09	0.99	1/2	0.31
AQ72-DOT-8X4 *	1/2	1/4	1.26	1.07	5/8	1.45
AQ72-DOT-8X6	1/2	3/8	1.26	1.07	5/8	1.45

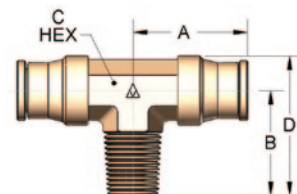

* Made to Order -- consult factory for price and availability.

SERIES AQ-DOT

Air Brake Brass Push-In Fittings

AQ72-DOTS SWIVEL MALE BRANCH TEE

Part Number	Tube O.D.	Pipe	A	B	C	D	E
AQ72-DOTS-4X2	1/4	1/8	1.02	1.04	3/8	1.28	7/16
AQ72-DOTS-4X4	1/4	1/4	1.01	1.04	3/8	1.30	9/16
AQ72-DOTS-6X2	3/8	1/8	1.08	1.07	1/2	1.40	7/16
AQ72-DOTS-6X4	3/8	1/4	1.06	1.17	1/2	1.50	9/16
AQ72-DOTS-8X4	1/2	1/4	1.26	1.28	5/8	1.67	9/16
AQ72-DOTS-8X6	1/2	3/8	1.26	1.31	5/8	1.70	11/16
AQ72-DOTS-8X8	1/2	1/2	1.26	1.61	5/8	2.00	7/8

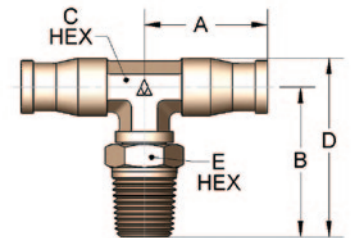

AQ77-DOT FEMALE BRANCH TEE

Part Number	Tube O.D.	Female Pipe	A	B	C	D
AQ77-DOT-4X2	1/4	1/8	1.02	0.82	1/2	1.11
AQ77-DOT-4X4	1/4	1/4	1.08	0.97	1/2	1.26
AQ77-DOT-6X4	3/8	1/4	1.09	0.98	1/2	1.31
AQ77-DOT-6X6 *	3/8	3/8	1.40	1.30	11/16	1.70

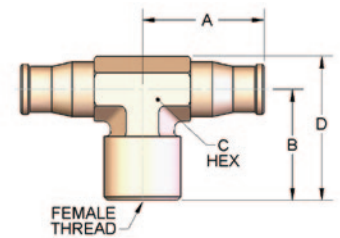

AQ77-DOTS SWIVEL FEMALE BRANCH TEE

Part Number	Tube O.D.	Female Pipe	A	B	C	D	E
AQ77-DOTS-4X2 *	1/4	1/8	1.02	1.13	3/8	1.36	9/16
AQ77-DOTS-4X4 *	1/4	1/4	1.02	1.29	3/8	1.52	3/4
AQ77-DOTS-6X4 *	3/8	1/4	1.08	1.16	1/2	1.49	3/4

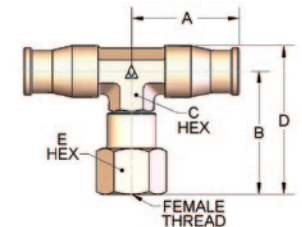

AQ78-DOT REDUCING MALE RUN TEE

Part Number	Tube O.D. 1	Tube O.D. 2	Pipe	A	B	C	D	E
AQ78-DOT-6X4X4 *	3/8	1/4	1/4	1.08	0.98	1/2	1.08	1.48

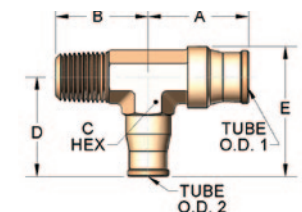

AQ79-DOT UNION REDUCING TEE

Part Number	Tube O.D. 1	Tube O.D. 2	A	B	C	D
AQ79-DOT-4X6	1/4	3/8	1.00	1.08	1/2	1.23
AQ79-DOT-6X5/32	3/8	5/32	1.08	0.85	1/2	1.08
AQ79-DOT-6X4	3/8	1/4	1.08	1.04	1/2	1.37

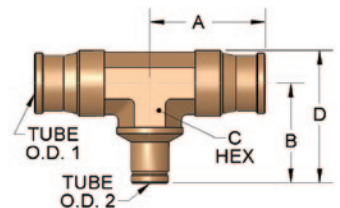

SERIES AQ-DOT

Air Brake Brass Push-In Fittings

AQ82-DOT BULKHEAD UNION

Part Number	Tube O.D. 1	A	B	C	D	E
AQ82-DOT-4	1/4	1.90	1.00	11/16	11/16	1/2-20
AQ82-DOT-6	3/8	1.85	1.00	15/16	15/16	3/4-16
AQ82-DOT-8	1/2	2.05	1.82	15/16	1-1/8	15/16-16
AQ82-DOT-10	5/8	2.05	0.94	1-1/4	1-3/8	1/14

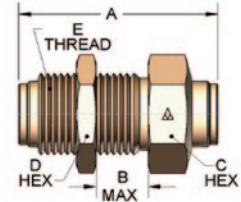

AQ83-DOT GLADHAND BULKHEAD CONNECTOR

Part Number	Tube O.D. 1	Female Pipe	A	B	C	D
AQ83-DOT-6X8 *	3/8	1/2	1.99	1-14	1-3/8	1-1/4
AQ83-DOT-8X8	1/2	1/2	1.99	1-14	1-3/8	1-1/4

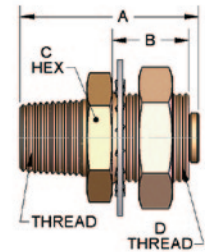

AQ86-DOT FEMALE BULKHEAD UNION

Part Number	Tube O.D.	Female Pipe	A	B	C	D	E
AQ86-DOT-4X2	1/4	1/8	1.32	0.64	1/2-20	11/16	11/16
AQ86-DOT-4X4	1/4	1/4	1.56	0.64	1/2-20	11/16	11/16
AQ86-DOT-6X4	3/8	1/4	1.87	1.00	3/4-16	15/16	15/16
AQ86-DOT-6X6	3/8	3/8	1.87	1.00	3/4-16	15/16	15/16
AQ86-DOT-8X6	1/2	3/8	2.04	1.00	15/16-16	1-1/8	1 3/8

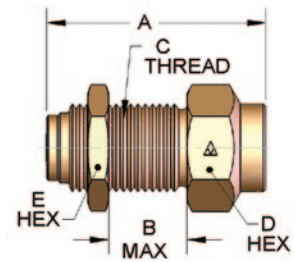

* Made to Order -- consult factory for price and availability.





SERIES MAQ

Brass Push-In Metric Fittings

SPECIFICATIONS

Temperature Range: -20°F to 250°F
 Threads: BSPT
 Recommended Tubing: Nylon

MAQ56-P TUBE TO TUBE UNION REDUCER

Part Number	Tube O.D. 1	Tube O.D. 2	A	B
MAQ56-P-4MX5/32 *	4mm	5/32	1.18	11.1
MAQ56-P-6MX4 *	6mm	1/4	1.43	14.3
MAQ56-P-8MX4 *	8mm	1/4	1.53	14.3
MAQ56-P-8MX6 *	8mm	3/8	1.58	14.3
MAQ56-P-10MX6 *	10mm	3/8	1.58	18.3
MAQ56-P-12MX8 *	12mm	1/2	1.73	20.6

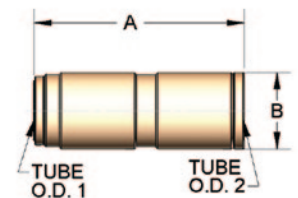

MAQ62-P UNION

Part Number	Tube O.D.	A	B
MAQ62-P-4	4mm	29.7	11.2
MAQ62-P-6	6mm	32.0	14.2
MAQ62-P-8	8mm	36.8	14.3
MAQ62-P-10	10mm	36.8	18.3
MAQ62-P-12	12mm	38.4	20.2

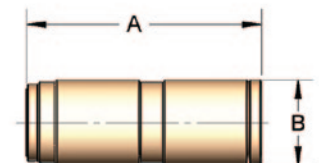

MAQ64-P UNION TEE

Part Number	Tube O.D.	A	B	C
MAQ64-P-4 *	4mm	16.7	16.7	7.9
MAQ64-P-6	6mm	20.8	20.8	9.5
MAQ64-P-8	8mm	24.1	24.1	11.1
MAQ64-P-10 *	10mm	24.7	24.7	12.7
MAQ64-P-12 *	12mm	30.5	30.5	15.9

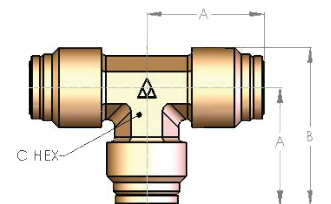

MAQ65-P UNION ELBOW

Part Number	Tube O.D.	A	B	C
MAQ65-P-6	6mm	21.6	28.0	9.5
MAQ65-P-8	8mm	24.1	32.4	11.1

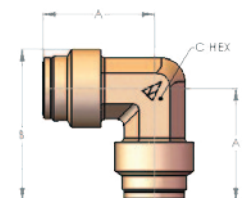

* Made to Order -- consult factory for price and availability.

SERIES MAQ

Brass Push-In Metric Fittings

MAQ66-P FEMALE CONNECTOR

Part Number	Tube O.D.	Female Pipe	A	B
MAQ66-P-4X2 *	4mm	1/8	28.2	14.0
MAQ66-P-4X4 *	4mm	1/4	35.2	32.0
MAQ66-P-6X2 *	6mm	1/8	33.0	29.5
MAQ66-P-6X4 *	6mm	1/4	33.5	19.0
MAQ66-P-8X4 *	8mm	1/4	33.5	19.0
MAQ66-P-8X6 *	8mm	3/8	39.5	36.0

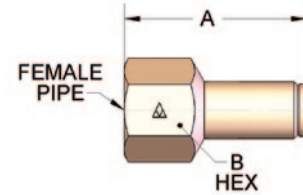

MAQ68-P MALE CONNECTOR

Part Number	Tube O.D.	Pipe (BSPT)	A	B	C
MAQ68-P-4X2 *	4mm	1/8	18.6	3.5	11.0
MAQ68-P-4X4 *	4mm	1/4	23.1	3.5	14.0
MAQ68-P-6X2	6mm	1/8	21.5	5.1	14.0
MAQ68-P-6X4	6mm	1/4	23.1	5.1	14.0
MAQ68-P-8X4	8mm	1/4	25.9	6.0	14.0
MAQ68-P-8X6 *	8mm	3/8	24.5	6.0	19.0
MAQ68-P-10X4 *	10mm	1/4	31.2	7.9	18.0
MAQ68-P-10X6 *	10mm	3/8	31.2	7.9	18.0
MAQ68-P-12X6 *	12mm	3/8	32.0	9.0	18.0
MAQ68-P-12X8 *	12mm	1/2	30.7	10.3	22.0

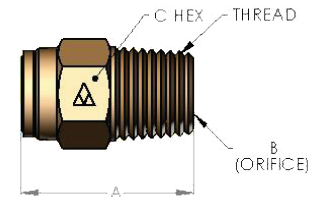

MAQ68-P MALE CONNECTOR WITH "G" THREADS

Part Number	Tube O.D.	Pipe Thread (BSPP)	A	B	C
MAQ68-P-4X0G *	4mm	M5	19.8	2.3	9
MAQ68-P-4X2G *	4mm	1/8	18.4	3.5	14
MAQ68-P-4X4G *	4mm	1/4	19.8	3.5	19
MAQ68-P-6X0G *	6mm	M5	21.6	2.3	12
MAQ68-P-6X2G *	6mm	1/8	20.0	3.5	14
MAQ68-P-6X4G *	6mm	1/4	21.6	5.1	19
MAQ68-P-8X4G *	8mm	1/4	21.6	6.0	19
MAQ68-P-8X6G *	8mm	3/8	24.1	7.1	22
MAQ68-P-10X4G *	10mm	1/4	26.3	7.9	18
MAQ68-P-10X6G *	10mm	3/8	23.2	7.9	22
MAQ68-P-12X4G *	12mm	1/4	27.1	7.9	18
MAQ68-P-12X6G *	12mm	3/8	24.6	9.9	22
MAQ68-P-12X8G *	12mm	1/2	25.2	10.3	27

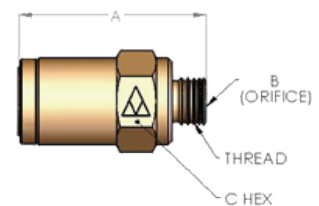

* Made to Order -- consult factory for price and availability.

SERIES MAQ

Brass Push-In Metric Fittings

MAQ69-PS SWIVEL MALE ELBOW

Part Number	Tube O.D.	Pipe (BSPT)	A	B	C	D	E
MAQ69-PS-4X2	4mm	1/8	17.0	22.1	11.0	28.2	9.5
MAQ69-PS-4X4	4mm	1/4	17.0	26.3	14.0	32.4	9.5
MAQ69-PS-6X2	6mm	1/8	20.9	22.4	11.0	29.3	9.5
MAQ69-PS-6X4	6mm	1/4	21.7	27.1	14.0	34.0	9.5
MAQ69-PS-8X4	8mm	1/4	24.0	29.3	14.0	37.6	11.0
MAQ69-PS-8X6	8mm	3/8	24.0	29.9	19.0	38.2	11.0
MAQ69-PS-10X4	10mm	1/4	24.3	29.6	14.0	38.5	12.7
MAQ69-PS-10X6	10mm	3/8	24.3	31.8	19.0	39.9	12.7
MAQ69-PS-12X6	12mm	3/8	26.5	32.5	19.0	42.2	15.9
MAQ69-PS-12X8	12mm	1/2	26.5	37.8	22.0	47.8	15.9

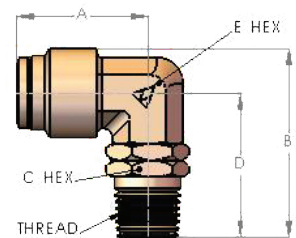

MAQ71-PS SWIVEL MALE RUN TEE

Part Number	Tube O.D.	Pipe (BSPT)	A	B	C	D	E
MAQ71-PS-4X2 *	4mm	1/8	19.7	16.5	11.0	29.7	11.0
MAQ71-PS-4X4 *	4mm	1/4	19.7	16.5	14.0	34.7	14.0
MAQ71-PS-6X2 *	6mm	1/8	26.0	22.5	11.0	28.7	11.0
MAQ71-PS-6X4 *	6mm	1/4	26.0	22.5	14.0	33.7	14.0
MAQ71-PS-8X4 *	8mm	1/4	27.5	24.0	14.0	35.2	14.0
MAQ71-PS-8X6 *	8mm	3/8	27.5	24.0	18.0	35.2	19.0
MAQ71-PS-10X4 *	10mm	1/4	27.0	23.5	14.0	35.2	14.0
MAQ71-PS-10X6 *	10mm	3/8	27.0	23.5	18.0	35.2	19.0
MAQ71-PS-12X6 *	12mm	3/8	30.0	26.5	18.0	37.0	19.0
MAQ71-PS-12X8 *	12mm	1/2	31.0	28.0	22.0	40.0	22.0

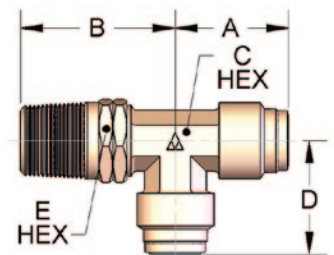

MAQ72-PS SWIVEL MALE BRANCH TEE

Part Number	Tube O.D.	Pipe (BSPT)	A	B	C	D	E
MAQ72-PS-4X2 *	4mm	1/8	19.2	16.0	11.0	29.7	11.0
MAQ72-PS-4X4 *	4mm	1/4	19.2	16.0	14.0	34.7	14.0
MAQ72-PS-6X2 *	6mm	1/8	26.0	22.5	11.0	31.2	11.0
MAQ72-PS-6X4 *	6mm	1/4	26.0	22.5	14.0	36.2	14.0
MAQ72-PS-8X4 *	8mm	1/4	27.0	23.5	14.0	36.7	14.0
MAQ72-PS-8X6 *	8mm	3/8	27.0	23.5	18.0	36.7	19.0
MAQ72-PS-10X4 *	10mm	1/4	27.5	24.0	14.0	35.5	14.0
MAQ72-PS-10X6 *	10mm	3/8	27.5	24.0	18.0	37.5	19.0
MAQ72-PS-12X6 *	12mm	3/8	29.5	26.0	18.0	38.0	19.0
MAQ72-PS-12X8 *	12mm	1/2	33.0	29.0	22.0	38.0	22.0

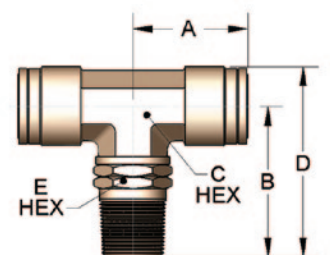

SERIES MAQ

Brass Push-In Metric Fittings

MAQ82-P BULKHEAD UNION

Part Number	Tube O.D.	A	B	C	D	E
MAQ82-P-4	4mm	36.5	12.7	16.0	16.0	7/16-20
MAQ82-P-6	6mm	39.2	22.6	17.0	17.0	1/2-20
MAQ82-P-8	8mm	43.9	22.6	20.0	20.0	5/8-18
MAQ82-P-10	10mm	43.9	22.6	20.0	20.0	3/4-16
MAQ82-P-12	12mm	46.6	19.0	28.5	28.5	1 5/16-16

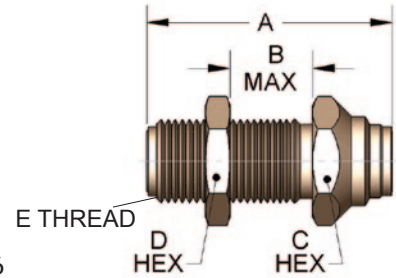

SERIES MAQ-DOT

Metric Air Brake Brass Push-In Fittings



SPECIFICATIONS

Temperature Range:
Recommended Tubing:

-40°F to 250°F
Metric J844

Alkon AQ-DOT Series meet D.O.T. FMVSS 571.106 Air Brake Performance Requirements; SAE J1131, J2494-1 & J2494-3 Air Brake Performance Requirements.

MAQ62-DOT UNION CONNECTOR

Part Number	Tube O.D. 1	A	B
MAQ62-DOT-4	4mm	38.4	9.7
MAQ62-DOT-6	6mm	40.1	11.9
MAQ62-DOT-8	8mm	40.1	14.2
MAQ62-DOT-10	10mm	40.1	17.3
MAQ62-DOT-12	12mm	40.1	19.8

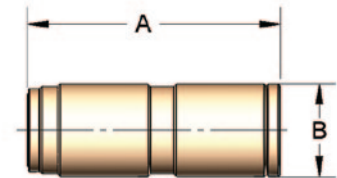

MAQ64-DOT UNION TEE

Part Number	Tube O.D.	A	B	C	D
MAQ64-DOT-6	6mm	21.6	21.6	9.5	27.7
MAQ64-DOT-8	8mm	24.4	24.4	12.7	32.6
MAQ64-DOT-10	10mm	24.4	24.4	12.7	32.6
MAQ64-DOT-12	12mm	25.4	25.4	15.9	35.6

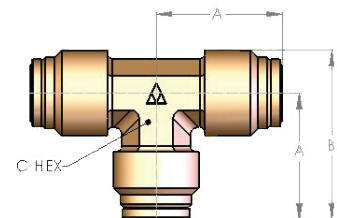

SERIES MAQ-DOT

Metric Air Brake Brass Push-In Fittings

MAQ68-DOT MALE CONNECTOR Metric Tube NPTF Thread

Part Number	Tube O.D.	Pipe (NPTF)	A	B	C
MAQ68-DOT-6X2	6mm	1/8	23.4	3.6	11.1
MAQ68-DOT-6X4	6mm	1/4	24.6	3.6	14.3
MAQ68-DOT-8X2	8mm	1/8	25.7	3.6	14.3
MAQ68-DOT-8X4	8mm	1/4	26.7	5.5	14.3
MAQ68-DOT-8X6	8mm	3/8	26.8	5.5	17.5
MAQ68-DOT-10X4	10mm	1/4	29.2	7.1	17.5
MAQ68-DOT-10X6	10mm	3/8	29.3	7.1	17.5
MAQ68-DOT-12X4	12mm	1/4	32.3	7.9	17.5
MAQ68-DOT-12X6	12mm	3/8	27.7	9.5	17.5

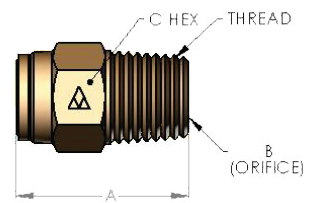

MAQ68-DOT MALE CONNECTOR Metric Tube Metric Thread

Part Number	Tube O.D.	Metric Thread	A	B
MAQ68-DOT-6XM12	6mm	M12	28.8	17.0
MAQ68-DOT-6XM16	6mm	M16	25.6	22.0
MAQ68-DOT-6XM22	6mm	M22	25.6	27.0
MAQ68-DOT-8XM12	8mm	M12	30.0	17.0
MAQ68-DOT-8XM16	8mm	M16	28.1	22.0
MAQ68-DOT-8XM22	8mm	M22	28.1	27.0
MAQ68-DOT-10XM12	10mm	M12	30.68	17.0
MAQ68-DOT-10XM16	10mm	M16	29.3	22.0
MAQ68-DOT-10XM22	10mm	M22	27.4	27.0
MAQ68-DOT-12XM12	12mm	M12	30.8	17.0
MAQ68-DOT-12XM16	12mm	M16	30.3	22.0
MAQ68-DOT-12XM22	12mm	M22	26.2	22.0

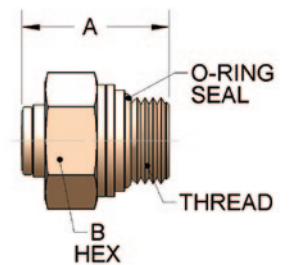

MAQ82-DOT BULKHEAD UNION

Part Number	Tube O.D.	A	B	C	D	E
MAQ82-DOT-4 *	4mm	36.5	12.7	15.8	15.8	7/16-20
MAQ82-DOT-6 *	6mm	39.2	22.6	17.5	17.5	1/2-20
MAQ82-DOT-8 *	8mm	43.9	22.6	20.6	20.6	5/8-19
MAQ82-DOT-10 *	10mm	43.9	22.6	20.6	20.6	3/4-16

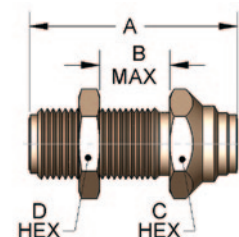

SERIES MAQ-DOT

Metric Air Brake Brass Push-In Fittings

SHAPE CONFIGURATION CHART

Use this chart as a guide when placing your order for the Series MAQ-DOT Metric Air Brake Brass Push-In Fittings.

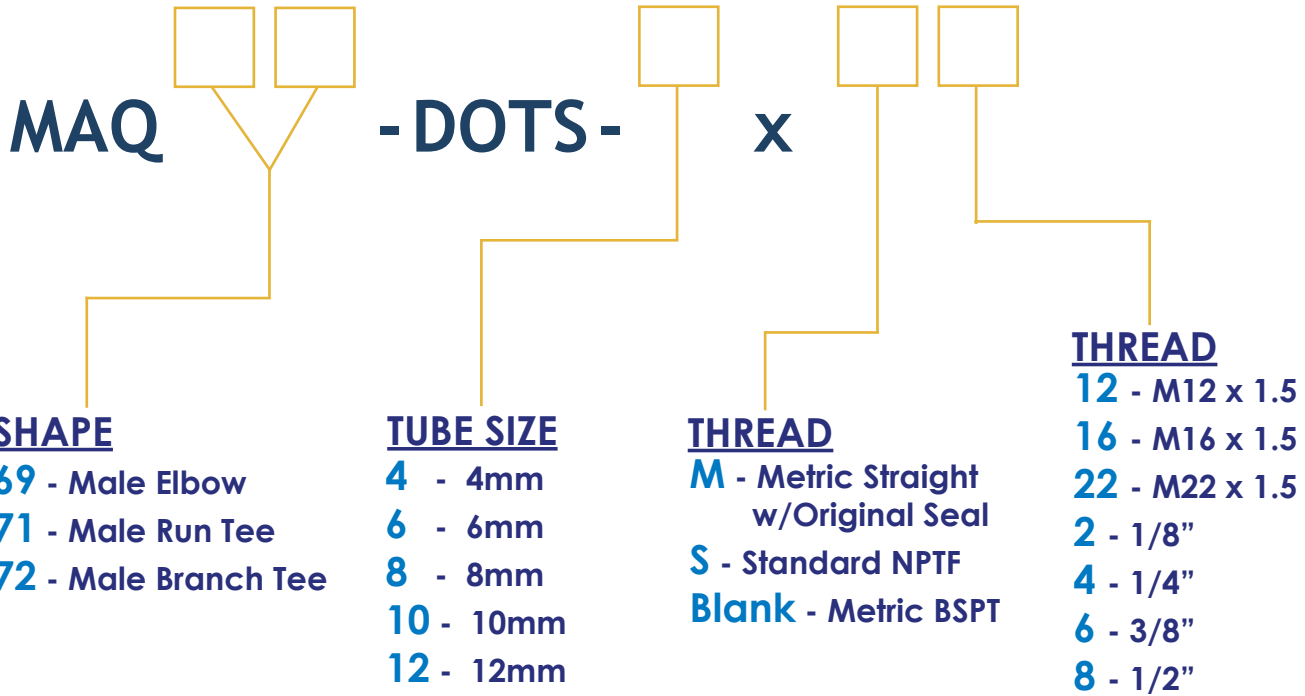

Dimensional data available upon request.



OPTIONS

for AQ and MAQ Series Fittings

Viton® “O” Ring Seals in Series AQ Fittings

Viton® is available from stock in a selected assortment of parts and can be installed in any Series AQ Fitting.

To order, just replace “P” or “PS” in series AQ part number with “V” or “VS”

Consult Alkon for availability of AFLAS, EPR, EPDM and other “O” Ring Seals in Series AQ Fittings.

Viton® is a registered Trademark of DuPont Dow Elastomers.



Nickel Plated Fittings

Available on Series AQ or Series MAQ Fittings

Nickel plated fittings provide service under harsh conditions for many years to come. The lustrous finish will enhance the appearance of any machinery and add a glow of quality. Nickel plated fittings come with pre-applied thread sealant to save installation labor.

To order, just replace “P” or “PS” in series AQ part number with “N” or “NS”



SERIES AP

Brass Tube Fittings for Plastic Tubing



SPECIFICATIONS

Temperature Range Nylon Sleeve: -40° F to 225° F
 Temperature Range Brass Sleeve: -40° F to 325° F
 Material of Shapes (Elbow, Tees): Brass CA 377
 Material of Straights: Brass CA 360

Material of Sleeves: Brass/Nylon

Compatible Tubing: Soft Metal, Polyethylene, Nylon.

AP56-P REDUCING UNION

Part Number	Tube O.D.	A	B	C
AP56-P-6X4	3/8X1/4	1.263	0.895	9/16
AP56-P-8X6 *	1/2X3/8	1.637	1.244	3/4

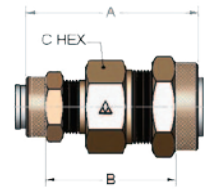

AP59-P CAP

Part Number	Tube O.D.	A
AP59-P-4	1/4	0.500
AP59-P-5 *	5/16	0.531
AP59-P-6	3/8	0.562
AP59-P-8 *	1/2	0.593

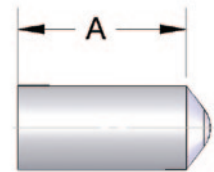

AP60-P PLASTIC SLEEVE

Part Number	Tube O.D.	A
AP60-P-4	1/4	0.322
AP60-P-5	5/16	0.340
AP60-P-6	3/8	0.358
AP60-P-8	1/2	0.400



AP61-B UNIVERSAL NUT AND BRASS SLEEVE ASSEMBLY

Part Number	Tube O.D.	A	B	Thread
AP61-B-2	1/8	0.375	3/8	5/16-24
AP61-B-3	3/16	0.406	7/16	3/8-24
AP61-B-4	1/4	0.343	7/16	3/8-24
AP61-B-5	5/16	0.343	1/2	7/16-24
AP61-B-6	3/8	0.375	9/16	1/2-24
AP61-B-8	1/2	0.421	13/16	11/16-20

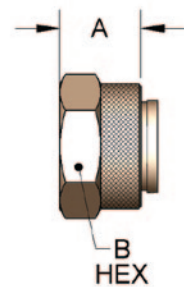

* Made to Order -- consult factory for price and availability.

SERIES AP

Brass Tube Fittings for Plastic Tubing

AP61-P NUT AND PLASTIC SLEEVE ASSEMBLY

Part Number	Tube O.D.	A	B	Thread
AP61-P-4	1/4	0.345	7/16	3/8-24
AP61-P-5	5/16	0.343	1/2	7/16-24
AP61-P-6	3/8	0.365	9/16	1/2-24
AP61-P-8	1/2	0.428	13/16	11/16-20

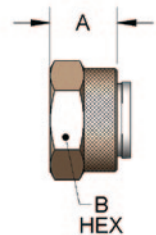

AP61-U NUT ONLY

Part Number	Tube O.D.	A	B	Thread
AP61-U-2	1/8	0.375	3/8	5/16-24
AP61-U-3 *	3/16	0.406	7/16	3/8-24
AP61-U-4	1/4	0.345	7/16	3/8-24
AP61-U-5	5/16	0.355	1/2	7/16-24
AP61-U-6	3/8	0.365	9/16	1/2-24
AP61-U-8	1/2	0.428	13/16	11/16-20

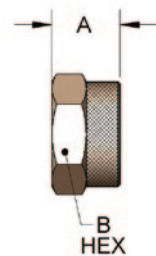

AP62-C UNION TUBE - TO COMPRESSION

Part Number	Tube O.D.	A	B
AP62-C-4 *	1/8	1.250	7/16
AP62-C-5 *	5/16	1.281	1/2
AP62-C-6 *	3/8	1.406	9/16

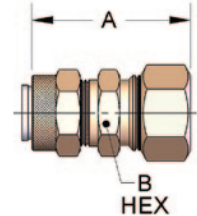

AP62-P UNION

Part Number	Tube O.D.	A	B
AP62-P-2	1/8	1.277	5/16
AP62-P-3	3/16	1.328	7/16
AP62-P-4	1/4	1.241	7/16
AP62-P-5	5/16	1.248	1/2
AP62-P-6	3/8	1.241	9/16
AP62-P-8	1/2	1.601	3/4

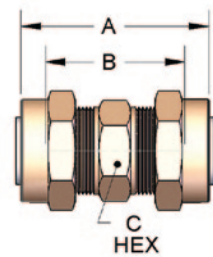

AP64-P UNION

Part Number	Tube O.D.	A	B
AP64-P-2	1/8	0.825	5/16
AP64-P-3	3/16	0.835	5/16
AP64-P-4	1/4	0.766	5/16
AP64-P-5	5/16	0.915	3/8
AP64-P-6	3/8	0.802	3/8
AP64-P-8	1/2	1.14	5/8

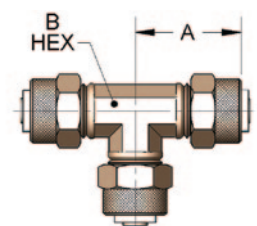

SERIES AP

Brass Tube Fittings for Plastic Tubing

AP66-P FEMALE CONNECTOR

Part Number	Tube O.D.	Female Pipe	A	B
AP66-P-2X2 *	1/8	1/8	1.045	9/16
AP66-P-3X2 *	3/16	1/8	1.060	9/16
AP66-P-3X4 *	3/16	1/4	1.265	11/16
AP66-P-4X2 *	1/4	1/8	1.020	1/2
AP66-P-4X4	1/4	1/4	1.207	5/8
AP66-P-4X6 *	1/4	3/8	1.272	7/8
AP66-P-5X2	5/16	1/8	1.200	1/2
AP66-P-6X4	3/8	1/4	1.177	5/8
AP66-P-8X6	1/2	3/8	1.350	13/16

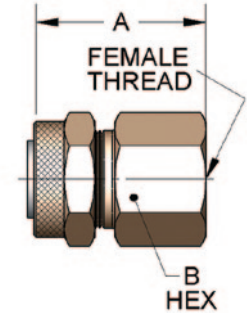

AP68-P MALE CONNECTOR

Part Number	Tube O.D.	Pipe	A	B
AP68-P-2X0 *	1/8	10-32**	0.878	5/16
AP68-P-2X2	1/8	1/8	1.124	7/16
AP68-P-3X2	3/16	1/8	1.133	7/16
AP68-P-4X0	1/4	10-32**	0.864	3/8
AP68-P-4X2	1/4	1/8	1.057	7/16
AP68-P-4X4	1/4	1/4	1.267	9/16
AP68-P-4X6	1/4	3/8	1.332	11/16
AP68-P-5X2	5/16	1/8	1.123	1/2
AP68-P-5X4	5/16	1/4	1.292	9/16
AP68-P-6X2	3/8	1/8	1.083	9/16
AP68-P-6X4	3/8	1/4	1.271	9/16
AP68-P-6X6	3/8	3/8	1.271	11/16
AP68-P-8X4 *	1/2	1/4	1.343	
AP68-P-8X6	1/2	3/8	1.443	11/16
AP68-P-8X8	1/2	1/2	1.674	7/8

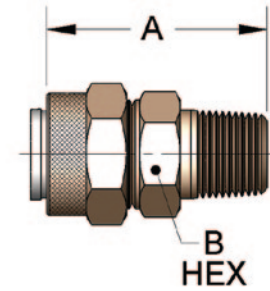

AP69-L EXTRA LONG MALE ELBOW

Part Number	Tube O.D.	Pipe	A	B	C
AP69-L-4X4	1/4	1/4	0.834	1.500	3/8

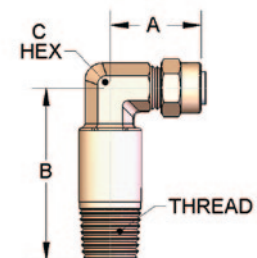

* Made to Order -- consult factory for price and availability. ** Furnished with nylon gasket.

SERIES AP

Brass Tube Fittings for Plastic Tubing

AP69-P MALE ELBOW

Part Number	Tube O.D.	Pipe	A	B	C
AP69-P-2X2	1/8	1/8	0.800	0.689	5/16
AP69-P-3X2	3/16	1/8	0.809	0.690	3/8
AP69-P-4X1 *	1/4	1/16		0.625	0.375
AP69-P-4X2	1/4	1/8	0.830	0.748	3/8
AP69-P-4X4	1/4	1/4	0.882	0.958	3/8
AP69-P-4X6	1/4	3/8	0.954	0.984	1/2
AP69-P-5X2	5/16	1/8	0.894	0.750	3/8
AP69-P-6X2	3/8	1/8	0.865	0.750	3/8
AP69-P-6X4	3/8	1/4	0.943	1.053	1/2
AP69-P-6X6	3/8	3/8	0.912	0.984	1/2
AP69-P-8X6	1/2	3/8	1.197	1.006	5/8
AP69-P-8X8	1/2	1/2	1.197	1.196	5/8

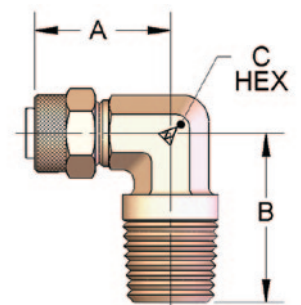

AP70-P FEMALE ELBOW

Part Number	Tube O.D.	Female Pipe	A	B	C
AP70-P-2X2	1/8	1/8	0.900	0.750	3/8
AP70-P-3X2	3/16	1/8	0.905	0.750	3/8
AP70-P-4X2	1/4	1/8	0.889	0.867	3/8
AP70-P-4X4	1/4	1/4	0.970	1.025	1/2
AP70-P-6X4	3/8	1/4	0.960	1.000	1/2
AP70-P-8X6	1/2	3/8	1.140	1.062	5/8

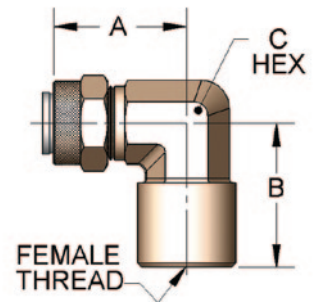

AP71-P MALE RUN TEE

Part Number	Tube O.D.	Pipe	A	B	C
AP71-P-2X2 *	1/8	1/8	0.825	0.655	5/16
AP71-P-3X2 *	3/16	1/8	0.835	0.655	5/16
AP71-P-4X2 *	1/4	1/8	0.895	0.750	3/8
AP71-P-4X4	1/4	1/4	0.926	0.937	7/16
AP71-P-5X2 *	5/16	1/8	0.895	0.750	3/8
AP71-P-6X4	3/8	1/4	0.908	0.949	7/16
AP71-P-8X6 *	1/2	3/8	1.140	1.052	5/8

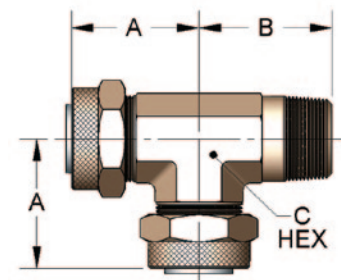

SERIES AP

Brass Tube Fittings for Plastic Tubing

AP72-P MALE BRANCH TEE

Part Number	Tube O.D.	Pipe	A	B	C
AP72-P-2X2 *	1/8	1/8	0.825	0.700	5/16
AP72-P-3X2 *	3/16	1/8	0.835	0.700	5/16
AP72-P-4X2	1/4	1/8	0.895	0.750	3/8
AP72-P-4X4	1/4	1/4	0.927	0.897	7/16
AP72-P-5X2 *	5/16	1/8	0.904	0.745	3/8
AP72-P-6X2	3/8	1/8	0.859	0.750	7/16
AP72-P-6X4	3/8	1/4	0.908	0.897	7/16
AP72-P-8X6 *	1/2	3/8	1.140	1.052	5/8

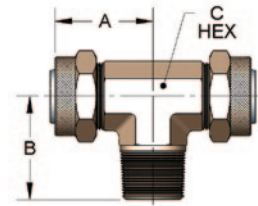

AP77-P FEMALE BRANCH TEE

Part Number	Tube O.D.	Female Pipe	A	B	C
AP77-P-4X2 *	1/4	1/8	0.771	0.937	7/16
AP77-P-4X4 *	1/4	1/4	0.940	0.984	1/2
AP77-P-4X6 *	1/4	3/8	0.893	1.125	5/8

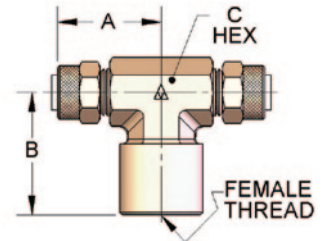

AP79-P UNION REDUCING TEE REDUCING ON BRANCH

Part Number	Tube O.D. 1	Tube O.D. 2	A	B	C
AP79-P-6X4	3/8	1/4	0.802	0.896	3/8

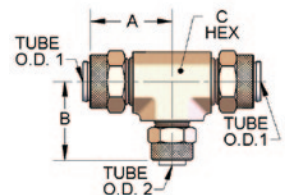

AP82-C BULKHEAD UNION - TO STANDARD COMPRESSION

Part Number	Tube O.D.	A	B	C
AP82-C-4	1/4	1.796	0.375	0.562
AP82-C-6 *	3/8	2.000	0.375	0.687

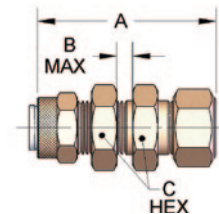

AP82-P BULKHEAD UNION

Part Number	Tube O.D.	A	B	C
AP82-P-4	1/4	1.790	0.312	9/16
AP82-P-5 *	5/16	1.790	0.312	5/8
AP82-P-6	3/8	1.792	0.375	11/16
AP82-P-8 *	1/2	2.262	0.375	7/8

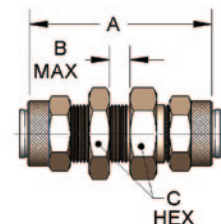

* Made to Order -- consult factory for price and availability.

SERIES AP

Brass Tube Fittings for Plastic Tubing

AP92-P QUICK DISCONNECT FITTING

When tube is disconnected, flow shuts off automatically

Part Number	Tube O.D.	Pipe	A	B
AP92-P-4X2 *	1/4	1/8	1.153	7/16
AP92-P-4X4 *	1/4	1/4	1.332	9/16
AP92-P-5X2 *	5/16	1/8	1.205	1/2
AP92-P-6X4 *	3/8	1/4	1.350	9/16

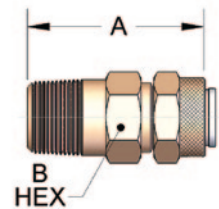

DOUBLE END SHUT-OFF TYPE CHROME PLATED BRASS COUPLERS

AP94-D “AP TO AP”

Part Number	Tube O.D.	Pipe	A
AP94-D-4 *	1/4		3.672
AP94-D-6 *	3/8		3.823

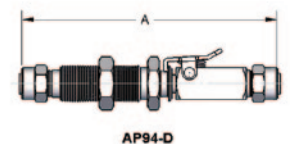

AP98-D “AP” TO MALE P.T.

Part Number	Tube O.D.	Pipe	A
AP98-D-4X2 *	1/4	1/8	2.888
AP98-D-4X4 *	1/4	1/4	2.910
AP98-D-6X4 *	3/8	1/4	3.015

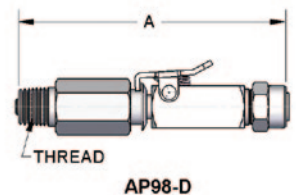

SINGLE END SHUT-OFF TYPE CHROME PLATED BRASS COUPLERS

AP94-P COUPLERS “AP TO AP”

Part Number	Tube O.D.	A
AP94-P-4	1/4	3.000
AP94-P-6 *	3/8	3.562

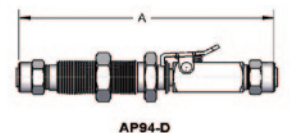

AP98-P COUPLERS “AP” TO MALE P.T.

Part Number	Tube O.D.	Pipe	A
AP98-P-4X2 *	1/4	1/8	2.312
AP98-P-4X4 *	1/4	1/4	2.312
AP98-P-6X4 *	3/8	1/4	2.625

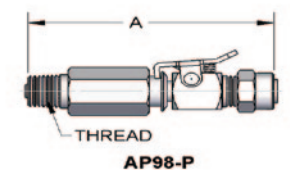

SERIES AP

Brass Tube Fittings for Plastic Tubing

SINGLE END OR DOUBLE END SHUT-OFF TYPE BODY ONLY CHROME PLATED BRASS

WITH "AP" CONNECTION

Part Number	Tube O.D.	A	B	C	D Thread
AP94-B-4	1/4	2.140	0.625	5/8	1/2-24
AP94-B-6 *	3/8	2.232	0.812	13/16	11/16-24

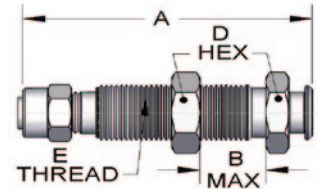

WITH MALE P.T. CONNECTION

Part Number	Tube O.D.	Pipe	A	B
AP98-T-4X2	1/4	1/8	1.320	0.500
AP98-T-4X4	1/4	1/4	1.270	0.562
AP98-T-6X4	3/8	1/4	1.400	0.625

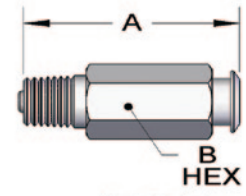

SINGLE END SHUT-OFF TYPE INSERT ONLY CHROME PLATED BRASS WITH "AP" CONNECTION

Part Number	Tube O.D.	Used With	A	B
AP94-M-4	1/4	AP98-T-4X2 AP98-T-4X4	1.693	0.437
AP94-M-6 *	3/8	AP98-T-6X4	1.925	0.562

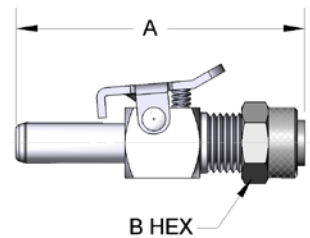

DOUBLE END SHUT-OFF TYPE INSERT ONLY CHROME PLATED BRASS WITH "AP" CONNECTION

Part Number	Tube O.D.	Used With	A	B
AP94-MD-4	1/4	AP98-T-4X2 AP98-T-4X4	2.402	0.437
AP94-MD-6 *	3/8	AP98-T-6X4	2.460	0.562

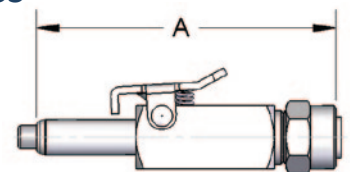

APC61-P NUT AND PLASTIC SLEEVE ASSEMBLY CHROME PLATED BRASS

Part Number	Tube O.D.	A	B	C
APC61-P-4	1/4	0.345	7/16	3/8-24
APC61-P-6	3/8	0.365	9/16	1/2-24

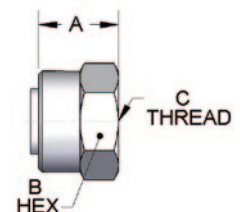

SERIES 60

Compression Fittings

SPECIFICATIONS

Temperature Range:

Pressure:

-40° F to 325° F
250 PSI Normal
400 PSI Maximum

Material of Shapes:

Material of Sleeves:

Compatible Tubing:

Forged SAE CA377 Brass

SAE C360 Brass

Copper, Brass, Aluminum,
and Thermoplastic

60 COMPRESSION SLEEVE

Part Number	Tube O.D.
60-4	1/4
60-6	3/8
60-8	1/2



65 COMPRESSION UNION ELBOW

Part Number	Tube O.D.
65-4	1/4
65-6	3/8
65-8	1/2



61 COMPRESSION NUT

Part Number	Tube O.D.
61-4	1/4
61-6	3/8
61-8	1/2



66 COMPRESSION FEMALE CONNECTOR

Part Number	Tube O.D.	Pipe
66-42	1/4	1/8
66-44	1/4	1/4
66-64	3/8	1/4
66-66	3/8	3/8



62 COMPRESSION UNION

Part Number	Tube O.D.
62-4	1/4
62-6	3/8
62-8	1/2
62-10	5/8



68 COMPRESSION MALE CONNECTOR

Part Number	Tube O.D.	Pipe
68-42	1/4	1/8
68-44	1/4	1/4
68-46	1/4	3/8
68-62	3/8	1/8
68-64	3/8	1/4
68-66	3/8	3/8
68-68	3/8	1/2
68-84	1/2	1/4
68-86	1/2	3/8
68-88	1/2	1/2
68-108	5/8	1/2



64 COMPRESSION UNION TEE

Part Number	Tube O.D.
64-4	1/4
64-6	3/8
64-8	1/2



SERIES 60

Compression Fittings



69 COMPRESSION MALE ELBOW

Part Number	Tube O.D.	Pipe
69-42	1/4	1/8
69-44	1/4	1/4
69-46	1/4	3/8
69-62	3/8	1/8
69-64	3/8	1/4
69-66	3/8	3/8
69-68	3/8	1/2
69-84	1/2	1/4
69-86	1/2	3/8
69-88	1/2	1/2
69-106	5/8	3/8
69-108	5/8	1/2



70 COMPRESSION FEMALE ELBOW

Part Number	Tube O.D.	Pipe
70-42	1/4	1/8
70-44	1/4	1/4
70-64	3/8	1/4
70-88	1/2	1/2



71 COMPRESSION MALE RUN TEE

Part Number	Tube O.D.	Pipe
71-42	1/4	1/8
71-64	3/8	1/4
71-86	1/2	3/8
71-108	5/8	1/2



72 COMPRESSION MALE BRANCH TEE

Part Number	Tube O.D.	Pipe
72-42	1/4	1/8
72-44	1/4	1/4
72-64	3/8	1/4
72-86	1/2	3/8
72/88	1/2	1/2



CUSTOMIZED FITTINGS

CUSTOMIZED FITTINGS

Alkon Corporation has the flexibility to offer you standard “out of the catalog” components, as well as customized products to fit your needs.

We are large enough to handle any order, yet we are small enough to still be able to give you personal service.

Customized fittings are usually the result of combining other fittings such as pipe or barbs with Series AQ Push-In fittings. This eliminates the number of leakage paths, reduces inventory items and saves assembly labor.

Examples shown above illustrate combinations with barbs, male and female pipe threads in the same fittings, different tube outside diameters in the same fitting, different pipe thread connections and 45° elbows.

- Customized fittings are available in brass and nickel plated brass.
- O-ring material and thread sealant options are available.
- Customized products are only limited by the imagination of the designer.

Contact Alkon for no-charge design assistance.

SERIES 100

Pipe Fittings

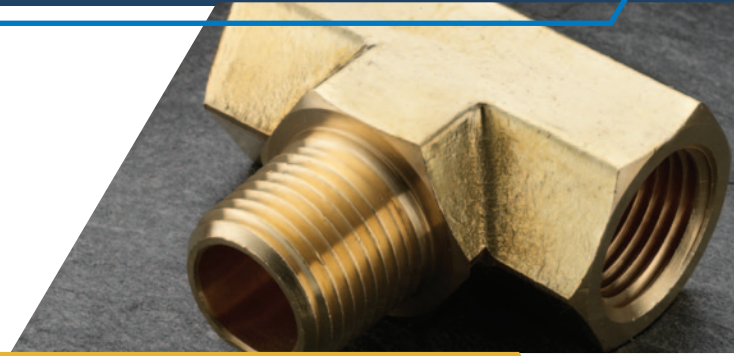

SPECIFICATIONS

Pressure: 3000 PSI
 Material of Shapes: Forged SAE CA377 Brass
 Material of Straights: SAE C360 Brass

Meets all SAE brass pipe fittings standards

100A 90° UNION ELBOW

Part Number	PT 1	Min. Orifice Size	A	B. Hex
100A-2X2	1/8	0.328	0.546	9/16
100A-4X4	1/4	0.438	0.781	11/16
100A-6X6	3/8	0.563	0.840	15/16
100A-8X8	1/2	0.702	1.090	1-1/16

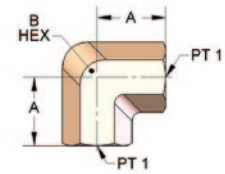

101A UNION TEE

Part Number	PT 1	Min. Orifice Size	A	B. Hex
101A-2X2	1/8	0.328	0.546	9/16
101A-4X4	1/4	0.438	0.781	11/16
101A-6X6	3/8	0.563	0.840	15/16
101A-8X8	1/2	0.702	1.09	1-1/16

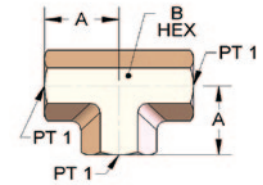

102A CROSS

Part Number	PT 1	Min. Orifice Size	A	B
102A-2	1/8	0.328	0.546	9/16
102A-4	1/4	0.438	0.781	11/16
102A-6	3/8	0.563	0.840	15/16
102A-8	1/2	0.702	1.090	1-1/16

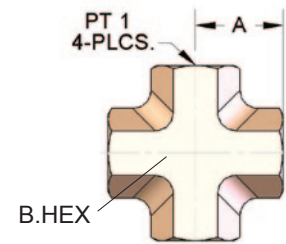

103A COUPLING

Part Number	PT 1	A	C HEX
103A-2	1/8	0.750	0.562
103A-4	1/4	1.120	0.750
103A-6	3/8	1.125	0.875
103A-8	1/2	1.500	1.062

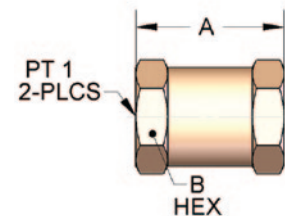

SERIES 100

Pipe Fittings

104A UNION

Part Number	PT 1	Min. Orifice Size	A	B HEX
104A-2	1/8	0.750	1.265	15/16
104A-4	1/4	1.120	1.468	
104A-6	3/8	1.125	1.625	

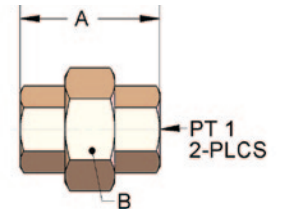

106A FORGED MALE ELBOW

Part Number	PT 1	A	B HEX
106A-2	1/8	0.690	5/16
106A-4	1/4	1.000	1/2
106A-6	3/8	1.060	5/8
106A-8	1/2	1.280	11/16

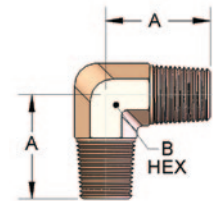

107A BRANCH TEE

Part Number	PT 1	A	B	C
107A-2	1/8	0.55	0.82	9/16
107A-4	1/4	0.78	1.08	11/16
107A-6	3/8	0.84	1.23	15/16
107A-8	1/2	1.09	1.49	1-1/16

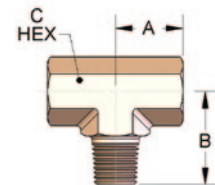

108A CAP

Part Number	Female PT 1	A	B HEX
108A-2	1/8	0.500	0.563
108A-4	1/4	0.750	0.750
108A-6	3/8	0.875	0.875
108A-8	1/2	1.063	1.063

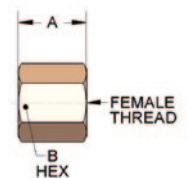

109A SQUARE-HEAD PLUG

Part Number	PT 1	A	B Square
109A-2	1/8	0.709	9/32
109A-4	1/4	0.813	3/8
109A-6	3/8	0.849	7/16
109A-8	1/2	1.078	9/16

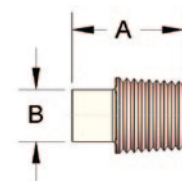

109AL COUNTERSUNK HEX-HEAD PLUG

Part Number	PT 1	A
109AL-2	1/8	0.300
109AL-4	1/4	0.400
109AL-6	3/8	0.400
109AL-8	1/2	0.550

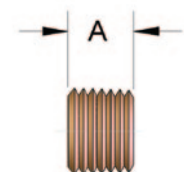

SERIES 100

Pipe Fittings

110 BUSHING

Part Number	PT 1	PT 2	Min. Orifice Size	A	B HEX
110A-4X2	1/4	1/8	0.328	0.75	9/16
110A-6X2	3/8	1/8	0.328	0.75	11/16
110A-6X4	3/8	1/4	0.438	0.75	3/4
110A-8X2	1/2	1/8	0.328	1.00	7/8
110A-8X4	1/2	1/4	0.438	1.00	7/8
110A-8X6	1/2	3/8	0.563	1.00	7/8
110A-12X4	3/4	1/4	0.438	1.00	1-1/8
110A-12X6	3/4	3/8	0.563	1.00	1-1/8
110A-12X8	3/4	1/2	0.702	1.00	1-1/8

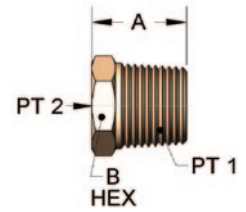

111A LOCK NUT

Part Number	PT 1	A	B HEX
111A-2	1/8	0.187	5/8
111A-4	1/4	0.250	11/16
111A-6	3/8	0.250	15/16
111A-8	1/2	0.250	1-1/8

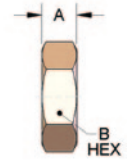

112A 90° CLOSE NIPPLE

Part Number	PT 1	Min. Orifice Size	A
112A-2	1/8	0.281	0.750
112A-4	1/4	0.375	1.125
112A-6	3/8	0.500	1.125
112A-8	1/2	0.625	1.500
112A-12	3/4	0.750	1.500

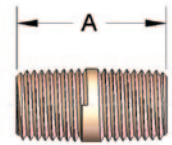

113A LONG NIPPLE

Part Number	PT 1	Min. Orifice Size	A	Part Number	PT 1	Min. Orifice Size	A
113A-2X24	1/8	0.265	1.500	113A-6X24	3/8	0.500	1.500
113A-2X32	1/8	0.265	2.000	113A-6X32	3/8	0.500	2.000
113A-2X40	1/8	0.265	2.500	113A-6X40	3/8	0.500	2.500
113A-2X48	1/8	0.265	3.000	113A-6X48	3/8	0.500	3.000
113A-2X56	1/8	0.265	3.500	113A-6X56	3/8	0.500	3.500
113A-4X24	1/4	0.375	1.500	113A-8X24	1/2	0.625	1.500
113A-4X32	1/4	0.375	2.000	113A-8X32	1/2	0.625	2.000
113A-4X40	1/4	0.375	2.500	113A-8X40	1/2	0.625	2.500
113A-4X48	1/4	0.375	3.000	113A-8X48	1/2	0.625	3.000
113A-4X56	1/4	0.375	3.500	113A-8X56	1/2	0.625	3.500

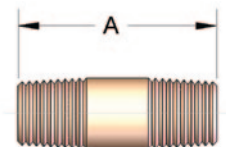

SERIES 100

Pipe Fittings

116A 90° STREET ELBOW

Part Number	PT 1	Min. Orifice Size	A	B	C
116A-2X2	1/8	0.219	0.480	0.812	9/16
116A-4X2	1/4	0.219	0.718	0.900	11/16
116A-4X4	1/4	0.312	0.718	1.031	11/6
116A-6X6	3/8	0.438	0.780	1.187	15/16
116A-8X8	1/2	0.562	1.090	1.437	1-1/16

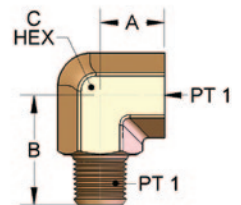

117A SLOTTED HEAD PLUG

Part Number	PT 1	A
117A-2	1/8	0.320
117A-4	1/4	0.469



119A REDUCING ADAPTER

Part Number	Female PT 1	Female PT 2	A	B HEX
119A-4X2	1/4	1/8	0.970	3/4
119A-6X4	3/8	1/4	1.160	7/8
119A-8X4	1/2	1/4	1.280	1-1/16
119A-8X6	1/2	3/8	1.375	1-1/16
119A-12X8	3/4	1/2	1.750	1-3/8

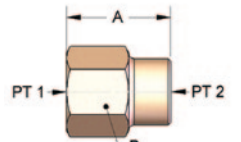

120A ADAPTER

Part Number	Female PT 1	Female PT 2	Min. Orifice Size	A	B HEX
120A-2X2	1/8	1/8	0.219	0.906	9/16
120A-4X2	1/4	1/8	0.219	1.063	3/4
120A-4X4	1/4	1/4	0.312	1.250	3/4
120A-6X2	3/8	1/8	0.219	1.070	7/8
120A-6X4	3/8	1/4	0.312	1.250	7/8
120A-6X6	3/8	3/8	0.438	1.250	7/8
120A-8X6	1/2	3/8	0.438	1.469	1-1/16
120A-8X8	1/2	1/2	0.562	1.660	1-1/16

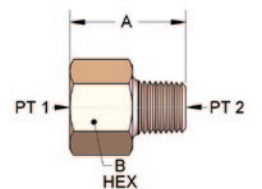

121A HEX-HEAD PLUG

Part Number	PT 1	A	B HEX
121A-2	1/8	0.531	7/16
121A-4	1/4	0.750	9/16
121A-6	3/8	0.772	11/16
121A-8	1/2	0.969	7/8
121A-12	3/4	1.062	1-1/16

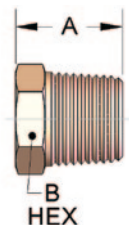

SERIES 100

Pipe Fittings

122 HEX NIPPLE

Part Number	PT 1	PT 2	Min. Orifice Size	A	B HEX
122A-2X2	1/8	1/8	0.219	0.906	7/16
122A-4X2	1/4	1/8	0.219	1.190	9/16
122A-4X4	1/4	1/4	0.312	1.375	9/16
122A-6X4	3/8	1/4	0.312	1.406	11/16
122A-6X6	3/8	3/8	0.438	1.406	11/16
122A-8X4	1/2	1/4	0.312	1.620	7/8
122A-8X6	1/2	3/8	0.438	1.620	7/8
122A-8X8	1/2	1/2	0.562	1.812	7/8

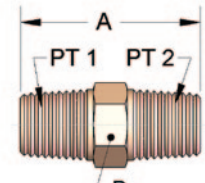

124A 45° STREET NIPPLE

Part Number	PT 1	Min. Orifice Size	A	B	C HEX
124A-2X2	1/8	0.219	0.750	0.687	9/16
124A-4X4	1/4	0.312	0.875	0.781	11/16
124A-6X6	3/8	0.438	1.000	0.875	15/16
124A-8X8	1/2	0.562	1.125	1.218	1-1/16

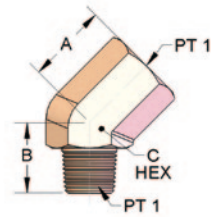

127A STREET TEE

Part Number	PT 1	Min. Orifice Size	A	B	C HEX
127A-2	1/8	0.219	0.550	0.820	9/16
127A-4	1/4	0.313	0.781	1.156	11/16
127A-6	3/8	0.438	0.840	1.230	15/16
127A-8	1/2	0.562	1.090	1.490	1-1/16

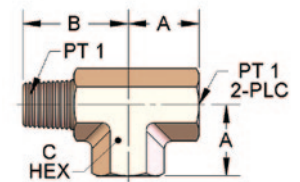

129A BULKHEAD ADAPTER

Part Number	Female PT 1	PT 2	Min. Orifice Size	A	B HEX
129A-2X24	1/8	5/8-18	0.328	1.500	7/8
129A-4X15	1/4	3/4-16	0.421	0.940	1"
129A-4X24	1/4	3/4-16	0.440	1.500	1"
129A-6X21	3/8	1-14	0.562	1.310	1-1/8
129A-8X24	1/2	1 1/8-14	0.700	1.500	1-1/4

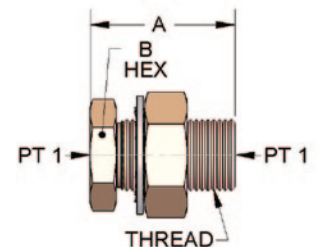

SERIES 29

Barb Adapters

SPECIFICATIONS

Temperature Range: -40° F to 325° F
 Material of Shapes: Forged SAE CA377 Brass
 Intended for use with: Hose Clamp (plastic tubing or rubber hose). Barb size is hose I.D.

MALE CONNECTOR

Part Number	Hose	Pipe
29-22	1/8	1/8
29-32	3/16	1/8
29-42	1/4	1/8
29-44	1/4	1/4
29-46	1/4	3/8
29-52	5/16	1/8
29-54	5/16	1/4
29-64	3/8	1/4
29-66	3/8	3/8
29-68	3/8	1/2
29-84	1/2	1/4
29-86	1/2	3/8
29-88	1/2	1/2



FEMALE CONNECTOR

Part Number	Hose	Pipe
29F-42	1/4	1/8
29F-44	1/4	1/4
29F-64	3/8	1/4
29F-66	3/8	3/8
29F-84	1/2	1/4
29F-86	1/2	3/8
29F-88	1/2	1/2

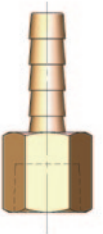

HOSE SPLICER

Part Number	Hose	Pipe
29S-4	1/4	1/4
29S-5	5/16	5/16
29S-6	3/8	3/8
29S-8	1/2	1/2



MALE ELBOW FORGING

Part Number	Hose	Pipe
29E-42	1/4	1/8
29E-44	1/4	1/4
29E-64	3/8	1/4
29E-66	3/8	3/8
29E-84	1/2	1/4
29E-86	1/2	3/8
29E-88	1/2	1/2

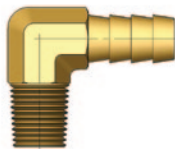

BEADED ELBOW

Part Number	Hose	Pipe
29B-84	1/2	1/4



MISTING APPLICATIONS

3/8" Nickel Plated Fittings

Fittings designed for misting system, agricultural and human cooling.

**MISTING
APPLICATIONS**



AQ62-N-6 STRAIGHT UNION CONNECTOR

AQ64-N-6 UNION TEE CONNECTOR

AQ65-N-6 90° ELBOW UNION CONNECTOR

AQ68-N-6X6 MALE CONNECTOR

AQ68-N-6X4 MALE CONNECTOR

S2853N UNION CONNECTOR WITH #10-24 NOZZLE PORT

Additional shapes and sizes available upon request. Special configuration developed upon request.

SERIES NQ-NTA

Air Brake Brass Compression Fittings

SPECIFICATIONS

Temperature Range: -40° F to 325° F
 Pressure: 200 PSI Nominal/400 PSI Max
 Material of Shapes: Forged SAE CA377 Brass
 Material of Straights: Extruded SAE C360 Brass

Meets SAE J246, J1131 Air Brake standards and all DOT standards.
 Fittings to be used with SAE J844 Tubing.

NQ54-NTA COMPRESSION 45° MALE ELBOW

Part Number	Tube O.D.	Pipe Thread
NQ54-NTA-4X2 *	1/4	1/8
NQ54-NTA-4X4 *	1/4	1/4
NQ54-NTA-6X4 *	3/8	1/4
NQ54-NTA-6X6 *	3/8	3/8
NQ54-NTA-8X6 *	1/2	3/8
NQ54-NTA-8X8	1/2	1/2
NQ54-NTA-10X8 *	5/8	1/2



NQ60-NTA COMPRESSION SLEEVE

Part Number	Tube O.D.
NQ60-NTA-4	1/4
NQ60-NTA-6	3/8
NQ60-NTA-8	1/2
NQ60-NTA-10 *	5/8
NQ60-NTA-12 *	3/4



NQ61-NTA COMPRESSION NUT

Part Number	Tube O.D.
NQ61-NTA-4 *	1/4
NQ61-NTA-6 *	3/8
NQ61-NTA-8 *	1/2
NQ61-NTA-10 *	5/8
NQ61-NTA-12 *	3/4



SERIES NQ-NTA

Air Brake Brass Compression Fittings

NQ62-NTA COMPRESSION UNION

Part Number	Tube O.D.
NQ62-NTA-4	1/4
NQ62-NTA-6	3/8
NQ62-NTA-8	1/2
NQ62-NTA-10 *	5/8
NQ62-NTA-12 *	3/4

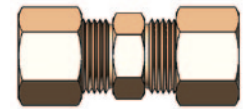

NQ64-NTA COMPRESSION NUT

Part Number	Tube O.D.
NQ64-NTA-4 *	1/4
NQ64-NTA-6 *	3/8
NQ64-NTA-8 *	1/2
NQ64-NTA-10 *	5/8

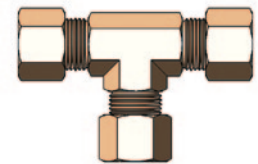

NQ65-NTA COMPRESSION UNION ELBOW

Part Number	Tube O.D.
NQ65-NTA-4 *	1/4
NQ65-NTA-6 *	3/8
NQ65-NTA-8 *	1/2

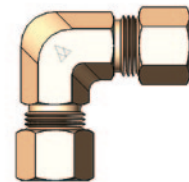

NQ66-NTA COMPRESSION FEMALE CONNECTOR

Part Number	Tube O.D.	Female Pipe Thread
NQ66-NTA-4X2 *	1/4	1/8
NQ66-NTA-4X4 *	1/4	1/4
NQ66-NTA-6X4 *	3/8	1/4
NQ66-NTA-6X6 *	3/8	3/8

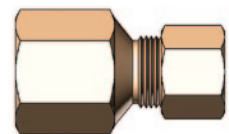

* Made to Order -- consult factory for price and availability.

SERIES NQ-NTA

Air Brake Brass Compression Fittings

NQ68-NTA COMPRESSION MALE CONNECTOR

<i>Part Number</i>	<i>Tube O.D.</i>	<i>Pipe Thread</i>
NQ68-NTA-4X2	1/4	1/8
NQ68-NTA-4X4 *	1/4	1/4
NQ68-NTA-4X6 *	1/4	3/8
NQ68-NTA-6X2 *	3/8	1/8
NQ68-NTA-6X4	3/8	1/4
NQ68-NTA-6X6	3/8	3/8
NQ68-NTA-6X8 *	3/8	1/2
NQ68-NTA-8X4	1/2	1/4
NQ68-NTA-8X6	1/2	3/8
NQ68-NTA-8X8	1/2	1/2
NQ68-NTA-10X6	5/8	3/8
NQ68-NTA-10X8	5/8	1/2
NQ68-NTA-12X8	3/4	1/2
NQ68-NTA-12X12	3/4	3/4

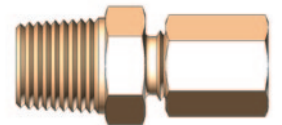

NQ69-NTA COMPRESSION MALE ELBOW

<i>Part Number</i>	<i>Tube O.D.</i>	<i>Pipe Thread</i>
NQ69-NTA-4X2	1/4	1/8
NQ69-NTA-4X4	1/4	1/4
NQ69-NTA-4X6	1/4	3/8
NQ69-NTA-6X2	3/8	1/8
NQ69-NTA-6X4	3/8	1/4
NQ69-NTA-6X6	3/8	3/8
NQ69-NTA-6X8	3/8	1/2
NQ69-NTA-8X4	1/2	1/4
NQ69-NTA-8X6	1/2	3/8
NQ69-NTA-8X8	1/2	1/2
NQ69-NTA-10X6	5/8	3/8
NQ69-NTA-10X8	5/8	1/2
NQ69-NTA-12X8	3/4	1/2
NQ69-NTA-12X12	3/4	3/4

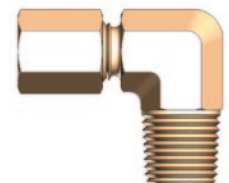

NQ70-NTA COMPRESSION FEMALE ELBOW

<i>Part Number</i>	<i>Tube O.D.</i>	<i>Female Pipe Thread</i>
NQ70-NTA-4X2	1/4	1/8
NQ70-NTA-4X4	1/4	1/4
NQ70-NTA-6X4	3/8	1/4
NQ70-NTA-8X8	1/2	1/2

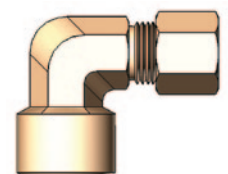

* Made to Order -- consult factory for price and availability.

SERIES NQ-NTA

Air Brake Brass Compression Fittings

NQ71-NTA COMPRESSION MALE RUN TEE

<i>Part Number</i>	<i>Tube O.D.</i>	<i>Pipe Thread</i>
NQ71-NTA-4X2	1/4	1/8
NQ71-NTA-6X2	3/8	1/8
NQ71-NTA-6X4	3/8	1/4
NQ71-NTA-8X6	1/2	3/8
NQ71-NTA-8X8	1/2	1/2
NQ71-NTA-10X8	5/8	1/2

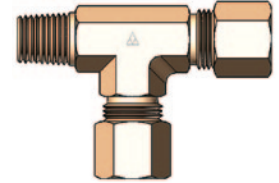

NQ72-NTA COMPRESSION MALE BRANCH TEE

<i>Part Number</i>	<i>Tube O.D.</i>	<i>Pipe Thread</i>
NQ72-NTA-4X2	1/4	1/8
NQ72-NTA-4X4	1/4	1/4
NQ72-NTA-6X2	3/8	1/8
NQ72-NTA-6X4	3/8	1/4
NQ72-NTA-6X6	3/8	3/8
NQ72-NTA-8X6	1/2	3/8
NQ72-NTA-8X8	1/2	1/2
NQ72-NTA-10X8	5/8	1/2

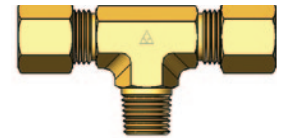

NQ82-NTA COMPRESSION BULKHEAD UNION

<i>Part Number</i>	<i>Tube O.D.</i>
NQ82-NTA-4	1/4
NQ82-NTA-6	3/8
NQ82-NTA-8	1/2



SERIES AP310

Angle & In-Line Needle Valves



MATERIALS

Forged Brass Bodies
O-Ring Packaging
Brass Handle and Stem
Brass Nuts with Plastic Sleeves

For use with polyethylene, nylon,
or soft metal tubing.
Panel mount available upon request.

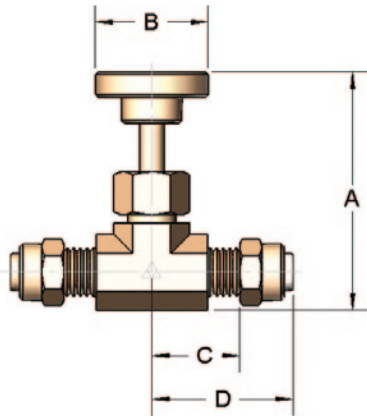

Globe Type
AP to AP

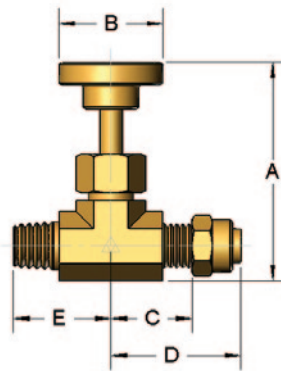

Globe Type
AP to NPT

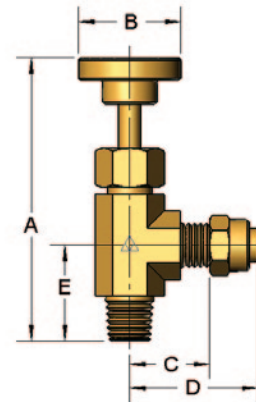

Angle Type
AP to NPT

AP NEEDLE VALVES

GLOBE TYPE "AP TO AP"

Part Number	Inlet O.D.	Outlet O.D.	CV	A Open	A Close	B	C	D	Orifice
AP310-C-4 *	1/4	1/4	0.25	1.496	1.378	0.866	0.748	0.984	0.142
AP310-C-6 *	3/8	3/8	0.56	1.772	1.614	1.142	0.827	1.063	0.220

GLOBE TYPE "AP to NPT"

Part Number	Inlet O.D.	Outlet O.D.	CV	A Open	A Close	B	C	D	Orifice
AP311-C-4X2 *	1/8	1/4	0.25	1.496	1.378	0.866	0.748	0.748	0.126
AP311-C-4X4 *	1/4	1/4	0.25	1.496	1.378	0.866	0.748	0.748	0.142
AP311-C-6X4 *	1/4	3/8	0.56	1.772	1.614	1.142	0.827	0.945	0.173

ANGLE TYPE "AP TO NPT"

Part Number	Inlet O.D.	Outlet O.D.	CV	A Open	A Close	B	C	D	Orifice
AP312-C-4X2 *	1/8	1/4	0.36	1.496	1.260	0.866	0.630	0.689	0.126
AP312-C-4X4 *	1/4	1/4	0.36	1.496	1.378	0.866	0.630	0.748	0.126
AP312-C-6X2 *	1/8	3/8	0.81	1.693	1.378	0.866	0.669	0.842	0.205

SERIES J

Angle & In-Line Flow Control, Needle & Check Valves



JAQ ANGLE FLOW CONTROL WITH SERIES "AQ" TUBE CONNECTIONS

Part Number	Tube O.D.	Pipe	A	B	C	D	E
JAQ-5/32X2	5/32	1/8 NPT	1.73	1.38	0.75	0.63	9/16
JAQ-4X2	1/4	1/8 NPT	1.73	1.51	0.75	0.63	9/16
JAQ-4X4	1/4	1/4 NPT	2.11	1.62	1.04	0.75	11/16
JAQ-6X4	3/8	1/4 NPT	2.11	1.59	1.04	0.75	11/16
JAQ-6X6	3/8	3/8 NPT	2.19	1.85	1.06	0.88	7/8
JAQ-8X8	1/2	3/8 NPT	2.75	1.98	1.43	1.125	1.0

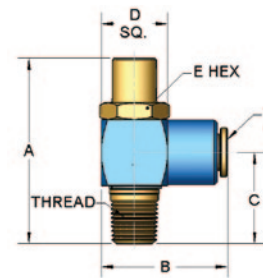

JPT ANGLE FLOW CONTROL WITH FEMALE PIPE THREADS

Part Number	P.T. 1	P.T. 2	A	B	C	D	E
JPT-2X2	1/8 NPT	1/8 NPT	1.73	1.23	0.75	0.63	9/16
JPT-4X2	1/4 NPT	1/8 NPT	1.73	1.43	0.69	0.75	9/16
JPT-4X4	1/4 NPT	1/4 NPT	2.10	1.43	1.03	0.75	11/16
JPT-6X4	3/8 NPT	1/4 NPT	2.10	1.48	0.97	0.88	11/16
JPT-6X6	3/8 NPT	3/8 NPT	2.19	1.66	1.06	0.88	7/8
JPT-6X8	3/8 NPT	1/2 NPT	2.74	1.85	1.43	1.13	1.0
JPT-8X8	1/2 NPT	1/2 NPT	2.75	2.01	1.43	1.13	1.0

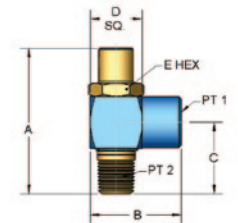

JC IN-LINE CHECK VALVE

Brass Body	Nickel Plated	Pipe Size NPTF	A	B	Orifice	Needle Full Open
JC1	JC1N	1/8	1.468	0.562	0.206	0.64
JC2	JC2N	1/4	1.937	0.687	0.281	1.35
JC3	JC3N	3/8	2.312	0.875	0.421	3.22
JC4	JC4N	1/2	3.250	1.187	0.515	4.96
	JC6N	3/4	4.000	1.750	0.718	9.00
	JC8N	1	4.000	1.750	0.718	9.20



SERIES J

Angle & In-Line Flow Control, Needle & Check Valves

JF FLOW CONTROL VALVE

MODEL NO.			VALVE DIMENSIONS (inches)							ORIFICE ON			CV FACTOR	
Brass Body	Nickel Plated	Pipe Size NPTF	A	B	C	D	E	F	G Hex Size	Check	Needle	Check	Needle Full Open	Approx. Weight
JF1	JF1N	1/8	1.468	0.562	0.913	1.803	0.250	0.687	3/32	0.602	0.125	0.60	0.30	0.19
JF2	JF2N	1/4	1.937	0.687	1.232	2.000	0.250	0.687	3/32	0.281	0.187	1.30	0.60	0.28
JF3	JF3N	3/8	2.312	0.875	1.545	2.531	0.300	0.937	3/32	0.421	0.250	2.85	1.08	0.54
JF4	JF4N	1/2	3.250	1.187	2.117	3.218	0.375	1.250	3/32	0.515	0.375	4.96	1.75	1.75
	JF6N	3/4	4.000	1.750	2.625	3.906	0.375	1.250	3/32	0.718	0.500	9.00	3.20	2.32
	JF8N	1	4.000	1.750	2.635	3.906	0.375	1.250	3/32	0.718	0.500	9.20	3.20	2.20

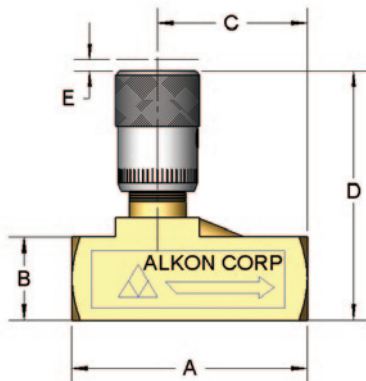

JN IN-LINE NEEDLE VALVE

MODEL NO.			VALVE DIMENSIONS (inches)							CV FACTOR	
Brass Body	Nickel Plated	Pipe Size NPTF	A	B	C	D	E	F	G Hex Size	Orifice	Needle Full Open
JN1	JN1N	1/8	1.468	0.562	0.913	1.803	0.250	0.687	3/32	0.125	0.30
JN2	JN2N	1/4	1.937	0.687	1.232	2.000	0.250	0.687	3/32	0.187	0.60
JN3	JN3N	3/8	2.312	0.875	1.545	2.531	0.300	0.937	3/32	0.250	1.08
JN4	JN4N	1/2	3.250	1.187	2.117	3.218	0.375	1.250	3/32	0.375	1.75
	JN6N	3/4	4.000	1.750	2.625	3.906	0.375	1.250	3/32	0.500	3.20
	JN8N	1	4.000	1.750	2.635	3.906	0.375	1.250	3/32	0.500	3.20

INDUSTRIAL TUBING

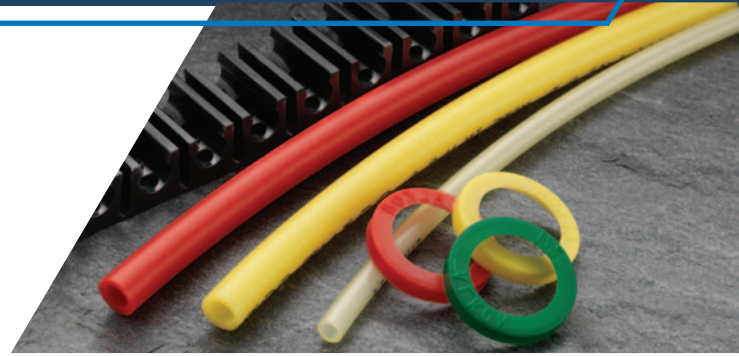

POLYETHYLENE TUBING

RESISTANT TO SOLVENTS & CHEMICALS, TEMP: -100°F to 175°F, NATURAL: FDA APPROVED, LIGHT WEIGHT AND MORE FLEXIBLE

Part Number	Tube O.D.	Wall Thickness	Min. Bend Radius	Working Pressure	Burst PSI @ 75°F
AP22	1/8	.020	1/2	125	500
APP5/32	5/32	.025	5/8	125	500
AP33	3/16	.030	3/4	125	500
AP44	1/4	.040	1	100	400
AP55	5/16	.062	1-1/8	150	600
AP66	3/8	.062	1-1/4	88	350
AP88	1/2	.062	2-1/2	62	250

POLYURETHANE TUBING

RESISTANT TO KINKS, ABRASIONS, & CHEMICALS, TEMP: -40°F to 180°F, APPLICATIONS INCLUDE VACUUM, FUEL LINES, ROBOTICS, HIGHLY FLEXIBLE TUBING

Part Number	Tube O.D.	Wall Thickness	Min. Bend Radius	Working Pressure	Burst PSI @ 75°F
PUR22	1/8	.031	5/16	145	580
PUR5/32	5/32	.031	7/16	90	360
PUR33	3/16	.062	5/8	80	320
PUR44	1/4	.045	5/8	90	370
PUR44H	1/4	.062	5/8	100	400
PUR66	3/8	.062	1-1/4	95	380
PUR88	1/2	.062	1-7/8	55	220

NYLON 12 TUBING

TEMP: -60°F to 250°F, APPLICATIONS INCLUDE AIR, CHEMICALS, LUBRICANT AND LOW PRESSURE HYDRAULICS

Part Number	Tube O.D.	Wall Thickness	Min. Bend Radius	Working Pressure	Burst PSI @ 75°F
NY22	1/8	.016	1/2	250	1000
NY5/32	5/32	.025	5/8	250	1000
NY33	3/16	.031	5/8	250	1000
NY44	1/4	.035	1	250	1000
NY66	3/8	.050	1-3/4	250	1000
NY88	1/2	.062	2-3/8	250	1000

INDUSTRIAL TUBING

METRIC NYLON 12 TUBING

Packaged 25 meters per package (82 ft.)

Part Number	Tube O.D.	Wall Thickness	Min. Bend Radius	Working Pressure	Burst PSI @ 75 °F
MNY4	4mm	.65mm	14mm	250	1000
MNY6	6mm	1.0mm	21mm	250	1000
MNY8	8mm	1.0mm	28mm	250	1000
MNY10	10mm	1.25mm	35mm	250	1000
MNY12	12mm	1.25mm	45mm	250	1000



TUBING ACCESSORIES

TUBING ACCESSORIES

TUBE RACKS

Part Number	Tube Size	Max # Tubes
AP02-P-4	1/4	2
AP10-P-4	1/4	10
AP07-P-6	3/8	7
AP06-P-8	1/2	6

TUBE CUTTER

Part Number
AP-TC

AQ COLOR COORDINATED SNAP-ON IDENTIFICATION CAPS

Used in coordination with colored plastic tubing for simplification in plumbing

Part Number	Tube O.D.
AQCAP-2 *	1/8"
AQCAP-5/32 *	5/32"
AQCAP-3 *	3/16"
AQCAP-4 *	1/4"
AQCAP-6 *	3/8"
AQCAP-8 *	1/2"
AQCAP-10 *	5/8"

* Add color code from below after size designation

EXAMPLE:

AQCAP-4R, RED COLOR SNAP ON ID CAP

Part Color	Color Code
Blue	B
Black	BL
Green	GN
Red	R
Orange	O
Violet	V
Yellow	Y
Gray	GR

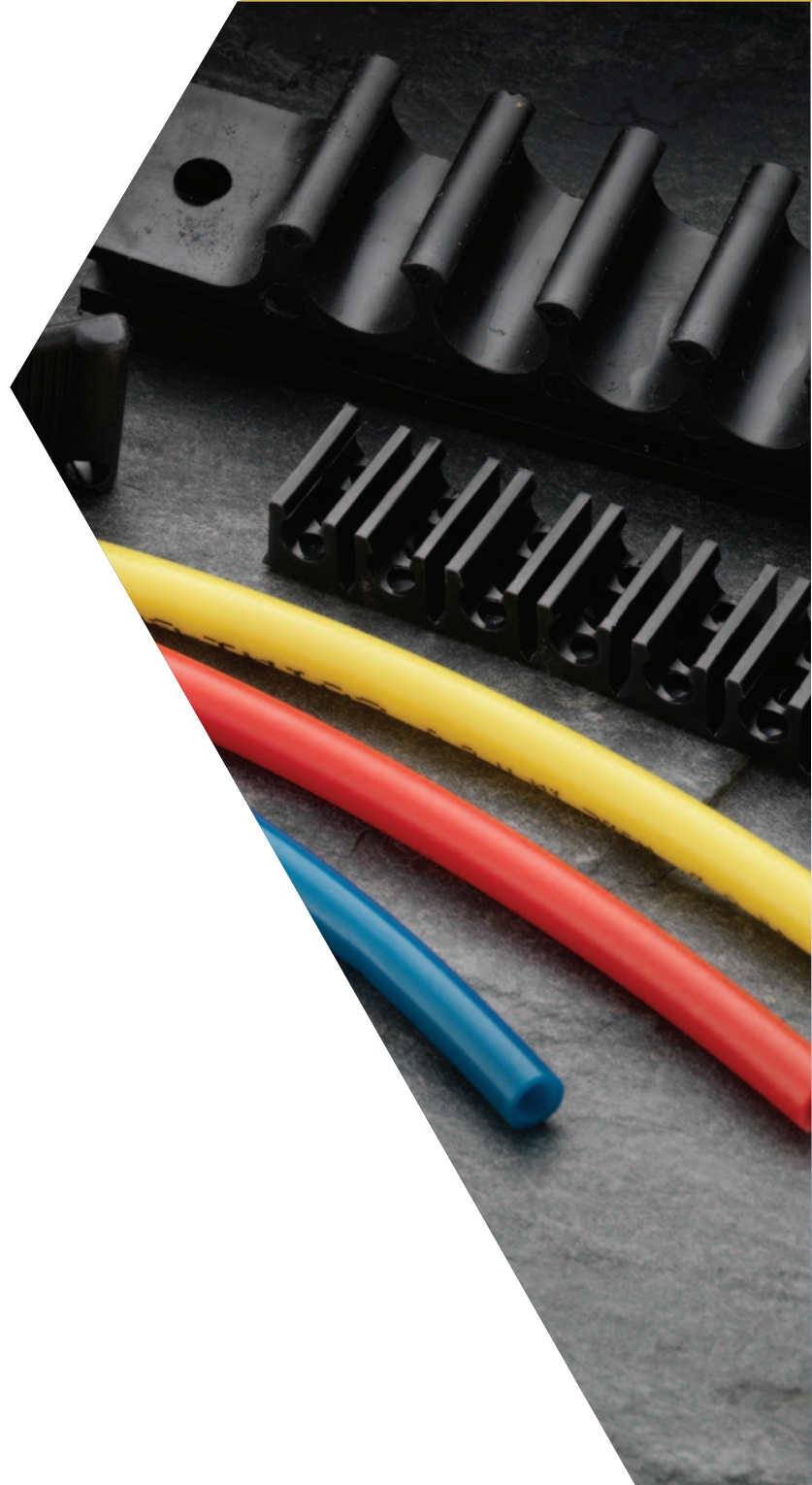

EMERGENCY REPAIR KITS

EMERGENCY REPAIR KITS

With the Alkon DOT Emergency Repair Kit, fixing a malfunction has never been easier. Once the problem is located, use the tube cutter to make a clean cut, then simply push to connect the tubing into an Alkon fitting to create an air-tight seal. No further tools are necessary!

We understand the value of a quick, effective, do-it-yourself repair to ensure that not only will you get right back on the road, but more importantly, that your machine will be running as smoothly as ever.

Considering everything you can plan for, don't let something out of your control ruin your entire trip. Equip your vehicle with the Alkon DOT Emergency Repair Kit and you'll have nothing but the open road ahead.

PART NUMBER

AQ62-DOT-KIT-1

INCLUDES

Reusable Push-In Unions for 1/4", 3/8" & 1/2" tubing and tube cutter.

AQ62-DOT-KIT-2

Reusable Push-In Unions for 5/32", 1/4", 3/8" & 5/8" tubing and tube cutter.



MANIFOLDS

with Pre-Installed Push-In Fitting Cartridges

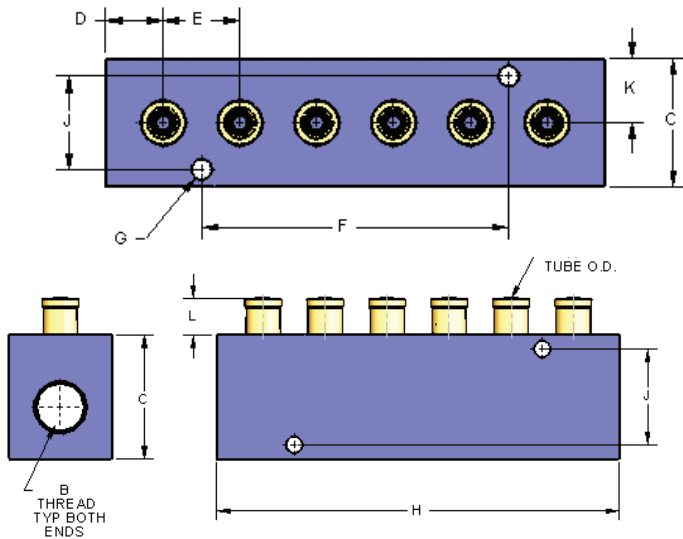

At Alkon we offer custom manifolds for DOT applications. Please consult our factory if you need more information.

MQ22 MANIFOLDS WITH PUSH-IN FITTINGS

Part No.	No. Outlets	A-Tube O.D.	B-Pipe Thread	C	D	E	F	G	H	J	K	L
MQ22-2X4-4	4	1/8	1/4	1.00 Sq.	0.50	0.75	1.50	0.17	3.25	0.70	0.50	0.47
MQ22-2X4-6	6	1/8	1/4	1.00 Sq.	0.50	0.75	3.00	0.17	4.75	0.70	0.50	0.47
MQ22-2X4-8	8	1/8	1/4	1.00 Sq.	0.50	0.75	4.50	0.17	6.25	0.70	0.50	0.47
MQ22-2X4-10	10	1/8	1/4	1.00 Sq.	0.50	0.75	6.00	0.17	7.75	0.70	0.50	0.47
MQ22-5/32X4-4	4	5/32	1/4	1.00 Sq.	0.50	0.75	1.50	0.17	3.25	0.70	0.50	0.47
MQ22-5/32X4-6	6	5/32	1/4	1.00 Sq.	0.50	0.75	3.00	0.17	4.75	0.70	0.50	0.47
MQ22-5/32X4-8	8	5/32	1/4	1.00 Sq.	0.50	0.75	4.50	0.17	6.25	0.70	0.50	0.47
MQ22-5/32X4-10	10	5/32	1/4	1.00 Sq.	0.50	0.75	6.00	0.17	7.75	0.70	0.50	0.47
MQ22-3X4-4	4	3/16	1/4	1.00 Sq.	0.50	0.75	1.50	0.17	3.25	0.70	0.50	0.57
MQ22-3X4-6	6	3/16	1/4	1.00 Sq.	0.50	0.75	3.00	0.17	4.75	0.70	0.50	0.57
MQ22-3X4-8	8	3/16	1/4	1.00 Sq.	0.50	0.75	4.50	0.17	6.25	0.70	0.50	0.57
MQ22-3X4-10	10	3/16	1/4	1.00 Sq.	0.50	0.75	6.00	0.17	7.75	0.70	0.50	0.57
MQ22-4X6-4	4	1/4	3/8	1.13 Sq.	0.63	0.75	1.50	0.18	3.50	0.85	0.56	0.67
MQ22-4X6-6	6	1/4	3/8	1.13 Sq.	0.63	0.75	3.00	0.18	5.00	0.85	0.56	0.67
MQ22-4X6-8	8	1/4	3/8	1.13 Sq.	0.63	0.75	4.50	0.18	6.50	0.85	0.56	0.67
MQ22-4X6-10	10	1/4	3/8	1.13 Sq.	0.63	0.75	6.00	0.18	8.00	0.85	0.56	0.67
MQ22-6X6-4	4	3/8	3/8	1.13 Sq.	0.63	0.75	1.50	0.18	3.50	0.85	0.56	0.95
MQ22-6X6-6	6	3/8	3/8	1.13 Sq.	0.63	0.75	3.00	0.18	5.00	0.85	0.56	0.95
MQ22-6X6-8	8	3/8	3/8	1.13 Sq.	0.63	0.75	4.50	0.18	6.50	0.85	0.56	0.95
MQ22-6X6-10	10	3/8	3/8	1.13 Sq.	0.63	0.75	6.00	0.18	8.00	0.85	0.56	0.95