

EAT•N

Aeroquip

Fluid Conveyance Products

Master Catalog

Hose

Hose Fittings

Adapters & Tube Fittings

Accessories/Equipment



Eaton
14615 Lone Oak Road
Eden Prairie, MN 55344
USA
Tel: 952 937-9800
Fax: 952 974-7722
www.hydraulics.eaton.com

Eaton
20 Rosamond Road
Footscray
Victoria 3011
Australia
Tel: (61) 3 9319 8222
Fax: (61) 3 9318 5714

Eaton
Dr.-Reckeweg-Str. 1
D-76532 Baden-Baden
Germany
Tel: (49) 7221 682-0
Fax: (49) 7221 682-788



Aeroquip

© 2005 Eaton Corporation
All Rights Reserved
Printed in USA
Document No. A-H00V-MC001-E
Supersedes JA316H
January 2005



**The most innovative
manufacturer of fluid
conveyance products
in the world.**

Over the years, Eaton has developed industry-leading innovative products such as the Quick Disconnect Coupling, the Reusable Fitting for hydraulic hose, Hi-Temperature AQP hose, Flexmaster, ORS (O-Ring Seal hydraulic fittings), Bruiser Abrasion Resistant Hose Cover for hydraulic hose and STC® (Snap-To-Connect Fittings). These are just a few of the trend-setting products that we have introduced.





A-MEFI-MC002-E

STC

Snap-To-Connect Provides Leak-Free Connections in a Snap

The broadest range of threadless connectors in the industry!

Eaton's patented technology is extremely successful in various rigorous mobile applications.



Design Features

- Positive round-wire style latching mechanism
- Swivels for installation (in absence of pressure)
- Low-profile; compact design
- Elastomeric o-ring seal – available in many materials

Benefits:

- One-hand connections with no assembly tools allows easy access to confined areas
- Eliminates cross-threading, over or undertorquing, and hose twisting
- Resists contamination
- Easy disconnection with release tool

Applications:

- Truck/bus platforms, construction and agricultural equipment

Specifications:

- Connections from 3/8" - 1"

Pressures:

- Up to 345 bar (5000 psi)

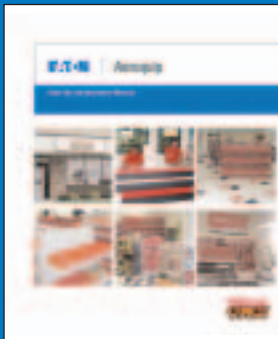

A-DIOV-TM002-E

Express Vans and Stores

Mobile Start-up and Operations

We Bring the Product To You!!



Downtime is a costly fact. The question is how long are you willing to wait to replace that blown hydraulic hose? With Eaton's Aeroquip Express that downtime can be significantly reduced.

Aeroquip Express is a program to assist you in getting the highest quality Aeroquip brand hydraulic hose and fittings in the least amount of time. Whether it is at one of our Aeroquip Express Hose Centers, or on-site from one of our Aeroquip Express



Hose Vans, you're guaranteed the highest quality product along with excellent service.

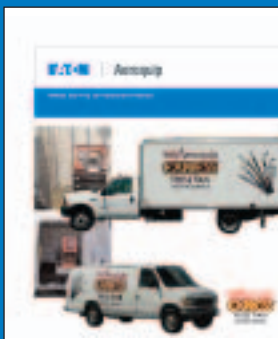

A-DIOV-TM003-E

Hose Cover Materials

Whatever your application, we've got you covered.

Ultra flexible neoprene – A proprietary blend of polymers that when compared to competitive standard covers, offer the ultimate in flexibility without sacrificing abrasion-resistance.

Abrasion resistant nitrile-pvc – Offering all of the advantages of high nitrile-content compounds with the improved abrasion resistance of pvc. Outstanding ozone, UV, chemical, fuel, and oil resistance. The performance of Eaton nitrile-pvc throughout the rated temperature range is second-to-none.

AQP – Eaton's premier high temperature, wide compatibility compound. AQP is in a class of its own.

BRUISER – Simply stated, the most abrasion resistant cover in the world. Eaton was the first hose manufacturer in the world to utilize a UHMW polymer for hose covers.

BRUISER

Abrasion-Resistant Polymer-Covered Hose

BRUISER hose was designed to work where hydraulic hose is subjected

to constant abuse and abrasion from:

- Hose-to-machine
- Hose-to-hose
- Hose-to-environment

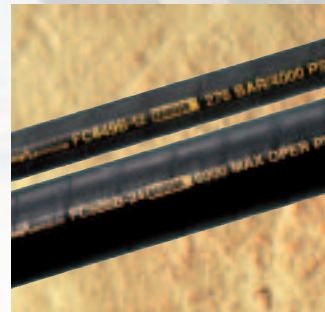

Best Abrasion Resistant Hose in the Industry!

Features:

- Ultra-high molecular weight polyethylene outer covering material (same polymer as used on dump truck liners and snow ski bottoms)
- Slick and shiny appearance

Benefits:

- Highest abrasion resistance of any known polymer covered hose material
- The lower coefficient of friction surface promotes faster installation and routing thus lowers overall installation costs

- Lowers hose assembly costs by eliminating the need to install abrasion resistant sleeving
- Reduces costly downtime by preventing abrasion-related hose failures



A-HOAO-MC001-E



A-HOOV-MR001-E



A-HOMM-MC001-E

MatchMate Plus®

The 3 Minute Crimp Hose Assembly System.

With Eaton's Aeroquip MatchMate Plus crimp hose assembly system,

you can make a factory-standard assembly in as few as three minutes... featuring a global fitting designs that's available worldwide.



The process of matching and mating hose with fittings is greatly simplified with the new MatchMate Plus system.

Colored rings on the hose layline match the design and number of rings on its corresponding fitting type. The crimp machine "mates" the two parts through the use of color-coded dies.

When the mating procedure is complete, you have a perfect hose assembly. You benefit by reduced downtime, less scrap and minimal operator training.

Global Fittings

The MatchMate Plus crimp system features Eaton's new one-piece global fitting. You can select from a variety of Through-the-Cover (TTC)

fitting designs and global fittings which offer you higher standard pressures, cool-down leakage control, improved hose bend radii and worldwide availability.

Together, global products and MatchMate Plus bring you the 3 minute crimp hose assembly system. It's the simplest way to replace hydraulic hose assemblies.



A-MEFI-MC001-E

Global Spiral TTC Fittings

One-Piece Fittings

One-piece through-the-cover spiral hose fittings for easy assembly



Features:

- Through-the-cover crimp
- One-piece nipple design
- One-piece fitting
- Stress-relief design
- Heavy wall thickness
- Modern micro-alloy steel
- Tapered through-hole
- Global design
- Stenciled socket
- Operating pressure to 6000 psi

Benefits:

- Skiving not required, saves time in assembly
- Stronger design, no braze joints
- Easier to assemble
- Maximizes durability
- Heavy-duty construction for heavy-duty applications
- Maximizes fatigue life
- Improves flow characteristics
- Global availability
- Hose insertion depth
- Perfect for hydrostatic drives and other demanding applications
- Available in -12, -16, -20, -24 and -32
- Multiple configurations and jump sizes to fit a wide array of applications

E-Z Clip™ System

Connections Made Easy

The E-Z Clip System is designed for assembly with Aeroquip GH134 Multi-Refrigerant hose. Its engineered connection exceeds SAE J2064 and has been vibration and impulse tested.

Flexible hose lines offer many advantages over rigid tubing including routing ease, vibration absorption, sound deadening and the ability to accommodate movement of connected components.

Benefits:

- No guess work
- No leaking crimps
- No power supply needed
- As easy to use as a pair of pliers
- Easy to use in confined areas



GH134

Multi-Refrigerant Hose



Features:

- Internal polyamide veneer tube
- Synthetic-rubber backing layer
- Stabilized, synthetic braided reinforcement
- Chlorobutyl rubber cover
- E-Z Clip fittings

Benefits:

- Excellent effusion resistance
- Maximum resistance to moisture ingress
- Extended service performance
- Superior flexibility
- Assured coupling integrity, exceeds SAE J2064 performance

AQP Hose

Long-Lasting

Eaton's AQP family of hose is scientifically superior to any hose on the market today.

Materially different, AQP hose is constructed with elastomeric materials

that carry the U.S. Patent No. 4,366,746. There's nothing quite like it!

An Eaton team of chemists and engineers made a major breakthrough with the development of AQP hose. Thousands of compounds were developed and discarded to reach the discovery of the patented, scientifically superior AQP elastomeric material.

Years of laboratory testing and in-the-field performance verification have proven its unique superiority.

Prove it for yourself.

Features:

- Long-lasting service
- Extreme temperature range
- Fluid compatibility
- Versatility
- Reduces inventory
- Practically nonexistent shelf aging



A-HOAC-MC001-E



A-HOAO-MC001-E





M-HYOV-MR001-E2

System Supplier

Mobile and Industrial Hydraulics

Lift. Dig. Haul. Cut. Groove...day in and day out. This is the work of Eaton

Hydraulics products and systems. Engineered for reliable, continuous performance in the world's most demanding mobile and industrial applications.



Mobile Applications

Pumps, motors, valves, transmissions, cylinders, controls, hose and fittings, provide reliable performance in agricultural environments.

Construction

Eaton hydraulic components provide functionality and durability for construction applications.

Material Handling

Eaton hydraulic systems provide precise control and the solutions required for material handling use.

Utility

Eaton is the desired supplier of hydraulic components and hydraulic systems to a large range of utility vehicles.

Forestry

Eaton hydraulics are the reliable answer for control, power, and durability in forestry applications.

Mining

Eaton is the preferred choice for many of the auxiliary systems on mining equipment.



M-HYOV-MR001-E2

Training

Knowledge is Power

And nowhere can your team strengthen its knowledge more than with Eaton

Fluid Power Training. Attendees can save their company significant costs by reducing unplanned downtime and maximizing the

effectiveness of planned downtime.



Each year, more than 2,500 people attend training at Eaton Fluid Power Training Centers in Eden Prairie, Minnesota, Maumee, Ohio, and Wehrheim, Germany, or through customized on-site programs worldwide. Our field and industry specialists combine 140 years of experience in fluid power and education, with the impressive legacy of Vickers and Aeroquip Training.

Our training team delivers valuable, practical insight about design, contamination and troubleshooting of hydraulic and pneumatic circuits. The Maumee facility is furnished with two fully equipped labs, which are complemented by two innovative classrooms for a thoroughly integrated learning experience. Eaton Fluid Power Training offers more than 15 top-line, hands-on courses for

industrial and mobile applications – with other programs and resource materials available for home study. Eaton Fluid Power Training is ideal for maintenance personnel, supervisors, engineers, and even purchasing agents.

For more information visit (www.eatonhydraulics.com/training) or call 800-413-8809 (US), or 49 (0)6081 103344 (Germany).

Table of Contents

Part Number Index				3-8
Terms				9
Hose Application Reference Symbols				10
Specialty & Truck Hose Styles				20-34
HOSE: Heater & Coolant - FC252, FC352 Airbrake - 2550/2554, 2570, FC629, FC829 Railroad Airbrake - 1531/1531A	Airbrake, Fuel, Oil, & 100R5 - FC355, FC350, FC650, FC699, FC234, 2651, 303/302A, 1503, FC300	LPG (UL & CGA) - FC321, CR170	PTFE - 2807, FC807, FC465, 2808, FC469, FC363, FC364, FC563 SOCKETLESS™ - 2575, FC332, FC647, 2556/2565	
Low & Medium Pressure Hose Styles				34-49
HOSE: 100R4 / Suction - FC619, 2661 100R6 & Low Pressure Fabric Braided - FC466, FC498, FC598, 2580, 2583	100R1, 100R1AT, EN853 1SN - FC211, 2681, GH663, GH194, FC194	1 Wire EPDM - FC611 2 Wire EPDM - FC693 100R16 - FC310, FC510 Constant Pressure 3000 PSI - FC639, GH681, FC839B	Constant Pressure 4000 PSI - FC849, FC849B 100R2, 100R2AT, EN 853 2SN - FC212, GH120, 2766, FC735, 2781, GH781, GH793, GH195, FC195	
High Pressure Hose Styles				49-57
HOSE: Four Spiral EPDM - FC636 AQP™ Hi-Temp Spiral - FC323, FC324, FC325	100R12 - GH493, FC659, FC136, FC736 100R11 - FC254	100R13 - FC273, FC273B EN856 4SH - GH506 EN856 6SP - GH466	100R15 - FC606, FC606B 10,000 PSI JACK HOSE - FC579	
Hose Fittings (Crimp & Reusable)				62-189
FITTINGS: OTC, TTC™, TTC12, Global Spiral TTC, Spiral Single Skive,	Spiral Internal Skive, PTFE Crimp, Suction Hose Fittings, 100R5 Reusable, 100R5 Crimp,	FC310 & FC510 Reusable, 100R2 Skive Type Reusable, 100R2 TTC Reusable,	Spiral Skive Reusable, Socketless, Power Steering & Airbrake, PTFE Reusable	
Adapters & Tube Fittings				190-293
ORS-TF, ORS Braze, ORS/O-Ring Boss, ORS-NPTF, ORS/SAE 37° Flare, ORS/ORS, ORS Accessories, Pipe/Pipe, Pipe/SAE 37° Flare,	Pipe/45° Flare, Pipe/SAE O-Ring Boss, Pipe/Braze & Weld, SAE 37° (JIC) Flare Union, SAE 45° Flare Union, SAE O-Ring/37° Flare,	SAE Split Flange/ORS, SAE Split Flange/37° Flare, SAE Split Flange/ SAE Split Flange, Braze & Weld/Split Flange, Braze & Weld/37° Flare,	SAE Flareless/37° Union, Flare & Flareless, Specials, Metric Thread, ISO6149, BSPP Thread, BSPT Thread, JIS 30° Thread, O-Rings, Versil•Flare™, Ermeto	
Accessories & Assembly instructions				294-326
Protective Coils, Sleeves, Clamps, Firesleeve, Nylon Abrasion Sleeve,	Hose Cleaning System, Heavy Duty Hose Support Clamps,	Hose Insertion Gages, Hose Protectors, Hose Spacers, Hose Looms,	Assembly Instructions	
Hose Assembly Equipment				327-342
FT1380, FT1380P, FT1390, ET1000, Portable Reusable Assembly Machine,	Production Reusable Assembly Machine, Assembly Mandrels,	Cut-off Saws, Skiving Tools, Hose Proof Test Stands		
Appendices				343-380
Technical Data, Fluid Compatibility, SAE Recommended Practices, Flow Capacity Pressure Drop	Chart, Service Life Routing Installation Instructions, Analyzing Hose Failures, How to Identify and Measure Fluid	Connectors, Hydraulic Tubing Info. Fitting Assembly Torque Values		

Part Number Index

PART NUMBER	PAGE	PART NUMBER	PAGE	PART NUMBER	PAGE	PART NUMBER	PAGE
1A*BF*	87	1AR*FRA*	75	1B*FLG*	84	1G*DS*	92
1A*BFA*	88	1AR*FRB*	76	1B*JF*	94	1G*DSA*	93
1A*BFB*	89	1AR*FRC*	77	1B*JM*	88	1G*DSB*	93
1A*BP*	90	1AR*MB*	73	1B*KF*	95	1G*EK*	94
1A*BT*	89	1AR*MJ*	72	1B*KS*	96	1G*FL*	80
1A*DK*	92	1AR*MP*	66	1B*KSA*	96	1G*FLA*	81
1A*DL*	90	1AT*BF*	87	1B*KSB*	96	1G*FLB*	82
1A*DLA*	91	1AT*BFA*	88	1B*SL*	78	1G*FLG*	84
1A*DLB*	91	1AT*BFB*	89	1BA*FJ*	68	1G*JF*	94
1A*DS*	92	1AT*BT*	89	1BA*FJA*	69	1G*JM*	88
1A*DSA*	93	1AT*DK*	92	1BA*FJB*	70	1G*KF*	95
1A*DSB*	93	1AT*DL*	90	1BA*FJC*	71	1G*KS*	96
1A*EK*	94	1AT*DLA*	91	1BA*FR*	74	1G*KSA*	96
1A*FL*	80	1AT*DLB*	91	1BA*FRA*	75	1G*KSB*	96
1A*FLA*	81	1AT*FL*	80	1BA*FRB*	76	1G*SL*	78
1A*FLB*	82	1AT*FLA*	81	1BA*FRC*	77	1GA*FJ*	68
1A*FLD*	83	1AT*FLB*	82	1BA*FS*	73	1GA*FJA*	69
1A*FLG*	84	1AT*FLD*	83	1BA*MB*	73	1GA*FJB*	70
1A*JF*	94	1AT*FLE*	83	1BA*MJ*	72	1GA*FJC*	71
1A*JM*	88	1AT*JF*	94	1BA*MP*	66	1GA*FR*	74
1A*KF*	95	1AT*JM*	88	1BA*MR*	77	1GA*FRA*	75
1A*KS*	96	1AT*KF*	95	1E*BF*	101	1GA*FRB*	76
1A*KSA*	96	1AT*SL*	78	1E*BFA*	101	1GA*FRC*	77
1A*KSB*	96	1AV*FJ*	68	1E*BFB*	101	1GA*FS*	73
1A*SL*	78	1AV*FJA*	69	1E*CT*	99	1GA*MB*	73
1AA*FJ*	68	1AV*FJB*	70	1E*CTA*	100	1GA*MF*	78
1AA*FJA*	69	1AV*FJC*	71	1E*CTB*	100	1GA*MFA*	79
1AA*FJB*	70	1AV*FR*	74	1E*CTD*	99	1GA*MFB*	79
1AA*FJC*	71	1AV*FRA*	75	1E*CTE*	100	1GA*MJ*	72
1AA*FR*	74	1AV*FRB*	76	1E*CTF*	99	1GA*MP*	66
1AA*FRA*	75	1AV*FRC*	77	1E*CTG*	100	1GA*MR*	77
1AA*FRB*	76	1AV*MB*	73	1E*DS*	102	1GA*PF*	67
1AA*FRC*	77	1AV*MJ*	72	1E*DSA*	102	1GA*PS*	67
1AA*FS*	73	1AV*MP*	66	1E*DSB*	102	1S*BF*	87
1AA*MB*	73	1B*BF*	87	1E*FH*	97	1S*BFA*	88
1AA*MF*	78	1B*BFA*	88	1E*FHA*	97	1S*BFB*	89
1AA*MFA*	79	1B*BFB*	89	1E*FHB*	97	1S*BP*	90
1AA*MFB*	79	1B*BT*	89	1E*FL*	98	1S*BT*	89
AA*MJ*	72	1B*DL*	90	1E*FLA*	98	1S*DK*	92
1AA*MP*	66	1B*DLB*	91	1E*FLB*	98	1S*DL*	90
1AA*MR*	77	1B*DS*	92	1EA*AP*	105	1S*DLA*	91
1AA*PF*	67	1B*DSA*	93	1EA*FJ*	104	1S*DLB*	91
1AA*PS*	67	1B*DSB*	93	1EA*FJA*	104	1S*DS*	92
1AP*FL*	80	1B*EK*	94	1EA*FJB*	104	1S*DSA*	93
1AP*FLA*	81	1B*FH*	85	1EA*FR*	103	1S*DSB*	93
1AP*FLB*	82	1B*FHA*	86	1EA*FRA*	103	1S*EK*	94
1AP*FLD*	83	1B*FHB*	87	1EA*FRB*	103	1S*FH*	85
1AP*FLE*	83	1B*FHD*	85	1EA*MP*	105	1S*FL*	80
1AP*JF*	94	1B*FHE*	86	1G*BF*	87	1S*FLA*	81
1AP*JM*	88	1B*FHF*	85	1G*BFA*	88	1S*FLB*	82
1AP*KF*	95	1B*FHG*	86	1G*BFB*	89	1S*FLD*	83
1AP*SL*	78	1B*FL*	80	1G*BP*	90	1S*FLE*	83
1AR*FJ*	68	1B*FLA*	81	1G*BT*	89	1S*FLG*	84
1AR*FJA*	69	1B*FLB*	82	1G*DK*	94	1S*JF*	94
1AR*FJB*	70	1B*FLD*	83	1G*DL*	90	1S*JM*	88
1AR*FJC*	71	1B*FLE*	83	1G*DLA*	91	1S*KF*	95
1AR*FR*	74	1B*FLF*	84	1G*DLB*	91	1S*KS*	96

SPECIALTY &
TRUCK HOSE

LOW & MEDIUM
PRESSURE HOSE

HIGH PRESSURE HOSE

HOSE FITTINGS

ADAPTERS &
TUBE FITTINGS

ACCESSORIES &
ASSEMBLY INSTRUCTIONS

HOSE ASSEMBLY
EQUIPMENT

APPENDICES

	PART NUMBER	PAGE	PART NUMBER	PAGE	PART NUMBER	PAGE	PART NUMBER	PAGE
SPECIALTY & TRUCK HOSE	1S*KSA*	96	07.078	163	2024	237	2229	224
	1S*KSB*	96	07.114	181	2025	239	2239	234
	1S*SL*	78	07.122	180	2027	247	2240	233
	1SA*FJ*	68	07.155	147	2028	240	2242	235
	1SA*FJA*	69	07.327	164	2029	242	2243	236
	1SA*FJB*	70	07.340	145	2030	241	2244	239
	1SA*FJC*	71	07.357	163	2031	242	2246	244
LOW & MEDIUM PRESSURE HOSE	1SA*FR*	74	07.390	180	2033	251	2247	227
	1SA*FRA*	75	07.420	162	2038	184	2249	239
	1SA*FRB*	76	07.421	145	2039	250	2250	238
	1SA*FRC*	76	07.721	164	2040	226	2251	229
	1SA*FS*	73	15.000	273	2041	248	2252	229
	1SA*MB*	73	15.063	273	2041-1	248	2253	231
	1SA*MF*	78	15.117	270	2042	249	2254	231
	1SA*MFA*	79	15.147	270	2042-1	249	2255	231
	1SA*MFB*	79	15.163	270	2043	250	2256	230
	1SA*MJ*	72	15.164	270	2043-1	250	2257	230
HIGH PRESSURE HOSE	1SA*MP*	66	15.165	270	2044	236	2266	255
	1SA*MR*	77	44-411	136	2045	226	2550	21
	1SA*PF*	67	44-412	136	2046	227	2554	21
	1SA*PS*	67	302A	26	2047	230	2556	34
	1Z*AP*	105	303	26	2048	229	2565	34
	1Z*BF*	101	401	137	2049	228	2570	21
	1Z*BFA*	101	403	142	2050	227	2575	32
	1Z*BFB*	101	406	137	2056	253	2580	37
	1Z*CT*	99	411	136	2056-1	253	2583	37
	1Z*CTA*	100	412	136	2060	255	2651	25
HOSE FITTINGS	1Z*CTB*	100	458	185	2061	255	2661	35
	1Z*CTD*	99	583	335	2061-1	255	2681	38
	1Z*CTE*	100	624	296	2062	256	2766	45
	1Z*CTF*	99	1206	65	2062-1	256	2781	47
	1Z*CTG*	100	1208	65	2063	274	2807	28
	1Z*DS*	102	1210	65	2066	245	2808	30
	1Z*DSA*	102	1212	65	2067	245	4007	65
	1Z*DSB*	102	1214	65	2067-1	245	4010	65
	1Z*FH*	97	1219	65	2068	246	4013	65
	1Z*FHA*	97	1290	267	2068-1	246	4401	137
ADAPTERS & TUBE FITTINGS	1Z*FHB*	97	1503	26	2070	249	4402	138
	1Z*MP*	105	1531	22	2071	250	4411	137
	1ZA*FJ*	104	1531A	22	2080	232	4412	136
	1ZA*FJA*	104	1561	335	2081	225	4414	138
	1ZA*FJB*	104	1562	335, 335	2082	225	4624	263
	1ZA*FL*	98	1563	335	2083	224	4720	159
	1ZA*FLA*	98	1582	335	2084	225	4721	156
	1ZA*FLB*	98	1597	335	2085	228	259-1290	281
	1ZA*FR*	103	1598	335	2087	230	259-2021	279
	1ZA*FRA*	103	1599	335	2088	228	259-2022	280
ACCESSORIES & ASSEMBLY INSTRUCTIONS	1ZA*FRB*	103	2000	243	2089	229	259-2023	279
	07.001	181	2001	243	2090	232	259-2024	280
	07.002	147	2002	244	2091	232	259-2027	280
	07.003	146	2003	244	2092	231	259-202702	281
	07.005	163	2004	268	2093	231	259-2039	280
	07.006	181	2007	243	2096	227	259-2062	281
	07.013	163	2015	224	2214	256	259-2071	280
	07.020	162	2018	234	2215	249	259-2081	277
	07.021	181	2020	253	2216	245	259-2082	277
	07.024	146	2021	233	2216-1	245	259-2083	277
HOSE ASSEMBLY EQUIPMENT	07.026	146	2022	235	2220	223	259-2085	277
	07.036	147	2023	236	2222	226	259-2087	278
APPENDICES								

PART NUMBER	PAGE	PART NUMBER	PAGE	PART NUMBER	PAGE	PART NUMBER	PAGE
259-2088	278	22546	195	190846	140	479501	182
259-2089	278	22617	195	190933	169	479601	183
259-2090	278	71416	264	190934	169	500023	261
259-2091	278	71418	263	190935	171	500024	261
259-2092	279	71422	264	190936	173	500025	259
259-2096	279	71423	263	190937	174	500454	251
259-2240	279	73014	265	190944	179	504089	262
259-4721	156	73056	246	190950	189	504095	251
259-900605	281	449-74446	191	63-190990	187	900564	348
4722	156	186100H	106	190992	169	900598	223
4725	157	186101	106	191000	138	900598-1	223
4738	176	186103	106	38-191074	188	900599	248
4739	177	186121	106	191395	141	900605	267
4740	177	190000	138	200001	268	900705	295
4741	177	190111	142	202003	242	900729	297
4742	177	190231	184	202006	242	900774	184
4743	177	190235	143	202113	234	900952	295
4744	159	190260	139	202114	234	CR170	28
4745	160	190261	139	202124	268	F2015	336
4750	178	190263	158	202208	322-323	FC136	52
4753	176	190264	158	202220	322	FC194	40
4767	160	190265	139	202232	265	FC195	49
4772	178	190276	142	202411	237	FC211	38
4775	140	190277	142	202413	238	FC212	44
4776	140	190287	158	202414	238	FC234	25
4777	141	190295	139	202702	254	FC252	20
4779	141	190296	139	202712	247	FC254	53
4790	161	190297	139	202713	255	FC273	54
4797	177	190299	139	202901	241	FC273B	54
7015X	288	190301	139	203002	252	FC300	27
7105X	287	190302	139	203002-1	252	FC310	41
7129X	288	190325	143	203003	257	FC321	27
7165X	287	190326	179	203003-1	257	FC323	50
7205X	289	190327	179	203005	256	FC324	50
7229X	288	190328	179	203005-1	256	FC325	51
7255X	289	190350	143	203006	240	FC332	33
7305X	288	190371	143	203007	239	FC350	23
7306X	288	190414	159	203008	252	FC352	20
7315X	290	190463	138	203101	252	FC355	23
7325X	289	190464	157	203102	252	FC363	31
7355X	290	190465	179	203103	240	FC364	31
7405X	291	190516	179	203104	241	FC425	296
7455X	291	63-190535	189	203301	240	FC465	29
7505X	290	63-190600	186	206209	255	FC466	35
7515X	291	190604	182	206209-1	255	FC469	30
7605X	293	190605	182	206801	246	FC498	36
7655X	293	190606	183	206801-1	246	FC510	41
7705X	292	190607	183	206804	246	FC563	32
7716X	292	190608	183	206804-1	246	FC579	57
7755X	292	190609	183	208006	232	FC598	36
7805X	292	63-190626	188	208007	232	FC606	56
7924X	287	38-190627	186	210212	253	FC606B	56
8112X	287	38-190628	189	210292	248	FC611	40
8165X	287	190672	177	210294	266	FC619	34
22008	323	190718	188	221501	249	FC629	21
22012	195	190742	188	222005	295	FC636	49
22033	195	190772	187	222022	295	FC639	42
22046	195	190773	187	222070	314, 317	FC645	66
22068	195	190800	182	479301	182	FC647	33

SPECIALTY & TRUCK HOSE

LOW & MEDIUM PRESSURE HOSE

HIGH PRESSURE HOSE

HOSE FITTINGS

ADAPTERS & TUBE FITTINGS

ACCESSORIES & ASSEMBLY INSTRUCTIONS

HOSE ASSEMBLY EQUIPMENT

APPENDICES

	PART NUMBER	PAGE	PART NUMBER	PAGE	PART NUMBER	PAGE	PART NUMBER	PAGE	
SPECIALTY & TRUCK HOSE	FC650	24	FC4562	118, 124	FC5582	121	FC7983	172	
	FC659	52	FC4564	119, 124	FC5612	120	FC7984	174	
	FC693	46	FC4571	118, 124	FC5847	178	FC7985	148	
	FC699	24	FC4582	121, 126	FC5848	178	FC7986	148	
	FC735	46	FC4612	120	FC5849	178	FC7987	148	
	FC736	53	FC4957	108	FC5852	179	FC7988	148	
	FC807	29	FC4960	110	FC5853	176	FC7989	148	
LOW & MEDIUM PRESSURE HOSE	FC854	53	FC4963	107	FC5954	147	FC7990	149	
	FC829	22	FC4965	107	FC5957	108	FC7991	149	
	FC839B	43	FC4967	107	FC5960	110	FC7992	149	
	FC849	43	FC4969	107	FC5963	107	FC8152	133	
	FC849B	44	FC5014	118	FC5965	107	FC8153	133	
	FC1105	264	FC5026	118	FC5967	107	FC8155	133	
	FC1132	264	FC5049	119	FC5969	107	FC8625	107	
HIGH PRESSURE HOSE	FC1229	209	FC5050	119	FC5973	171	FC8627	107	
	FC1347	64, 131, 132	FC5051	120	FC5974	172	FC8724	109	
	FC1349	131	FC5052	120	FC5975	172	FC8725	108	
	FC1373	131, 132	FC5053	122	FC5976	173	FC8726	110	
	FC1389	132	FC5054	121	FC5977	173	FC8727	111	
	FC1410	110-112	FC5060	173	FC5978	169	FC8779	129	
	FC1411	106	FC5075	149	FC5979	169	FC8802	110	
	FC1474	106	FC5098	130	FC5980	170	FC8853	108	
	FC1475	106	FC5130	151	FC5981	170	FC8854	109	
	FC1531	132	FC5131	151	FC5982	170	FC8855	109	
	FC1601	64, 128	FC5133	151	FC5983	170	FC8856	111	
	FC1851	208	FC5135	152	FC5984	170	FC8929	108	
	FC2119	192	FC5136	153	FC5985	165	FC9034	174	
HOSE FITTINGS	FC2325	209	FC5137	153	FC5986	165	FC9062	188	
	FC2326	212	FC5138	153	FC5987	165	FC9063	189	
	FC2383	65	FC5139	153	FC5988	165	FC9066	173	
	FC2540	64, 118-127	FC5140	153	FC5989	165	FC9118	174	
	FC2542	65	FC5141	153	FC5990	165	FC9152	133	
	FC2642	65	FC5142	152	FC5991	166	FC9153	133	
	FC2652	65	FC5143	152	FC5992	166	FC9155	133	
	FC2697	118, 119, 123	FC5144	151	FC5993	166	FC9171	187	
	FC2710	118, 123	FC5258	118	FC6216	130	FC9341	187	
	FC2713	192	FC5321	123	FC6217	130	FC9459	172	
	FC2717	64, 118-127	FC5322	123	FC6220	130	FC9515	106	
	FC2875	267	FC5323	123	FC6330	110	FC9516	106	
	FC3023	64, 133	FC5325	125	FC7031	142	FC9625	107	
ADAPTERS & TUBE FITTINGS	FC3425	191	FC5327	126	FC7216	130	FC9627	107	
	FC3443	64, 129-130	FC5329	126	FC7217	130	FC9631	106	
	FC3471	64, 110-112	FC5370	125	FC7220	130	FC9634	172	
	FC3596	64, 129-130	FC5371	126	FC7275	182	FC9712	106	
	FC3680	129	FC5372	125	FC7330	110	FC9724	109	
	FC4014	118, 123	FC5373	121	FC7370	171	FC9725	108	
	FC4049	119, 125, 126	FC5374	120	FC7371	172	FC9726	110	
	FC4050	119	FC5379	151	FC7372	173	FC9727	111	
	FC4051	120	FC5380	152	FC7373	173	FC9779	107	
	FC4052	120	FC5387	120	FC7374	174	FC9802	110	
	FC4053	122, 126	FC5432	164	FC7639	169	FC9846	129	
	FC4054	121	FC5503	124	FC7640	169	FC9853	108	
	FC4098	130	FC5504	121	FC7703	174	FC9854	109	
HOSE ASSEMBLY EQUIPMENT	FC4373	121, 126	FC5507	119	FC7713	171	FC9855	109	
	FC4374	120, 125	FC5513	121	FC7714	172	FC9856	111	
	FC4387	120, 125	FC5560	124	FC7715	173	FC9929	108	
	FC4504	121	FC5562	118	FC7740	169	FF593	191	
	FC4507	119	FC5564	119	FC7790	172	FF595	191	
	FC4513	121	FC5571	118	FC7811	174	FF687	191	
	APPENDICES								

PART NUMBER	PAGE	PART NUMBER	PAGE	PART NUMBER	PAGE	PART NUMBER	PAGE
FF688	191	FF2593	275	FJ3247	135	FJ8774	111
FF689	191	FF2742T	272	FJ3249	135	FJ8775	107
FF824	192	FF2743T	272	FJ3250	135	FJ8776	107
FF1010	223	FF2744T	272	FJ3254	134	FJ8777	107
FF1065	249	FF2745T	225	FJ3255	134	FJ8778	107
FF1066	249	FF2746T	273	FJ3468	134	FJ8779	107
FF1102	264	FF5162	262	FJ4649	185	FJ8780	107
FF1159	246	FF5163	250	FJ4650	185	FJ8896	112
FF1161	224	FF5164	251	FJ4709	185	FJ8897	112
FF1162	228	FF5238	261	FJ6188	112	FJ8898	112
FF1167	224	FF5239	260	FJ6260	128	FJ8899	112
FF1315	266	FF5321	262	FJ6274	128	FJ9023	126
FF1327	268	FF5539	260	FJ6277	128	FJ9024	170
FF1353	269	FF5540	262	FJ7023	180	FJ9025	170
FF1354	269	FF5541	260	FJ7041	132	FJ9026	170
FF1851T	210	FF5943T	257	FJ7044	179	FJ9027	171
FF1852T	213	FF5945T	258	FJ7188	112	FJ9028	171
FF1854T	212	FF5946T	258	FJ7199	150	FJ9029	118
FF1856T	211	FF6001T	257	FJ7200	168	FJ9030	118
FF1857T	221	FF6002T	257	FJ7201	155	FJ9031	119
FF1858T	211	FF6033T	257	FJ7202	155	FJ9033	174
FF1861T	215	FF6062T	258	FJ7203	155	FJ9035	124
FF1865T	216	FF6063T	258	FJ7204	155	FJ9036	124
FF1868T	214	FF6064T	258	FJ7227	150	FJ9037	124
FF1898T	220	FF6071T	259	FJ7260	128	FJ9038	124
FF1922T	210	FF6072	259	FJ7261	128	FJ9064	164
FF1980	269	FF6073T	259	FJ7274	128	FJ9065	164
FF1981	269	FF9016	192	FJ7277	128	FJ9066	164
FF1939	273	FF9075	227	FJ7344	167	FJ9068	176
FF1994T	219	FF9148	184	FJ7345	167	FJ9486	176
FF2000T	218	FF9173	266	FJ7346	167	FJ9567	106
FF2001T	217	FF9217	296	FJ7347	167	FJ9568	106
FF2030T	220	FF9446	191	FJ7358	180	FJ9569	108
FF2031T	216	FF9508	193	FJ8029	118	FJ9571	108
FF2032T	217	FF9509	193	FJ8030	118	FJ9573	109
FF2033T	221	FF9605	267	FJ8031	119	FJ9575	109
FF2035T	220	FF9672	193	FJ8307	112	FJ9579	110
FF2068T	215	FF9766	222	FJ8587	131	FJ9581	111
FF2093T	217	FF9767	222	FJ8608	122	FJ9587	131
FF2098T	219	FF9768	221	FJ8609	112	FJ9588	131
FF2114T	221	FF9807	195	FJ8611	122, 128	FJ9606	112
FF2115T	211	FF9855	195	FJ8612	112	FJ9608	122
FF2127T	215	FF9863	222	FJ8614	122, 128	FJ9609	112
FF2130T	212	FF10265	194	FJ8715	112	FJ9611	122
FF2133T	219	FF10266	194	FJ8717	122, 128	FJ9612	112
FF2137	223	FF10273	194	FJ8760	106	FJ9614	122
FF2138	223	FF90102	208	FJ8761	108	FJ9656	131, 132
FF2144T	219	FF90103	208	FJ8762	108	FJ9706	144
FF2151T	218	FF90152	184	FJ8763	108	FJ9707	144
FF2174T	220	FF90308	297	FJ8764	108	FJ9708	144
FF2209T	218	FF90311	297	FJ8765	109	FJ9709	144
FF2211T	212	FF90319	193	FJ8766	109	FJ9715	112
FF2227T	214	FF90396	273	FJ8767	109	FJ9717	122
FF2281T	218	FJ3094	134	FJ8768	109	FJ9718	127
FF2313T	218	FJ3114	134	FJ8769	110	FJ9719	127
FF2484T	273	FJ3152	135	FJ8770	110	FJ9720	127
FF2485T	272	FJ3243	135	FJ8771	110	FJ9721	127
FF2522T	259	FJ3244	135	FJ8772	110	FJ9724	149
FF2591	224	FJ3246	135	FJ8773	111	FJ9725	149

SPECIALTY & TRUCK HOSE
 LOW & MEDIUM PRESSURE HOSE
 HIGH PRESSURE HOSE
 HOSE FITTINGS
 ADAPTERS & TUBE FITTINGS
 ACCESSORIES & ASSEMBLY INSTRUCTIONS
 HOSE ASSEMBLY EQUIPMENT
 APPENDICES

	PART NUMBER	PAGE	PART NUMBER	PAGE	PART NUMBER	PAGE	PART NUMBER	PAGE
SPECIALTY & TRUCK HOSE	FJ9726	150	FJ9780	107	FT1058	342	GH506	55
	FJ9727	150	FJ9781	113	FT1081	336	GH506B	55
	FJ9728	154	FJ9782	113	FT1090	336	GH663	39
	FJ9729	154	FJ9783	115	FT1092	329	GH681	42
	FJ9730	154	FJ9784	115	FT1095	335	GH781	47
	FJ9731	154	FJ9785	115	FT1097	332	GH793	48
	FJ9732	161	FJ9786	115	FT1101	339	HP4	298
	FJ9733	161	FJ9787	115	FT1215	338	HP6	298
	FJ9734	162	FJ9788	115	FT1220	335	HP8	298
	FJ9735	162	FJ9789	116	FT1229	340	HPM	298
	FJ9740	175	FJ9790	116	FT1230	340	HSM	298
	FJ9741	175	FJ9791	116	FT1231	340	HLM	298
	FJ9742	175	FJ9792	116	FT1234	334	S1026	338
LOW & MEDIUM PRESSURE HOSE	FJ9743	175	FJ9793	116	FT1240	340	S1043	339
	FJ9744	175	FJ9794	116	FT1258	337	S1102	339
	FJ9745	175	FJ9795	116	FT1260	338	S1104	338
	FJ9746	175	FJ9796	116	FT1261	341	S1118	338
	FJ9747	175	FJ9797	114	FT1271	335	S1120	339
	FJ9759	106, 113	FJ9798	114	FT1279	340	SC1681	339
	FJ9760	106, 113	FJ9799	114	FT1281	333	SC1709	338
	FJ9761	108	FJ9800	114	FT1307	330-331	SC1772	338
	FJ9762	108	FJ9801	114	FT1312	341		
	FJ9763	108	FJ9802	114	FT1330-XL	329		
	FJ9764	108	FJ9896	112	FT1355	296		
	FJ9765	109	FJ9897	112	FT1380	327		
	FJ9766	109	FJ9898	112	FT1380P	327		
HIGH PRESSURE HOSE	FJ9767	109	FJ9899	112	FT1390	329		
	FJ9768	109	FJ9900	117	FT1500	337		
	FJ9769	110	FJ9901	117	FT2015	339		
	FJ9770	110	FJ9902	117	GG106-NP	274		
	FJ9771	110	FJ9903	117	GG108-NP	271		
	FJ9772	110	FJ9915	106	GG110-NP	275		
	FJ9773	111	FJ9916	106	GG308-NP	271		
	FJ9774	111	FJ9917	113	GG310-NP	275		
	FJ9775	107	FT1013	333	GH120	45		
	FJ9776	107	FT1023	334	GH194	39		
	FJ9777	107	FT1028	334-335	GH195	48		
	FJ9778	107	FT1033	334	GH466	55		
	FJ9779	107	FT1038A	336	GH493	51		
HOSE FITTINGS								
ADAPTERS & TUBE FITTINGS								
ACCESSORIES & ASSEMBLY INSTRUCTIONS								
HOSE ASSEMBLY EQUIPMENT								
APPENDICES								

Terms

	PAGE		PAGE		PAGE		PAGE
AAMVA	346	Fluid Compatibility Charts	349-355	O-Ring Kits	194	Socket Data	64-65
ABS	346	Gladhand	184	Pressure Drop Chart Hose	357	SOCKETLESS BSP/Metric	180
Adapters	196	Global BSP Fittings	87	PTFE	18	SOCKETLESS Hose	32
Agencies (Government & Industrial)	346	Global Crimp Fitting Data	66	Railroad Airbrake Hose	22	SOCKETLESS SAE	177
Airbrake Hoses	21-23	Global Crimp Socket Data	63	Reusable Railroad Airbrake	185	Spiral Single Skive Crimp	106
Air Compressor Discharge Hose	28-30	Global Metric Fittings	90	Reusable 100R2 BSP Skive	162	Split Flange Kits	191
AQP®	13-14	Global Nipple Crimp/Clamp	66	Reusable 100R2 Skive Metric	163	Spring Guard	184
BRUISER™	iii	Global OTC Crimp	66	Reusable 100R2 Skive SAE	156	Staplok®	78
CGA	28	Global Skive Crimp	66	Reusable 100R2 TTC	165	Super Gem	186
Connectors	196	Global Skive Socket	66	Reusable 100R5	136	UL	346
Constant Pressure Hose	42-44	Global Spiral TTC Crimp	97	Reusable 100R5 BSP	145	USCG/MMT	346
Convolute PTFE Hose	31-32	Global TTC Crimp	66	Reusable 100R5 Metric	146	Waterblast Hose	53
Crimp Fitting Numbering System	62-63	Global TTC12 Crimp	66	Reusable Fittings	136		
Crimp Socket Data	64	HI-IMPULSE®	38-40, 47-49	Reusable HI-PAC	151		
DIN	346	HI-PAC®	41	Reusable Komatsu	164		
DNV	346	Internal Skive Crimp	118	Reusable Lifesaver	138, 148, 152, 157, 166		
DOT	346	Jack Hose (10,000 psi)	57	Reusable Power Steering/ Airbrake	182		
EN/CEN	346	LPG	27, 28	Reusable Sockets	65		
EPDM/EPR	40, 49	MatchMate BLUE®	39, 48	Reusable Spiral Skive	169		
FDA	346	MatchMate ICE®	45	Reusable TTC 100R1	148		
Fittings	58	MatchMate PLUS®	39, 47-48, 51	SAE 100R Hose	20		
Flat Crimp/PTFE	129	Mil/DOD	346	Seal Materials	192		
		MSHA	346				
		O-Ring	192				

SPECIALTY &
TRUCK HOSE

LOW & MEDIUM
PRESSURE HOSE

HIGH PRESSURE HOSE

HOSE FITTINGS

ADAPTERS &
TUBE FITTINGS

ACCESSORIES &
ASSEMBLY INSTRUCTIONS

HOSE ASSEMBLY
EQUIPMENT

APPENDICES

Hose Application Reference Symbols

Industry symbols are provided for each hose indicating where it is typically used. But remember, a hose can be used in any industry, provided it meets the estab-

lished application requirements. This list is provided as a guide. Final selection is further dependent on pressure, fluid, fluid concentrations, temperature and inter-

mittent or continuous exposures and government or industry specifications.

SPECIALTY & TRUCK HOSE
LOW & MEDIUM PRESSURE HOSE
HIGH PRESSURE HOSE
HOSE FITTINGS
ADAPTERS & TUBE FITTINGS
ACCESSORIES & ASSEMBLY INSTRUCTIONS
HOSE ASSEMBLY EQUIPMENT
APPENDICIES



AIR CONDITIONING
Refer To A/C & R Catalog
A-HOAC-MC001-E



GROUND SUPPORT EQUIPMENT
FC611 FC693
FC636



AIR (HIGH PRESSURE)
1503 FC300



CHEMICAL TRANSFER
2661 FC364
FC563 FC619



HIGH PERFORMANCE
Refer To Performance Catalog
A-SPPE-MC001-E



JACK HOSE
(10,000 PSI Max. for all Hoses)
FC579



LOW TEMPERATURE (-70°)
GH120



LPG
CR170 FC321



MARINE (FUEL & OIL)
2807 FC234
FC363 FC364
FC563



RAILROAD AIR BRAKE
1531 1531A

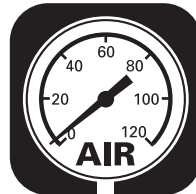

SHOP AIR
2556 2565
FC332 FC647



UTILITY
Refer to Everflex Catalog
E-HOEV-MC001-E



WATERBLAST
(10,000 PSI Max. for all Hoses)
FC254-08 FC854-08



TRUCK

	Heater	Engine Fuel/Oil	Airbrake	Compressor	Pwr Steering
	FC252	1503 2807	1503 2550	2807 FC363	FC300 FC310
	Coolant	FC300 FC350	2570 FC300	FC699*	FC510
	FC352	FC355 FC699	FC350 FC355	* In conjunction with tubing	
		FC650	FC629	FC829	

Hose Index

Alphabetical Index

DESCRIPTION	PAGES
A/C and Refrigeration Hose	17
AQP Hose	13-14
Hose	20-57
Hydraulic	34-57
AQP	35, 36, 39, 40, 41, 45, 48, 49, 50, 51
AQP/Hi-IMPULSE	39, 40, 48, 49
AQP/Hi-Pac	41
Double wire braid	42-49
Four spiral wire	49-53

DESCRIPTION	PAGES
Four or six spiral wire	54-56
HI-IMPULSE	38-40, 47-49
Hi-Pac	41
MatchMate BLUE	39, 48
MatchMate ICE	45
MatchMate Plus	39, 47, 48, 51
Single wire braid	38-42
Textile braid	21, 22, 32-37
Wire inserted suction	34, 35

DESCRIPTION	PAGES
Special application	20-34
Airbrake	21-23
AQP	23-25, 27, 33
Convuluted PTFE	31, 32
Engine and airbrake	23
EPDM	40, 49
Fuel and oil	23-27
Jack Hose	57
LPG	27, 28

DESCRIPTION	PAGES
Power steering	41
Railroad airbrake	22
Silicone rubber (coolant)	20
Silicone rubber (heater)	20
SOCKETLESS	32-34
PTFE	28-32
Textile braid low pressure	32-34, 35-37
How to order	12
PTFE Hose	18-19
Thermoplastic Hose	15-16

Part Number Index

PART #	PG.	PART #	PG.
302A	26	2575	32
303	26	2580	37
1503	26	2583	37
1531	22	2651	25
1531A	22	2661	35
2550	21	2681	38
2554	21	2766	45
2556	34	2781	47
2565	34	2807	28
2570	21	2808	30

PART #	PG.	PART #	PG.
CR170	28	FC273B	54
FC136	52	FC300	27
FC194	40	FC310	41
FC195	49	FC321	27
FC211	38	FC323	50
FC212	44	FC324	50
FC234	25	FC325	51
FC252	20	FC332	33
FC254	53	FC350	23
FC273	54	FC352	20

PART #	PG.	PART #	PG.
FC355	23	FC598	36
FC363	31	FC606	56
FC364	31	FC606B	56
FC465	29	FC611	40
FC466	35	FC619	34
FC469	30	FC629	21
FC498	36	FC636	49
FC510	41	FC639	42
FC563	32	FC647	33
FC579	57	FC650	24

PART #	PG.	PART #	PG.
FC659	52	GH120	45
FC693	46	GH194	39
FC699	24	GH195	48
FC735	46	GH466	55
FC736	53	GH493	51
FC807	29	GH506	55
FC829	22	GH663	39
FC839B	43	GH681	42
FC849	43	GH781	47
FC849B	44	GH793	48

Eaton's Aeroquip Hose and Fitting Assembly Product Warning

Flexible hose lines offer many advantages over rigid tubing including routing ease, vibration absorption, sound deafening and the ability to accommodate movement of connected components. However, hose lines require caution in use not only to provide long service, but also to guard against potentially dangerous failure.

Important

The user should carefully observe the precautions listed in this catalog, including the recommendations on the selection of hose and fittings on the relevant pages, and the pages on fluid compatibility. In addition, care should be taken not to exceed the minimum bend radius listed for each hose size and type in the hose section.

Maximum operating pressure should not exceed pressures listed in the hose data. Instructions for assembling fittings to different hose should be followed carefully to ensure the performance of the completed assembly.

WARNING Eaton fitting tolerances are engineered to match Eaton's Aeroquip hose tolerances. The use of Eaton fittings on hose supplied by other manufacturers and/or the use of Eaton's Aeroquip hose with fittings supplied by other manufactures may result in the production of unreliable and unsafe hose assemblies and is neither recommended nor authorized by Eaton Corporation or any of its affiliates or subsidiaries.

WARNING Application considerations must be observed in selecting appropriate components for the application of these products contained herein. The failure to follow the recommendations set forth in this catalog may result in an unstable application which may result in serious personal injury or property damage.

EATON CORPORATION OR ANY OF ITS AFFILIATES OR SUBSIDIARIES SHALL NOT BE SUBJECT TO AND DISCLAIMS ANY OBLIGATIONS OR LIABILITIES (INCLUDING BUT NOT LIMITED TO ALL CONSEQUENTIAL, INCIDENTAL AND CONTINGENT DAMAGES) ARISING FROM TORT CLAIMS (INCLUDING WITHOUT LIMITATION NEGLIGENCE AND STRICT LIABILITY) OR OTHER THEORIES OF LAW WITH RESPECT TO ANY HOSE ASSEMBLIES NOT PRO-

DUCTED FROM GENUINE AEROQUIP HOSE FITTINGS, HOSE AND AEROQUIP APPROVED EQUIPMENT, AND IN CONFORMANCE WITH EATON'S AEROQUIP PROCESS AND PRODUCT INSTRUCTIONS FOR EACH SPECIFIC HOSE ASSEMBLY.

Failure to follow these processes and product instructions and limitations could lead to premature hose assembly failures resulting in property damage, serious injury or death.

Routing

If the user follows the recommendations on hose line routing and installation as provide herein, improved safety and longer service life of any hose installation will result.

How to Order



Accurate processing and prompt delivery of your order depends on easy identification of your requirements. Please order Aeroquip brand parts using correct part numbers as described in this catalog. Inquiries and orders should be directed to your Aeroquip Distributor or:

Eaton Corporation
 14615 Lone Oak Road
 Eden Prairie, MN 55344
 USA
 952/937-9800;
 Fax: 952/974-7722
 www.hydraulics.eaton.com

Part numbers and dash sizes

Dash size designates the nominal size in 16ths of an inch. This number immediately follows the part number and is separated from it with a dash.

Dimensions

Dimensions given in this catalog for Aeroquip products are approximate and should be used for reference only. Exact dimensional information for a given product is subject to change and varying tolerances; contact Eaton directly for full current information.

! WARNING Hose assemblies

Eaton manufactures the terminal ends of our hose fittings to the appropriate requirements established by the SAE. Therefore, the performance ratings of these hose fittings meet the SAE requirements. It is possible to order a hose assembly with a fitting terminal end that has a performance rating lower than the hose rating. When ordering hose assemblies, please keep the connecting end performance rating in mind since this may affect overall hose assembly performance.

Hose assembly components (hose and fittings) are easily assembled in the field. However, factory assembled reusable and crimped hose assemblies are available.

For complete information, contact Eaton.

Cut length hose

Cut lengths of hose should be ordered as shown below by specifying lengths in inches.

For numeric part numbers: 2651-10-00484
 Hose type _____
 Hose size (in 16ths of an inch) _____
 Cut length (in inches) _____
 last digit is in 1/8ths of an inch 00484 = 48 1/2 inches

For alpha-numeric part numbers: FC300-08-00484
 Hose type _____
 Hose dash size _____
 Cut length (in inches) _____
 last digit is in 1/8ths of an inch 00484 = 48 1/2 inches

Bulk hose

Bulk hose should be ordered by specifying length in feet as shown below.

Complete number 500 ft.-2651-10
 Quantity (in feet) _____
 Hose type _____
 Hose size (in 16ths of an inch) _____

Note: Length tolerance for hose, assemblies and sleeves is:

- Up to and including 12 inches: $\pm 1/8"$
- Above 12 inches to and including 18 inches: $\pm 3/16"$
- Above 18 inches to and including 36 inches: $\pm 1/4"$
- Above 36 inches: $\pm 1%$ of length

AQP Hose

Refer to AQP Catalog A-HOAQ-MC001-E for more information on AQP hose.

FC300 AQP Hose



Exceeds SAE100R5

The superior high-temperature, abrasion-resistant hose. Features extensive fluid compatibility.

See page 27.

FC194 AQP/Hi-IMPULSE Hose



Exceeds SAE100R1A, EN853 1ST, ISO1436-1 TYPE 1ST

Combines superior high-temperature resistance and extensive fluid compatibility plus operating pressures up to 40% greater than SAE100R1 hose.

Aeroquip brand HI-IMPULSE hose construction is a patented process. Patent number 3,725,167.

See page 40.

FC195 AQP/Hi-IMPULSE Hose



Exceeds SAE100R2A, EN853 2ST, ISO1436-1 TYPE 2ST

Combines superior high temperature resistance and extensive fluid compatibility plus operating pressures up to 40% greater than SAE100R2 hose.

Aeroquip brand HI-IMPULSE hose construction is a patented process. Patent number 3,725,167.

See page 49.

FC510 AQP/Hi-Pac Hose



Exceeds SAE100R2 Performance Requirements

Combines the flexibility and economy of Hi-Pac hose with the temperature and fluid compatibility of AQP hose.

Aeroquip brand Hi-Pac hose construction is patented. Patent number 3,463,197.

See page 41.

FC323 AQP Hose



Uniform Pressure Spiral Wire Hose 210,0 BAR [3000 psi]

The features of AQP construction and spiral wire reinforcement are combined in this quality hose style.

See page 50.

FC324 AQP Hose



Uniform Pressure Spiral Wire Hose 280,0 BAR [4000 psi]

Features the patented AQP tube compound and 4-spiral wire reinforcement. Uses the same fittings as FC323.

See page 50.

FC325 AQP Hose



Uniform Pressure Spiral Wire Hose 350,0 BAR [5000 psi]

Features the patented AQP tube compound and 4-spiral wire reinforcement. Pressures to 350,0 BAR [5000 psi].

See page 51.

SPECIALTY & TRUCK HOSE

LOW & MEDIUM PRESSURE HOSE

HIGH PRESSURE HOSE

HOSE FITTINGS

ADAPTERS & TUBE FITTINGS

ACCESSORIES & ASSEMBLY INSTRUCTIONS

HOSE ASSEMBLY EQUIPMENT

APPENDICES

FC350 AQP Hose

Exceeds FMVSS-106 Type All

The revolutionary truck hose with superior abrasion resistance. Features an AQP tube for excellent fluid compatibility and temperature requirements.

See page 23.

FC355 AQP Hose

Exceeds FMVSS-106 Type All

Ideal for truck maintenance and piping conditions where fluid compatibility and chemical resistance are required.

Has a blue AQP elastomer cover for fluid resistance.

See page 23.

FC234 AQP Hose

Fire resistant fuel hose meets USCG AI requirements. Offers positive fire resistance in

critical applications without using a firesleeve.

See page 25.

FC332 AQP SOCKETLESS Hose

Offers extended fluid compatibility and operating temperature range for low pressure applications.

Used with Aeroquip brand SOCKETLESS fittings for quick and easy assembly.

See page 33.

FC498 AQP Hose

Exceeds SAE100R6

For low pressure applications.

See page 36.

2661 AQP Hose

Exceeds SAE100R4

The dual-purpose hose with extensive fluid compatibility is ideal for either suction or chemical transfer applications.

See page 35.

GH194 MatchMate BLUE AQP/HI-IMPULSE Hose

Exceeds SAE 100R1AT

A thin cover, 1-wire version of AQP/HI-IMPULSE hose that allows the use of Aeroquip MatchMate Plus Thru-The-Cover (TTC) fittings.

Pressures to 227,0 BAR [3250 psi].

See page 39.

GH195 MatchMate BLUE AQP/HI-IMPULSE Hose

Exceeds SAE 100R2AT

A thin cover, 2-wire version of AQP/HI-IMPULSE hose that allows the use of Aeroquip MatchMate Plus Thru-The-Cover (TTC) fittings.

Pressures to 397,0 BAR [5750 psi].

See page 48.

FC650 AQP Hose

High Temperature Fuel and Oil

The revolutionary truck hose with superior abrasion resistance. Features an AQP tube for excellent fluid compatibility and temperature requirements.

Pressure to 70,0 BAR [1000 psi].

See page 24.

Thermoplastic Hose

Refer to Everflex Catalog E-HOEV-MC001-E for more information on Thermoplastic hose.

FC372 Polyon™ Thermoplastic Hose

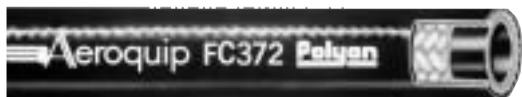

SAE100R7 - Medium Pressure

Premium hose with elastomer tube (Hytrel*), single braid polyester reinforcement, black polyurethane cover, and operating tem-

perature range of -54°C to +93°C [-65°F to 200°F].
For more information, refer to catalog E-HOEV-MC001-E.

FC373 Polyon Thermoplastic Hose



SAE100R7 - Medium Pressure - Non-Conductive

Premium hose with elastomer tube (Hytrel*), single braid polyester reinforcement, orange polyurethane cover and operating

temperature range of -54°C to +93°C [-65°F to 200°F].
For more information, refer to catalog E-HOEV-MC001-E.

FC374 Polyon Thermoplastic Hose

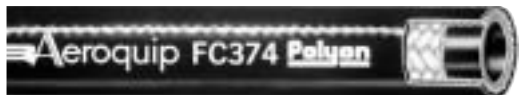

SAE100R8 - High Pressure

Premium hose with elastomer tube (Hytrel*), single braid aramid polyester reinforcement, black polyurethane cover and operating temperature

range of -54°C to +93°C [-65°F to 200°F].
For more information, refer to catalog E-HOEV-MC001-E.

FC375 Polyon Thermoplastic Hose



SAE100R8 - High Pressure - Non-Conductive

Premium hose with elastomer tube (Hytrel*), single braid aramid polyester reinforcement, orange polyurethane cover and operating temperature

range of -54°C to +93°C [-65°F to 200°F].
For more information, refer to catalog E-HOEV-MC001-E.

FC376 Polyon Thermoplastic Hose



Very high Pressure

Premium hose with elastomer tube (Hytrel*), single braid aramid polyester reinforcement, black polyurethane cover and operating temperature

range of -40°C to +66°C [-40°F to 150°F].
For more information, refer to catalog E-HOEV-MC001-E.

FC377 Polyon Thermoplastic Hose



Very high Pressure - Non-Conductive

Premium hose with elastomer tube (Hytrel*), single braid aramid polyester reinforcement, orange polyurethane cover and operating temperature

range of -40°C to +66°C [-40°F to 150°F].
For more information, refer to catalog E-HOEV-MC001-E.

FC390 Polyon Thermoplastic Hose



SAE100R7 - Medium Pressure with Flame Retardant Cover

Premium hose with elastomer tube (Hytrel*), double braid polyester reinforcement, black perforated flame retardant polyurethane cover and

operating temperature range of -54°C to +93°C [-65°F to 200°F].
For more information, refer to catalog E-HOEV-MC001-E.

*Hytrel is a registered trademark of E.I. DuPont.

FC690 Polyon Thermoplastic Hose



SAE100R7 - Medium Pressure - Low Temperature Flexing

Premium hose with elastomer tube (Hytrel*), double braid aramid reinforcement, black perforated polyurethane cover with operating temperature

range of -54°C to +93°C [-65°F to 200°F], and maximum flex life. For more information, refer to catalog E-HOEV-MC001-E.

FC701 Gator™ Hose

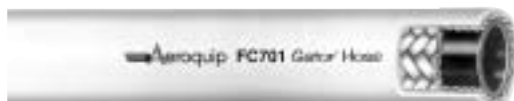

2,500 PSI Sewer Cleaning Hose

Blue polyethylene tube, single polyester braid reinforcement and orange ether-based polyurethane cover hose and maximum flexibility. Operating

temperature range of -40°C to +66°C [-40°F to +150°F]. For more information, refer to catalog E-HOEV-MC001-E.

FC702 Gator Hose



3,000 PSI Sewer Cleaning Hose

Blue polyethylene tube, single polyester braid reinforcement and blue ether-based polyurethane cover hose and maximum flexibility. Operating

temperature range of -40°C to +66°C [-40°F to +150°F]. For more information, refer to catalog E-HOEV-MC001-E.

FC727 Polyon Thermoplastic Hose



SAE100R7 - Medium Pressure

High quality thermoplastic hose with nylon tube, two polyester braid reinforcement, polyurethane cover, and operating temperature range of -40°C to +93°C [-40°F to 200°F].

For more information, refer to catalog A-HH-MB-0001-E.

FC901 Polyon Thermoplastic Twin-Line Hose



SAE100R7 - Medium Pressure - Non-Conductive

Two FC373 hoses welded together. Hose constructed of elastomer tube (Hytrel*), single braid polyester reinforcement, with orange polyurethane cover and operating temperature

range of -54°C to +93°C [-65°F to 200°F]. For more information, refer to catalog E-HOEV-MC001-E.

FC902 Polyon Thermoplastic Twin-Line Hose



SAE100R7 - Medium Pressure

Two FC372 hoses welded together. Hose constructed of elastomer tube (Hytrel*), single braid polyester reinforcement, with black polyurethane cover

and operating temperature range of -54°C to +93°C [-65°F to 200°F]. For more information, refer to catalog E-HOEV-MC001-E.

FC914 Polyon Thermoplastic Twin-Line Hose



SAE100R8 - High Pressure

Two FC374 hoses welded together. Hose constructed of elastomer tube (Hytrel*), single braid polyester reinforcement, with black polyurethane cover

and operating temperature range of -54°C to +93°C [-65°F to 200°F]. For more information, refer to catalog E-HOEV-MC001-E.

FC916 Thermoplastic Twin-Line Hose



SAE100R8 - High Pressure - Non-Conductive

Two FC375 hoses welded together. Hose constructed of elastomer tube (Hytrel*), single braid polyester reinforcement, with orange polyurethane cover and operating temperature

range of -54°C to +93°C [-65°F to 200°F]. For more information, refer to catalog E-HOEV-MC001-E.

*Hytrel is a registered trademark of E.I. DuPont.

A/C and Refrigeration Hose

Refer to A/C and Refrigeration Catalog A-HOAC-MC001-E for more information on A/C and Refrigeration hose.

GH134 Multi-Refrigerant A/C and Refrigeration Hose



Exceeds SAE-J2064, Type E.

Hose constructed of polyimide veneer tube, with polyester reinforcement and chlorobutyl cover. Temperature range is -40°C to +135°C [-40°F to +275°F]. Fitting selection includes factory crimp and the E-Z Clip line of A/C connections.

For more information, refer to catalog A-HOAC-MC001-E.

FC558 R134a A/C and Refrigeration Hose



Meets SAE J2064 with 100R5 reusable fittings, sizes 10 to 24.

Butyl tube and polyester braid, abrasion-resistant cover. Designed to work with 100R5 reusable fittings. Temperature range is 40°C to +121°C [-40°F to +250°F].

For more information, refer to catalog A-HOAC-MC001-E.

FC802 Multi-Refrigerant A/C and Refrigeration Hose



Hose constructed of polyimide veneer tube, with synthetic rubber cover. Designed to work with 100R5 reusable fittings. Temperature range is -40°C to +121°C [-40°F to +250°F].

For more information, refer to catalog A-HOAC-MC001-E.

FC555 Multi-Refrigerant A/C and Refrigeration Hose



Meets SAE-J2064.

Flexible hose is constructed of a corrugated polyimide tube for exceptional flexibility in large bus applications. This is a factory crimp product. Please contact Eaton for additional information to qualify for field crimp of the

FC555 hose. Temperature range is -40°C to +125°C [-40°F to +257°F].

For more information, refer to catalog A-HOAC-MR001-E.

FC505 Low Effusion, Multi-Refrigerant A/C and Refrigeration Hose



Hose constructed of polyimide veneer tube with polyester reinforcement and synthetic rubber cover. The FC505 fitting program is factory crimp only.

Temperature range is -40°C to +135°C [-40°F to +275°F].

For more information, refer to catalog A-HOAC-MC001-E.

PTFE Hose

Refer to Everflex Catalog E-HOEV-MC001-E for more information on PTFE hose.

Smooth Bore "S" Series Hose



Everflex S Series tube is reinforced with 304 stainless steel wire. All sizes have a minimum of .040" thick extruded virgin PTFE. That is 33% more PTFE than most other manufacturers offer. The additional

PTFE results in improved bend radius, kink resistance and slows permeation of gases. Temperature range is -54°C to +230°C [-65°F to +450°F].

For more information, refer to catalog E-HOEV-MC001-E.

Smooth Bore "B" Series Hose



Everflex B Series is reinforced with bronze wire. All sizes have a minimum of 0.040" thick extended virgin PTFE. Everflex B Series hose has traditionally been used in high vibration envi-

ronments. Temperature range is -54°C to +204°C [-65°F to +400°F].

For more information, refer to catalog E-HOEV-MC001-E.

Smooth Bore "STW" Series Hose



Everflex STW Series tube is reinforced with 304 stainless steel wire. STW hose is available as an alternative where competitors' thin wall products are specified and S Series hose can not be substituted. Radius in inches to inside bend.

Multiply bend radius by 1.25 for dynamic applications. Temperature range is -54°C to +230°C [-65°F to +450°F].

For more information, refer to catalog E-HOEV-MC001-E.

Smooth Bore "S-3" Series Hose



S-3 with a PVC cover is a PTFE hose which can be used for DOT 571.106 hydraulic brake line applications. PVC cover is on the exterior in 0.020" thickness. The PVC cover is useful to protect motorcycle paint

jobs or provide durability in an abrasive environment. Temperature range is -40°C to +93°C [-40°F to +200°F].

For more information, refer to catalog E-HOEV-MC001-E.

Smooth Bore "SC" Series Hose



SC Series hose is identical to the S series with one exception. SC hose has an internal conductive static dissipating liner that provides a path to the hose end fittings for applications where flow induced electrostatic charges can occur.

Radius in inches to inside bend. Multiply bend radius by 1.25 for dynamic applications. Temperature range is -54°C to +230°C [-65°F to +450°F].

For more information, refer to catalog E-HOEV-MC001-E.

Smooth Bore "SCTW" Series Hose



SCTW Series hose is identical to the STW Series with one exception. SCTW hose has an internal conductive static dissipating liner that provides a path to the hose end fittings for applications where flow induced electro-

static charges can occur. Radius in inches to inside bend. Multiply bend radius by 1.25 for dynamic applications. Temperature range is -54°C to +204°C [-65°F to +400°F]. For more information, refer to catalog E-HOEV-MC001-E.

H243 PTFE Hose



Inner Tube: PTFE, braid: single stainless steel braid, 1" size double stainless steel braid (type 304). Temperature range is -54°C to +230°C [-65°F to +450°F].

Note: Not for use in applications requiring static dissipation.

For more information, refer to catalog E-HOEV-MC001-E.

H277 Conductive PTFE Hose



Inner Tube: PTFE, braid: single stainless steel braid, 1" size double stainless steel braid (type 304). Temperature range is -54°C to +230°C [-65°F to +450°F].

Note: Not for use in applications requiring static dissipation.

For more information, refer to catalog E-HOEV-MC001-E.

Smooth Bore "Hi-PSI" Series Hose



Hi-PSI Series hose is a heavy wall PTFE hose for very high pressure applications. The reinforcement is braided and not spiraled allowing for better hose flexibility.

Temperature range is -54°C to +204°C [-65°F to +400°F].

For more information, refer to catalog E-HOEV-MC001-E.

Conductive & Non-Conductive Convuluted Hose Conv-O-Crimp



Convuluted PTFE tube with 304 stainless steel wire braid reinforcement.

Industrial applications include: automotive, platten presses, pharmaceutical, truck and bus, reverse osmosis, hydraulics, chemical processing, steam, air,

water, tire manufacturing, electronics, steel mills, food processing, and tank truck transfer. Temperature range is -54°C to +204°C [-65°F to +400°F].

For more information, refer to catalog E-HOEV-MC001-E.

FC252 Silicone rubber (heater)



# Part Number	Hose I.D.		Hose O.D.		Maximum Operating Pressure		Minimum Burst Pressure		Minimum Bend Radius		Weight of Hose	
	mm	in	mm	in	bar	psi	bar	psi	mm	in	Kg/m	lbs/ft
FC252-06	9,7	0.38	18,3	0.72	3,5	50	14,0	200	38,1	1.50	0,22	0.15
FC252-08	12,7	0.50	20,6	0.81	3,5	50	14,0	200	50,8	2.00	0,27	0.18
FC252-10	16,0	0.63	23,9	0.94	2,8	40	11,0	160	63,5	2.50	0,28	0.19
FC252-12	19,1	0.75	26,9	1.06	2,8	40	11,0	160	76,2	3.00	0,41	0.28
FC252-16	25,4	1.00	34,0	1.34	2,5	35	10,0	140	101,6	4.00	0,53	0.36

Construction

Silicone rubber tube, braided fiber reinforcement and silicone rubber cover.

Operating Temperature Range

-54°C to +177°C [-65°F to +350°F]

Application

Heater hose for passenger cars and trucks; connecting lines from hot water heaters to coolant-circulating systems. For more information on specific fluid applications and high temperature ratings, see pages 349-355.

For Complete Agency Listings

See pages 346-348.

Fitting Reference Page

Reusable	
Clamp	184

FC352 Silicone rubber (coolant)



# Part Number	Hose I.D.		Hose O.D.		Maximum Operating Pressure		Minimum Burst Pressure		Weight of Hose	
	mm	in	mm	in	bar	psi	bar	psi	Kg/m	lbs/ft
FC352-08	12,7	0.50	23,9	0.94	7,0	100	30,0	425	0,25	0.17
FC352-10	16,0	0.63	26,9	1.06	7,0	100	30,0	425	0,32	0.22
FC352-12	19,1	0.75	30,2	1.19	7,0	100	30,0	425	0,40	0.27
FC352-14	22,4	0.88	33,5	1.32	7,0	100	30,0	425	0,46	0.31
FC352-16	25,4	1.00	36,6	1.44	6,0	90	26,0	375	0,50	0.34
FC352-18	28,4	1.12	39,6	1.56	6,0	90	26,0	375	0,61	0.41
FC352-20	31,8	1.25	42,9	1.69	5,9	85	24,0	350	0,66	0.45
FC352-22	35,1	1.38	46,2	1.82	5,9	85	24,0	350	0,74	0.50
FC352-24	38,1	1.50	49,3	1.94	5,9	85	24,0	350	0,81	0.55
FC352-26	41,4	1.63	52,3	2.06	5,6	80	22,0	325	0,86	0.58
FC352-28	44,5	1.75	55,6	2.19	5,6	80	22,0	325	0,93	0.63
FC352-32	50,8	2.00	62,0	2.44	5,2	75	21,0	300	1,06	0.72
FC352-36	57,2	2.25	68,3	2.69	5,2	75	21,0	300	1,20	0.81
FC352-38	60,1	2.38	71,6	2.82	4,2	60	17,0	250	1,24	0.84
FC352-40	63,5	2.50	74,7	2.94	4,2	60	17,0	250	1,31	0.89
FC352-44	69,9	2.75	81,0	3.19	3,5	50	14,0	200	1,45	0.98
FC352-48	76,2	3.00	87,4	3.44	3,5	50	14,0	200	1,56	1.06
FC352-56	88,9	3.50	100,1	3.94	2,8	40	12,0	175	1,85	1.25
FC352-64	101,6	4.00	112,8	4.44	2,5	35	10,5	150	2,13	1.44
FC352-96	152,4	6.00	164,3	6.47	2,0	25	7,0	100	3,45	2.34
FC352-112	177,8	7.00	189,7	7.47	1,0	19	6,0	75	4,03	2.73

Construction

Silicone rubber tube, four spirals of nylon and silicone rubber cover.

Operating Temperature Range

-54°C to +177°C [-65°F to +350°F]

Application

Coolant system service with liquid-cooled engines. For more information on specific fluid applications and high temperature ratings, see pages 349-355.

For Complete Agency Listings

See pages 346-348.

Fitting Reference Page

Reusable	
Clamp	184

2550/2554

Airbrake

SAE J1402 FMVSS106

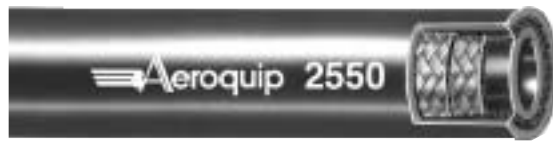

# Part Number	Hose I.D.		Hose O.D.		Maximum Operating Pressure		Minimum Burst Pressure		Minimum Bend Radius		Weight of Hose	
	mm	in.	mm	in.	bar	psi	bar	psi	mm	in.	Kg/m	lbs/ft
2550-6	9,7	0.38	19,1	0.75	16,0	225	62,0	900	44,5	1.75	0,30	0.20
2554-6	9,7	0.38	19,1	0.75	16,0	225	62,0	900	95,3	3.75	0,27	0.18

Construction

Synthetic rubber tube, double textile braids and synthetic rubber cover.

Operating Temperature Range

2550: -40°C to +93°C
[-40°F to +200°F],

2554: -54°C to +100°C
[-65°F to +212°F]

Application

Tractor to trailer lines, axle chamber lines and tractor service lines. For more information on specific fluid applications and high temperature ratings, see pages 349-355.

2554 Conforms to ordinance spec. MIL-H-3992B, Type 1, Class 1.

For Complete Agency Listings

See pages 346-348.

Fitting Reference Page

Reusable	
Fitting	182
Socket Data	65

Factory crimp fittings also available. Contact Eaton for details.

2570

SAE J1402 FMVSS106



# Part Number	Hose I.D.		Hose O.D.		Maximum Operating Pressure		Minimum Burst Pressure		Minimum Bend Radius		Weight of Hose	
	mm	in.	mm	in.	bar	psi	bar	psi	mm	in.	Kg/m	lbs/ft
2570-6	9,7	0.38	19,1	0.75	16,0	225	62,0	900	44,5	1.75	0,27	0.18
2570-8	12,7	0.50	22,4	0.88	16,0	225	62,0	900	50,8	2.00	0,34	0.23
2570-10†	15,7	0.62	26,9	1.06	16,0	225	62,0	900	57,2	2.25	0,44	0.30

Construction

Synthetic rubber tube, double textile braid and synthetic rubber cover.

Operating Temperature Range

-40°C to +100°C [-40°F to +212°F]

Application

Tractor to trailer lines, axle chamber lines and tractor service lines. For more information on specific fluid applications and high temperature ratings, see pages 349-355.

For Complete Agency Listings

See pages 346-348.

† Crimp Fittings only, contact Eaton Aeroquip.

Fitting Reference Page

Reusable	
Fitting	182
Socket Data	65

Factory crimp fittings also available. Contact Eaton for details.

FC629

SAE J1402 FMVSS106



# Part Number	Hose I.D.		Hose O.D.		Maximum Operating Pressure		Minimum Burst Pressure		Minimum Bend Radius		Weight of Hose	
	mm	in.	mm	in.	bar	psi	bar	psi	mm	in.	Kg/m	lbs/ft
FC629-06	9,7	0.38	19,8	0.78	15,0	225	62,0	900	44,5	1.75	0,27	0.18
FC629-08	12,7	0.50	23,1	0.91	15,0	225	62,0	900	50,8	2.00	0,30	0.20

Construction

Synthetic rubber tube, single polyester braid and synthetic rubber cover.

Operating Temperature Range

-40°C to +100°C [-40°F to +212°F]

Application

Tractor to trailer lines, axle chamber lines and tractor service lines. For more information on specific fluid applications and high temperature ratings, see pages 349-355.

For Complete Agency Listings

See pages 346-348.

Factory crimp fittings available. Contact Eaton for details.

FC829

Airbrake

SAE J1402 FMVSS106



# Part Number	Hose I.D.		Hose O.D.		Maximum Operating Pressure		Minimum Burst Pressure		Minimum Bend Radius		Weight of Hose	
	mm	in.	mm	in.	bar	psi	bar	psi	mm	in.	Kg/m	lbs/ft
FC829-08	12,7	0.50	23,1	0.91	15	225	62	900	76,2	3.00	0,27	0.18

Construction

EPDM rubber tube, double textile braids and EPDM rubber cover.

Operating Temperature Range

-40°C to +100°C [-40°F to +212°F]

Application

Tractor to trailer lines, axle chamber lines and tractor service lines. For more information on specific fluid applications and high temperature ratings, see pages 349-355.

For Complete Agency Listings

See pages 346-348.

Factory crimp fittings available.

Contact Eaton for details.

1531/1531A

Railroad Airbrake

Exceeds AAR-M618



# Part Number	Hose I.D.		Hose O.D.		Maximum Operating Pressure		Minimum Burst Pressure		Minimum Bend Radius		Weight of Hose	
	mm	in.	mm	in.	bar	psi	bar	psi	mm	in.	Kg/m	lbs/ft
1531-10‡	12,7	0.50	23,9	0.94	21,0	300	84,0	1200	139,7	5.50	0,57	0.38
1531-12	16,0	0.63	28,4	1.12	21,0	300	84,0	1200	165,1	6.50	0,71	0.48
1531-16‡	22,4	0.88	35,1	1.38	21,0	300	84,0	1200	187,5	7.38	1,07	0.72
1531-20	28,7	1.13	41,4	1.63	21,0	300	84,0	1200	241,3	9.50	1,16	0.78
1531A-24‡	35,1	1.38	47,8	1.88	21,0	300	84,0	1200	266,7	10.50	1,55	1.04

Construction

Synthetic rubber tube, partial textile braid, wire reinforcement (1531-10 and 1531-12 have single wire braid; 1531-16, 1531-20 and 1531A-24 have double wire braid) and synthetic rubber cover.

Operating Temperature Range

-54°C to +100°C [-65°F to +212°F]

Application

Locomotive airbrake lines. For more information on specific fluid applications and high temperature ratings, see pages 349-355.

For Complete Agency Listings

See pages 346-348.

Fitting Reference Page

Reusable	Page
Fitting	185
Socket Data	65

‡ Crimp fittings also available for these sizes. Contact Eaton for information.

FC355 AQP Engine & Airbrake

FMVSS106



# Part Number	Hose I.D.		Hose O.D.		Maximum Operating Pressure		Minimum Burst Pressure		Minimum Bend Radius		Vacuum Service		Weight of Hose	
	mm	in	mm	in	bar	psi	bar	psi	mm	in	kPa	in/Hg	Kg/m	lbs/ft
FC355-04	4,8	0.19	13,2	0.52	105,0	1500	420,0	6000	19,1	0.75	94,8	28	0,22	0.17
FC355-05	6,4	0.25	14,7	0.58	105,0	1500	420,0	6000	25,4	1.00	94,8	28	0,34	0.20
FC355-06	7,9	0.31	17,3	0.68	105,0	1500	420,0	6000	31,8	1.25	94,8	28	0,35	0.24
FC355-08	10,4	0.41	19,6	0.77	87,0	1250	350,0	5000	44,5	1.75	94,8	28	0,43	0.29
FC355-10	12,7	0.50	23,9	0.94	87,0	1250	350,0	5000	57,2	2.25	94,8	28	0,59	0.40
FC355-12	16,0	0.63	27,4	1.08	52,0	750	210,0	3000	69,9	2.75	67,7	20	0,68	0.46
FC355-16	22,4	0.88	31,5	1.24	28,0	400	112,0	1600	88,9	3.50	50,8	15	0,74	0.50
FC355-20	28,7	1.13	38,6	1.52	21,0	300	87,0	1250	114,3	4.50	50,8	15	0,87	0.59
FC355-24	35,1	1.38	44,5	1.75	17,0	250	70,0	1000	139,7	5.50	37,2	11	1,02	0.69
FC355-32	46,0	1.81	56,4	2.22	14,0	200	56,0	800	215,9	8.50	37,2	11	1,37	0.93

Construction

AQP elastomer tube, polyester inner braid and a single wire braid reinforcement, blue AQP elastomer cover.

Operating Temperature Range

-40°C to +150°C [-40°F to +300°F]

Air not to exceed 250 psi or +250°C [+121°F].

Application

Air, gasoline, fuel, lubricating oils and coolants. For more information on specific fluid applications and high temperature ratings, see pages 349-355.

For Complete Agency Listings

See pages 346-348.

Fitting Reference Page

<i>Crimp</i>	
100R5	134
<i>Reusable</i>	
Fitting	136
Socket Data	65

FC350 AQP Engine & Airbrake

FMVSS106



# Part Number	Hose I.D.		Hose O.D.		Maximum Operating Pressure		Minimum Burst Pressure		Minimum Bend Radius		Vacuum Service		Weight of Hose	
	mm	in	mm	in	bar	psi	bar	psi	mm	in	kPa	in/Hg	Kg/m	lbs/ft
FC350-04	4,8	0.19	13,2	0.52	140,0	2000	560,0	8000	19,1	0.75	94,8	28	0,22	0.13
FC350-05	6,4	0.25	14,7	0.58	105,0	1500	420,0	6000	25,4	1.00	94,8	28	0,34	0.16
FC350-06	7,9	0.31	17,3	0.68	105,0	1500	420,0	6000	31,8	1.25	94,8	28	0,35	0.20
FC350-08	10,4	0.41	19,6	0.77	87,0	1250	350,0	5000	44,5	1.75	94,8	28	0,43	0.23
FC350-10	12,7	0.50	23,9	0.94	87,0	1250	350,0	5000	57,2	2.25	94,8	28	0,59	0.33
FC350-12	16,0	0.63	27,4	1.08	52,0	750	210,0	3000	69,9	2.75	67,7	20	0,68	0.39
FC350-16	22,4	0.88	31,2	1.23	28,0	400	112,0	1600	88,9	3.50	50,8	15	0,74	0.50
FC350-20	28,4	1.12	38,1	1.50	21,0	300	84,0	1200	114,3	4.50	50,8	15	0,87	0.56
FC350-24	35,1	1.38	44,5	1.75	17,0	250	70,0	1000	139,7	5.50	37,2	11	1,02	0.63

Construction

AQP elastomer tube, polyester inner braid and a single wire braid reinforcement; black polyester textile braided cover.

Operating Temperature Range

-49°C to +150°C [-55°F to +300°F]

Air not to exceed +121°C [+250°F].

Application

Air, gasoline, fuel lubricating oils and coolants. For more information on specific fluid applications and high temperature ratings, see pages 349-355.

For Complete Agency Listings

See pages 346-348.

Fitting Reference Page

<i>Crimp</i>	
100R5	134
<i>Reusable</i>	
Fitting	136
Socket Data	65

FC650 AQP

High temperature fuel & oil



# Part Number	Hose I.D.		Hose O.D.		Maximum Operating Pressure		Minimum Burst Pressure		Minimum Bend Radius		Vacuum Service		Weight of Hose	
	mm	in	mm	in	bar	psi	bar	psi	mm	in	kPa	in/Hg	Kg/m	lbs/ft
FC650-04	4,8	0.19	12,2	0.48	70,0	1000	280,0	4000	19,1	0.75	94,8	28	0,15	0.10
FC650-06	7,9	0.31	16,0	0.63	70,0	1000	280,0	4000	31,8	1.25	94,8	28	0,22	0.15
FC650-08	10,4	0.41	18,8	0.74	70,0	1000	280,0	4000	44,5	1.75	94,8	28	0,28	0.19
FC650-10	12,7	0.50	21,1	0.83	70,0	1000	280,0	4000	57,2	2.25	94,8	28	0,34	0.23
FC650-12	16,0	0.63	25,1	0.99	70,0	1000	280,0	4000	69,9	2.75	67,7	20	0,41	0.28

Construction

AQP elastomer tube, single wire braid reinforcement, black polyester braided cover.

Operating Temperature Range

-49°C to +150°C [-55°F to +300°F]
Air not to exceed +121°C [+250°F].

Application

Diesel fuel, gasoline, lubricating oils, water, coolant and air. Not approved for airbrake applications. For more information on specific fluid applications and high temperature ratings, see pages 349-355.

For Complete Agency Listings

See pages 346-348.

Factory crimp fittings available.

Contact Eaton for details.

FC699 AQP

High temperature fuel



AQP lightweight engine hose

# Part Number	Hose I.D.		Hose O.D.		Maximum Operating Pressure		Minimum Burst Pressure		Minimum Bend Radius		Vacuum Service		Weight of Hose	
	mm	in	mm	in	bar	psi	bar	psi	mm	in	kPa	in/Hg	Kg/m	lbs/ft
FC699-04	6,4	0.25	12,4	0.49	28,0	400	112,0	1600	31,8	1.25	94,8	28	0,09	0.06
FC699-06	9,7	0.38	16,0	0.63	28,0	400	112,0	1600	38,1	1.50	94,8	28	0,15	0.10
FC699-08	12,7	0.50	19,6	0.77	28,0	400	112,0	1600	50,8	2.00	94,8	28	0,19	0.13
FC699-10	16,0	0.63	23,9	0.94	24,0	350	98,0	1400	63,5	2.50	61,0	18	0,27	0.18
FC699-12	19,1	0.75	27,4	1.08	24,0	350	98,0	1400	76,2	3.00	61,0	18	0,30	0.20
FC699-16	25,4	1.00	33,8	1.33	17,0	250	70,0	1000	114,3	4.50	61,0	18	0,41	0.28

Construction

AQP elastomer tube, single aramid reinforcement braid and textile braided cover.

Operating Temperature Range

-40°C to +150°C [-40°F to +300°F]
Air not to exceed 250 psi or +250°C [+121°F].

Application

Diesel fuel, gasoline, crude and lubricating oils. For more information on specific fluid applications and high temperature ratings, see pages 349-355.

For Complete Agency Listings

See pages 346-348.

Fitting Reference Page

Crimp	
OTC	66

FC234 AQP

High temperature fuel and oil

Fire resistant USCG/MMT, NMMA/BIA



# Part Number	Hose I.D.		Hose O.D.		Maximum Operating Pressure		Minimum Burst Pressure		Minimum Bend Radius		Vacuum Service		Weight of Hose	
	mm	in	mm	in	bar	psi	bar	psi	mm	in	kPa	in/Hg	Kg/m	lbs/ft
FC234-05	6,4	0.25	14,7	0.58	105,0	1500	420,0	6000	25,4	1.00	94,8	28	0,32	0.22
FC234-06	7,9	0.31	17,3	0.68	105,0	1500	420,0	6000	31,8	1.25	94,8	28	0,37	0.25
FC234-08	10,4	0.41	19,3	0.76	87,0	1250	350,0	5000	44,5	1.75	94,8	28	0,44	0.30
FC234-10	12,7	0.50	23,9	0.94	87,0	1250	350,0	5000	57,2	2.25	94,8	28	0,66	0.45
FC234-12	16,0	0.63	27,4	1.08	52,0	750	210,0	3000	69,9	2.75	67,7	20	0,71	0.48
FC234-16	22,4	0.88	31,5	1.24	28,0	400	112,0	1600	88,9	3.50	54,2	16	0,75	0.51

Construction

AQP elastomer tube, brass plated steel wire reinforcement, braided refractory insulation and blue AQP elastomer cover.

Operating Temperature Range

-40°C to +150°C [-40°F to +300°F]

Application

Diesel fuel, gasoline, hot lube oil and water. For more information on specific fluid applications and high temperature ratings, see pages 349-355.

For Complete Agency Listings

See pages 346-348.

Fitting Reference Page

<i>Crimp</i>	
100R5	134
<i>Reusable</i>	
Fitting	136
Socket Data	65

2651

Single wire braid

SAE 100R5 performance



# Part Number	Hose I.D.		Hose O.D.		Maximum Operating Pressure		Minimum Burst Pressure		Minimum Bend Radius		Vacuum Service		Weight of Hose	
	mm	in	mm	in	bar	psi	bar	psi	mm	in	kPa	in/Hg	Kg/m	lbs/ft
2651-4	4,8	0.19	13,2	0.52	210,0	3000	840,0	12000	76,2	3.00	94,8	28	0,19	0.13
2651-5	6,4	0.25	14,7	0.58	210,0	3000	840,0	12000	85,9	3.38	94,8	28	0,24	0.16
2651-6	7,9	0.31	17,3	0.68	157,0	2250	630,0	9000	101,6	4.00	94,8	28	0,34	0.23
2651-8	10,4	0.41	19,1	0.75	140,0	2000	560,0	8000	117,3	4.62	94,8	28	0,38	0.26
2651-10	12,7	0.50	23,4	0.92	122,0	1750	490,0	7000	139,7	5.50	94,8	28	0,55	0.37
2651-12	16,0	0.63	27,4	1.08	105,0	1500	420,0	6000	165,1	6.50	94,8	28	0,68	0.46
2651-16	22,4	0.88	31,2	1.23	56,0	800	224,0	3200	187,5	7.38	67,7	20†	0,65	0.44
2651-20	28,4	1.12	38,1	1.50	43,0	625	175,0	2500	228,6	9.00	67,7	20†	0,77	0.52
2651-24	35,1	1.38	44,5	1.75	35,0	500	140,0	2000	266,7	10.50	50,8	15†	0,99	0.67
2651-32	46,0	1.81	56,4	2.22	24,0	350	98,0	1400	336,6	13.25	37,3	11†	1,39	0.94
2651-40	60,1	2.38	73,2	2.88	24,0	350	98,0	1400	609,6	24.00	37,3	11†	2,11	1.43

Construction

Synthetic rubber tube, textile inner braid, single wire braid reinforcement, outer textile braid and synthetic rubber cover.

Operating Temperature Range

-40°C to +100°C [-40°F to +212°F]

Application

Hydraulics, gasoline, fuel and lubricating oils, air and water. Air not to exceed 250 psi or +71°C [+160°F]. For more information on specific fluid applications and high temperature ratings, see pages 349-355.

For Complete Agency Listings

See pages 346-348.

†Maximum negative pressures shown for -16 and larger are suitable for hose which has suffered no external damage or kinking. If greater negative pressures are required for -16 and larger hoses, the use of an internal support coil is recommended.

Fitting Reference Page

<i>Reusable</i>	
Fitting	136
Socket Data	65

303/302A Single wire braid

MIL-DTL-8794



# Part Number	Hose I.D.		Hose O.D.		Maximum Operating Pressure		Minimum Burst Pressure		Minimum Bend Radius		Vacuum Service		Weight of Hose	
	mm	in	mm	in	bar	psi	bar	psi	mm	in	kPa	in/Hg	Kg/m	lbs/ft
303-4	4,8	0.19	13,2	0.52	210,0	3000	840,0	12000	76,2	3.00	94,8	28	0,22	0.15
303-5	6,4	0.25	14,7	0.58	210,0	3000	700,0	10000	85,9	3.38	94,8	28	0,28	0.19
303-6	7,9	0.31	17,3	0.68	140,0	2000	630,0	9000	101,6	4.00	94,8	28	0,32	0.22
303-8	10,4	0.41	19,6	0.77	140,0	2000	560,0	8000	117,3	4.62	94,8	28	0,38	0.26
303-10	12,7	0.50	23,4	0.92	122,0	1750	490,0	7000	139,7	5.50	94,8	28	0,53	0.36
303-12	16,0	0.63	27,4	1.08	105,0	1500	420,0	6000	165,1	6.50	94,8	28	0,62	0.46
302A-16	22,4	0.88	31,2	1.23	56,0	800	224,0	3200	187,5	7.38	94,8	28	0,55	0.44
302A-20	28,4	1.12	38,1	1.50	42,0	600	175,0	2500	228,6	9.00	94,8	28	0,68	0.52
302A-24	35,1	1.38	44,5	1.75	35,0	500	140,0	2000	279,4	11.00	94,8	28	0,81	0.67
302A32	46,0	1.81	56,4	2.22	24,0	350	98,0	1400	336,6	13.25	94,8	28	1,15	0.94

Construction
Synthetic rubber tube, textile inner braid, single wire braid reinforcement and black textile braid cover.

Operating Temperature Range
303 hose: -54°C to +121°C
[65°F to +250°F]

302A hose: -40°C to +121°C
[-40°F to +250°F]

Application
Hydraulics, air, gasoline, fuel and lubricating oils. Air not to exceed +71°C [+160°F]. For more information on specific fluid applications and high temperature ratings, see pages 349-355.

For Complete Agency Listings
See pages 346-348.

Fitting Reference	Page
Reusable	
Fitting	136
Socket Data	65

1503 Single wire braid

SAE 100R5



# Part Number	Hose I.D.		Hose O.D.		Maximum Operating Pressure		Minimum Burst Pressure		Minimum Bend Radius		Vacuum Service		Weight of Hose	
	mm	in	mm	in	bar	psi	bar	psi	mm	in	kPa	in/Hg	Kg/m	lbs/ft
1503-4	4,8	0.19	13,2	0.52	210,0	3000	840,0	12000	76,2	3.00	94,8	28	0,19	0.13
1503-5	6,4	0.25	14,7	0.58	210,0	3000	840,0	12000	85,9	3.38	94,8	28	0,24	0.16
1503-6	7,9	0.31	17,3	0.68	157,0	2250	630,0	9000	101,6	4.00	94,8	28	0,27	0.23
1503-8	10,4	0.41	19,6	0.77	140,0	2000	560,0	8000	117,3	4.62	94,8	28	0,32	0.26
1503-10	12,7	0.50	23,4	0.92	122,0	1750	490,0	7000	139,7	5.50	94,8	28	0,49	0.37
1503-12	16,0	0.63	27,4	1.08	105,0	1500	420,0	6000	165,1	6.50	94,8	28	0,58	0.46
1503-16	22,4	0.88	31,2	1.23	56,0	800	224,0	3200	187,5	7.38	67,7	20†	0,55	0.44
1503-20	28,4	1.12	38,1	1.50	43,0	625	175,0	2500	228,6	9.00	67,7	20†	0,68	0.52
1503-24	35,1	1.38	44,5	1.75	35,0	500	140,0	2000	266,7	10.50	50,8	15†	0,92	0.67
1503-32	46,0	1.81	56,6	2.23	24,0	350	98,0	1400	366,6	13.25	37,3	11†	1,28	0.94
1503-40	60,1	2.38	73,2	2.88	24,0	350	98,0	1400	609,6	24.00	37,3	11†	2,11	1.43

Construction
Synthetic rubber tube, textile inner braid, single wire braid reinforcement and black textile braid cover.

Operating Temperature Range
-40°C to +121°C [-40°F to +250°F]

Air not to exceed +71°C [+160°F].

Application
Hydraulics, air, gasoline, fuel and lubricating oils. For more information on specific fluid applications and high temperature ratings, see pages 349-355.

†Maximum negative pressures shown for -16 and larger are suitable only for those which has suffered no external damage or kinking. If greater negative pressures are required for -16 and larger hoses, the use of an internal support coil is recommended.

For Complete Agency Listings
See pages 346-348.

Fitting Reference	Page
Crimp	
100R5	134
Reusable	
Fitting	136
Socket Data	65

SPECIALTY & TRUCK HOSE
 LOW & MEDIUM PRESSURE HOSE
 HIGH PRESSURE HOSE
 HOSE FITTINGS
 ADAPTERS & TUBE FITTINGS
 ACCESSORIES & ASSEMBLY INSTRUCTIONS
 HOSE ASSEMBLY EQUIPMENT
 APPENDICES

FC300 AQP Single wire braid

Exceeds SAE 100R5



# Part Number	Hose I.D.		Hose O.D.		Maximum Operating Pressure		Minimum Burst Pressure		Minimum Bend Radius		Vacuum Service		Weight of Hose	
	mm	in	mm	in	bar	psi	bar	psi	mm	in	kPa	in/Hg	Kg/m	lbs/ft
FC300-04	4,8	0.19	13,2	0.52	210,0	3000	840,0	12000	76,2	3.00	94,8	28	0,19	0.13
FC300-05	6,4	0.25	14,7	0.58	210,0	3000	840,0	12000	85,9	3.38	94,8	28	0,24	0.16
FC300-06	7,9	0.31	17,3	0.67	157,0	2250	630,0	9000	101,6	4.00	94,8	28	0,27	0.23
FC300-08	10,4	0.41	19,6	0.76	140,0	2000	560,0	8000	117,3	4.62	94,8	28	0,32	0.26
FC300-10	12,7	0.50	23,4	0.93	122,0	1750	490,0	7000	139,7	5.50	94,8	28	0,49	0.37
FC300-12	16,0	0.63	27,4	1.08	105,0	1500	420,0	6000	165,1	6.50	94,8	28	0,58	0.46
FC300-16	22,4	0.88	31,2	1.27	56,0	800	224,0	3200	187,5	7.38	67,7	20†	0,55	0.44
FC300-20	28,4	1.12	38,1	1.50	43,0	625	175,0	2500	228,6	9.00	67,7	20†	0,68	0.52
FC300-24	35,1	1.38	44,5	1.75	35,0	500	140,0	2000	266,7	10.50	50,8	15†	0,92	0.67
FC300-32‡	46,0	1.81	56,4	2.22	21,0	300	84,0	1200	336,6	13.25	37,3	11†	1,28	0.94
FC300-40‡	60,1	2.38	73,2	2.88	21,0	300	84,0	1200	609,6	24.00	27,1	8†	2,11	1.50

Construction

AQP elastomer tube, polyester inner braid, single wire braid reinforcement and blue polyester braid cover.

Operating Temperature Range

-49°C to +150°C [-55°F to +300°F]

Air not to exceed +121°C [+250°F].

Application

Hydraulics handling petroleum base fluids and air, gasoline, fuel and lubricating oils, fire resistant hydraulic fluids and other industrial fluids. For more information on specific fluid applications and high temperature ratings, see pages 349-355.

†Maximum negative pressure shown for -16 and larger are suitable for those which has suffered no external damage or kinking. If greater negative pressures are required for -16 and larger hoses, the use of an internal support coil is recommended.

‡ Does not comply with SAE 100R5 operating pressure of 350 psi or minimum burst of 1400 psi.

For Complete Agency Listings
See pages 346-348.

Fitting Reference Page

Crimp	
100R5	134
Reusable	
Fitting	136
Socket Data	65

FC321 LPG UL listing MH6044



# Part Number	Hose I.D.		Hose O.D.		Maximum Operating Pressure		Minimum Burst Pressure		Minimum Bend Radius		Weight of Hose	
	mm	in	mm	in	bar	psi	bar	psi	mm	in	Kg/m	lbs/ft
FC321-04	4,8	0.19	13,2	0.52	24,0	350	122,0	1750	38,1	1.50	0,16	0.11
FC321-05	6,4	0.25	14,7	0.58	24,0	350	122,0	1750	44,5	1.75	0,19	0.13
FC321-06	7,9	0.31	17,0	0.67	24,0	350	122,0	1750	50,8	2.00	0,27	0.18
FC321-08	10,4	0.41	19,6	0.77	24,0	350	122,0	1750	58,7	2.31	0,31	0.21
FC321-10	12,7	0.50	23,4	0.92	24,0	350	122,0	1750	69,9	2.75	0,43	0.29
FC321-12	16,0	0.63	27,4	1.08	24,0	350	122,0	1750	82,6	3.25	0,55	0.37
FC321-16	22,4	0.88	31,5	1.24	24,0	350	122,0	1750	93,7	3.69	0,56	0.38

Construction

Synthetic rubber tube, a textile inner braid, a stainless steel wire braid reinforcement and a synthetic rubber impregnated textile braid cover.

Operating Temperature Range

-40°C to +121°C [-40°F to +250°F]

Application

Designed for butane-propane applications on either mobile or stationary equipment. For more information on specific fluid applications and high temperature ratings, see pages 349-355.

WARNING: LPG is a very hazardous liquid or gas and should be handled with maximum care to prevent leakage. Since the gas is heavier than air, it may flow along the ground if it escapes and cause an explosion or a fire. No leakage should ever be tolerated.

For Complete Agency Listings
See pages 346-348.

Fitting Reference Page

Reusable	
Fitting	136
Socket Data	65

CR170 LPG Single stainless steel braid

CGA (Canadian Gas Association) Type III



# Part Number	Hose I.D.		Hose O.D.		Maximum Operating Pressure		Minimum Burst Pressure		Minimum Bend Radius		Weight of Hose	
	mm	in	mm	in	bar	psi	bar	psi	mm	in	Kg/m	lbs/ft
CR170-04	4,8	0.19	13,2	0.52	24,0	350	840,0	12000	76,2	3.00	0,24	0.16
CR170-06	7,9	0.31	17,0	0.67	24,0	350	630,0	9000	101,6	4.00	0,32	0.22
CR170-08	10,4	0.41	19,6	0.77	24,0	350	560,0	8000	117,3	4.62	0,38	0.26
CR170-12	15,9	0.63	28,0	1.10	24,0	350	414,0	6000	165,1	6.50	0,71	0.48

Construction

Nylon tube, single stainless steel braid reinforcement, perforated synthetic rubber cover.

Operating Temperature Range

-40°C to +121°C [-40°F to +250°F]

Application

LPG (propane) vehicle, alternative fuel conversion systems. For more information on specific fluid applications and high temperature ratings, see pages 349-355.

WARNING: LPG is a very hazardous liquid or gas and should be handled with maximum care to prevent leakage. Since the gas is heavier than air, it may flow along the ground if it escapes and cause an explosion or a fire. No leakage should ever be tolerated.

Factory crimp fittings available. Contact Eaton for details.

For Complete Agency Listings

See pages 346-348.

NOTE: Must be CGA certified to crimp assemblies.

2807 PTFE

SAE 100R14A



# Part Number	Hose I.D.		Hose O.D.		Maximum Operating Pressure		Minimum Burst Pressure		Minimum Bend Radius		Vacuum Service		Weight of Hose	
	mm	in	mm	in	bar	psi	bar	psi	mm	in	kPa	in/Hg	Kg/m	lbs/ft
2807-03	3,6	0.14	6,4	0.25	210,0	3000	840,0	12000	38,1	1.50	94,8	28	0,06	0.04
2807-04	4,8	0.19	7,6	0.30	210,0	3000	840,0	12000	50,8	2.00	94,8	28	0,09	0.06
2807-05	6,6	0.26	9,4	0.37	210,0	3000	840,0	12000	76,2	3.00	94,8	28	0,12	0.08
2807-06	8,1	0.32	10,9	0.43	175,0	2500	700,0	10000	101,6	4.00	94,8±	28±	0,15	0.10
2807-08	10,7	0.42	13,7	0.54	140,0	2000	560,0	8000	133,4	5.25	94,8±	28±	0,18	0.12
2807-10	13,0	0.51	16,0	0.63	105,0	1500	420,0	6000	165,1	6.50	94,8±	28±	0,24	0.16
2807-12	16,3	0.64	19,3	0.76	84,0	1200	335,0	4800	196,9	7.75	94,8±	28±	0,27	0.18
2807-16	22,4	0.88	26,2	1.03	70,0	1000	280,0	4000	228,6	9.00	40,6±	12±	0,39	0.26
2807-20	28,4	1.12	32,8	1.29	43,0	625	175,0	2500	406,4	16.00	40,6±	12±	0,51	0.34

Construction

Extruded PTFE tube with stainless steel single wire braid.

Operating Temperature Range

-73°C to +260°C [-100°F to +500°F]

Application

Hot air, steam, compressor discharge and most chemical applications. Not recommended for steam-cold water cycling. For more information on specific fluid applications and high temperature ratings, see pages 349-355.

† Steam 200 psi at +388°F max. Engineering information is available for specific critical temperature requirements. Contact Eaton.

‡Maximum negative pressure for -06 and larger are suitable for hose which has suffered no external damage or kinking. If greater negative pressures are required for -06 and larger hoses, the use of an internal support coil is recommended. Use of an internal support coil in -06 and larger PTFE hose is recommended for tube support where extended or continuous service at high temperature together with low or negative pressure is expected.

Fitting Reference Page

<i>Crimp</i>	
Fitting	129
Socket Data	64
<i>Reusable</i>	
Fitting	186
Socket Data	65

For Complete Agency Listings

See pages 346-348.

FC807 PTFE

SAE 100R14A



# Part Number	Hose I.D.		Hose O.D.		Maximum Operating Pressure		Minimum Burst Pressure		Minimum Bend Radius		Vacuum Service		Weight of Hose	
	mm	in	mm	in	bar	psi	bar	psi	mm	in	kPa	in/Hg	Kg/m	lbs/ft
2807-04	4,8	0.19	7,6	0.30	210,0	3000	840,0	12000	50,8	2.00	94,8	28	0,09	0.06
2807-05	6,6	0.26	9,4	0.37	210,0	3000	840,0	12000	76,2	3.00	94,8	28	0,12	0.08
2807-06	8,1	0.32	10,9	0.43	175,0	2500	700,0	10000	101,6	4.00	94,8†	28†	0,15	0.10
2807-08	10,7	0.42	13,7	0.54	140,0	2000	560,0	8000	133,4	5.25	94,8†	28†	0,18	0.12
2807-10	13,0	0.51	16,0	0.63	105,0	1500	420,0	6000	165,1	6.50	94,8†	28†	0,24	0.16
2807-12	16,3	0.64	19,3	0.76	84,0	1200	335,0	4800	196,9	7.75	94,8†	28†	0,27	0.18
2807-16	22,4	0.88	26,2	1.03	70,0	1000	280,0	4000	228,6	9.00	40,6†	12†	0,35	0.26

Construction

Extruded PTFE tube with stainless steel single wire braid and one end of Red Nomex*.

Operating Temperature Range

-54°C to +230°C [-65°F to +450°F]

Application

Hot air, steam, compressor discharge and most chemical applications. Not recommended for steam-cold water cycling. For more information on specific fluid applications and high temperature ratings, see pages 349-355.

*Nomex is a trademark of E.I. DuPont.

‡ Maximum negative pressure for -16 and larger are suitable for hose which has suffered no external damage or kinking. If greater negative pressures are required for -16 and larger hoses, the use of an internal support coil is recommended. Use of an internal support coil in -06 and larger PTFE hose is recommended for tube support where extended or continuous service at high temperature together with low or negative pressure is expected.

For Complete Agency Listings
See pages 346-348.

Fitting Reference Page

<i>Crimp</i>	
Fitting	129
Socket Data	64
<i>Reusable</i>	
Fitting	186
Socket Data	65

FC465 PTFE

Conductive SAE 100R14B



# Part Number	Hose I.D.		Hose O.D.		Maximum Operating Pressure		Minimum Burst Pressure		Minimum Bend Radius		Vacuum Service		Weight of Hose	
	mm	in	mm	in	bar	psi	bar	psi	mm	in	kPa	in/Hg	Kg/m	lbs/ft
FC465-03	3,6	0.14	6,4	0.25	210,0	3000	840,0	12000	38,1	1.50	94,8	28	0,06	0.04
FC465-04	4,8	0.19	7,6	0.30	210,0	3000	840,0	12000	50,8	2.00	94,8	28	0,09	0.06
FC465-05	6,6	0.26	9,4	0.37	210,0	3000	840,0	12000	76,2	3.00	94,8	28	0,12	0.08
FC465-06	8,1	0.32	10,9	0.43	175,0	2500	700,0	10000	101,6	4.00	94,8†	28†	0,15	0.10
FC465-08	10,7	0.42	13,7	0.54	140,0	2000	560,0	8000	133,4	5.25	94,8†	28†	0,18	0.12
FC465-10	13,0	0.51	16,0	0.63	105,0	1500	420,0	6000	165,1	6.50	94,8†	28†	0,24	0.16
FC465-12	16,3	0.64	19,3	0.76	84,0	1200	335,0	4800	196,9	7.75	94,8†	28†	0,27	0.18
FC465-16	22,4	0.88	26,2	1.03	70,0	1000	280,0	4000	228,6	9.00	40,6†	12†	0,39	0.26
FC465-20	28,4	1.12	32,8	1.29	43,0	625	175,0	2500	406,4	16.00	40,6†	12†	0,51	0.34

Construction

Conductive extruded black PTFE tube with stainless steel single wire braid.

Operating Temperature Range

-73°C to +260°C [-100°F to +500°F]

Application

Steam, compressor discharge and most chemical applications. Not recommended for steam-cold water cycling. For more information on specific fluid applications and high temperature ratings, see pages 349-355.

† Steam 200 psi at +388°F max. Engineering information is available for specific critical temperature requirements. Contact Eaton.

‡ Maximum negative pressure for -06 and larger are suitable for hose which has suffered no external damage or kinking. If greater negative pressures are required for -06 and larger hoses, the use of an internal support coil is recommended. Use of an internal support coil in -06 and larger PTFE hose is recommended for tube support where extended or continuous service at high temperature together with low or negative pressure is expected.

For Complete Agency Listings
See pages 346-348.

Fitting Reference Page

<i>Crimp</i>	
Fitting	129
Socket Data	64
<i>Reusable</i>	
Fitting	186
Socket Data	65

2808 PTFE



# Part Number	Hose I.D.		Hose O.D.		Maximum Operating Pressure		Minimum Burst Pressure		Minimum Bend Radius		Vacuum Service		Weight of Hose	
	mm	in	mm	in	bar	psi	bar	psi	mm	in	kPa	in/Hg	Kg/m	lbs/ft
2808-08	10,7	0.42	14,7	0.58	190,0	2750	758,0	11000	117,3	4.62	94,8†	28†	0,30	0.20
2808-10	12,9	0.51	17,3	0.68	172,0	2500	689,0	10000	139,7	5.50	94,8†	28†	0,39	0.26
2808-12	16,5	0.65	20,6	0.81	121,0	1750	483,0	7000	165,1	6.50	67,7†	20†	0,45	0.30
2808-16	22,3	0.88	27,7	1.09	103,0	1500	414,0	6000	187,4	7.38	50,8†	15†	0,65	0.44
2808-20	28,4	1.12	34,3	1.35	78,0	1125	310,0	4500	279,4	11.00	50,8†	15†	0,85	0.57
2808-24	35,0	1.38	41,1	1.62	55,0	800	221,0	3200	355,6	14.00	50,8†	15†	1,04	0.70

Construction

Extruded PTFE tube with double stainless steel braids.

Operating Temperature Range

-73°C to +260°C [-100°F to +500°F]

Application

Hot air, steam and most chemical applications. Not recommended for steam-cold water cycling. For more information on specific fluid applications and high temperature ratings, see pages 400-404.

† Steam 200 psi at +388°F max. Engineering information is available for specific critical temperature requirements. Contact Eaton.

‡Maximum negative pressure for -08 and larger are suitable for hose which has suffered no external damage or kinking. If greater negative pressures are required for -08 and larger hoses, the use of an internal support coil is recommended. Use of an internal support coil in -08 and larger PTFE hose is recommended for tube support where extended or continuous service at high temperature together with low or negative pressure is expected.

For Complete Agency Listings

See pages 397-398.

Fitting Reference Page

Reusable	Page
Fitting	175
Socket Data	65

FC469 PTFE



Conductive

# Part Number	Hose I.D.		Hose O.D.		Maximum Operating Pressure		Minimum Burst Pressure		Minimum Bend Radius		Vacuum Service		Weight of Hose	
	mm	in.	mm	in.	bar	psi	bar	psi	mm	in.	kPa	in/Hg	Kg/m	lbs/ft
FC469-06	7,6	0.30	12,2	0.48	280,0	4000	1120,0	16000	63,5	2.50	94,8†	28†	0,25	0.17
FC469-08	9,9	0.39	15,5	0.61	280,0	4000	1120,0	16000	73,2	2.88	94,8†	28†	0,36	0.24
FC469-10	12,4	0.49	18,3	0.72	245,0	3500	980,0	14000	82,6	3.25	94,8†	28†	0,43	0.29

Construction

Conductive extruded PTFE tube with stainless steel single wire braid.

Operating Temperature Range

-54°C to +204°C [-65°F to +400°F]

Application

High pressure chemical and fluid transfer. For information on specific fluid applications and high temperature ratings, see pages 400-404.

† Steam 200 psi at +388°F max. Engineering information is available for specific critical temperature requirements. Contact Eaton.

‡Use of an internal support coil in -06 and larger PTFE hose is recommended for tube support where extended or continuous service at high temperature together with low or negative pressure is expected.

For Complete Agency Listings

See pages 397-398.

Contact Eaton for fitting information.

FC363 Convuluted PTFE

Nonconductive tube

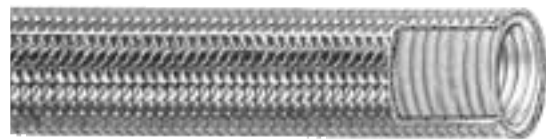

# Part Number	Hose I.D.		Hose O.D.		Maximum Operating Pressure		Minimum Burst Pressure		Minimum Bend Radius		Minimum Kink Radius		Vacuum Service	
	mm	in	mm	in	bar	psi	bar	psi	mm	in	mm	in	kPa	in/Hg
FC363-08	13,7	0.54	18,8	0.74	87,0	1250†	350,0	5000	73,2	2.88	25,4	1.00	94,8	28
FC363-12	20,6	0.81	26,9	1.06	76,0	1100†	303,0	4400	95,3	3.75	50,8	2.00	94,8	28
FC363-16	25,4	1.00	32,5	1.28	70,0	1000†	280,0	4000	127,0	5.00	63,5	2.50	81,3	24
FC363-20	31,5	1.24	38,9	1.53	70,0	1000†	280,0	4000	158,8	6.25	88,9	3.50	67,7	20
FC363-24	38,6	1.52	46,0	1.81	52,0	750†	210,0	3000	190,5	7.50	114,3	4.50	40,6	12
FC363-32	50,8	2.00	58,7	2.31	35,0	500†	140,0	2000	254,0	10.00	152,4	6.00	16,9	5

Construction

Convuluted PTFE tube with stainless steel single wire braid cover.

Operating Temperature Range

-54°C to +204°C [-65°F to +400°F]

Application

Chemical, food, water and waste handling, and various transfer applications. Not recommended for steam-cold water cycling. For more information on specific fluid applications and high temperature ratings, see pages 349-355.

†Steam 200 psi at +388°F max.

Engineering information is available for specific critical temperature requirements. Contact Eaton.

Fitting Reference Page

Crimp	Page
Fitting	131
Socket Data	64

For Complete Agency Listings

See pages 346-348.

FC364 Convuluted PTFE

Conductive tube

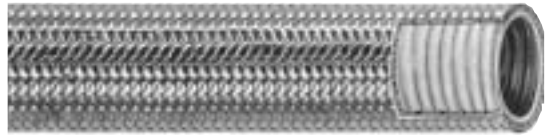

# Part Number	Hose I.D.		Hose O.D.		Maximum Operating Pressure		Minimum Burst Pressure		Minimum Bend Radius		Minimum Kink Radius		Vacuum Service	
	mm	in	mm	in	bar	psi	bar	psi	mm	in	mm	in	kPa	in/Hg
FC364-08	13,7	0.54	18,8	0.74	87,0	1250†	350,0	5000	73,2	2.88	25,4	1.00	94,8	28
FC364-12	20,6	0.81	26,9	1.06	76,0	1100†	303,0	4400	95,3	3.75	50,8	2.00	94,8	28
FC364-16	25,4	1.00	32,3	1.27	70,0	1000†	280,0	4000	127,0	5.00	63,5	2.50	81,3	24
FC364-20	31,5	1.24	38,9	1.53	70,0	1000†	280,0	4000	158,8	6.25	88,9	3.50	67,7	20
FC364-24	38,6	1.52	46,0	1.81	52,0	750†	210,0	3000	190,5	7.50	114,3	4.50	40,6	12
FC364-32	50,8	2.00	58,7	2.31	35,0	500†	140,0	2000	254,0	10.00	152,4	6.00	16,9	5
FC364-40	64,3	2.53	73,7	2.90	7,0	100	28,0	400	317,5	12.50	203,2	8.00	16,9	5
FC364-48	77,2	3.04	88,4	3.48	7,0	100	28,0	400	381,0	15.00				

Construction

Convuluted conductive PTFE tube with stainless steel wire braid cover.

Operating Temperature Range

-54°C to +204°C [-65°F to +400°F]

Application

Steam lines and fuel transfer applications where static dissipation is required. Not recommended for steam-cold water cycling. For more information on specific fluid applications and high temperature ratings, see pages 349-355.

†Steam 200 psi at +388°F max.

Engineering information is available for specific critical temperature requirements. Contact Eaton.

Fitting Reference Page

Crimp	Page
Fitting	131
Socket Data	64

For Complete Agency Listings

See pages 346-348.

FC563 Convuluted PTFE

Nonconductive tube



# Part Number	Hose I.D.		Hose O.D.		Maximum Operating Pressure		Minimum Burst Pressure		Minimum Bend Radius		Vacuum Service	
	mm	in	mm	in	bar	psi	bar	psi	mm	in	kPa	in/Hg
FC563-08	13,7	0.54	18,8	0.74	87,0	1250	350,0	5000	73,2	2.88	94,8	28
FC563-12	20,6	0.81	29,9	1.06	76,0	1100	303,0	4400	95,3	3.75	94,8	28
FC563-16	25,4	1.00	32,5	1.28	70,0	1000	280,0	4000	127,0	5.00	81,2	24
FC563-20	31,5	1.24	38,9	1.53	70,0	1000	280,0	4000	158,8	6.25	67,7	20
FC563-24	38,6	1.52	46,0	1.81	52,0	750	210,0	3000	190,5	7.50	33,9	10
FC563-32	50,8	2.00	58,7	2.31	35,0	500	140,0	2000	254,0	10.00	23,7	7

Construction

Convuluted PTFE tube with stainless steel single wire braid reinforcement and integral black polyester overbraid cover.

Operating Temperature Range

-54°C to +150°C [-65°F to +300°F]

Application

Chemical transfer and various chemical processing applications. Not recommended for steam or steam-cold water cycling. For more information on specific fluid applications and high temperature ratings, see pages 349-355.

For Complete Agency Listings

See pages 346-348.

Fitting Reference Page

Crimp	
Fitting	131
Socket Data	64

Factory crimp only.

2575 Low pressure *SOCKETLESS™* Textile Braid



# Part Number	Hose I.D.		Hose O.D.		Maximum Operating Pressure		Minimum Burst Pressure		Minimum Bend Radius		Weight of Hose	
	mm	in	mm	in	bar	psi	bar	psi	mm	in	Kg/m	lbs/ft
2575-4	6,4	0.25	11,9	0.47	17,0	250	70,0	1000	76,2	3.00	0,13	0.09
2575-6	9,7	0.38	15,8	0.62	17,0	250	70,0	1000	101,6	4.00	0,19	0.13
2575-8	12,7	0.50	19,1	0.75	17,0	250	70,0	1000	127,0	5.00	0,25	0.17
2575-10	16,0	0.63	23,1	0.91	14,0	200	56,0	800	152,4	6.00	0,30	0.20
2575-12	19,1	0.75	26,2	1.03	14,0	200	56,0	800	177,8	7.00	0,33	0.22

Construction

Synthetic rubber tube, textile braid reinforcement, black synthetic rubber cover (only).

Operating Temperature Range

-40°C to +100°C [-40°F to +212°F]

Water not to exceed +66°C [+150°F] and air not to exceed +71°C [+160°F].

Application

For gasoline, fuel and lubricating oils, air and water. Not recommended for hydraulic impulse applications and not approved for airbrake applications. For more information on specific fluid applications and high temperature ratings, see pages 349-355.

For Complete Agency Listings

See pages 346-348.

Fitting Reference Page

Reusable	
Fitting	176

FC332 AQP

Low pressure *SOCKETLESS™*

Textile Braid



# Part Number	Hose I.D.		Hose O.D.		Maximum Operating Pressure		Minimum Burst Pressure		Minimum Bend Radius		Vacuum Service		Weight of Hose	
	mm	in	mm	in	bar	psi	bar	psi	mm	in	kPa	in/Hg	Kg/m	lbs/ft
FC332-04	6,4	0.25	12,4	0.49	17,0	250	70,0	1000	76,2	3.00	94,8	28	0,12	0.08
FC332-06	9,7	0.38	16,0	0.63	17,0	250	70,0	1000	76,2	3.00	94,8	28	0,18	0.12
FC332-08	12,7	0.50	19,1	0.75	17,0	250	70,0	1000	127,0	5.00	94,8	28	0,22	0.15
FC332-10	16,0	0.63	23,1	0.91	17,0	250	70,0	1000	152,4	6.00	60,9	18	0,30	0.20
FC332-12	19,1	0.75	26,4	1.04	17,0	250	70,0	1000	177,8	7.00	60,9	18	0,42	0.28

Construction

AQP elastomer tube, textile braid reinforcement, AQP elastomer cover.

Operating Temperature Range

-40°C to +150°C [-40°F to +300°F]
Air not to exceed +121°C [+250°F] and water not to exceed +82°C [+180°F].

Application

For gasoline, fuel and lubricating oils, air and water. Not recommended for hydraulic impulse applications and not approved for airbrake applications. For more information on specific fluid applications and high temperature ratings, see pages 349-355.

For Complete Agency Listings

See pages 346-348.

Fitting Reference Page

Reusable	
Fitting	176

FC647

Low pressure *SOCKETLESS™*

Textile braid



Fire resistant meets RMA/CGA flame test requirements

# Part Number	Hose I.D.		Hose O.D.		Maximum Operating Pressure		Minimum Burst Pressure		Minimum Bend Radius		Vacuum Service		Weight of Hose	
	mm	in	mm	in	bar	psi	bar	psi	mm	in	kPa	in/Hg	Kg/m	lbs/ft
FC647-04*	6,4	0.25	13,2	0.52	25,0	360	99,0	1440	76,2	3.00	94,8	28	0,09	0.06
FC647-06*	9,7	0.38	16,8	0.66	21,0	300	84,0	1200	76,2	3.00	94,8	28	0,15	0.09
FC647-08*	12,7	0.50	20,1	0.79	21,0	300	84,0	1200	127,0	5.00	94,8	28	0,18	0.12
FC647-10*	16,0	0.63	23,4	0.92	17,0	250	70,0	1000	152,4	6.00	60,9	18	0,24	0.16
FC647-12*	19,1	0.75	26,7	1.05	17,0	250	70,0	1000	177,8	7.00	60,9	18	0,27	0.18

Construction

Synthetic rubber tube, textile braid reinforcement, polyester braided cover.

Operating Temperature Range

-40°C to +100°C [-40°F to +212°F]
Water not to exceed +66°C (+150°F),
air not to exceed +74°C (+165°F).

Application

For gasoline, fuel and lubricating oils, air and water. Not recommended for hydraulic impulse applications and not approved for airbrake applications. For more information on specific fluid applications and high temperature ratings, see pages 349-355.

**NOTE: You must insert the correct color code in the complete part number. Color codes are BLK = black, BLU = blue, BRN = brown, GRN = green, WHT = white. Example: FC647-04GRN is a green cover in dash size 4. Not all sizes are available in all colors.*

Fitting Reference Page

Reusable	
Fitting	176

For Complete Agency Listings

See pages 346-348.

2556/2565

Low pressure **SOCKETLESS™**
Textile braid

Meets performance requirements SAE 30R2 Type 1



# Part Number	Hose I.D.		Hose O.D.		Maximum Operating Pressure		Minimum Burst Pressure		Minimum Bend Radius		Vacuum Service		Weight of Hose	
	mm	in	mm	in	bar	psi	bar	psi	mm	in	kPa	in/Hg	Kg/m	lbs/ft
2556-4	6,4	0.25	12,4	0.49	25,0	360	99,0	1440	76,2	3.00	94,8	28	0,12	0.08
2556-6	9,7	0.38	15,7	0.62	21,0	300	84,0	1200	76,2	3.00	94,8	28	0,18	0.12
2556-8	12,7	0.50	19,1	0.75	21,0	300	84,0	1200	127,0	5.00	94,8	28	0,24	0.16
2556-10	16,0	0.63	23,1	0.91	17,0	250	70,0	1000	152,4	6.00	61,0	18	0,31	0.21
2556-12	19,1	0.75	26,2	1.03	17,0	250	70,0	1000	177,8	7.00	61,0	18	0,37	0.25
2565-4	6,4	0.25	12,7	0.50	21,0	300	87,0	1250	57,2	2.25	67,7	20	0,13	0.09
2565-6	9,7	0.38	16,0	0.63	17,0	250	70,0	1000	76,2	3.00	67,7	20	0,16	0.11
2565-8	12,7	0.50	19,8	0.78	14,0	200	52,0	750	95,3	3.75	33,9	10	0,25	0.17
2565-10	16,0	0.63	24,6	0.97	12,0	175	49,0	700	120,7	4.75	33,9	10	0,42	0.28
2565-12	19,1	0.75	27,7	1.09	8,5	125	35,0	500	139,7	5.50	33,9	10	0,45	0.30

Construction

Synthetic rubber tube, textile braid reinforcement, synthetic rubber cover.

Operating Temperature Range

2556: -40°C to +100°C [-40°F to +212°F]. Water not to exceed +66°C [+150°F], air not to exceed +160°C [+71°F].

2565: -54°C to +121°C [-65°F to +250°F]. Water not to exceed +66°C [+150°F], air not to exceed +74°C [+165°F].

Application

For gasoline, fuel and lubricating oils, air and water. Not recommended for hydraulic impulse applications and not approved for airbrake applications. For more information on specific fluid applications and high temperature ratings, see pages 349-355.

2565 is a low-temperature synthetic rubber covered MIL-DTL-13444 Type 1, Class A hose.

For Complete Agency Listings

See pages 346-348.

Fitting Reference Page

Reusable	
Fitting	176

FC619
Flexible 1/2 SAE bend
Wire inserted suction



Exceeds SAE 100R4

# Part Number	Hose I.D.		Hose O.D.		Maximum Operating Pressure		Minimum Burst Pressure		Minimum Bend Radius		Vacuum Service		Weight of Hose	
	mm	in	mm	in	bar	psi	bar	psi	mm	in	kPa	in/Hg	Kg/m	lbs/ft
FC619-12	19,1	0.75	30,7	1.21	21,0	300†	84,0	1200	63,5	2.50	94,8	28	0,68	0.46
FC619-16	25,4	1.00	37,6	1.48	17,0	250†	70,0	1000	76,2	3.00	94,8	28	0,83	0.56
FC619-20	31,8	1.25	44,5	1.75	14,0	200†	56,0	800	102,0	4.00	94,8	28	1,16	0.78
FC619-24	38,1	1.50	51,8	2.04	10,5	150†	42,0	600	127,0	5.00	94,8	28	1,49	1.00
FC619-32	50,8	2.00	64,8	2.55	7,0	100†	28,0	400	152,4	6.00	94,8	28	1,83	1.23
FC619-40	63,5	2.50	79,2	3.12	4,0	62	17,0	250	355,6	14.00	94,8	28	2,35	1.58
FC619-48	76,2	3.00	95,3	3.75	4,0	62	16,0	225	457,2	18.00	94,8	28	3,36	2.26

Construction

Synthetic rubber tube, reinforcement consisting of a helical wire between two textile reinforcement layers and synthetic rubber cover.

Operating Temperature Range

-40°C to +135°C [-40°F to +275°F]

Application

Suction and transfer applications for petroleum hydraulic fluids, fuel, lubricating oils, gasoline, water and many other industrial fluids. For more information on specific fluid applications and high temperature ratings, see pages 349-355.

† Maximum working pressure for band clamp type fittings is 3,4 bar [50 psi].

NOTE: -40 and -48 sizes require special tooling for crimp fittings. Contact Eaton for information.

For Complete Agency Listings

See pages 346-348.

Fitting Reference Page

Crimp	
OTC	66
TTC	66
-40, -48	133
Socket Data	64
Reusable	
Nipple	66
Clamps	184

SPECIALTY & TRUCK HOSE
LOW & MEDIUM PRESSURE HOSE
HIGH PRESSURE HOSE
HOSE FITTINGS
ADAPTERS & TUBE FITTINGS
ACCESSORIES & ASSEMBLY INSTRUCTIONS
ECHOSE ASSEMBLY EQUIPMENT
APPENDICIES

2661 AQP

Wire inserted suction

Exceeds SAE 100R4



#	Hose I.D.		Hose O.D.		Maximum Operating Pressure		Minimum Burst Pressure		Minimum Bend Radius		Vacuum Service		Weight of Hose	
	mm	in	mm	in	bar	psi	bar	psi	mm	in	kPa	in/Hg	Kg/m	lbs/ft
2661-12	19,1	0.75	31,8	1.25	21,0	300†	84,0	1200	125,0	5.00	94,8	28	0,62	0,42
2661-16	25,4	1.00	38,1	1.50	17,0	250†	70,0	1000	150,0	6.00	94,8	28	0,74	0,50
2661-20	31,8	1.25	45,7	1.80	14,0	200†	56,0	800	200,0	8.00	94,8	28	1,34	0,90
2661-24	38,1	1.50	52,3	2.06	10,5	150†	42,0	600	255,0	10.00	94,8	28	1,68	1,13
2661-32	50,8	2.00	64,8	2.55	7,0	100†	28,0	400	300,0	12.00	94,8	28	1,93	1,30
2661-40	63,5	2.50	78,2	3.08	4,0	62	16,0	225	355,0	14.00	94,8	28	2,56	1,72
2661-48‡	76,2	3.00	90,9	3.58	4,0	62	16,0	225	460,0	18.00	94,8	28	2,92	1,96
2661-64‡	101,6	4.00	119,1	4.69	3,5	50	14,0	200	610,0	24.00	94,8	28	4,58	3,08

Construction

AQP elastomer tube, reinforcement consisting of a helical wire between two textile braids and two AQP elastomer cover.

Operating Temperature Range

-40°C to +150°C [-40°F to +300°F]

Application

Suction and transfer applications for petroleum and fire resistant hydraulic fluids, fuel, lubricating oils, gasoline, water and many other industrial fluids. For more information on specific fluid applications and high temperature ratings, see pages 349-355.

† Maximum working pressure for band clamp type fittings is 3,4 bar [50 psi].

‡ Sold as bulk hose only.

For Complete Agency Listings

See pages 346-348.

Fitting Reference Page

Fitting Reference	Page
<i>Crimp</i>	
OTC	66
TTC	66
-40, -48	133
Socket Data	64
<i>Reusable</i>	
Nipple	66
Clamps	184

FC466

Textile braid

Exceeds SAE 100R6 performance*



#	Hose I.D.		Hose O.D.		Maximum Operating Pressure		Minimum Burst Pressure		Minimum Bend Radius		Vacuum Service		Weight of Hose	
	mm	in	mm	in	bar	psi	bar	psi	mm	in	kPa	in/Hg	Kg/m	lbs/ft
FC466-04	6,4	0.25	12,2	0.48	28,0	400	112,0	1600	63,5	2.50	94,8	28	0,09	0,06
FC466-06	9,7	0.38	15,7	0.62	28,0	400	112,0	1600	75,0	3.00	94,8	28	0,15	0,10
FC466-08	12,7	0.50	19,1	0.75	28,0	400	112,0	1600	100,0	4.00	94,8	28	0,19	0,13
FC466-10	16,0	0.63	23,1	0.91	24,0	350	98,0	1400	125,0	5.00	60,9	18	0,27	0,18
FC466-12	19,1	0.75	26,2	1.03	24,0	350	98,0	1400	150,0	7.00	60,9	18	0,28	0,19

Construction

Synthetic rubber tube, textile braid reinforcement and polyester braid cover.

Operating Temperature Range

-40°C to +100°C [-40°F to +212°F], Air not to exceed -71°C [+160°F].

Application

For gasoline, fuel, lubricating oils, air and water. Not approved for airbrake applications. For more information on specific fluid applications and high temperature ratings, see pages 349-355.

* All sizes except -12

For Complete Agency Listings

See pages 346-348.

Fitting Reference Page

Fitting Reference	Page
<i>Crimp</i>	
OTC	66
Skive Nipple**	66
Socket Data	64

**No skiving required.

FC498 AQP Textile braid

Exceeds SAE 100R6



# Part Number	Hose I.D.		Hose O.D.		Maximum Operating Pressure		Minimum Burst Pressure		Minimum Bend Radius		Vacuum Service		Weight of Hose	
	mm	in	mm	in	bar	psi	bar	psi	mm	in	kPa	in/Hg	Kg/m	lbs/ft
FC498-04	6,4	0.25	12,7	0.50	28,0	400	112,0	1600	63,5	2.50	94,8	28	0,12	0.08
FC498-06	9,7	0.38	15,7	0.62	28,0	400	112,0	1600	75,0	3.00	94,8	28	0,19	0.13
FC498-08	12,7	0.50	19,1	0.75	28,0	400	112,0	1600	100,0	4.00	94,8	28	0,22	0.15
FC498-10	16,0	0.63	23,1	0.91	24,0	350	98,0	1400	125,0	5.00	60,9	18	0,30	0.20
FC498-12	19,1	0.75	26,2	1.03	24,0	350	98,0	1400	150,0	6.00	60,9	18	0,42	0.28

Construction

AQP elastomer tube, textile braid reinforcement, blue AQP elastomer cover.

Operating Temperature Range
-40°C to +150°C [-40°F to +300°F]

Application

Low pressure return lines in hydraulic systems. For more information on specific fluid applications and high temperature ratings, see pages 349-355.

For Complete Agency Listings
See pages 346-348.

Fitting Reference Page

Crimp	Page
OTC	66
Skive Nipple**	66
Socket Data	64

**No skiving required.

FC598 AQP Textile braid

Exceeds SAE 100R6



# Part Number	Hose I.D.		Hose O.D.		Maximum Operating Pressure		Minimum Burst Pressure		Minimum Bend Radius		Vacuum Service		Weight of Hose	
	mm	in	mm	in	bar	psi	bar	psi	mm	in	kPa	in/Hg	Kg/m	lbs/ft
FC598-04	6,4	0.25	12,2	0.50	28,0	400	112,0	1600	63,5	2.50	94,8	28	0,12	0.08
FC598-06	9,7	0.38	15,7	0.62	28,0	400	112,0	1600	75,0	3.00	94,8	28	0,19	0.13
FC598-08	12,7	0.50	19,1	0.78	28,0	400	112,0	1600	100,0	4.00	94,8	28	0,22	0.15
FC598-10	16,0	0.63	23,1	0.91	24,0	350	98,0	1400	125,0	5.00	60,9	18	0,30	0.20
FC598-12	19,1	0.75	26,2	1.03	24,0	350	98,0	1400	150,0	6.00	60,9	18	0,42	0.28

Construction

AQP elastomer tube, textile braid reinforcement, black AQP elastomer cover.

Operating Temperature Range
-40°C to +150°C [-40°F to +300°F]

Application

Low pressure return lines in hydraulic systems. For more information on specific fluid applications and high temperature ratings, see pages 349-355.

For Complete Agency Listings
See pages 346-348.

Fitting Reference Page

Crimp	Page
OTC	66
Skive Nipple**	66
Socket Data	64

**No skiving required.

2580 Double textile braid

MIL-H-24136/3



# Part Number	Hose I.D.		Hose O.D.		Maximum Operating Pressure		Minimum Burst Pressure		Minimum Bend Radius		Weight of Hose	
	mm	in	mm	in	bar	psi	bar	psi	mm	in	Kg/m	lbs/ft
2580-4	4,8	0.19	13,2	0.52	70,0	1000	280,0	4000	76,2	3.00	0,18	0.12
2580-5	6,4	0.25	14,7	0.58	56,0	800	224,0	3200	85,9	3.38	0,22	0.15
2580-6	7,9	0.31	17,3	0.68	45,0	650	180,0	2600	101,6	4.00	0,25	0.17
2580-8	10,4	0.41	19,6	0.77	43,0	625	175,0	2500	117,3	4.62	0,28	0.19
2580-10	12,7	0.50	23,4	0.92	42,0	600	168,0	2400	139,7	5.50	0,42	0.28
2580-12	16,0	0.63	27,4	1.08	38,0	550	152,0	2200	165,1	6.50	0,51	0.34
2580-16	22,4	0.88	31,5	1.24	35,0	500	140,0	2000	187,5	7.38	0,54	0.36
2580-20	28,5	1.12	38,1	1.50	31,0	450	124,0	1800	228,6	9.00	0,64	0.43
2580-24	45,7	1.38	44,5	1.75	28,0	400	112,0	1600	266,7	10.50	0,76	0.51
2580-32	46,0	1.81	56,4	2.22	24,0	350	98,0	1400	336,6	13.25	1,12	0.75

Construction

Synthetic rubber tube, double textile braid reinforcement and synthetic rubber cover. For larger dash sizes, see Catalog A-MM-MC-0001-E.

Application

For water, gasoline, and fuel oil. For more information on specific fluid applications and high temperature ratings, see pages 349-355.

For Complete Agency Listings

See pages 346-348.

Fitting Reference Page

<i>Reusable</i>	
Fitting	136
Socket Data	65

Operating Temperature Range

-40°C to +100°C [-40°F to +212°F].

2583 Double textile braid

SAE 100R3



# Part Number	Hose I.D.		Hose O.D.		Maximum Operating Pressure		Minimum Burst Pressure		Minimum Bend Radius		Weight of Hose	
	mm	in	mm	in	bar	psi	bar	psi	mm	in	Kg/m	lbs/ft
2583-4	6,4	0.25	14,5	0.57	87,0	1250	350,0	5000	76,2	3.00	0,18	0.12
2583-6	9,7	0.38	19,1	0.75	78,0	1125	315,0	4500	101,6	4.00	0,33	0.22
2583-8	12,7	0.50	23,9	0.94	70,0	1000	280,0	4000	127,0	5.00	0,39	0.26
2583-12	19,1	0.75	31,8	1.25	52,0	750	210,0	3000	152,4	6.00	0,71	0.48
2583-16	25,4	1.00	38,1	1.50	39,0	565	157,0	2250	203,2	8.00	0,76	0.51
2583-20	31,8	1.25	44,5	1.75	26,0	375	105,0	1500	254,0	10.00	1,09	0.73

Construction

Synthetic rubber tube, double textile braid reinforcement and synthetic rubber cover.

Application

For hydraulics, fuel, lubricating oils, gasoline, air and water. Not approved for airbrake applications. For more information on specific fluid applications and high temperature ratings, see pages 349-355.

For Complete Agency Listings

See pages 346-348.

Fitting Reference Page

<i>Crimp</i>	
OTC	66

Operating Temperature Range

-40°C to +100°C [-40°F to +212°F]. Air not to exceed +71°C [+161°F].

FC211

Single wire braid

SAE 100R1AT



# Part Number	Hose I.D.		Hose O.D.		Maximum Operating Pressure		Minimum Burst Pressure		Minimum Bend Radius		Weight of Hose	
	mm	in	mm	in	bar	psi	bar	psi	mm	in	Kg/m	lbs/ft
FC211-04	6,4	0.25	13,5	0.53	192,0	2750	770,0	11000	100,0	4.00	0,22	0.15
FC211-06	9,7	0.38	17,5	0.69	157,0	2250	630,0	9000	125,0	5.00	0,36	0.24
FC211-08	12,7	0.50	20,6	0.81	140,0	2000	560,0	8000	180,0	7.00	0,43	0.29
FC211-12	19,1	0.75	27,7	1.09	87,0	1250	350,0	5000	241,3	9.50	0,68	0.46
FC211-16	25,4	1.00	35,8	1.41	70,0	1000	280,0	4000	304,8	12.00	1,19	0.80

Construction

Synthetic rubber tube, single wire braid reinforcement and synthetic rubber cover.

Operating Temperature Range

-40°C to +100°C [-40°F to +212°F]

Application

Hydraulic system service with petroleum and water-base fluids, for general industrial service. For more information on specific fluid applications and high temperature ratings, see pages 349-355.

For Complete Agency Listings

See pages 346-348.

Fitting Reference Page

Crimp	
TTC	66
Skive Nipple	66
Socket Data	64
Reusable	
Fitting	148
Socket Data	65

2681

HI-IMPULSE®

Single wire braid

Meets or exceeds:

SAE 100R1A, EN853 1ST, ISO 1436-1 Type 1ST



# Part Number	Hose I.D.		Hose O.D.		Maximum Operating Pressure		Minimum Burst Pressure		Minimum Bend Radius		Weight of Hose	
	mm	in	mm	in	bar	psi	bar	psi	mm	in	Kg/m	lbs/ft
2681-3	4,8	0.19	12,7	0.50	280,0	4000	1120,0	16000	88,9	3.50	0,19	0.13
2681-4	6,4	0.25	15,8	0.62	227,0	3250	897,0	13000	100,0	4.00	0,28	0.19
2681-5	7,9	0.31	17,5	0.69	227,0	3250	897,0	13000	115,0	4.50	0,40	0.27
2681-6	9,7	0.38	19,8	0.78	210,0	3000	840,0	12000	125,0	5.00	0,45	0.30
2681-8	12,7	0.50	23,1	0.91	175,0	2500	700,0	10000	180,0	7.00	0,58	0.39
2681-10	16,0	0.63	26,2	1.03	140,0	2000	560,0	8000	200,0	8.00	0,68	0.46
2681-12	19,1	0.75	30,2	1.19	124,0	1800	497,0	7200	240,0	9.50	0,79	0.53
2681-16	25,4	1.00	38,1	1.50	90,0	1300	359,0	5200	300,0	12.00	1,19	0.80
2681-20	31,8	1.25	46,0	1.81	60,0	900	248,0	3600	420,0	16.50	1,46	0.98
2681-24	38,1	1.50	52,3	2.06	49,0	700	193,0	2800	500,0	20.00	1,67	1.12
2681-32	50,8	2.00	65,5	2.58	42,0	600	168,0	2400	630,0	25.00	2,43	1.63

Construction

Synthetic rubber tube, single wire braid reinforcement and synthetic rubber cover.

Operating Temperature Range

-40°C to +100°C [-40°F to +212°F]

Application

Hydraulic system service with petroleum and water-base fluids, for general industrial service. For more information on specific fluid applications and high temperature ratings, see pages 349-355.

For Complete Agency Listings

See pages 346-348.

Fitting Reference Page

Crimp	
Skive Nipple	66
Socket Data	64

GH663 MATCHMATE Plus HI-IMPULSE Single wire braid



Meets or exceeds:
SAE 100R1AT Type S, EN853 1SN, ISO 1436-1 Type 1SN

# Part Number	Hose I.D.		Hose O.D.		Maximum Operating Pressure		Minimum Burst Pressure		Minimum Bend Radius		Weight of Hose	
	mm	in	mm	in	bar	psi	bar	psi	mm	in	Kg/m	lbs/ft
GH663-4	6,4	0.25	13,5	0.53	227,0 192,0	3250† 2750	897,0 770,0	13000† 11000	100,0	4.00	0,24	0.16
GH663-6	9,7	0.38	17,5	0.69	210,0 157,0	3000† 2250	840,0 630,0	12000† 9000	125,0	5.00	0,37	0.25
GH663-8	12,7	0.50	20,6	0.81	175,0 140,0	2500† 2000	700,0 560,0	10000† 8000	180,0	7.00	0,45	0.30
GH663-12	19,1	0.75	27,7	1.09	124,0 87,0	1800† 1250	497,0 350,0	7200† 5000	241,3	9.50	0,67	0.45
GH663-16	25,4	1.00	35,8	1.41	90,0 70,0	1300† 1000	359,0 280,0	5200† 4000	304,8	12.00	1,01	0.68
GH663-20	31,8	1.25	43,4	1.71	66,0	950	260,0	3770	419,1	16.50	1,31	0.88
GH663-24	38,1	1.50	50,6	1.99	50,0	725	200,0	2900	508,0	20.00	1,56	1.05
GH663-32	50,8	2.00	64,0	2.52	40,0	580	160,0	2320	635,0	25.00	1,95	1.31

Construction

Synthetic rubber tube, single wire braid reinforcement and synthetic rubber cover.

Operating Temperature Range

-40°C to +100°C [-40°F to +212°F]

Application

Hydraulic system service with petroleum and water-base fluids, for general industrial service. For more information on specific fluid applications and high temperature ratings, see pages 349-355.

For Complete Agency Listings

See pages 346-348.

† Improved performance when used with Global Crimp fittings.

Fitting Reference Page

<i>Crimp</i>	
TTC	66
Skive Nipple	66
Socket Data	64
<i>Reusable</i>	
Fitting	148
Socket Data	65

GH194 AQP MATCHMATE BLUE HI-IMPULSE Single wire braid



Meets or exceeds:
SAE 100R1AT Type S, EN853 1SN, ISO 1436-1 Type 1SN

# Part Number	Hose I.D.		Hose O.D.		Maximum Operating Pressure		Minimum Burst Pressure		Minimum Bend Radius		Weight of Hose	
	mm	in	mm	in	bar	psi	bar	psi	mm	in	Kg/m	lbs/ft
GH194-4	6,4	0.25	13,5	0.53	227,0	3250	897,0	13000	100,0	4.00	0,25	0.17
GH194-6	9,7	0.38	17,5	0.69	210,0	3000	840,0	12000	125,0	5.00	0,37	0.25
GH194-8	12,7	0.50	20,6	0.81	175,0	2500	700,0	10000	180,0	7.00	0,45	0.30
GH194-10	16,0	0.63	23,9	0.94	140,0	2000	560,0	8000	205,0	8.00	0,54	0.36
GH194-12	19,1	0.75	27,7	1.09	124,0	1800	497,0	7200	240,0	9.50	0,68	0.46
GH194-16	25,4	1.00	35,8	1.41	90,0	1300	359,0	5200	300,0	12.00	0,98	0.66
GH194-20	31,8	1.25	43,9	1.73	62,0	900	248,0	3600	420,0	16.50	1,26	0.85

Construction

AQP elastomer tube, single wire braid reinforcement and blue AQP elastomer cover.

Operating Temperature Range

-40°C to +150°C [-40°F to +300°F].

Application

Petroleum and fire-resistant hydraulic fluids, fuel and lubricating oils, gasoline, water and other industrial fluids. For more information on specific fluid applications and high temperature ratings, see pages 349-355.

For Complete Agency Listings

See pages 346-348.

Fitting Reference Page

<i>Crimp</i>	
TTC	66
Skive Nipple	66
Socket Data	64

FC194 AQP HI-IMPULSE Single wire braid



Meets or exceeds:
SAE 100R1A, EN853 1ST, ISO 1436-1 Type 1ST

# Part Number	Hose I.D.		Hose O.D.		Maximum Operating Pressure		Minimum Burst Pressure		Minimum Bend Radius		Weight of Hose	
	mm	in	mm	in	bar	psi	bar	psi	mm	in	Kg/m	lbs/ft
FC194-04	6,4	0.25	16,0	0.63	227,0	3250	897,0	13000	100,0	4.00	0,28	0.19
FC194-06	9,7	0.38	19,8	0.78	210,0	3000	840,0	12000	125,0	5.00	0,45	0.30
FC194-08	12,7	0.50	22,9	0.90	175,0	2500	700,0	10000	180,0	7.00	0,58	0.39
FC194-10	16,0	0.63	26,2	1.03	140,0	2000	560,0	8000	200,0	8.00	0,68	0.46
FC194-12	19,1	0.75	30,2	1.19	124,0	1800	497,0	7200	240,0	9.50	0,79	0.53
FC194-16	25,4	1.00	38,1	1.50	90,0	1300	359,0	5200	300,0	12.00	1,19	0.80
FC194-20	31,8	1.25	46,0	1.81	62,0	900	248,0	3600	420,0	16.50	1,46	0.98

Construction

AQP elastomer tube, single wire braid reinforcement and blue AQP elastomer cover.

Application

Petroleum and fire-resistant hydraulic fluids, fuel, lubricating oils, gasoline, water, and other industrial fluids. For more information on specific fluid applications and high temperature ratings, see pages 349-355.

For Complete Agency Listings

See pages 346-348.

Fitting Reference Page

Crimp	Page
Skive Nipple	66
Socket Data	64

Operating Temperature Range

-40°C to +150°C [-40°F to +300°F]

FC611 EPDM hose Single wire braid



# Part Number	Hose I.D.		Hose O.D.		Maximum Operating Pressure		Minimum Burst Pressure		Minimum Bend Radius		Weight of Hose	
	mm	in	mm	in	bar	psi	bar	psi	mm	in	Kg/m	lbs/ft
FC611-04	6,4	0.25	13,5	0.53	210,0	3000	840,0	12000	101,6	4.00	0,24	0.16
FC611-06	9,7	0.38	17,3	0.68	157,0	2250	630,0	9000	127,0	5.00	0,33	0.22
FC611-08	12,7	0.50	20,3	0.80	140,0	2000	560,0	8000	177,8	7.00	0,42	0.28
FC611-12	19,1	0.75	27,9	1.10	87,0	1250	350,0	5000	241,3	9.50	0,64	0.43
FC611-16	25,4	1.00	35,8	1.41	70,0	1000	280,0	4000	304,8	12.00	0,89	0.60
FC611-20	31,8	1.25	43,4	1.71	43,0	625	175,0	2500	419,1	16.50	1,19	0.80
FC611-24	38,1	1.50	50,5	1.99	35,0	500	140,0	2000	508,0	20.00	1,52	1.02
FC611-32	50,8	2.00	64,0	2.52	26,0	375	105,0	1500	635,0	25.00	1,90	1.28

Construction

Synthetic EPDM tube, single wire braid reinforcement and green EPDM synthetic cover.

Application

Ground support equipment (GSE), industrial phosphate ester-based fluids, water glycol systems. For more information on specific fluid applications and high temperature ratings, see pages 349-355.

For Complete Agency Listings

See pages 346-348.

Fitting Reference Page

Crimp	Page
TTC	66

Operating Temperature Range

-40°C to +75°C [-40°F to +175°F]

FC310 Hi-Pac wire braid

SAE 100R16 performance



# Part Number	Hose I.D.		Hose O.D.		Maximum Operating Pressure		Minimum Burst Pressure		Minimum Bend Radius		Weight of Hose	
	mm	in	mm	in	bar	psi	bar	psi	mm	in	Kg/m	lbs/ft
FC310-04	6,4	0.25	14,0	0.55	350,0	5000.00	1400,0	20000	50,8 76,2	2.00† 3.00	0,31	0.21
FC310-06	9,7	0.38	17,3	0.68	280,0	4000.00	1120,0	16000	63,5 88,9	2.50† 3.50	0,40	0.27
FC310-08	12,7	0.50	20,1	0.79	245,0	3500.00	980,0	14000	88,9 127,0	3.50† 5.00	0,51	0.34
FC310-10	16,0	0.63	23,6	0.93	192,0	2750.00	770,0	11000	101,6 152,4	4.00† 6.00	0,65	0.44
FC310-12	19,1	0.75	27,4	1.08	157,0	2250.00	630,0	9000	120,7 177,8	4.75† 7.00	0,74	0.50
FC310-16	25,4	1.00	34,6	1.36	140,0	2000.00	560,0	8000	152,4 228,6	6.00† 9.00	1,06	0.71
FC310-20	31,8	1.25	42,9	1.69	113,0	1625.00	455,0	6500	209,6 279,4	8.25† 11.00	1,58	1.06

Construction

Synthetic rubber tube, HI-PAC braided wire reinforcement, synthetic rubber cover.

Operating Temperature Range

-40°C to +100°C [-40°F to +212°F]

Application

Hydraulic system service with petroleum and water-base fluids, for general industrial service. For more specific information on fluid applications, see pages 349-355.

For Complete Agency Listings

See pages 397-398.

† Improved minimum bend radius when used with global fittings.

Fitting Reference Page

<i>Crimp</i>	
TTC	66
Skive Nipple	66
Socket Data	64
<i>Reusable</i>	
Fitting	151
Socket Data	65

FC510 AQP Hi-Pac wire braid



# Part Number	Hose I.D.		Hose O.D.		Maximum Operating Pressure		Minimum Burst Pressure		Minimum Bend Radius		Weight of Hose	
	mm	in	mm	in	bar	psi	bar	psi	mm	in	Kg/m	lbs/ft
FC510-04	6,4	0.25	14,5	0.57	350,0	5000	1400,0	20000	76,2	3.00	0,34	0.23
FC510-06	9,7	0.38	17,5	0.69	280,0	4000	1120,0	16000	88,9	3.50	0,43	0.29
FC510-08	12,7	0.50	20,3	0.80	245,0	3500	980,0	14000	127,0	5.00	0,51	0.34
FC510-10	16,0	0.63	23,6	0.93	192,0	2750	770,0	11000	152,4	6.00	0,65	0.44
FC510-12	19,1	0.75	27,7	1.09	157,0	2250	630,0	9000	177,8	7.00	0,77	0.52
FC510-16	25,4	1.00	34,8	1.37	140,0	2000	560,0	8000	228,6	9.00	1,06	0.71
FC510-20	31,8	1.25	43,2	1.70	113,0	1625	455,0	6500	279,4	11.00	1,61	1.08

Construction

AQP elastomer tube, HI-PAC braided wire reinforcement and blue AQP elastomer cover.

Operating Temperature Range

-40°C to +150°C [-40°F to +300°F]

Application

Petroleum and fire-resistant hydraulic fluids, fuel, and lubricating systems. For more information on specific fluid applications and high temperature ratings, see pages 349-355.

For Complete Agency Listings

See pages 397-398.

Fitting Reference Page

<i>Crimp</i>	
TTC	66
Skive Nipple	66
Socket Data	64
<i>Reusable</i>	
Fitting	151
Socket Data	65

FC639

Flexible cover

3000 PSI Constant pressure

SAE 100R17



# Part Number	Hose I.D.		Hose O.D.		Maximum Operating Pressure		Minimum Burst Pressure		Minimum Bend Radius		Weight of Hose	
	mm	in	mm	in	bar	psi	bar	psi	mm	in	Kg/m	lbs/ft
FC639-04	6,4	0.25	13,2	0.52	210,0	3000	840,0	12000	50,8	2.00	0,22	0.15
FC639-06	9,7	0.38	17,0	0.67	210,0	3000	840,0	12000	63,5	2.50	0,34	0.23
FC639-08	12,7	0.50	20,6	0.81	210,0	3000	840,0	12000	88,9	3.50	0,48	0.32
FC639-10**	16,0	0.63	25,4	1.00	210,0	3000	840,0	12000	101,6	4.00	0,76	0.51
FC639-12**	19,1	0.75	29,0	1.14	210,0	3000	840,0	12000	120,7	4.75	0,94	0.63
FC639-16**	25,4	1.00	36,3	1.43	210,0	3000	840,0	12000	152,4	6.00	1,24	0.83

Construction

Synthetic rubber tube with one or two wire braid reinforcements, ozone flexible neoprene rubber cover.

Operating Temperature Range

-40°C to +100°C [-40°F to +212°F]

Application

General industrial and hydraulic system service with petroleum and water-base fluids. Recommended for high-pressure oil lines used on construction equipment and other off-highway applications. For more information on specific fluid applications and high temperature ratings, see pages 349-355.

For Complete Agency Listings

See pages 346-348.

**Two braids of high tensile wire.

Fitting Reference Page

Crimp	Page
TTC	66
Skive Nipple	66
Socket Data	64

GH681

3000 PSI Constant pressure

Single wire braid

Exceeds EN 853 Type 1



# Part Number	Hose I.D.		Hose O.D.		Maximum Operating Pressure		Minimum Burst Pressure		Minimum Bend Radius		Weight of Hose	
	mm	in	mm	in	bar	psi	bar	psi	mm	in	Kg/m	lbs/ft
GH681-4	6,4	0.25	11,9	0.47	210,0	3000	840,0	12000	50,8	2.00	0,16	0.11
GH681-6	9,7	0.38	16,0	0.63	210,0	3000	840,0	12000	63,5	2.50	0,28	0.18
GH681-8	12,7	0.50	19,8	0.78	210,0	3000	840,0	12000	88,9	3.50	0,39	0.26

Construction

Synthetic rubber tube, single wire braid reinforcement and synthetic rubber cover. Meets or exceeds EN requirements at 1/2 SAE Bend Radius.

Operating Temperature Range

-40°C to +100°C [-40°F to +212°F]

Application

Hydraulic system service with petroleum and water-base fluids, for general industrial service. For more information on specific fluid applications and high temperature ratings, see pages 349-355.

For Complete Agency Listings

See pages 346-348.

Fitting Reference Page

Crimp	Page
TTC (-6 only)	66
Skive Nipple	66
Socket Data	64

FC839B BRUISER

Ultra-abrasion resistant cover

3000 PSI Constant pressure

SAE 100R17



# Part Number	Hose I.D.		Hose O.D.		Maximum Operating Pressure		Minimum Burst Pressure		Minimum Bend Radius		Weight of Hose	
	mm	in	mm	in	bar	psi	bar	psi	mm	in	Kg/m	lbs/ft
FC839B-04	6,4	0.25	13,2	0.52	210,0	3000	840,0	12000	50,8	2.00	0,22	0.15
FC839B-06	9,7	0.38	17,0	0.67	210,0	3000	840,0	12000	63,5	2.50	0,34	0.23
FC839B-08	12,7	0.50	20,6	0.81	210,0	3000	840,0	12000	88,9	3.50	0,48	0.32
FC839B-10**	16,0	0.63	25,4	1.00	210,0	3000	840,0	12000	101,6	4.00	0,76	0.51
FC839B-12**	19,1	0.75	29,0	1.14	210,0	3000	840,0	12000	120,7	4.75	0,94	0.63
FC839B-16**	25,4	1.00	36,3	1.43	210,0	3000	840,0	12000	152,4	6.00	1,24	0.83

Construction

Synthetic rubber tube with one or two layers of braided wire reinforcement, synthetic rubber intermediate cover and BRUISER outer cover.

Operating Temperature Range

-40°C to +100°C [-40°F to +212°F]

Application

High abrasion industrial and hydraulic system applications with petroleum and water-based fluids. Recommended for use on critical applications in construction, forestry, and other off-highway vehicles. BRUISER outer cover offers unmatched abrasion, chemical, and environmental protection. For more information on specific fluid applications and temperature ratings, see pages 349-355.

For Complete Agency Listings

See pages 346-348.

**Two braids of high tensile wire.

Fitting Reference Page

Crimp	Page
TTC	66
Skive Nipple	66
Socket Data	64

FC849

4000 PSI Constant pressure



# Part Number	Hose I.D.		Hose O.D.		Maximum Operating Pressure		Minimum Burst Pressure		Minimum Bend Radius		Weight of Hose	
	mm	in	mm	in	bar	psi	bar	psi	mm	in	Kg/m	lbs/ft
FC849-04	6,4	0.25	15,2	0.60	280,0	4000	1120,0	16000	50,8	2.00	0,36	0.24
FC849-06	9,7	0.38	19,3	0.76	280,0	4000	1120,0	16000	63,5	2.50	0,54	0.36
FC849-08	12,7	0.50	22,6	0.89	280,0	4000	1120,0	16000	88,9	3.50	0,64	0.43
FC849-10	16,0	0.63	25,7	1.01	280,0	4000	1120,0	16000	101,6	4.00	0,90	0.60
FC849-12	19,1	0.75	30,0	1.18	280,0	4000	1120,0	16000	120,7	4.75	1,07	0.72

Construction

Synthetic rubber tube with two layers of wire braid reinforcement and abrasion resistance synthetic rubber cover.

Operating Temperature Range

-40°C to +100°C [-40°F to +212°F]

Application

Industrial and hydraulic system applications with petroleum and water-based fluids. Recommended for use on construction, forestry, and other off-highway vehicles. For more information on specific fluid applications and temperature ratings, see pages 349-355.

For Complete Agency Listings

See pages 346-348.

Fitting Reference Page

Crimp	Page
TTC	66
Skive Nipple *	66
Socket Data	64

*-06 thru -12 only

FC849B BRUISER

Ultra-abrasion resistant cover

4000 PSI Constant Pressure



# Part Number	Hose I.D.		Hose O.D.		Maximum Operating Pressure		Minimum Burst Pressure		Minimum Bend Radius		Weight of Hose	
	mm	in	mm	in	bar	psi	bar	psi	mm	in	Kg/m	lbs/ft
FC849B-04	6,4	0.25	15,2	0.60	280,0	4000	1120,0	16000	50,8	2.00	0,36	0.24
FC849B-06	9,7	0.38	19,3	0.76	280,0	4000	1120,0	16000	63,5	2.50	0,54	0.36
FC849B-08	12,7	0.50	22,6	0.89	280,0	4000	1120,0	16000	88,9	3.50	0,64	0.43
FC849B-10	16,0	0.63	25,7	1.01	280,0	4000	1120,0	16000	101,6	4.00	0,90	0.60
FC849B-12	19,1	0.75	30,0	1.18	280,0	4000	1120,0	16000	120,7	4.75	1,07	0.72

Construction

Synthetic rubber tube with two layers of wire braid reinforcement, synthetic rubber intermediate cover and BRUISER outer cover.

Operating Temperature Range

-40°C to +100°C [-40°F to +212°F]

Application

High abrasion industrial and hydraulic system applications with petroleum and water-based fluids. Recommended for use on critical applications in construction, forestry, and other off-highway vehicles. BRUISER outer cover offers unmatched abrasion, chemical, and environmental protection. For more information on specific fluid applications and temperature ratings, see pages 349-355.

For Complete Agency Listings

See pages 346-348.

Fitting Reference Page

Crimp	
TTC	66
Skive Nipple*	66
Socket Data	64

*-06 thru -12 only

FC212

Double wire braid

SAE 100R2AT



# Part Number	Hose I.D.		Hose O.D.		Maximum Operating Pressure		Minimum Burst Pressure		Minimum Bend Radius		Weight of Hose	
	mm	in	mm	in	bar	psi	bar	psi	mm	in	Kg/m	lbs/ft
FC212-04	6,4	0.25	15,2	0.60	350,0	5000	1400,0	20000	101,6	4.00	0,40	0.27
FC212-06	9,7	0.38	19,1	0.75	280,0	4000	1120,0	16000	127,0	5.00	0,57	0.38
FC212-08	12,7	0.50	22,4	0.88	245,0	3500	980,0	14000	177,8	7.00	0,68	0.46
FC212-12	19,1	0.75	29,5	1.16	157,0	2250	630,0	9000	241,3	9.50	0,98	0.66
FC212-16	25,4	1.00	38,1	1.50	140,0	2000	560,0	8000	304,8	12.00	1,49	1.00
FC212-20	31,8	1.25	48,0	1.89	113,0	1625	455,0	6500	419,1	16.50	2,25	1.51
FC212-24	38,1	1.50	54,6	2.15	87,0	1250	350,0	5000	508,0	20.00	2,60	1.75
FC212-32	50,8	2.00	63,8	2.51	78,0	1125	315,0	4500	635,0	25.00	3,35	2.25

Construction

Synthetic rubber tube, double wire braid reinforcement and synthetic rubber cover.

Operating Temperature Range

-40°C to +100°C [-40°F to +212°F]

Application

Hydraulic system service with petroleum and water-base fluids, for general industrial service. For more information on specific fluid applications and high temperature ratings, see pages 349-355.

For Complete Agency Listings

See pages 346-348.

Fitting Reference Page

Crimp	
TTC	66
Skive Nipple	66
Socket Data	64
Reusable	
Fitting	165
Socket Data	65

GH120 MATCHMATE ICE Cold temperature applications

SAE 100R16 performance



# Part Number	Hose I.D.		Hose O.D.		Maximum Operating Pressure		Minimum Burst Pressure		Minimum Bend Radius		Weight of Hose	
	mm	in	mm	in	bar	psi	bar	psi	mm	in	Kg/m	lbs/ft
GH120-4	6,4	0.25	14,2	0.56	350,0	5000	1400,0	20000	50,8	2.00	0,30	0.20
GH120-6	9,7	0.38	17,3	0.68	280,0	4000	1120,0	16000	63,5	2.50	0,40	0.27
GH120-8	12,7	0.50	20,8	0.82	245,0	3500	980,0	14000	88,9	3.50	0,58	0.39
GH120-10	16,0	0.63	24,9	0.98	192,0	2750	770,0	11000	101,6	4.00	0,74	0.50
GH120-12	19,1	0.75	28,4	1.12	157,0	2250	630,0	9000	120,7	4.75	0,92	0.62
GH120-16	25,4	1.00	35,8	1.41	140,0	2000	560,0	8000	152,4	6.00	1,22	0.82
GH120-20	31,8	1.25	43,4	1.71	113,0	1625	455,0	6500	209,6	8.25	1,60	1.07
GH120-24	38,1	1.50	51,6	2.03	87,0	1250	350,0	5000	254,0	10.00	2,11	1.42
GH120-32	50,8	2.00	63,8	2.51	78,0	1125	315,0	4500	317,5	12.50	2,80	1.88

Construction

Aeroquip brand exclusive low temperature compound tube and cover, double wire braid reinforcement.

Operating Temperature Range

-57°C to +100°C [-70°F to +212°F]

Application

Low temperature flexing and hydraulic system service with petroleum and water-base fluids. For use in frigid environments on construction equipment and other mobile applications. For more information on specific fluid applications and high temperature ratings, see pages 349-355.

For Complete Agency Listings

See pages 346-348.

Fitting Reference

Fitting Reference	Page
<i>Crimp</i>	
TTC	66
Skive Nipple *	66
Socket Data	64

*-04 thru -20 only

2766 Double wire braid

MIL-DTL-13531, Type II, Class A



# Part Number	Hose I.D.		Hose O.D.		Maximum Operating Pressure		Minimum Burst Pressure		Minimum Bend Radius		Weight of Hose	
	mm	in.	mm	in.	bar	psi	bar	psi	mm	in.	Kg/m	lbs/ft
2766-4	6,4	0.25	17,5	0.69	350,0	5000	1400,0	20000	101,6	4.00	0,47	0.32
2766-6	9,7	0.38	21,3	0.84	280,0	4000	1120,0	16000	127,0	5.00	0,68	0.46
2766-8	12,7	0.50	24,6	0.97	245,0	3500	980,0	14000	177,8	7.00	0,80	0.54
2766-12	19,1	0.75	31,8	1.25	157,0	2250	630,0	9000	241,3	9.50	1,11	0.75
2766-16	25,4	1.00	39,6	1.56	140,0	2000	560,0	8000	279,4	11.00	1,51	1.02
2766-20	31,8	1.25	50,8	2.00	113,0	1625	455,0	6500	406,4	16.00	2,41	1.63
2766-24	38,1	1.50	57,2	2.25	87,0	1250	350,0	5000	508,0	20.00	2,42	1.64
2766-32	50,8	2.00	69,9	2.75	78,0	1000	315,0	4500	558,8	22.00	3,97	2.69

Construction

Synthetic rubber tube, double wire braid reinforcement and synthetic rubber cover.

Operating Temperature Range

-54°C to +93°C [-65°F to +200°F]

Application

High pressure hydraulics, fuel and lubricating oil and gasoline. For more information specific fluid applications and high temperature ratings, see pages 349-355.

For Complete Agency Listings

See pages 346-348.

Fitting Reference

Fitting Reference	Page
<i>Crimp</i>	
Skive Nipple	66
Socket Data	64
<i>Reusable</i>	
Fitting	156
Socket Data	65

FC693

EPDM hose

Double wire braided high pressure



# Part Number	Hose I.D.		Hose O.D.		Maximum Operating Pressure		Minimum Burst Pressure		Minimum Bend Radius		Weight of Hose	
	mm	in	mm	in	bar	psi	bar	psi	mm	in	Kg/m	lbs/ft
FC693-04	6,4	0.25	15,2	0.60	350,0	5000	1400,0	20000	101,6	4.00	0,37	0.25
FC693-06	9,7	0.38	19,1	0.75	280,0	4000	1120,0	16000	127,0	5.00	0,54	0.36
FC693-08	12,7	0.50	22,1	0.87	245,0	3500	980,0	14000	177,8	7.00	0,60	0.40

Construction

Synthetic EPDM tube, double wire braid reinforcement and green EPDM synthetic cover.

Operating Temperature Range

-40°C to +75°C [-40°F to +175°F]

Application

Ground support equipment (GSE), industrial phosphate ester-based fluids, water glycol systems. For more information on specific fluid applications and high temperature ratings, see pages 349-355.

For Complete Agency Listings

See pages 346-348.

Fitting Reference Page

Crimp	
TTC	66

FC735 BRUISER

Ultra-abrasion resistant cover

Double wire braid



Meets or exceeds:

SAE 100R16 Type S, EN 857 2SC, ISO 11237-1 Type 2SC

# Part Number	Hose I.D.		Hose O.D.		Maximum Operating Pressure		Minimum Burst Pressure		Minimum Bend Radius		Weight of Hose	
	mm	in	mm	in	bar	psi	bar	psi	mm	in	Kg/m	lbs/ft
FC735-04*	6,4	0.25	13,5	0.53	350,0	5000*	1400,0	20000*	50,8	2.00	0,33	0.22
FC735-06	9,7	0.38	17,5	0.69	350,0	5000	1400,0	20000	63,5	2.50	0,43	0.29
FC735-08	12,7	0.50	20,6	0.81	297,0	4250	1190,0	17000	88,9	3.50	0,58	0.39
FC735-10	16,0	0.63	23,6	0.93	250,0	3625	1000,0	14500	101,6	4.00	0,65	0.44
FC735-12	19,1	0.75	27,9	1.10	216,0	3125	870,0	12500	120,7	4.75	0,79	0.53
FC735-16	25,4	1.00	36,1	1.42	175,0	2500	700,0	10000	152,4	6.00	1,07	0.72
FC735-20	31,8	1.25	43,2	1.70	157,0	2250	630,0	9000	209,6	8.25	1,62	1.09

Construction

Synthetic rubber tube, double wire braid reinforcement, synthetic rubber intermediate cover, and BRUISER outer cover. Meets or exceeds EN requirements at 1/2 SAE bend radius.

Operating Temperature Range

-40°C to +100°C [-40°F to +212°F]

Application

High abrasion applications. Hydraulic system service with petroleum and water-base fluids, for general industrial service. For more information on specific fluid applications and high temperature ratings, see pages 349-355.

*Meets SAE100R2 pressures.

For Complete Agency Listings

See pages 346-348.

Fitting Reference Page

Crimp	
TTC	66
Skive Nipple	66
Socket Data	64

2781 HI-IMPULSE Double wire braid



Meets or exceeds:
SAE 100R2A, EN853 2ST, ISO 1436-1 Type 2ST

# Part Number	Hose I.D.		Hose O.D.		Maximum Operating Pressure		Minimum Burst Pressure		Minimum Bend Radius		Weight of Hose	
	mm	in	mm	in	bar	psi	bar	psi	mm	in	Kg/m	lbs/ft
2781-4	6,4	0.25	17,5	0.69	400,0 350,0	5800† 5000	1600,0 1400	23200† 20000	101,6	4.00	0,50	0.33
2781-6	9,7	0.38	21,3	0.84	350,0 280,0	5000† 4000	1400,0 1120,0	20000† 16000	127,0	5.00	0,67	0.45
2781-8	12,7	0.50	24,6	0.97	297,0 245,0	4250† 3500	1190,0 980,0	17000† 14000	177,8	7.00	0,83	0.56
2781-10	16,0	0.63	27,7	1.09	250,0 227,0	3625† 3250	1000,0 770,0	14500† 11000	203,2	8.00	0,97	0.62
2781-12	19,1	0.75	31,8	1.25	216,0 210,0	3125† 3000	870,0 630,0	12500† 9000	241,3	9.50	1,19	0.80
2781-16	25,4	1.00	39,6	1.56	175,0 140,0	2500† 2000	700,0 560,0	10000† 8000	304,8	12.00	1,58	1.06
2781-20	31,8	1.25	50,8	2.00	157,0 113,0	2250† 1625	630,0 455,0	9000† 6500	419,1	16.50	2,57	1.73
2781-24	38,1	1.50	57,2	2.25	124,0 122,0	1800† 1750	497,0 350,0	7200† 5000	508,0	20.00	3,05	2.05
2781-32	50,8	2.00	69,9	2.75	105,0 87,0	1500† 1250	420,0 315,0	6000† 4500	635,0	25.00	4,02	2.70

Construction

Synthetic rubber tube, double wire braid reinforcement and synthetic rubber cover.

Operating Temperature Range
-40°C to +100°C [-40°F to +212°F]

Application

Hydraulic system service with petroleum and water-base fluids, for general industrial service. For more information on specific fluid applications and high temperature ratings, see pages 349-355.

For Complete Agency Listings

See pages 346-348.

Improved pressure performance when used with global fittings.

Fitting Reference Page

<i>Crimp</i>	
Skive Nipple	66
Socket Data	64
<i>Reusable</i>	
Fitting	156
Socket Data	65

GH781 MATCHMATE Plus HI-IMPULSE Double wire braid



Meets or exceeds:
SAE 100R16 Type S, EN857 2SC, ISO 11237-1 Type 2SC

# Part Number	Hose I.D.		Hose O.D.		Maximum Operating Pressure		Minimum Burst Pressure		Minimum Bend Radius		Weight of Hose	
	mm	in	mm	in	bar	psi	bar	psi	mm	in	Kg/m	lbs/ft
GH781-4	6,4	0.25	13,5	0.53	400,0	5800	1600,0	23200	50,8	2.00	0,33	0.22
GH781-6	9,7	0.38	17,5	0.69	350,0	5000	1400,0	20000	63,5	2.50	0,43	0.29
GH781-8	12,7	0.50	20,6	0.81	297,0	4250	1190,0	17000	88,9	3.50	0,58	0.39
GH781-10	16,0	0.63	23,6	0.93	250,0	3625	1000,0	14500	101,6	4.00	0,65	0.44
GH781-12	19,1	0.75	27,9	1.10	216,0	3125	870,0	12500	120,7	4.75	0,79	0.53
GH781-16	25,4	1.00	36,1	1.42	175,0	2500	700,0	10000	152,4	6.00	1,07	0.72
GH781-20	31,8	1.25	41,9	1.65	157,0	2250	630,0	9000	209,6	8.25	1,62	1.09
GH781-24	38,1	1.50	51,6	2.03	124,0	1800	497,0	7200	254,0	10.00	2,08	1.40
GH781-32	50,8	2.00	64,3	2.53	90,0	1300	359,0	5200	317,5	12.50	2,83	1.90

Construction

Synthetic rubber tube, double wire braid reinforcement and synthetic rubber cover. Meets or exceeds EN requirements at 1/2 SAE Bend Radius.

Operating Temperature Range
-40°C to +100°C [-40°F to +212°F]

Application

Hydraulic system service with petroleum and water-base fluids, for general industrial service. For more information on specific fluid applications and high temperature ratings, see pages 349-355.

For Complete Agency Listings

See pages 346-348.

Fitting Reference Page

<i>Crimp</i>	
TTC	66
Skive Nipple *	66
Socket Data	64

*-04 thru -20 only

GH793 MATCHMATE Plus HI-IMPULSE Double wire braid

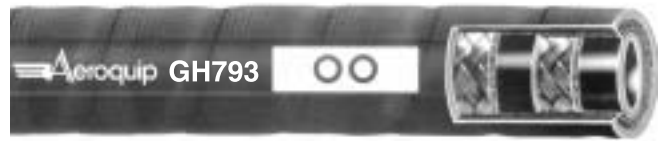

Meets or exceeds:

SAE 100R2AT Type S, EN853 2SN, ISO 1436-1 Type 2SN

# Part Number	Hose I.D.		Hose O.D.		Maximum Operating Pressure		Minimum Burst Pressure		Minimum Bend Radius		Weight of Hose	
	mm	in	mm	in	bar	psi	bar	psi	mm	in	Kg/m	lbs/ft
GH793-4	6,4	0.25	15,2	0.60	400,0 350,0	5800† 5000	1600,0 1400,0	23200† 20000	101,6	4.00	0,39	0.26
GH793-6	9,7	0.38	19,1	0.75	350,0 280,0	5000† 4000	1400,0 1120,0	20000† 16000	127,0	5.00	0,57	0.38
GH793-8	12,7	0.50	22,1	0.87	297,0 245,0	4250† 3500	1190,0 980,0	17000† 14000	177,8	7.00	0,68	0.46
GH793-10	16,0	0.63	24,9	0.98	250,0 192,0	3625† 2750	1000,0 770,0	14500† 11000	203,2	8.00	0,80	0.54
GH793-12	19,1	0.75	29,5	1.16	216,0 157,0	3125† 2250	870,0 630,0	12500† 9000	241,3	9.50	0,98	0.66
GH793-16	25,4	1.00	38,1	1.50	175,0 140,0	2500† 2000	700,0 560,0	10000† 8000	304,8	12.00	1,50	1.01
GH793-20	31,8	1.25	48,8	1.92	157,0	2250	630,0	9000	419,1	16.50	2,29	1.54
GH793-24	38,1	1.50	54,6	2.15	124,0	1800	497,0	7200	508,0	20.00	2,50	1.68
GH793-32	50,8	2.00	63,8	2.51	90,0	1300	359,0	5200	635,0	25.00	3,30	2.22

Construction

Synthetic rubber tube, double wire braid reinforcement and synthetic rubber cover.

Operating Temperature Range

-40°C to +100°C [-40°F to +212°F]

Application

Hydraulic system service with petroleum and water-base fluids, for general industrial service. For more information on specific fluid applications and high temperature ratings, see pages 349-355.

For Complete Agency Listings

See pages 346-348.

Improved pressure performance when used with global fittings.

Fitting Reference Page

<i>Crimp</i>	
TTC	66
Skive Nipple	66
Socket Data	64
<i>Reusable</i>	
Fitting	165
Socket Data	65

GH195 AQP MATCHMATE BLUE HI-IMPULSE Double wire braid



Meets or exceeds:

SAE 100R2AT Type S, EN853 2SN ISO 1436-1 Type 2SN

# Part Number	Hose I.D.		Hose O.D.		Maximum Operating Pressure		Minimum Burst Pressure		Minimum Bend Radius		Weight of Hose	
	mm	in	mm	in	bar	psi	bar	psi	mm	in	Kg/m	lbs/ft
GH195-4	6,4	0.25	15,2	0.60	400,0	5800	1600,0	23200	101,6	4.00	0,40	0.27
GH195-6	9,7	0.38	19,1	0.75	350,0	5000	1400,0	20000	127,0	5.00	0,60	0.39
GH195-8	12,7	0.50	22,1	0.87	297,0	4250	1190,0	17000	177,8	7.00	0,68	0.46
GH195-10	16,0	0.63	25,2	0.99	227,0	3250	897,0	13000	203,2	8.00	0,80	0.54
GH195-12	19,1	0.75	29,5	1.16	210,0	3000	840,0	12000	241,3	9.50	1,00	0.67
GH195-16	25,4	1.00	37,9	1.49	175,0	2500	700,0	10000	304,8	12.00	1,44	0.97
GH195-20	31,8	1.25	48,8	1.92	157,0	2250	630,0	9000	419,1	16.50	2,39	1.60
GH195-24	38,1	1.50	54,6	2.15	122,0	1750	490,0	7000	508,0	20.00	2,60	1.74
GH195-32	50,8	2.00	67,8	2.67	105,0	1500	420,0	6000	635,0	25.00	3,38	2.27

Construction

AQP elastomer tube, double wire braid reinforcement and blue AQP elastomer cover.

Operating Temperature Range

-40°C to +150°C [-40°F to +300°F]

Application

Petroleum and fire resistant hydraulic fluids, fuel and lubricating systems. For more information on specific fluid applications and high temperature ratings, see pages 349-355.

For Complete Agency Listings

See pages 346-348.

Fitting Reference Page

<i>Crimp</i>	
TTC	66
Skive Nipple	66
Socket Data	64

FC195 AQP HI-IMPULSE Double wire braid



Meets or exceeds:
SAE 100R2A, EN853 2ST, ISO 1436-1 Type 2ST

# Part Number	Hose I.D.		Hose O.D.		Maximum Operating Pressure		Minimum Burst Pressure		Minimum Bend Radius		Weight of Hose	
	mm	in	mm	in	bar	psi	bar	psi	mm	in	Kg/m	lbs/ft
FC195-04	6,4	0.25	17,5	0.69	400,0	5800†	1600,0	23200†	101,6	4.00	0,46	0.31
FC195-06	9,7	0.38	21,3	0.84	350,0	5000†	1400,0	20000†	127,0	5.00	0,62	0.42
FC195-08	12,7	0.50	24,6	0.97	280,0	4000	1120,0	16000	177,8	7.00	0,76	0.51
FC195-10	16,0	0.63	27,7	1.09	297,0	4250†	1190,0	17000†	203,2	8.00	0,88	0.59
FC195-12	19,1	0.75	31,8	1.25	245,0	3500	980,0	14000	241,3	9.50	1,12	0.75
FC195-16	25,4	1.00	39,6	1.56	227,0	3250†	1000,0	14500†	304,8	12.00	1,55	1.04
FC195-20	31,8	1.25	50,8	2.00	192,0	2750	770,0	11000	419,1	16.50	2,50	1.68
FC195-24	38,1	1.50	57,2	2.25	216,0	3125†	870,0	12500†	508,0	20.00	2,84	1.91
FC195-32	50,8	2.00	69,9	2.75	210,0	3000	630,0	9000	635,0	25.00	3,56	2.39
FC195-16	25,4	1.00	39,6	1.56	175,0	2500†	700,0	10000†				
FC195-20	31,8	1.25	50,8	2.00	140,0	2000	560,0	8000				
FC195-24	38,1	1.50	57,2	2.25	157,0	2250†	630,0	9000†				
FC195-32	50,8	2.00	69,9	2.75	113,0	1625	455,0	6500				
					124,0	1800†	497,0	7200†				
					122,0	1750	350,0	5000				
					105,0	1500†	420,0	6000†				
					87,0	1250	315,0	4500				

Construction

AQP elastomer tube, double wire braid reinforcement and blue AQP elastomer cover.

Operating Temperature Range

-40°C to +150°C [-40°F to +300°F]

Application

Petroleum and fire resistant hydraulic fluids, fuel, and lubricating systems. For more information on specific fluid applications and high temperature ratings, see pages 349-355.

For Complete Agency Listings

See pages 346-348.

† Improved pressure performance when used with global crimp fittings.

Fitting Reference Page

Crimp	Page
Skive Nipple	66
Socket Data	64
Reusable	Page
Fitting	156
Socket Data	65

FC636 EPDM hose Four spiral wire



# Part Number	Hose I.D.		Hose O.D.		Maximum Operating Pressure		Minimum Burst Pressure		Minimum Bend Radius		Weight of Hose	
	mm	in	mm	in	bar	psi	bar	psi	mm	in	Kg/m	lbs/ft
FC636-12	19,1	0.75	30,5	1.20	280,0	4000	1120,0	16000	241,3	9.50	1,31	0.88
FC636-16	25,4	1.00	37,6	1.48	280,0	4000	1120,0	16000	304,8	12.00	1,74	1.17
FC636-20	31,8	1.25	46,5	1.83	210,0	3000	840,0	12000	419,1	16.50	2,31	1.55
FC636-24	38,1	1.50	53,6	2.12	175,0	2500	700,0	10000	508,0	20.00	2,90	1.96

Construction

Synthetic EPDM tube, 4-spiral wire reinforcement, and green EPDM synthetic cover.

Operating Temperature Range

-40°C to +75°C (-40°F to +175°F).

Application

Ground support equipment (GSE), industrial phosphate ester based fluids, water glycol systems. For more information on specific fluid applications and high temperature ratings, see pages 349-355.

For Complete Agency Listings

See pages 346-348.

Fitting Reference Page

Crimp	Page
TTC12	66

FC323 AQP

High temperature Four spiral wire



# Part Number	Hose I.D.		Hose O.D.		Maximum Operating Pressure		Minimum Burst Pressure		Minimum Bend Radius		Weight of Hose	
	mm	in	mm	in	bar	psi	bar	psi	mm	in	Kg/m	lbs/ft
FC323-12	19,1	0.75	30,5	1.20	210,0	3000	840,0	12000	241,3	9.50	1,40	0.94
FC323-16	25,4	1.00	37,6	1.48	210,0	3000	840,0	12000	304,8	12.00	1,82	1.22
FC323-20	31,8	1.25	47,2	1.86	210,0	3000	840,0	12000	419,1	16.50	2,53	1.70
FC323-24	38,1	1.50	53,6	2.11	210,0	3000	840,0	12000	508,0	20.00	3,27	2.20
FC323-32	50,8	2.00	66,8	2.63	210,0	3000	840,0	12000	635,0	25.00	4,78	3.21

Construction

AQP elastomer tube, 4-spiral wire reinforcement and a blue AQP elastomer cover.

Operating Temperature Range

-40°C to +150°C [-40°F to +300°F]

Application

Hydraulic system service with petroleum, fire-resistant, and water-base fluids, fuel, and lubricating systems. For more information on specific fluid applications and high temperature ratings, see pages 349-355.

For Complete Agency Listings

See pages 346-348.

Fitting Reference Page

Crimp	Page
Single Skive*	106
Internal Skive	118
Socket Data	64

* -12 thru -24 only

FC324 AQP

High temperature Four spiral wire



# Part Number	Hose I.D.		Hose O.D.		Maximum Operating Pressure		Minimum Burst Pressure		Minimum Bend Radius		Weight of Hose	
	mm	in	mm	in	bar	psi	bar	psi	mm	in	Kg/m	lbs/ft
FC324-08	12,7	0.50	23,1	0.91	280,0	4000	1120,0	16000	177,8	7.00	0,91	0.61
FC324-12	19,1	0.75	30,5	1.20	280,0	4000	1120,0	16000	241,3	9.50	1,47	0.99
FC324-16	25,4	1.00	37,6	1.48	280,0	4000	1120,0	16000	304,8	12.00	1,92	1.29

Construction

AQP elastomer tube, 4-spiral wire reinforcement and a blue AQP elastomer cover.

Operating Temperature Range

-40°C to +150°C [-40°F to +300°F]

Application

Hydraulic system service with petroleum, fire-resistant, and water-base fluids, fuel, and lubricating systems. For more information on specific fluid applications and high temperature ratings, see pages 349-355.

For Complete Agency Listings

See pages 346-348.

Fitting Reference Page

Crimp	Page
Single Skive (-12, -16)	106
Internal Skive (-12, -16)	118
Socket Data	64

Reusable

Fitting (-8 only)	169
Socket Data	65

FC325 AQP

Four spiral wire



#	Hose I.D.		Hose O.D.		Maximum Operating Pressure		Minimum Burst Pressure		Minimum Bend Radius		Weight of Hose	
	mm	in	mm	in	bar	psi	bar	psi	mm	in	Kg/m	lbs/ft
FC325-12	19,1	0.75	32,0	1.26	350,0	5000	1400,0	20000	241,3	9.50	1,62	1.09
FC325-16	25,4	1.00	38,6	1.52	350,0	5000	1400,0	20000	304,8	12.00	2,11	1.42

Construction

AQP elastomer tube, 4-spiral wire reinforcement and a blue AQP elastomer cover.

Operating Temperature Range

-40°C to +150°C [-40°F to +300°F]

Application

Hydraulic system service with petroleum, fire-resistant, and water-base fluids, fuel, and lubricating systems. For more information on specific fluid applications and high temperature ratings, see pages 349-355.

For Complete Agency Listings

See pages 346-348.

Fitting Reference Page

Crimp	
Internal Skive	123
Socket Data	64

GH493

MATCHMATE Plus

Four spiral wire



SAE 100R12, EN 856 Type R12

#	Hose I.D.		Hose O.D.		Maximum Operating Pressure		Minimum Burst Pressure		Minimum Bend Radius		Weight of Hose	
	mm	in	mm	in	bar	psi	bar	psi	mm	in	Kg/m	lbs/ft
GH493-6	9,7	0.38	20,1	0.79	280,0	4000	1120,0	16000	125,0	5.00	0,70	0.47
GH493-8	12,7	0.50	23,4	0.92	280,0	4000	1120,0	16000	180,0	7.00	0,88	0.59
GH493-10	16,0	0.63	28,2	1.11	280,0	4000	1120,0	16000	200,0	8.00	1,03	0.69
GH493-12	19,1	0.75	30,5	1.20	280,0	4000	1120,0	16000	240,0	9.50	1,37	0.92
GH493-16	25,4	1.00	37,6	1.48	280,0	4000	1120,0	16000	300,0	12.00	1,82	1.22
GH493-20	31,8	1.25	46,5	1.83	210,0	3000	840,0	12000	420,0	16.50	2,44	1.64
GH493-24	38,1	1.50	53,8	2.12	175,0	2500	700,0	10000	500,0	20.00	3,12	2.10
GH493-32	50,8	2.00	67,1	2.64	175,0	2500	700,0	10000	640,0	25.00	4,18	2.81

Construction

Synthetic rubber tube, 4-spiral wire reinforcement, black synthetic rubber cover.

Operating Temperature Range

-40°C to +121°C [-40°F to +250°F]

Application

Hydraulic system service with petroleum and water-base fluids, for general industrial use. For more information on specific fluid applications and high temperature ratings, see pages 349-355.

For Complete Agency Listings

See pages 346-348.

Fitting Reference Page

Crimp	
TTC12	66
Single Skive	106
Socket Data	64
Reusable	
Fitting	169
Socket Data	65

FC659

Flexible, 1/2 SAE bend radius

Four spiral wire

Exceeds SAE 100R12, EN856 Type R12



# Part Number	Hose I.D.		Hose O.D.		Maximum Operating Pressure		Minimum Burst Pressure		Minimum Bend Radius		Weight of Hose	
	mm	in	mm	in	bar	psi	bar	psi	mm	in	Kg/m	lbs/ft
FC659-06	9,7	0.38	20,1	0.79	280,0	4000	1120,0	16000	62,5*	2.50*	0,70	0.47
FC659-08	12,7	0.50	23,4	0.92	280,0	4000	1120,0	16000	90,0*	3.50*	0,85	0.57
FC659-10	16,0	0.63	28,2	1.11	280,0	4000	1120,0	16000	100,0*	4.00*	1,04	0.70
FC659-12	19,1	0.75	30,5	1.20	280,0	4000	1120,0	16000	120,0*	4.75*	1,34	0.90
FC659-16	25,4	1.00	37,6	1.48	280,0	4000	1120,0	16000	150,0*	6.00*	1,80	1.21
FC659-20	31,8	1.25	46,5	1.83	210,0	3000	840,0	12000	210,0*	8.25*	2,43	2.40
FC659-24	38,1	1.50	55,0	2.17	175,0	2500	700,0	10000	250,0*	10.00*	3,06	2.06
FC659-32	50,8	2.00	68,3	2.69	175,0	2500	700,0	10000	320,0*	12.50*	4,44	2.99

Construction

Synthetic rubber tube, 4-spiral wire reinforcement and synthetic rubber cover.

Operating Temperature Range

-40°C to +121°C [-40°F to +250°F]

Application

Hydraulic system service with petroleum and water-base fluids requiring premium performance and flexibility. For more specific information on fluid applications, see pages 349-355.

For Complete Agency Listing

See pages 346-348.

* 1/2 SAE Bend Radius

Fitting Reference Page

Crimp	Page
TTC12	66

FC136

Four spiral wire

Exceeds SAE 100R12, EN 856 Type R12



# Part Number	Hose I.D.		Hose O.D.		Maximum Operating Pressure		Minimum Burst Pressure		Minimum Bend Radius		Weight of Hose	
	mm	in	mm	in	bar	psi	bar	psi	mm	in	Kg/m	lbs/ft
FC136-06	9,7	.38	20,1	.79	385,0 280,0	5500 4000*	1517,0 1120,0	22000 16000*	125,0	5.00	0,70	0.45
FC136-08	12,7	.50	23,4	.92	350,0 280,0	5000 4000*	1400,0 1120,0	20000 16000*	180,0	7.00	0,88	0.60
FC136-10	16,0	.63	28,2	1.11	350,0 280,0	5000 4000*	1400,0 1120,0	20000 16000*	200,0	8.00	1,00	0.67
FC136-12	19,1	.75	30,5	1.20	280,0	4000	1120,0	16000	240,0	9.50	1,34	0.90
FC136-16	25,4	1.00	37,6	1.48	280,0	4000	1120,0	16000	300,0	12.00	1,77	1.19
FC136-20	31,8	1.25	46,5	1.83	210,0	3000	840,0	12000	420,0	16.50	2,38	1.60
FC136-24	38,1	1.50	53,8	2.12	175,0	2500	700,0	10000	500,0	20.00	2,99	2.01
FC136-32	50,8	2.00	67,1	2.64	175,0	2500	700,0	10000	640,0	25.00	4,36	2.93

Construction

Synthetic rubber tube, 4-heavy spiral wire reinforcement, synthetic rubber cover.

Operating Temperature Range

-40°C to +121°C (-40°F to +250°F)

Application

Hydraulic system service with petroleum and water-base fluids, for general industrial use. For more information on specific fluid applications and high temperature ratings, see pages 349-355.

*Pressure rating with TTC12 fittings and reusables

For Complete Agency Listings

See pages 346-348.

Accessories and Assembly Instructions see pages 294-326.

Fitting Reference Page

Crimp	Page
TTC12	66
Single Skive	106
Internal Skive**	118
Socket Data	64
Reusable	
Fitting	169
Socket Data	65

* -16 thru -32 only

FC736 BRUISER

Ultra-abrasion resistant cover

Four spiral wire

Exceeds SAE 100R12, EN 856 Type R12



#	Hose I.D.		Hose O.D.		Maximum Operating Pressure		Minimum Burst Pressure		Minimum Bend Radius		Weight of Hose	
	mm	in	mm	in	bar	psi	bar	psi	mm	in	Kg/m	lbs/ft
FC736-06	9,7	.38	20,1	.79	385,0	5500	1517,0	22000	127,0	5.00	0,70	0.47
FC736-08	12,7	.50	23,4	.92	350,0	5000	1400,0	20000	177,8	7.00	0,88	0.59
FC736-10	16,0	.63	28,2	1.11	280,0	4000*	1120,0	16000*	241,3	9.50	1,19	0.80
FC736-12	19,1	.75	30,5	1.20	280,0	4000	1120,0	16000	241,3	9.50	1,37	0.92
FC736-16	25,4	1.00	37,6	1.48	280,0	4000	1120,0	16000	304,8	12.00	1,82	1.22
FC736-20	31,8	1.25	46,5	1.83	210,0	3000	840,0	12000	419,1	16.50	2,44	1.64
FC736-24	38,1	1.50	55,1	2.17	175,0	2500	700,0	10000	508,0	20.00	2,99	2.01
FC736-32	50,8	2.00	68,3	2.69	175,0	2500	700,0	10000	635,0	25.00	4,37	2.94

Construction

Synthetic rubber tube, 4-heavy spiral wire reinforcement, synthetic rubber intermediate cover, and BRUISER outer cover.

Operating Temperature Range

-40°C to +121°C (-40°F to +250°F)

Application

High abrasion industrial and hydraulic system applications with petroleum and water-based fluids. Recommended for use on critical applications in construction, forestry, and other off-highway vehicles. BRUISER outer cover offers unmatched abrasion, chemical and environmental protection. For more information on

specific fluid applications and temperature ratings, see pages 349-355.

For Complete Agency Listings

See pages 346-348.

*Pressure rating with TTC12 fittings and reusables.

Fitting Reference Page

<i>Crimp</i>	
TTC12	66
Single Skive	106
Internal Skive (-16, -20)	118
Socket Data	64
<i>Reusable</i>	
Fitting	169
Socket Data	65

FC254

Four heavy spiral wire

Exceeds SAE 100R11, EN 856 4SP



#	Hose I.D.		Hose O.D.		Maximum Operating Pressure		Minimum Burst Pressure		Minimum Bend Radius		Weight of Hose	
	mm	in	mm	in	bar	psi	bar	psi	mm	in	Kg/m	lbs/ft
FC254-08*	12,7	0.50	24,9	0.98	525,0	7500†	2100,0	30000	203,2	8.00	0,70	0.47
FC254-12	19,1	0.75	32,0	1.26	435,0	6250	1750,0	25000	279,4	11.00	0,88	0.59
FC254-16	25,4	1.00	38,6	1.52	350,0	5000	1400,0	20000	304,8	12.00	1,03	0.69
FC254-20	31,8	1.25	45,7	1.80	280,0	4000	1120,0	16000	419,1	16.50	1,37	0.92
FC254-24	38,1	1.50	54,1	2.13	210,0	3000	840,0	12000	508,0	20.00	1,82	1.22
FC254-32	50,8	2.00	68,1	2.68	210,0	3000	840,0	12000	635,0	25.00	2,44	1.64

Construction

Synthetic rubber tube, 4-heavy spiral wire reinforcement and synthetic rubber cover.

Operating Temperature Range

-40°C to +121°C [-40°F to +250°F]

Application

Hydraulic system service with petroleum and water-base fluids, for general industrial use. For more specific information on fluid applications, see pages 349-355.

For Complete Agency Listings

See pages 346-348.

† Rated at 10,000 psi for water blast applications using internal skive fittings.

* Available with BRUISER cover as FC854-08.

Fitting Reference Page

<i>Crimp</i>	
Spiral TTC	97
Single Skive (-20, -24)	106
Internal Skive	118
Socket Data	64

FC273

Four or six spiral wire

SAE 100R13, EN 856 Type R13, ISO 3862 Type R13



#	Hose I.D.		Hose O.D.		Maximum Operating Pressure		Minimum Burst Pressure		Minimum Bend Radius		Weight of Hose	
	mm	in	mm	in	bar	psi	bar	psi	mm	in	Kg/m	lbs/ft
FC273-12	19,1	0.75	32,0	1.26	350,0	5000	1400,0	20000	240,0	9.50	1,56	1.05
FC273-16	25,4	1.00	38,6	1.52	350,0	5000	1400,0	20000	300,0	12.00	1,96	1.32
FC273-20	31,8	1.25	49,8	1.96	350,0	5000	1400,0	20000	420,0	16.50	3,66	2.46
FC273-24	38,1	1.50	57,4	2.26	350,0	5000	1400,0	20000	500,0	20.00	4,70	3.16
FC273-32	50,8	2.00	71,1	2.80	350,0	5000	1400,0	20000	640,0	25.00	7,11	4.78

Construction

Synthetic rubber tube, multiple heavy spiral wire (4 wire for -12, -16; 6 wire for -20, -24 and -32); black synthetic rubber cover.

Operating Temperature Range

-40°C to +121°C [-40°F to +250°F]

Application

Hydraulic system service with petroleum and water-base fluids, for general industrial service. For more information on specific fluid applications and high temperature ratings, see pages 349-355.

For Complete Agency Listings

See pages 346-348.

Fitting Reference Page

Crimp	Page
Spiral TTC	97
Single Skive	113
Internal Skive	123
Socket Data	64

FC273B BRUISER

Ultra-abrasion resistant cover

Four or six spiral wire

SAE 100R13, EN 856 Type R13, ISO 3862 Type R13



#	Hose I.D.		Hose O.D.		Maximum Operating Pressure		Minimum Burst Pressure		Minimum Bend Radius		Weight of Hose	
	mm	in	mm	in	bar	psi	bar	psi	mm	in	Kg/m	lbs/ft
FC273B-12	19,1	0.75	33,3	1.31	350,0	5000	1400,0	20000	240,0	9.50	1,55	1.04
FC273B-16	25,4	1.00	39,9	1.57	350,0	5000	1400,0	20000	300,0	12.00	1,95	1.31
FC273B-20	31,8	1.25	51,3	2.02	350,0	5000	1400,0	20000	420,0	16.50	3,63	2.44
FC273B-24	38,1	1.50	58,9	2.32	350,0	5000	1400,0	20000	500,0	20.00	4,78	3.21
FC273B-32	50,8	2.00	72,6	2.86	350,0	5000	1400,0	20000	640,0	25.00	7,05	4.74

Construction

Synthetic rubber tube, multiple heavy spiral wire (4 wire for -12, -16; 6 wire for -20, -24 and -32); synthetic rubber intermediate cover and BRUISER outer cover.

Operating Temperature Range

-40°C to +121°C [-40°F to +250°F]

Application

High abrasion industrial and hydraulic system applications with petroleum and water-based fluids. Recommended for use on critical applications in construction, forestry, and other off-highway vehicles. BRUISER outer cover offers unmatched abrasion, chem-

ical and environmental protection. For more information on specific fluid applications and temperature ratings, see pages 349-355.

For Complete Agency Listings

See pages 346-348.

Fitting Reference Page







Crimp	Page
Spiral TTC	97

GH506

Four spiral wire

EN 856 4SH



#												
	Part Number	Hose I.D.		Hose O.D.		Maximum Operating Pressure		Minimum Burst Pressure		Minimum Bend Radius		Weight of Hose
	mm	in	mm	in	bar	psi	bar	psi	mm	in	Kg/m	lbs/ft
GH506-12*	19,1	0.75	32,3	1.27	420,0	6090	1680,0	24360	280,0	11.00	1,49	1.00
GH506-16*	25,4	1.00	38,4	1.51	380,0	5510	1520,0	22040	340,0	13.38	2,05	1.38
GH506-20*	31,8	1.25	45,5	1.79	350,0	5075	1400,0	20300	460,0	18.11	2,54	1.71
GH506-24*	38,1	1.50	53,6	2.11	300,0	4350	1200,0	17400	560,0	22.05	3,27	2.20
GH506-32*	50,8	2.00	68,1	2.68	250,0	3625	1000,0	14500	700,0	27.56	4,58	3.08

Construction

Synthetic rubber tube, 4-spiral wire reinforcement, synthetic rubber cover.

Operating Temperature Range

-40°C to +100°C [-40°F to +212°F]

Application

Four wire hose for high pressure hydraulic systems with petroleum and water-base fluids. For more information on specific fluid applications and high temperature ratings, see pages 349-355.

For Complete Agency Listings

See pages 346-348.

* Also available as an M100 length (GH506-12M100). This P/N is a minimum 100 feet in length.







Fitting Reference Page

Crimp	Page
Spiral TTC	97

GH466

Six spiral wire



#												
	Part Number	Hose I.D.		Hose O.D.		Maximum Operating Pressure		Minimum Burst Pressure		Minimum Bend Radius		Weight of Hose
	mm	in	mm	in	bar	psi	bar	psi	mm	in	Kg/m	lbs/ft
GH466-20	31,8	1.25	49,3	1.94	420,0	6090	1680,0	24000	420,0	16.50	3,48	2.34
GH466-24	38,1	1.50	57,4	2.26	420,0	6090	1680,0	24000	510,0	20.80	4,63	3.11

Construction

Synthetic rubber tube, 6-spiral wire reinforcement, synthetic rubber cover.

Operating Temperature Range

-40°C to +100°C [-40°F to +212°F]

Application

Six wire spiral hose for pressure systems with extreme pressure peaks. For use with petroleum and water-base fluids. For more information on specific fluid applications and high temperature ratings, see pages 349-355.

For Complete Agency Listings

See pages 346-348.

Fitting Reference Page

Crimp	Page
Spiral TTC	97

SPECIALTY & TRUCK HOSE

LOW & MEDIUM PRESSURE HOSE

HIGH PRESSURE HOSE

HOSE FITTINGS

ADAPTERS & TUBE FITTINGS

ACCESSORIES & ASSEMBLY INSTRUCTIONS

HOSE ASSEMBLY EQUIPMENT

APPENDICES

FC606

Six spiral wire

SAE 100R15



# Part Number	Hose I.D.		Hose O.D.		Maximum Operating Pressure		Minimum Burst Pressure		Minimum Bend Radius		Weight of Hose	
	mm	in	mm	in	bar	psi	bar	psi	mm	in	Kg/m	lbs/ft
FC606-16	25,4	1.00	41,9	1.65	420,0	6000	1680,0	24000	304,8	12.00	2,66	1.79
FC606-20	31,8	1.25	49,5	1.95	420,0	6000	1680,0	24000	419,1	16.50	3,62	2.43
FC606-24	38,1	1.50	58,4	2.30	420,0	6000	1680,0	24000	508,0	20.00	4,72	3.17

Construction

Synthetic rubber tube, 6-spiral wire reinforcement, synthetic rubber cover.

Operating Temperature Range

-40°C to +121°C [-40°F to +250°F]

Application

High-pressure hydraulics, hydrostatic transmissions. For more information on specific fluid applications and high temperature ratings, see pages 349-355.

For Complete Agency Listings

See pages 346-348.

Fitting Reference Page

Crimp	Page
Spiral TTC	97
Internal Skive	128
Socket Data	64

FC606B BRUISER

Ultra-abrasion resistant cover

Six spiral wire

SAE 100R15, ISO 3862 Type R15



# Part Number	Hose I.D.		Hose O.D.		Maximum Operating Pressure		Minimum Burst Pressure		Minimum Bend Radius		Weight of Hose	
	mm	in	mm	in	bar	psi	bar	psi	mm	in	Kg/m	lbs/ft
FC606B-16	25,4	1.00	42,9	1.69	420,0	6000	1680,0	24000	304,8	12.00	2,60	1.79
FC606B-20	31,8	1.25	51,6	2.03	420,0	6000	1680,0	24000	419,1	16.50	3,57	2.43
FC606B-24	38,1	1.50	58,9	2.32	420,0	6000	1680,0	24000	508,0	20.00	4,57	3.07

Construction

Synthetic rubber tube, 6-spiral wire reinforcement, synthetic rubber intermediate cover and BRUISER outer cover.

Operating Temperature Range

-40°C to +121°C [-40°F to +250°F]

Application

High-abrasion industrial and hydraulic system applications with petroleum and water-based fluids. Recommended for use on critical applications in construction, forestry, and other off-highway vehicles. BRUISER outer

cover offers unmatched abrasion, chemical, and environmental protection. For more information on specific fluid applications and temperature ratings, see pages 349-355

For Complete Agency Listings

See pages 346-348.

Fitting Reference Page

Crimp	Page
Spiral TTC	97

FC579

10,000 PSI Jack Hose

Double wire braid

Meets IJ100 requirements



SPECIALTY & TRUCK HOSE

LOW & MEDIUM PRESSURE HOSE

HIGH PRESSURE HOSE

HOSE FITTINGS

ADAPTERS & TUBE FITTINGS

ACCESSORIES & ASSEMBLY INSTRUCTIONS

HOSE ASSEMBLY EQUIPMENT

APPENDICES

# Part Number	Hose I.D.		Hose O.D.		Maximum Operating Pressure		Minimum Burst Pressure		Minimum Bend Radius		Weight of Hose	
	mm	in	mm	in	bar	psi	bar	psi	mm	in	Kg/m	lbs/ft
FC579-04	6,4	0.25	13,5	0.53	700,0	10000	1400,0	20000	50,8	2.00	0,33	0.22
FC579-06	9,7	0.38	17,5	0.69	700,0	10000	1400,0	20000	63,5	2.50	0,43	0.29

Construction

Synthetic rubber tube, double wire braid reinforcement and synthetic rubber cover.

Operating Temperature Range

-40°C to +100°C [-40°F to +212°F]

Application

Hydraulic jacking system service with petroleum and water-base fluids. Meets the performance requirements of the Material Handling Institute Specification IJ100. For more information on specific fluid applications and high temperature ratings, see pages 349-355.

For Complete Agency Listings

See pages 346-348.

Fitting Reference Page

Crimp	Page
TTC	66
Skive Nipple	66
Socket Data	64

Hose Fittings Index

Alphabetical Index

DESCRIPTION	PAGES
100R5 Crimp Fittings	134-135
Hose to Fitting Chart	58-60
How to Order	61-62
Global Crimp Fittings	66-105
Global OTC (Over the Cover)	66-96
Global Skive Nipples	66-96

DESCRIPTION	PAGES
Global Socket Data	63-64
Global TTC (Through-the-Cover)	66-96
Global TTC12	66-96
Global Spiral TTC	97-105
Internal Skive Crimp Fittings	118-128

DESCRIPTION	PAGES
LifeSaver Fittings	138, 148, 152, 157, 166
O-Rings	192-195
PTFE Crimp Fittings	129-132
Reusable Fittings	148-185
Reusable Fittings - 100R5	136-147
Socket Data – Crimp	63-64

DESCRIPTION	PAGES
Socketless	176-181
Spiral Single Skive Crimp Fittings	106-117
Split Flanges	190-193
Suction Hose Fittings	133
Super Gem	186-189



SPECIALTY & TRUCK HOSE
 LOW & MEDIUM PRESSURE HOSE
 HIGH PRESSURE HOSE
 HOSE FITTINGS
 ADAPTERS & TUBE FITTINGS
 ACCESSORIES & ASSEMBLY INSTRUCTIONS
 HOSE ASSEMBLY EQUIPMENT
 APPENDICES

Hose To Fitting Chart

Hose Part No.	CRIMP FITTINGS										REUSABLE FITTINGS	
	100R5 Crimp	PTFE Crimp	Global Nipples	Global OTC	Global TTC	Global TTC12	Global Spiral TTC	Internal Skive	Spiral Single Skive	Sockets	Reusable	Sockets
CR170	Contact Eaton for fitting information											
FC136						66		118	106	64	169	65
FC194			66							64		
FC195			66							64	156	65
FC211			66		66					64	148	65
FC212			66		66					64	165	65
FC234	134										136	65
FC252											184	
FC254							97	118	106 118	64		
FC273/ FC273B							97	123	113	64		
FC300	134										136	65
FC310			66		66					64	151	65
FC321											136	65
FC323								118	106	64		
FC324								118	106 115	64	169	65
FC325								123		64		
FC332											176	
FC350	134										136	65
FC352											184	
FC355	134										136	65
FC363		131								64		
FC364		131								64		
FC465		129								64	186	65
FC466			66	66						64		
FC469	Contact Eaton for fitting information											
FC498			66	66						64		
FC510			66		66					64	151	65
FC563	Contact Eaton for fitting information											
FC579			66		66					64		
FC598			66	66						64		
FC606/ FC606B							97	128		64		
FC611					66							
FC619				66	66					64	66	
FC629	Contact Eaton for fitting information											

This page is part of a complete catalog which contains technical and safety data that must be reviewed when selecting a product.

Continued on next page.

SPECIALTY & TRUCK HOSE

LOW & MEDIUM PRESSURE HOSE

HIGH PRESSURE HOSE

HOSE FITTINGS

ADAPTERS & TUBE FITTINGS

ACCESSORIES & ASSEMBLY INSTRUCTIONS

HOSE ASSEMBLY EQUIPMENT

APPENDICIES

Hose To Fitting Chart (continued)

SPECIALTY & TRUCK HOSE

LOW & MEDIUM PRESSURE HOSE

HIGH PRESSURE HOSE

HOSE FITTINGS

ADAPTERS & TUBE FITTINGS

ACCESSORIES & ASSEMBLY INSTRUCTIONS

HOSE ASSEMBLY EQUIPMENT

APPENDICES

Hose Part No.	CRIMP FITTINGS										REUSABLE FITTINGS	
	100R5 Crimp	PTFE Crimp	Global Nipples	Global OTC	Global TTC	Global TTC12	Global Spiral TTC	Internal Skive	Spiral Single Skive	Sockets	Reusable	Sockets
FC636						66						
FC639/ FC839B			66		66						64	
FC647											176	
FC650	Contact Eaton for fitting information											
FC659						66						
FC693					66							
FC699				66								
FC735					66						64	
FC736						66		118	106		64	169
FC807		129									64	186
FC829	Contact Eaton for fitting information											
FC849/ FC849B			66		66						64	
302A											136	65
303											136	65
1503	134										136	65
1531											185	65
1531A											185	65
2550											182	65
2554											182	65
2556											176	
2565											176	
2570											182	65
2575											176	
2580											136	65
2583				66								
2651											136	65
2661			66	66	66						64	64
2681			66								64	
2766			66								64	156
2781			66								64	156
2807		129									64	186
2808												175
GH120			66			66					64	
GH194			66		66						64	
GH195			66		66						64	
GH466							97					
GH493						66			106		64	169
GH506							97					
GH663			66		66						64	148
GH681			66		66						64	
GH781			66		66						64	
GH793			66		66						64	165

This page is part of a complete catalog which contains technical and safety data that must be reviewed when selecting a product.

How to Order

Accurate processing and prompt delivery of your order depend on easy identification of your requirements. Please order Eaton parts using correct part numbers as described in this catalog. Inquiries and orders should be directed to your Aeroquip Distributor or:

Eaton Hydraulics
14615 Lone Oak Road
Eden Prairie, MN 55344
USA
952/937-9800;
Fax: 952/974-7722
www.hydraulics.eaton.com

Part Numbers and Dash Sizes

Dash size designates the nominal size in 16ths of an inch. This number immediately follows the part number and is separated from it with a dash.

Fittings with "FC" or "FJ" part numbers will have the size expressed in four numerals. The first two numerals indicate the size of the connecting end and the second two numerals indicate the size of the hose end. All other fittings are followed by a dash number which is the nominal size of the fitting expressed in 16ths of an inch. Where two dash numbers are given, the first one generally indicates the pipe or port size and the second indicates the tube or hose size. The hose dash number should always be the same as the last dash number on the fitting.

Material Designation

Most fittings in this catalog have a material designation as part of the part number. An explanation is shown below.

Prefix Designations

- 38 Brass nipple, steel socket
- 44 Bronze nipple and nut: brass socket
- 63 Brass nipple, steel nut and socket
- 259 316 Stainless steel
- 449 Malleable iron

Suffix Designations

- B Brass
- C Stainless steel
- D Aluminum alloy
- S Steel

Dimensions

Dimensions given in this catalog for Eaton brand products are approximate and should be used for reference only. Exact dimensional information for a given product is subject to change and varying tolerances; contact Eaton directly for full current information.

Globally Standardized Pressure Ratings

Eaton has standardized hose burst and operating pressure ratings in cataloging, worldwide. This move toward standardization will slightly alter some of the pressures ratings listed for hoses in this catalog as pressures are rounded off. This is a paper conversion only. This action has no effect on the actual testing and certification of Eaton hoses to stringent product standards.

WARNING

Eaton manufactures the terminal ends of our hose fittings to the appropriate requirements established by the SAE. Therefore, the performance ratings of these hose fittings meet the SAE requirements. It is possible to order a hose assembly with a fitting terminal end that has a performance rating lower than the hose rating. When ordering hose assemblies, please keep the terminal end performance rating in mind since this may affect overall hose assembly performance.

Many hose assembly components (hose and fittings) are easily assembled in the field. However, factory assembled swaged, crimped and reusable hose assemblies are available. For complete information, contact Eaton.

MIXING/MATCHING

EATON FITTING TOLERANCES ARE ENGINEERED TO MATCH AEROQUIP HOSE TOLERANCES. THE USE OF EATON FITTINGS ON HOSE SUPPLIED BY OTHER MANUFACTURERS AND/OR THE USE OF AEROQUIP HOSE WITH FITTINGS SUPPLIED BY OTHER MANUFACTURERS' BRANDS MAY RESULT IN THE PRODUCTION OF UNRELIABLE AND UNSAFE HOSE ASSEMBLIES AND IS NEITHER RECOMMENDED NOR AUTHORIZED BY EATON CORPORATION

EATON SHALL NOT BE SUBJECT TO AND DISCLAIMS ANY OBLIGATIONS OR LIABILITIES (INCLUDING BUT NOT LIMITED TO ALL CONSEQUENTIAL, INCIDENTAL AND CONTINGENT DAMAGES) ARISING OUT OF BREACH OF CONTACT OR OF WARRANTY OR ARISING FROM TORT CLAIMS (INCLUDING WITHOUT LIMITATION NEGLIGENCE AND STRICT LIABILITY) OR OTHER THEORIES OF LAW WITH RESPECT TO ANY HOSE ASSEMBLIES NOT PRODUCED FROM GENUINE EATON HOSE FITTINGS, HOSE AND EATON APPROVED EQUIPMENT, AND IN CONFORMANCE WITH EATON PROCESS AND PRODUCT INSTRUCTIONS FOR EACH SPECIFIC HOSE ASSEMBLY.

FAILURE TO FOLLOW EATON PROCESS AND PRODUCT INSTRUCTIONS AND LIMITATIONS COULD LEAD TO PREMATURE HOSE ASSEMBLY FAILURES RESULTING IN PROPERTY DAMAGE, SERIOUS INJURY OR DEATH.

How To Order

Global Crimp Sockets, Nipples and Fittings

Global Part Numbering System

Part numbers collapse to the shortest possible number of digits:

It is assumed that a global fitting has a straight configuration unless a code is added to designate otherwise.

e.g., 1SA8FJ8 has a straight configuration
1SA8FJA8 has a 45° elbow configuration

Dashes and unnecessary zeros are not used.

e.g., 1/4" is designated by "4" not "-4" or "04"
5/8" is designated by "10" not "-10"

Global Crimp Sockets

Complete socket number: 1S A 8

Global 2-piece part number _____

Wire braid construction _____

A = Single wire braid

B = Double wire braid

Hose size* _____

Global Material Designation

Global crimp nipples, sockets and fittings standard material is zinc plated carbon steel. Items so designated in catalog are available in stainless steel.

Crimp fittings



Fittings are ordered as complete assemblies or as component parts.

Complete fitting number: FJ9896- 20 20 S

Basic part number _____

Pipe or port size _____

Mating hose size _____

Material designation suffix _____

Crimp socket



Complete socket number: FC2717- 20 S

Basic part number _____

Socket hose size _____

Material designation suffix _____

Crimp nipple



Complete nipple number: FC2710- 20 20 S

Basic part number _____

Socket or port size _____

Socket hose size _____

Material designation suffix _____

Reusable fittings

Fittings are ordered as complete assemblies.

Complete number: 412- 8 10 S

Basic part number _____

Pipe or port size (in 16ths of an inch) _____

Mating hose size _____

Material designation suffix _____

Global Crimp Nipples/Fittings

Complete nipple part number: 1S A 8 FJ A 8

Product group code _____

1S = Global 2-piece part number

1A = TTC fitting part number

1B = TTC12 fitting part number

1G = OTC Global fitting part number

1E = Spiral TTC fitting part number for four-spiral hose

1Z = Spiral TTC fitting part number for six-spiral hose

Material stock code _____

If material is round stock, then this position collapses.

A = inch hex stock

(metric hex, this position collapses)

For 1 1/4" Braided Hose Fittings:

P = 1-wire braid hose socket with no hex

R = 1-wire braid hose socket with inch hex

T = 2-wire braid hose socket with no hex

V = 2-wire braid hose socket with inch hex

End connection size* _____

End connection code _____

BF = BSP Female Swivel (1 hex)

BP = BSP Male Parallel

BT = BSP Male Tapered

CT = Cat Flange

DK = 24 Male (light duty)

DL = DKO Female Swivel (light duty)

DS = DKO Female Swivel (heavy duty)

EK = 24 Male (heavy duty)

FH = Flange Code 62

FJ = Female JIC Swivel

FL = Flange Code 61

FR = Female ORS

FS = Female SAE Swivel

JF = JIS Female Swivel

JM = BSP Female Swivel (2 hexes)

KF = Komatsu Female Swivel

KS = Komatsu Split Flange

MB = Male Boss O-Ring

MF = Male Inverted Flare

MJ = Male JIC

MP = Male Pipe

MR = Male ORS

PF = Female Pipe Swivel

PS = Pipe Swivel

Connecting end configuration code _____

If nipple has a straight configuration, then this position collapses.

A = 45°

D = 22 1/2°

B = 90°, standard or short drop

E = 67 1/2°

F = 30°

C = 90°, long drop

G = 60°

Hose size* _____

Material Designation _____

C = stainless steel, if fitting is zinc plated carbon steel (standard), this position collapses.

*When ordering sizes 3, 4, 5, 6 and 8 the part number requires only single digits.

SPECIALTY & TRUCK HOSE
LOW & MEDIUM PRESSURE HOSE
HIGH PRESSURE HOSE
HOSE FITTINGS
ADAPTERS & TUBE FITTINGS
ACCESSORIES & ASSEMBLY INSTRUCTIONS
HOSE ASSEMBLY EQUIPMENT
APPENDICES

Socket Data

Crimp Socket data— Socket to hose correct combinations

Use of the correct Eaton socket with a given Aeroquip hose is essential for proper assembly and performance. Virtually all Eaton hose sockets are marked with the socket part number and dash size. Using this number, from the following table, the correct hose or hoses may be found and dash sizes matched, to assure the correct combination.

Global Non-Skive Socket Identification (TTC, TTC-20, and TTC12 Sockets)

Through-the Cover fitting sockets for one wire and two wire braid hose in all sizes except -20 have one and two rings plus a scribe mark and TTC-(size) stamped on the socket. In the -20 size there are two sockets, one for one wire braid hose with one ring on the socket and one for two wire braid hose with two rings on the socket plus a scribe mark. Both -20 sockets have TTC-20 stamped on the sockets. Through-the Cover fitting sockets for four spiral hose have four rings plus a scribe mark and TTC12-(size) stamped on the socket.

SCRIBE MARK: For TTC and TTC12 Fittings, the scribe mark identifies crimp length indicator for assembly; See Document A-EQCR-TM001-E for details.

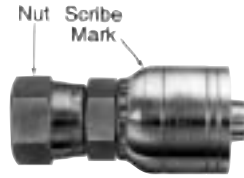

TTC-

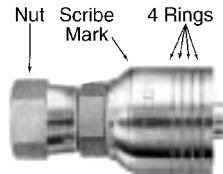

TTC12-

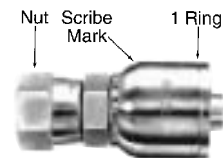

TTC-20

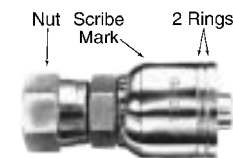

TTC-20

Global Over the Cover Identification (OTC Sockets)

Over the cover global fitting sockets have 1G(size) and a scribe mark stamped on the socket.

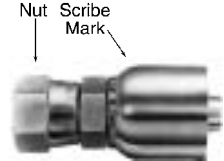

1G

Global Skive Socket Identification

1SA sockets are stamped 1SA(size) for one wire braid hose and 1SB sockets are stamped 1SB(size) for two wire braid hose. 1SA sockets have one ring and 1SB sockets have two rings grooved around the circumference of each socket.



1SA

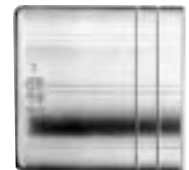

1SB

Global Identification Marking

Global hose fittings are identified with the Eaton trademark and the hose size. In addition, global sockets are identified with the following:

Identification Marking	Fitting Style	Hose/Socket Description
1 ring 1SA(size)	skive	One wire braid hose and skive type socket
2 rings 1SB(size)	skive	Two wire braid hose and skive type socket
2 rings 1 ring 1 scribe mark TTC-(size)	Thru-the-cover	One wire and two wire braid hose and TTC socket
4 rings 1 scribe mark TTC12-(size)	Spiral thru-the-cover	Four spiral wire hose and TTC12 socket
1 ring 1 scribe mark TTC-20	Thru-the-cover (-20 size only)	One wire braid -20 size hose and TTC socket
2 rings 1 scribe mark TTC-20	Thru-the-cover (-20 size only)	Two wire braid -20 size hose and TTC socket
1 scribe mark 1G (size)	Over the cover	Textile braid and suction hoses and OTC socket (SAE 100R3, R4 and R6 hose styles)

SPECIALTY & TRUCK HOSE

LOW & MEDIUM PRESSURE HOSE

HIGH PRESSURE HOSE

HOSE FITTINGS

ADAPTERS & TUBE FITTINGS





ACCESSORIES & ASSEMBLY INSTRUCTIONS





HOSE ASSEMBLY EQUIPMENT

APPENDICES

Socket Data

SPECIALTY & TRUCK HOSE
 LOW & MEDIUM PRESSURE HOSE
 HIGH PRESSURE HOSE
 HOSE FITTINGS
 ADAPTERS & TUBE FITTINGS
 ACCESSORIES & ASSEMBLY INSTRUCTIONS
 HOSE ASSEMBLY EQUIPMENT
 APPENDICES

Crimp sockets	Socket base part number	Aeroquip hose base part no.	Dash sizes		
	1SA	2681	-03 to -32		
		FC194	-04 to -20		
		FC211	-04 to -16		
		FC310	-04 to -20		
		FC510	-04 to -20		
		FC639/FC839B	-04 to -08		
		GH194	-04 to -20		
		GH663	-04 to -32		
		GH681	-04 to -08		
	1SB	2781	-4 to -32		
		FC195	-04 to -32		
		FC212	-04 to -32		
		FC466	-04 to -12		
		FC498/FC598	-04 to -12		
		FC579	-04, -06		
		FC639/FC839B	-10 to -16		
		FC735	-04 to -20		
		FC849/FC849B	-06 to -12		
		GH120	-04 to -20		
		GH195	-04 to -32		
		GH781	-04 to -20		
		GH793	-04 to -32		
			FC1410	FC136	-12, -16
				FC736	-12, -16
FC323	-12, -16				
GH493	-12, -16				
FC324	-12, -16				
	FW1097	FC699	-4 to -20		

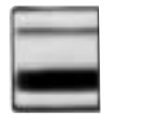
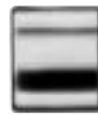
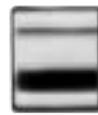
Crimp sockets	Socket base part number	Aeroquip hose base part no.	Dash sizes
	FC3471	FC136 GH493	-06 to -10
		FC736	
	FC1347	FC363	-08 to -32
		FC364	-08 to -32
	FC2540	FC1601	FC606 -16, -20
			FC136 -16 to -32
			FC736 -16 to -20
			FC254 -08, -16 to -32
			FC273 -16
			FC323 -16 to -32
			FC324 -16
			FC325 -16
			FC254 -12
			FC273 -12, -20 to -32
	FC2717	FC323	-12
		FC324	-12
		FC325	-12
	FC3023	2661	-40*, -48*
		FC619	-40*, -48*
	FC3443	2807	
		FC807	-05, -06, -10
		FC465	
		2807	
	FC3596	FC807	-03, -04, -08
		FC465	-12, -16

* Contact Eaton for crimp assembly information.









Socket Data





Reusable Socket Data— Socket to hose correction combinations

Use of the correct Eaton socket with a given Aeroquip hose is essential for proper assembly and performance. Virtually all

Eaton hose sockets are marked with the socket part number and dash size. Using this number, from the table below, the correct

hose or hoses may be found and dash sizes matched, to assure the correct combination.

Reusable sockets	Socket base part number	Aeroquip hose base part number	Dash sizes
	1206	2807, FC465, FC807	all
	1208	2808	all
	1210	303, 1503, 2580, 2651, FC234, FC300, FC321, FC350, FC355,	-4 to -12
	1212	302A, 1503, 1540, 2580, 2651, FC234, FC300, FC321, FC350, FC355,	-16 to -48
	1214	2550, 2554, 2570	-6, -8
	1219	1531, 1531A	all
	4007	FC136, GH493	-6, -12
	4010	2781	-4 to -12 -20 to -32
		FC195	-4 to -12 -20 to -32

Reusable sockets	Socket base part number	Aeroquip hose base part number	Dash sizes
	4013	2781	-16
		FC136	-08, -16
		FC195	-16
		FC324	-08
	FC2383	FC136, GH493	-20, -24
		FC2542	FC211, GH663
	FC2642	FC310	all
		FC510	-04 to -16
	FC2652	FC212, GH793	-04 to -16

SPECIALTY &
TRUCK HOSE

LOW & MEDIUM
PRESSURE HOSE

HIGH PRESSURE HOSE

HOSE FITTINGS

ADAPTERS &
TUBE FITTINGS

ACCESSORIES &
ASSEMBLY INSTRUCTIONS

HOSE ASSEMBLY
EQUIPMENT

APPENDICIES

Global Crimp Fittings Male Pipe (MP)

SPECIALTY & TRUCK HOSE

LOW & MEDIUM PRESSURE HOSE

HIGH PRESSURE HOSE

HOSE FITTINGS

ADAPTERS & TUBE FITTINGS

ACCESSORIES & ASSEMBLY INSTRUCTIONS

HOSE ASSEMBLY EQUIPMENT

APPENDICIES

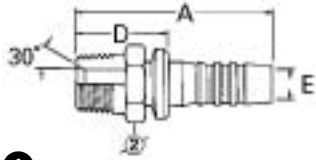

1
Global Nipples for use with Hose:
Clamp: 2661 (-12 thru -20), FC619 (-12 thru -20). **Socket 1SA:** 2681, FC194, FC211, FC310, FC510, FC639/FC839B (-4 thru -8), GH194 (-4 thru -20), GH663, GH681. **Socket 1SB:** 2781, FC195, FC212, FC466, FC498, FC598, FC579, FC639/FC839B (-10 thru -16), FC735 (-4 thru -20), FC849/FC849B (-06 thru -12), GH120 (-4 thru -20), GH195, GH781 (-04 thru -20), GH793, 2766.

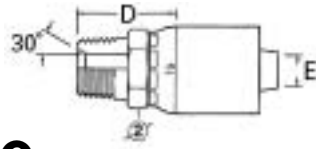

2
Global OTC Fittings for use with Hose: 2583, 2661, FC466, FC498, FC598, FC619, FC699

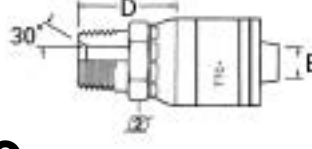

3
Global TTC Fittings for use with Hose: 2661(-12 thru -32), FC211, FC212, FC310, FC510, FC579, FC611, FC619 (-12 thru -32), FC639/FC839B, FC693, FC735, FC849/FC849B, GH120, GH194, GH195, GH663, GH681-6, GH781, GH793.

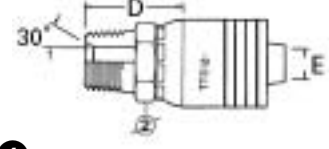

4
Global TTC12 Fittings for use with Hose: FC136, FC636, FC659, FC736, GH493.

1 Nipple Part #	2 OTC Part #	3 TTC Part #	4 TTC12 Part #	Thd.	Hose Size	A		D		EØ		in
						mm	in	mm	in	mm	in	
1SA2MP3	—	—	—	1/8-27	-03	40,4	1.59	22,9	0.90	2,5	0.10	7/16
1SA4MP3	—	—	—	1/4-18	-03	41,4	1.62	23,6	0.93	2,5	0.10	9/16
1SA2MP4	1GA2MP4	1AA2MP4	—	1/8-27	-04	46,7	1.84	23,4	0.92	4,3	0.17	9/16
1SA4MP4	1GA4MP4	1AA4MP4†	—	1/4-18	-04	52,3	2.06	29,0	1.14	4,3	0.17	9/16
1SA6MP4	1GA6MP4	1AA6MP4	—	3/8-18	-04	48,3	1.90	24,9	0.98	4,3	0.17	11/16
1SA4MP6	1GA4MP6	1AA4MP6	1BA4MP6	1/4-18	-06	55,4	2.18	30,0	1.18	6,6	0.26	11/16
1SA6MP6	1GA6MP6	1AA6MP6†	1BA6MP6	3/8-18	-06	57,7	2.27	32,5	1.28	6,6	0.26	11/16
1SA8MP6	1GA8MP6	1AA8MP6	1BA8MP6	1/2-14	-06	57,7	2.27	32,5	1.28	4,1	0.16	7/8
1SA4MP8	1GA4MP8	1AA4MP8	1BA4MP8	1/4-18	-08	61,0	2.40	31,2	1.23	7,6	0.30	13/16
1SA6MP8	1GA6MP8	1AA6MP8	1BA6MP8	3/8-18	-08	63,2	2.49	33,5	1.32	9,7	0.38	13/16
1SA8MP8	1GA8MP8	1AA8MP8†	1BA8MP8	1/2-14	-08	69,6	2.74	39,6	1.56	9,7	0.38	7/8
1SA12MP8	1GA12MP8	1AA12MP8	1BA12MP8	3/4-14	-08	65,0	2.56	35,3	1.39	9,7	0.38	11/16
1SA6MP10	—	1AA6MP10	—	3/8-18	-10	63,2	2.49	33,8	1.33	10,7	0.42	15/16
1SA8MP10	1GA8MP10	1AA8MP10	1BA8MP10	1/2-14	-10	69,6	2.74	40,1	1.58	12,7	0.50	15/16
1SA12MP10	1GA12MP10	1AA12MP10	1BA12MP10	3/4-14	-10	65,0	2.56	35,6	1.40	12,7	0.50	11/16
1SA8MP12	1GA8MP12	1AA8MP12	1BA8MP12	1/2-14	-12	70,6	2.78	40,6	1.60	14,2	0.56	11/8
1SA12MP12	1GA12MP12	1AA12MP12†	1BA12MP12	3/4-14	-12	72,1	2.84	41,9	1.65	15,5	0.61	11/8
1SA16MP12	1GA16MP12	1AA16MP12	1BA16MP12	1-11 1/2	-12	71,1	2.80	40,9	1.61	15,5	0.61	13/8
1SA12MP16	1GA12MP16	1AA12MP16	1BA12MP16	3/4-14	-16	76,7	3.02	42,4	1.67	19,3	0.76	13/8
1SA16MP16	1GA16MP16	1AA16MP16†	1BA16MP16	1-11 1/2	-16	81,8	3.22	47,2	1.86	20,8	0.82	13/8
1SA20MP16	1GA20MP16	1AA20MP16	1BA20MP16	1 1/4-11 1/2	-16	78,2	3.08	43,7	1.72	20,8	0.82	11 1/16
1SA16MP20	1GA16MP20	—	1BA16MP20	1-11 1/2	-20	93,0	3.66	49,0	1.93	24,1	0.95	13/4
—	—	1AR16MP20*	—	1-11 1/2	-20	93,0	3.66	49,0	1.93	24,1	0.95	13/4
—	—	1AV16MP20**	—	1-11 1/2	-20	93,0	3.66	49,0	1.93	24,1	0.95	13/4
1SA20MP20	1GA20MP20	—	1BA20MP20	1 1/4-11 1/2	-20	89,4	3.52	45,5	1.79	26,7	1.05	13 1/16
—	—	1AR20MP20*†	—	1 1/4-11 1/2	-20	89,4	3.52	45,5	1.79	26,7	1.05	13 1/16
—	—	1AV20MP20**†	—	1 1/4-11 1/2	-20	89,4	3.52	45,5	1.79	26,7	1.05	13 1/16
1SA24MP24	1GA24MP24	1AA24MP24	1BA24MP24	1 1/2-11 1/2	-24	106,2	4.18	59,9	2.36	32,0	1.26	2
1SA32MP32	1GA32MP32	1AA32MP32	—	2-11 1/2	-32	116,6	4.59	66,3	2.61	44,5	1.75	2 1/2
—	—	—	1BA32MP32	2-11 1/2	-32	128,5	5.06	65,5	2.58	44,5	1.75	2 1/2

* Uses 1-wire braid hose socket.

**Uses 2-wire braid hose socket.

† Also available in stainless steel, add suffix "C" to part number, i.e., 1AA4MP4C.

Female Pipe Swivel (PF)

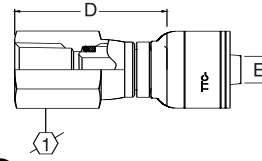
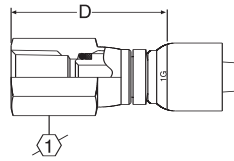
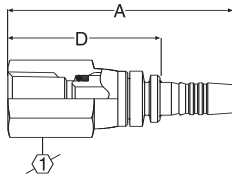

1
Global Nipples for use with Hose:
Clamp: 2661 (-12 thru -20), FC619 (-12 thru -20). **Socket 1SA:** 2681, FC194, FC211, FC310, FC372-03, FC510, FC639/FC839B (-4 thru -8), GH194 (-4 thru -20), GH663, GH681. **Socket 1SB:** 2781, FC195, FC212, FC466, FC498, FC598, FC579, FC639/FC839B (-10 thru -16), FC735 (-4 thru -20), FC849/FC849B (-06 thru -12), GH120 (-4 thru -20), GH195, GH781 (-04 thru -20), GH793, 2766.

2
Global OTC Fittings for use with Hose: 2583, 2661, FC466, FC498, FC598, FC619, FC699

3
Global TTC Fittings for use with Hose: 2661(-12 thru -32), FC211, FC212, FC310, FC510, FC579, FC611, FC619 (-12 thru -32), FC639/FC839B, FC693, FC735, FC849/FC849B, GH120, GH194, GH195, GH663, GH681-6, GH781, GH793.

1 Nipple Part #	2 OTC Part #	3 TTC Part #	TTC12 Part #	Thd.	Hose Size	A		D		EØ		in
						mm	in	mm	in	mm	in	
1SA4PF4	1GA4PF4	1AA4PF4	—	1/4-18	-04	72,9	2.87	49,5	1.95	4,3	0.17	3/4
1SA6PF6	1GA6PF6	1AA6PF6	—	3/8-18	-06	75,4	2.97	50,0	1.97	6,6	0.26	7/8
1SA8PF8	1GA8PF8	1AA8PF8	—	1/2-14	-08	90,9	3.58	61,2	2.41	9,7	0.38	1 1/16
1SA12PF12	1GA12PF12	1AA12PF12	—	3/4-14	-12	92,2	3.63	62,0	2.44	15,5	0.61	1 3/8

Male Pipe Swivel (PS)

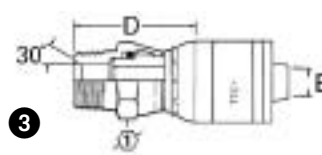
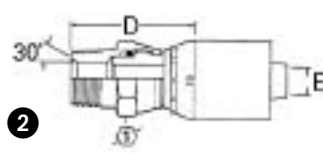
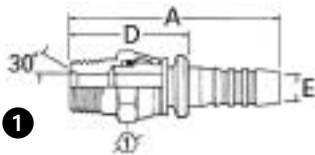

1 Nipple Part #	2 OTC Part #	3 TTC Part #	TTC12 Part #	Thd.	Hose Size	A		D		EØ		in
						mm	in	mm	in	mm	in	
1SA2PS3	—	—	—	1/8-27	-03	53,6	2.11	36,1	1.42	2,5	0.10	9/16
1SA4PS4	1GA4PS4	1AA4PS4	—	1/4-18	-04	64,5	2.54	41,4	1.62	4,3	0.17	3/4
1SA6PS6	1GA6PS6	1AA6PS6	—	3/8-18	-06	67,6	2.66	42,4	1.67	6,6	0.26	7/8
1SA8PS6	1GA8PS6	1AA8PS6	—	1/2-14	-06	72,4	2.85	47,0	1.85	6,6	0.26	7/8
1SA6PS8	1GA6PS8	1AA6PS8	—	3/8-18	-08	73,2	2.88	43,4	1.71	9,7	0.38	7/8
1SA8PS8	1GA8PS8	1AA8PS8	—	1/2-14	-08	79,5	3.13	49,8	1.96	9,7	0.38	1 5/16
1SA12PS12	1GA12PS12	1AA12PS12	—	3/4-14	-12	82,3	3.24	52,1	2.05	15,5	0.61	1 3/8
1SA16PS16	1GA16PS16	1AA16PS16	—	1-11 1/2	-16	98,6	3.88	64,3	2.53	20,6	0.81	1 1/2

Female JIC/SAE 37° Swivel (FJ)

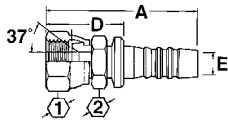

1
Global Nipples for use with Hose:
Clamp: 2661 (-12 thru -20), FC619 (-12 thru -20). **Socket 1SA:** 2681, FC194, FC211, FC310, FC510, FC639/FC839B (-4 thru -8), GH194 (-4 thru -20), GH663, GH681. **Socket 1SB:** 2781, FC195, FC212, FC466, FC498, FC598, FC579, FC639/FC839B (-10 thru -16), FC735 (-4 thru -20), FC849/FC849B (-06 thru -12), GH120 (-4 thru -20), GH195, GH781 (-04 thru -20), GH793, 2766.

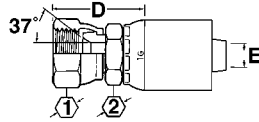

2
Global OTC Fittings for use with Hose: 2583, 2661, FC466, FC498, FC598, FC619, FC699

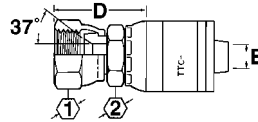

3
Global TTC Fittings for use with Hose: 2661 (-12 thru -32), FC211, FC212, FC310, FC510, FC579, FC611, FC619 (-12 thru -32), FC639/FC839B, FC693, FC735, FC849/FC849B, GH120, GH194, GH195, GH663, GH681-6, GH781, GH793.

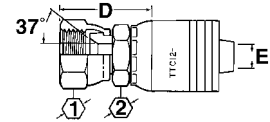

4
Global TTC12 Fittings for use with Hose: FC136, FC636, FC659, FC736, GH493.

1 Nipple Part #	2 OTC Part #	3 TTC Part #	4 TTC12 Part #	Thd.	Hose Size	A		D		EØ		1	2
						mm	in	mm	in	mm	in	in	in
1SA3FJ3	—	—	—	3/8-24	-03	42,3	1.69	25,4	1.00	2,5	0.10	1/2	7/16
1SA4FJ3	—	—	—	7/16-20	-03	42,3	1.69	25,4	1.00	2,5	0.10	9/16	7/16
1SA3FJ4	1GA3FJ4	1AA3FJ4	—	3/8-24	-04	49,3	1.94	25,9	1.02	3,3	0.13	1/2	9/16
1SA4FJ4	1GA4FJ4	1AA4FJ4†	—	7/16-20	-04	50,8	2.00	27,2	1.07	4,3	0.17	9/16	9/16
1SA5FJ4	1GA5FJ4	1AA5FJ4	—	1/2-20	-04	50,3	1.98	26,9	1.06	4,3	0.17	5/8	9/16
1SA6FJ4	1GA6FJ4	1AA6FJ4	—	9/16-18	-04	51,6	2.03	28,2	1.11	4,3	0.17	11/16	9/16
1SA5FJ5	1GA5FJ5	1AA5FJ5	—	1/2-20	-05	52,8	2.08	29,0	1.14	5,3	0.21	5/8	9/16
1SA6FJ5	1GA6FJ5	1AA6FJ5	—	9/16-18	-05	52,3	2.06	28,4	1.12	5,3	0.21	11/16	9/16
1SA4FJ6	1GA4FJ6	1AA4FJ6	1BA4FJ6	7/16-20	-06	55,6	2.19	30,2	1.19	4,3	0.17	9/16	11/16
1SA5FJ6	1GA5FJ6	1AA5FJ6	—	1/2-20	-06	56,9	2.24	31,5	1.24	5,8	0.23	5/8	11/16
1SA6FJ6	1GA6FJ6	1AA6FJ6†	1BA6FJ6	9/16-18	-06	57,9	2.28	32,5	1.28	6,6	0.26	11/16	11/16
1SA8FJ6	1GA8FJ6	1AA8FJ6	1BA8FJ6	3/4-16	-06	58,7	2.31	33,3	1.31	6,6	0.26	7/8	11/16
1SA10FJ6	—	—	—	7/8-14	-06	61,5	2.42	36,3	1.43	6,6	0.26	1	13/16
1SA8FJ8	1GA8FJ8	1AA8FJ8†	1BA8FJ8	3/4-16	-08	66,8	2.63	37,1	1.46	9,7	0.38	7/8	13/16
1SA10FJ8	1GA10FJ8	1AA10FJ8	1BA10FJ8	7/8-14	-08	67,1	2.64	37,3	1.47	9,7	0.38	1	13/16
1SA12FJ8	1GA12FJ8	1AA12FJ8	1BA12FJ8	1 1/16-12	-08	69,3	2.73	39,6	1.56	9,7	0.38	1 1/4	1
1SA16FJ8	1GA16FJ8	1AA16FJ8	1BA16FJ8	1 5/16-12	-08	77,7	3.06	48,0	1.89	9,7	0.38	1 1/2	1 1/4
1SA8FJ10	—	1AA8FJ10	—	3/4-16	-10	67,3	2.65	38,1	1.50	9,9	0.39	7/8	15/16
1SA10FJ10	1GA10FJ10	1AA10FJ10†	1BA10FJ10	7/8-14	-10	70,4	2.77	40,9	1.61	12,7	0.50	1	15/16
1SA12FJ10	1GA12FJ10	1AA12FJ10	1BA12FJ10	1 1/16-12	-10	69,1	2.72	39,9	1.57	12,7	0.50	1 1/4	1
1SA10FJ12	1GA10FJ12	1AA10FJ12	1BA10FJ12	7/8-14	-12	71,4	2.81	41,4	1.63	12,2	0.48	1	1 1/8
1SA12FJ12	1GA12FJ12	1AA12FJ12†	1BA12FJ12	1 1/16-12	-12	72,1	2.84	41,9	1.65	15,5	0.61	1 1/4	1 1/8
1SA14FJ12	1GA14FJ12	1AA14FJ12	1BA14FJ12	1 3/16-12	-12	72,1	2.84	41,9	1.65	15,5	0.61	1 3/8	1 1/8
1SA16FJ12	1GA16FJ12	1AA16FJ12	1BA16FJ12	1 5/16-12	-12	73,9	2.91	43,7	1.72	15,5	0.61	1 1/2	1 1/4
1SA12FJ16	1GA12FJ16	1AA12FJ16	1BA12FJ16	1 1/16-12	-16	80,0	3.15	45,7	1.80	15,5	0.61	1 1/4	1 3/8
1SA16FJ16	1GA16FJ16	1AA16FJ16†	1BA16FJ16	1 5/16-12	-16	83,6	3.29	49,0	1.93	20,6	0.81	1 1/2	1 3/8
1SA20FJ16	1GA20FJ16	1AA20FJ16	1BA20FJ16	1 5/8-12	-16	80,5	3.17	46,0	1.81	20,6	0.81	2	
1SA16FJ20	1GA16FJ20	—	1BA16FJ20	1 5/16-12	-20	87,9	3.46	43,9	1.73	21,6	0.85	1 1/2	
—	—	1AR16FJ20*	—	1 5/16-12	-20	87,9	3.46	43,9	1.73	21,6	0.85	1 1/2	
—	—	1AV16FJ20**	—	1 5/16-12	-20	87,9	3.46	43,9	1.73	21,6	0.85	1 1/2	
1SA20FJ20	1GA20FJ20	—	1BA20FJ20	1 5/8-12	-20	91,7	3.61	47,8	1.88	26,7	1.05	2	
—	—	1AR20FJ20*†	—	1 5/8-12	-20	91,7	3.61	47,8	1.88	26,7	1.05	2	
—	—	1AV20FJ20**†	—	1 5/8-12	-20	91,7	3.61	47,8	1.88	26,7	1.05	2	
1SA24FJ20	—	—	1BA24FJ20	1 7/8-12	-20	95,5	3.76	51,6	2.03	26,7	1.05	2 1/4	
1SA24FJ24	1GA24FJ24	1AA24FJ24	1BA24FJ24	1 7/8-12	-24	99,1	3.90	52,6	2.07	32,0	1.26	2 1/4	
1SA24FJ32	1GA24FJ32	1AA24FJ32	—	1 7/8-12	-32	103,9	4.09	53,8	2.12	33,3	1.31	2 1/4	
1SA32FJ32	1GA32FJ32	1AA32FJ32	—	2 1/2-12	-32	110,2	4.34	60,7	2.39	44,5	1.75	2 7/8	
—	—	—	1BA32FJ32	2 1/2-12	-32	122,4	4.82	59,2	2.33	44,5	1.75	2 7/8	

* Uses 1-wire braid hose socket.

**Uses 2-wire braid hose socket.

† Also available in stainless steel, add suffix "C" to part number, i.e., 1AA4FJ4C.

Female JIC/SAE 37° Swivel 45° Elbow (FJA)

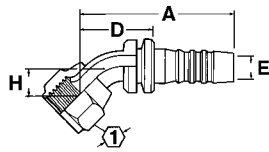

1
Global Nipples for use with Hose:
Clamp: 2661 (-12 thru -20), FC619 (-12 thru -20). **Socket 1SA:** 2681, FC194, FC211, FC310, FC510, FC639/FC839B (-4 thru -8), GH194 (-4 thru -20), GH663, GH681. **Socket 1SB:** 2781, FC195, FC212, FC466, FC498, FC598, FC579, FC639/FC839B (-10 thru -16), FC735 (-4 thru -20), FC849/FC849B (-06 thru -12), GH120 (-4 thru -20), GH195, GH781 (-04 thru -20), GH793, 2766.

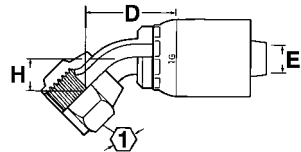

2
Global OTC Fittings for use with Hose: 2583, 2661, FC466, FC498, FC598, FC619, FC699

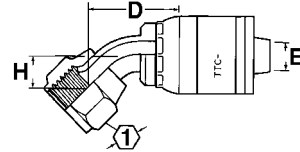

3
Global TTC Fittings for use with Hose: 2661(-12 thru -32), FC211, FC212, FC310, FC510, FC579, FC611, FC619 (-12 thru -32), FC639/FC839B, FC693, FC735, FC849/FC849B, GH120, GH194, GH195, GH663, GH681-6, GH781, GH793.

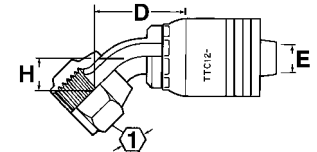

4
Global TTC12 Fittings for use with Hose: FC136, FC636, FC659, FC736, GH493.

1 Nipple Part #	2 OTC Part #	3 TTC Part #	4 TTC12 Part #	Thd.	Hose Size	A		D		EØ		H		① in
						mm	in	mm	in	mm	in	mm	in	
1SA4FJA4†	1GA4FJA4†	1AA4FJA4†	—	7/16-20	-04	49,8	1.96	26,4	1.04	3,8	0.15	8,4	0.33	9/16
1SA5FJA4†	1GA5FJA4†	1AA5FJA4†	—	1/2-20	-04	51,8	2.04	28,4	1.12	4,3	0.17	9,4	0.37	5/8
1SA6FJA4	1GA6FJA4	1AA6FJA4	—	9/16-18	-04	53,1	2.09	29,7	1.17	4,3	0.17	9,9	0.39	11/16
1SA6FJA6	1GA6FJA6	1AA6FJA6	—	9/16-18	-06	58,7	2.31	33,3	1.31	6,1	0.24	9,9	0.39	11/16
—	—	—	1BA6FJA6	9/16-18	-06	75,7	2.98	50,3	1.98	6,1	0.24	21,6	0.85	11/16
1SA8FJA6†	1GA8FJA6†	1AA8FJA6†	—	3/4-16	-06	67,3	2.65	42,2	1.66	6,6	0.26	14,0	0.55	7/8
—	—	—	1BA8FJA6	3/4-16	-06	79,5	3.13	54,4	2.14	6,6	0.26	24,1	0.95	7/8
1SA8FJA8†	1GA8FJA8†	1AA8FJA8†	—	3/4-16	-08	71,6	2.82	41,9	1.65	9,4	0.37	14,0	0.55	7/8
—	—	—	1BA8FJA8	3/4-16	-08	83,8	3.30	54,1	2.13	9,4	0.37	24,1	0.95	7/8
1SA10FJA8†	1GA10FJA8†	1AA10FJA8†	—	7/8-14	-08	77,0	3.03	47,2	1.86	9,7	0.38	15,0	0.59	1
—	—	—	1BA10FJA8	7/8-14	-08	85,1	3.35	55,4	2.18	9,4	0.37	25,4	1.00	1
1SA10FJA10†	1GA10FJA10†	1AA10FJA10†	—	7/8-14	-10	74,7	2.94	45,5	1.79	11,7	0.46	15,0	0.59	1
1SA12FJA10	1GA12FJA10	1AA12FJA10	—	1 1/16-12	-10	85,9	3.38	56,4	2.22	12,7	0.50	19,8	0.78	1 1/4
—	—	—	1BA12FJA10	1 1/16-12	-10	96,0	3.78	66,5	2.62	12,7	0.50	29,5	1.16	1 1/4
1SA12FJA12	1GA12FJA12	1AA12FJA12	—	1 1/16-12	-12	87,1	3.43	56,9	2.24	14,7	0.58	19,8	0.78	1 1/4
—	—	—	1BA12FJA12	1 1/16-12	-12	96,8	3.81	66,5	2.62	14,2	0.56	29,5	1.16	1 1/4
1SA20FJA16	1GA20FJA16	1AA20FJA16	—	1 5/8-12	-16	101,6	4.00	67,3	2.65	20,6	0.81	31,0	1.22	2
1SA16FJA16	1GA16FJA16	1AA16FJA16	—	1 5/16-12	-16	95,0	3.74	60,7	2.39	19,3	0.76	27,2	1.07	1 1/2
—	—	—	1BA16FJA16	1 5/16-12	-16	119,6	4.71	85,3	3.36	19,3	0.76	38,9	1.53	1 1/2
1SA20FJA20	1GA20FJA20	—	—	1 5/8-12	-20	112,8	4.44	68,8	2.71	25,7	1.01	31,0	1.22	2
—	—	—	1BA20FJA20	1 5/8-12	-20	138,4	5.45	94,5	3.72	25,7	1.01	43,2	1.70	2
—	—	1AR20FJA20*	—	1 5/8-12	-20	112,8	4.44	68,8	2.71	25,7	1.01	31,0	1.22	2
—	—	1AV20FJA20**	—	1 5/8-12	-20	112,8	4.44	68,8	2.71	25,7	1.01	31,0	1.22	2
—	—	—	1BA24FJA24	1 7/8-12	-24	159,3	6.27	112,8	4.44	30,2	1.19	50,5	1.99	2 1/4

* Uses 1-wire braid hose socket.

** Uses 2-wire braid hose socket.

† Swivel nuts are universal for both SAE 37° and SAE 45° connections.

SPECIALTY &
TRUCK HOSE

LOW & MEDIUM
PRESSURE HOSE

HIGH PRESSURE HOSE

HOSE FITTINGS

ADAPTERS &
TUBE FITTINGS

ACCESSORIES &
ASSEMBLY INSTRUCTIONS

HOSE ASSEMBLY
EQUIPMENT

APPENDICES

Female JIC/SAE 37° Swivel 90° Elbow (FJB)

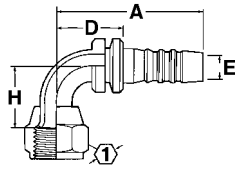

1
Global Nipples for use with Hose:
Clamp: 2661 (-12 thru -20), FC619 (-12 thru -20). **Socket 1SA:** 2681, FC194, FC211, FC310, FC510, FC639/FC839B (-4 thru -8), GH194 (-4 thru -20), GH663, GH681. **Socket 1SB:** 2781, FC195, FC212, FC466, FC498, FC598, FC579, FC639/FC839B (-10 thru -16), FC735 (-4 thru -20), FC849/FC849B (-06 thru -12), GH120 (-4 thru -20), GH195, GH781 (-04 thru -20), GH793, 2766.

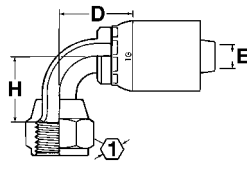

2
Global OTC Fittings for use with Hose: 2583, 2661, FC466, FC498, FC598, FC619, FC699

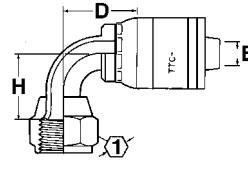

3
Global TTC Fittings for use with Hose: 2661(-12 thru -32), FC211, FC212, FC310, FC510, FC579, FC611, FC619 (-12 thru -32), FC639/FC839B, FC693, FC735, FC849/FC849B, GH120, GH194, GH195, GH663, GH681-6, GH781, GH793.

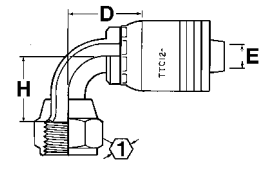

4
Global TTC12 Fittings for use with Hose: FC136, FC636, FC659, FC736, GH493.

1 Nipple Part #	2 OTC Part #	3 TTC Part #	4 TTC12 Part #	Thd.	Hose Size	A		D		EØ		H		1
						mm	in	mm	in	mm	in	mm	in	
1SA4FJB3†	—	—	—	7/16-20	-03	40,6	1.60	23,1	0.91	2,5	0.10	17,3	0.68	9/16
1SA4FJB4†	1GA4FJB4†	1AA4FJB4†	—	7/16-20	-04	46,7	1.84	23,4	0.92	3,8	0.15	17,3	0.68	9/16
1SA5FJB4†	1GA5FJB4†	1AA5FJB4†	—	1/2-20	-04	48,8	1.92	25,4	1.00	4,3	0.17	19,3	0.76	5/8
1SA6FJB4	1GA6FJB4	1AA6FJB4	—	9/16-18	-04	50,8	2.00	27,4	1.08	4,3	0.17	21,3	0.84	11/16
1SA5FJB5†	—	—	—	1/2-20	-05	49,5	1.95	25,7	1.01	4,6	0.18	19,3	0.76	5/8
1SA6FJB6	1GA6FJB6	1AA6FJB6	—	9/16-18	-06	56,1	2.21	31,0	1.22	6,1	0.24	21,3	0.84	11/16
—	—	—	1BA6FJB6	9/16-18	-06	61,2	2.41	36,1	1.42	6,1	0.24	38,1	1.50	11/16
1SA8FJB6†	1GA8FJB6†	1AA8FJB6†	—	3/4-16	-06	61,5	2.42	36,1	1.42	6,6	0.26	27,7	1.09	7/8
—	—	—	1BA8FJB6	3/4-16	-08	68,8	2.71	43,4	1.71	6,6	0.26	47,5	1.87	7/8
1SA6FJB8	1GA6FJB8	1AA6FJB8	—	9/16-18	-08	61,7	2.43	32,0	1.26	6,1	0.24	21,3	0.84	11/16
1SA8FJB8†	1GA8FJB8†	1AA8FJB8†	—	3/4-16	-08	65,8	2.59	36,1	1.42	9,4	0.37	27,7	1.09	7/8
—	—	—	1BA8FJB8	3/4-16	-08	72,9	2.87	43,2	1.70	9,4	0.37	47,5	1.87	7/8
1SA10FJB8†	1GA10FJB8†	1AA10FJB8†	—	7/8-14	-08	70,6	2.78	41,0	1.61	9,7	0.38	30,2	1.19	1
—	—	—	1BA10FJB8	7/8-14	-08	72,9	2.87	43,2	1.70	9,7	0.37	49,0	1.93	1
1SA10FJB10†	1GA10FJB10†	1AA10FJB10†	1BA10FJB10	7/8-14	-10	68,6	2.70	39,4	1.55	11,4	0.45	30,2	1.19	1
1SA12FJB8	—	—	—	1 1/16-12	-08	86,1	3.39	56,4	2.22	9,7	0.38	45,7	1.80	1 1/4
1SA12FJB10	1GA12FJB10	1AA12FJB10	—	1 1/16-12	-10	84,1	3.31	54,9	2.16	12,7	0.50	45,7	1.80	1 1/4
—	—	—	1BA12FJB10	1 1/16-12	-10	84,8	3.34	55,4	2.18	12,7	0.50	69,7	2.35	1 1/4
1SA12FJB12	1GA12FJB12	1AA12FJB12	—	1 1/16-12	-12	85,4	3.36	55,1	2.17	17,4	0.58	45,7	1.80	1 1/4
—	—	—	1BA12FJB12	1 1/16-12	-12	85,6	3.37	55,4	2.18	14,2	0.56	69,7	2.35	1 1/4
1SA16FJB12	1GA16FJB12	1AA16FJB12	—	1 5/16-12	-12	85,6	3.37	55,4	2.18	15,5	0.61	60,7	2.39	1 1/2
—	—	—	1BA16FJB12	1 5/16-12	-12	85,6	3.37	55,4	2.18	14,2	0.56	62,5	2.46	1 1/2
1SA16FJB16	1GA16FJB16	1AA16FJB16	—	1 5/16-12	-16	90,4	3.56	55,9	2.20	19,3	0.76	60,7	2.39	1 1/2
—	—	—	1BA16FJB16	1 5/16-12	-16	103,1	4.06	68,6	2.70	19,3	0.76	77,2	3.04	1 1/2
1SA16FJB20	—	—	—	1 5/16-12	-20	101,6	4.00	57,7	2.27	19,3	0.76	60,7	2.39	1 1/2
1SA20FJB20	1GA20FJB20	—	—	1 5/8-12	-20	108,0	4.25	64,0	2.52	25,7	1.01	69,9	2.75	2
—	—	—	1BA20FJB20	1 5/8-12	-20	120,7	4.75	76,7	3.02	25,7	1.01	86,4	3.40	2
—	—	1AR20FJB20*	—	1 5/8-12	-20	108,0	4.25	64,0	2.52	25,7	1.01	69,9	2.75	2
—	—	1AV20FJB20**	—	1 5/8-12	-20	108,0	4.25	64,0	2.52	25,7	1.01	69,9	2.75	2
—	—	—	1BA24FJB24	1 7/8-12	-24	137,2	5.40	90,9	3.58	30,2	1.19	100,3	3.95	2 1/4
1SA24FJB24	—	1AA24FJB24	—	1 7/8-12	-24	117,6	4.63	71,4	2.81	32,0	1.26	80,5	3.17	2 1/4

* Uses 1-wire braid hose socket.

**Uses 2-wire braid hose socket.

† Swivel nuts are universal for both SAE 37° and SAE 45° connections.

Female JIC/SAE 37° Swivel 90° Long Drop Elbow (FJC)

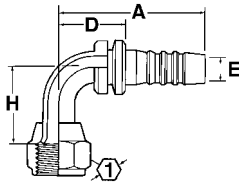

1

Global Nipples for use with Hose:
Clamp: 2661 (-12 thru -20), FC619 (-12 thru -20). **Socket 1SA:** 2681, FC194, FC211, FC310, FC510, FC639/FC839B (-4 thru -8), GH194 (-4 thru -20), GH663, GH681. **Socket 1SB:** 2781, FC195, FC212, FC466, FC498, FC598, FC579, FC639/FC839B (-10 thru -16), FC735 (-4 thru -20), FC849/FC849B (-06 thru -12), GH120 (-4 thru -20), GH195, GH781 (-04 thru -20), GH793, 2766.

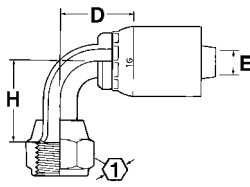

2

Global OTC Fittings for use with Hose: 2583, 2661, FC466, FC498, FC598, FC619, FC699

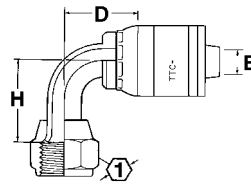

3

Global TTC Fittings for use with Hose: 2661(-12 thru -32), FC211, FC212, FC310, FC510, FC579, FC611, FC619 (-12 thru -32), FC639/FC839B, FC693, FC735, FC849/FC849B, GH120, GH194, GH195, GH663, GH681-6, GH781, GH793.

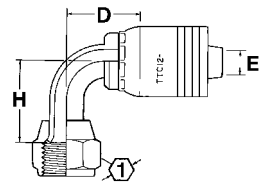

4

Global TTC12 Fittings for use with Hose: FC136, FC636, FC659, FC736, GH493.

1 Nipple Part #	2 OTC Part #	3 TTC Part #	4 TTC12 Part #	Thd.	Hose Size	A		D		EØ		H		in
						mm	in	mm	in	mm	in	mm	in	
1SA4FJC4†	1GA4FJC4†	1AA4FJC4†	—	7/16-20	-04	46,7	1.84	23,4	0.92	3,8	0.15	45,7	1.80	9/16
1SA5FJC4†	1GA5FJC4†	1AA5FJC4†	—	1/2-20	-04	48,8	1.92	25,4	1.00	4,3	0.17	45,7	1.80	5/8
1SA6FJC4	—	—	—	9/16-18	-04	45,5	1.79	22,1	0.87	4,3	0.17	55,4	2.18	11/16
1SA6FJC6	1GA6FJC6	1AA6FJC6	—	9/16-18	-06	56,4	2.22	31,2	1.23	6,1	0.24	55,4	2.18	11/16
—	—	—	1BA6FJC6	9/16-18	-06	61,5	2.42	36,1	1.42	6,1	0.24	69,3	2.73	11/16
1SA8FJC6†	—	1AA8FJC6†	—	3/4-16	-06	64,5	2.54	39,1	1.54	6,6	0.26	62,2	2.45	7/8
1SA8FJC8†	1GA8FJC8†	1AA8FJC8†	—	3/4-16	-08	68,8	2.71	39,1	1.54	9,4	0.37	62,2	2.45	7/8
—	—	—	1BA8FJC8	3/4-16	-08	72,9	2.87	43,2	1.70	9,4	0.37	84,6	3.33	7/8
1SA10FJC8†	1GA10FJC8†	1AA10FJC8†	—	7/8-14	-08	70,6	2.78	40,9	1.61	9,7	0.38	65,3	2.57	1
—	—	—	1BA10FJC8	7/8-14	-08	70,6	2.78	40,9	1.61	9,7	0.38	65,3	2.57	1
1SA10FJC10	—	1AA10FJC10	—	7/8-14	-10	68,6	2.70	39,1	1.54	11,7	0.46	65,3	2.57	1
1SA12FJC12	1GA12FJC12	1AA12FJC12	—	1 1/16-12	-12	85,3	3.36	55,1	2.17	14,7	0.58	94,0	3.70	1 1/4
—	—	—	1BA12FJC12	1 1/16-12	-12	85,6	3.37	55,4	2.18	14,2	0.56	112,0	4.41	1 1/4
1SA16FJC16	1GA16FJC16	1AA16FJC16	—	1 5/16-12	-16	90,4	3.56	55,9	2.20	19,3	0.76	116,3	4.58	1 1/2
—	—	—	1BA16FJC16	1 5/16-12	-16	103,1	4.06	68,6	2.70	19,3	0.76	133,1	5.24	1 1/2
1SA20FJC20	1GA20FJC20	—	—	1 5/8-12	-20	108,0	4.25	64,0	2.52	25,7	1.01	140,5	5.53	2
—	—	—	1BA20FJC20	1 5/8-12	-20	120,7	4.75	76,7	3.02	25,7	1.01	150,9	5.94	2
—	—	1AR20FJC20*	—	1 5/8-12	-20	108,0	4.25	64,0	2.52	25,7	1.01	140,5	5.53	2
—	—	1AV20FJC20**	—	1 5/8-12	-20	108,0	4.25	64,0	2.52	25,7	1.01	140,5	5.53	2

* Uses 1-wire braid hose socket.

**Uses 2-wire braid hose socket.

† Swivel nuts are universal for both SAE 37° and SAE 45° connections.

SPECIALTY &
TRUCK HOSE

LOW & MEDIUM
PRESSURE HOSE

HIGH PRESSURE HOSE

HOSE FITTINGS

ADAPTERS &
TUBE FITTINGS

ACCESSORIES &
ASSEMBLY INSTRUCTIONS

HOSE ASSEMBLY
EQUIPMENT

APPENDICES

Male JIC/SAE 37° (MJ)

SPECIALTY & TRUCK HOSE

LOW & MEDIUM PRESSURE HOSE

HIGH PRESSURE HOSE

HOSE FITTINGS

ADAPTERS & TUBE FITTINGS

ACCESSORIES & ASSEMBLY INSTRUCTIONS

HOSE ASSEMBLY EQUIPMENT

APPENDICES

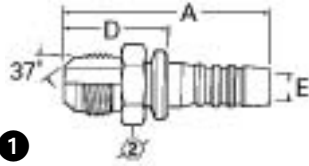

1

Global Nipples for use with Hose:
Clamp: 2661 (-12 thru -20), FC619 (-12 thru -20). **Socket 1SA:** 2681, FC194, FC211, FC310, FC510, FC639/FC839B (-4 thru -8), GH194 (-4 thru -20), GH663, GH681. **Socket 1SB:** 2781, FC195, FC212, FC466, FC498, FC598, FC579, FC639/FC839B (-10 thru -16), FC735 (-4 thru -20), FC849/FC849B (-06 thru -12), GH120 (-4 thru -20), GH195, GH781 (-04 thru -20), GH793, 2766.

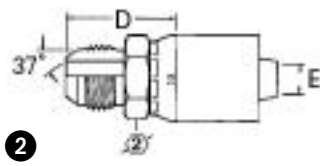

2

Global OTC Fittings for use with Hose: 2583, 2661, FC466, FC498, FC598, FC619, FC699.

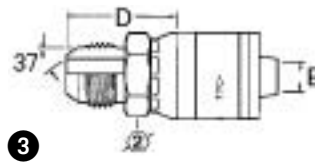

3

Global TTC Fittings for use with Hose: 2661(-12 thru -32), FC211, FC212, FC310, FC510, FC579, FC611, FC619 (-12 thru -32), FC639/FC839B, FC693, FC735, FC849/FC849B, GH120, GH194, GH195, GH663, GH681-6, GH781, GH793.

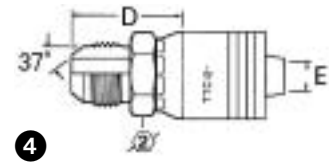

4

Global TTC12 Fittings for use with Hose: FC136, FC636, FC659, FC736, GH493.

1 Nipple Part #	2 OTC Part #	3 TTC Part #	4 TTC12 Part #	Thd.	Hose Size	A		D		EØ		in
						mm	in	mm	in	mm	in	
1SA4MJ4	1GA4MJ4	1AA4MJ4	—	7/16-20	-04	50,8	2.00	27,2	1.07	4,3	0.17	9/16
1SA5MJ4	1GA5MJ4	1AA5MJ4	—	1/2-20	-04	46,7	1.84	23,4	0.92	4,3	0.17	9/16
1SA6MJ4	1GA6MJ4	1AA6MJ4	—	9/16-18	-04	47,0	1.85	23,6	0.93	4,3	0.17	5/8
1SA5MJ5	—	—	—	1/2-20	-05	52,6	2.07	28,4	1.12	5,3	0.21	9/16
1SA6MJ5	1GA6MJ5	1AA6MJ5	—	9/16-18	-05	47,8	1.88	23,9	0.94	5,3	0.21	5/8
1SA6MJ6	1GA6MJ6	1AA6MJ6	1BA6MJ6	9/16-18	-06	54,9	2.16	29,7	1.17	6,6	0.26	11/16
1SA8MJ6	1GA8MJ6	1AA8MJ6	1BA8MJ6	3/4-16	-06	53,3	2.10	28,2	1.11	6,6	0.26	13/16
1SA8MJ8	1GA8MJ8	1AA8MJ8	1BA8MJ8	3/4-16	-08	65,3	2.57	35,8	1.41	9,7	0.38	13/16
1SA10MJ8	1GA10MJ8	1AA10MJ8	1BA10MJ8	7/8-14	-08	61,5	2.42	32,0	1.26	9,7	0.38	15/16
1SA12MJ8	1GA12MJ8	1AA12MJ8	1BA12MJ8	1 1/16-12	-08	65,8	2.59	36,1	1.42	9,7	0.38	1 1/8
1SA10MJ10	1GA10MJ10	1AA10MJ10	1BA10MJ10	7/8-14	-10	69,3	2.73	39,9	1.57	12,2	0.48	15/16
1SA12MJ10	1GA12MJ10	1AA12MJ10	1BA12MJ10	1 1/16-12	-10	65,8	2.59	36,3	1.43	12,7	0.50	1 1/8
1SA10MJ12	1GA10MJ12	1AA10MJ12	1BA10MJ12	7/8-14	-12	70,6	2.78	40,4	1.59	12,2	0.48	1 1/8
1SA12MJ12	1GA12MJ12	1AA12MJ12	1BA12MJ12	1 1/16-12	-12	74,7	2.94	44,5	1.75	15,5	0.61	1 1/8
1SA14MJ12	1GA14MJ12	1AA14MJ12	1BA14MJ12	1 3/16-12	-12	69,3	2.73	39,1	1.54	15,5	0.61	1 1/4
1SA16MJ12	1GA16MJ12	1AA16MJ12	1BA16MJ12	1 5/16-12	-12	69,9	2.75	39,6	1.56	15,5	0.61	1 3/8
1SA16MJ16	1GA16MJ16	1AA16MJ16	1BA16MJ16	1 5/16-12	-16	82,6	3.25	48,3	1.90	20,8	0.82	1 3/8
1SA20MJ20	1GA20MJ20	—	1BA20MJ20	1 5/8-12	-20	98,8	3.89	54,9	2.16	26,7	1.05	1 3/4
—	—	1AR20MJ20*	—	1 5/8-12	-20	98,8	3.89	54,9	2.16	26,7	1.05	1 3/4
—	—	1AV20MJ20**	—	1 5/8-12	-20	98,8	3.89	54,9	2.16	26,7	1.05	1 3/4
1SA24MJ24	1GA24MJ24	1AA24MJ24	1BA24MJ24	1 7/8-12	-24	109,5	4.31	63,2	2.49	32,0	1.26	2
1SA32MJ32	1GA32MJ32	1AA32MJ32	—	2 1/2-12	-32	124,2	4.89	73,9	2.91	44,5	1.75	2 5/8

* Uses 1-wire braid hose socket.

**Uses 2-wire braid hose socket.

Female SAE 45° Swivel (FS)

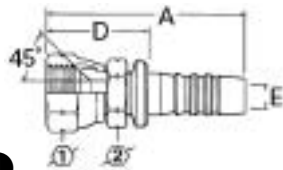

1
Global Nipples for use with Hose:
Clamp: 2661 (-12 thru -20), FC619 (-12 thru -20). **Socket 1SA:** 2681, FC194, FC211, FC310, FC510, FC639/FC839B (-4 thru -8), GH194 (-4 thru -20), GH663, GH681. **Socket 1SB:** 2781, FC195, FC212, FC466, FC498, FC598, FC579, FC639/FC839B (-10 thru -16), FC735 (-4 thru -20), FC849/FC849B (-06 thru -12), GH120 (-4 thru -20), GH195, GH781 (-04 thru -20), GH793, 2766.

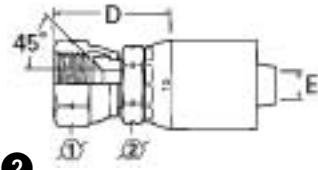

2
Global OTC Fittings for use with Hose: 2583, 2661, FC466, FC498, FC598, FC619, FC699

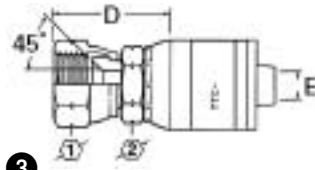

3
Global TTC Fittings for use with Hose: 2661(-12 thru -32), FC211, FC212, FC310, FC510, FC579, FC611, FC619 (-12 thru -32), FC639/FC839B, FC693, FC735, FC849/FC849B, GH120, GH194, GH195, GH663, GH681-6, GH781, GH793.

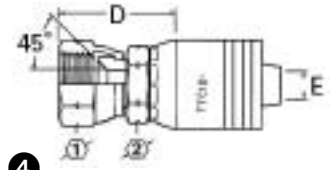

4
Global TTC12 Fittings for use with Hose: FC136, FC636, FC659, FC736, GH493.

1 Nipple Part #	2 OTC Part #	3 TTC Part #	4 TTC12 Part #	Thd.	Hose Size	A		D		EØ		1	2
						mm	in	mm	in	mm	in	in	in
1SA4FS4	1GA4FS4	1AA4FS4	—	7/16-20	-04	50,8	2.00	27,2	1.07	4,3	0.17	9/16	9/16
1SA5FS4	1GA5FS4	1AA5FS4	—	1/2-20	-04	50,3	1.98	26,9	1.06	4,3	0.17	5/8	9/16
1SA4FS6	1GA4FS6	1AA4FS6	1BA4FS6	7/16-20	-06	55,6	2.19	30,2	1.19	4,8	0.19	9/16	11/16
1SA6FS6	1GA6FS6	1AA6FS6	1BA6FS6	5/8-18	-06	58,7	2.31	33,3	1.31	6,6	0.26	3/4	11/16
1SA8FS6	1GA8FS6	1AA8FS6	1BA8FS6	3/4-16	-06	58,7	2.31	33,3	1.31	6,6	0.26	7/8	11/16
1SA8FS8	1GA8FS8	1AA8FS8	1BA8FS8	3/4-16	-08	66,8	2.63	37,1	1.46	9,7	0.38	7/8	13/16
1SA10FS8	1GA10FS8	1AA10FS8	1BA10FS8	7/8-14	-08	67,1	2.64	37,3	1.47	9,7	0.38	1	13/16
1SA10FS10	1GA10FS10	—	—	7/8-14	-10	70,4	2.77	40,9	1.61	12,7	0.50	1	15/16
1SA12FS10	—	1AA12FS10	1BA12FS10	1 1/16-14	-10	69,1	2.72	39,9	1.57	12,7	0.50	1 1/4	1 1/16
1SA12FS12	1GA12FS12	1AA12FS12	1BA12FS12	1 1/16-14	-12	72,1	2.84	41,9	1.65	15,5	0.61	1 1/4	1 1/8

Male Boss O-Ring (MB)

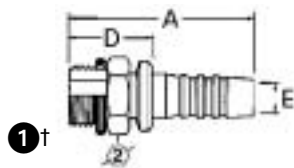

1†

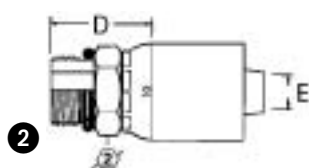

2

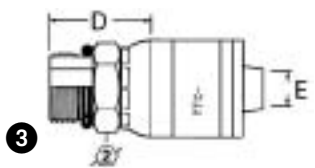

3

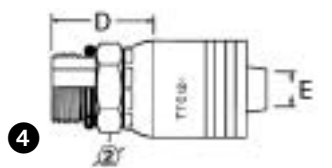

4

1† Nipple Part #	2 OTC Part #	3 TTC Part #	4 TTC12 Part #	Thd.	Hose Size	A		D		EØ		2
						mm	in	mm	in	mm	in	in
1SA4MB4	1GA4MB4	1AA4MB4	—	7/16-20	-04	46,7	1.84	23,4	0.92	4,3	0.17	9/16
1SA5MB4	1GA5MB4	1AA5MB4	—	1/2-20	-04	46,7	1.84	23,4	0.92	4,3	0.17	5/8
1SA6MB4	1GA6MB4	1AA6MB4	—	9/16-18	-04	45,2	1.78	21,8	0.86	4,3	0.17	11/16
1SA6MB6	1GA6MB6	1AA6MB6	1BA6MB6	9/16-18	-06	50,8	2.00	25,4	1.00	6,6	0.26	11/16
1SA8MB6	1GA8MB6	1AA8MB6	1BA8MB6	3/4-16	-06	50,0	1.97	24,9	0.98	6,6	0.26	7/8
1SA8MB8	1GA8MB8	1AA8MB8	1BA8MB8	3/4-16	-08	59,9	2.36	30,2	1.19	9,7	0.38	7/8
1SA10MB8	1GA10MB8	1AA10MB8	1BA10MB8	7/8-14	-08	57,4	2.26	27,7	1.09	9,7	0.38	1
1SA12MB8	1GA12MB8	1AA12MB8	1BA12MB8	1 1/16-12	-08	60,7	2.39	31,0	1.22	9,7	0.38	1 1/4
1SA10MB10	1GA10MB10	1AA10MB10	1BA10MB10	7/8-14	-10	62,7	2.47	33,3	1.31	12,7	0.50	1
1SA12MB10	1GA12MB10	1AA12MB10	1BA12MB10	1 1/16-12	-10	60,7	2.39	31,2	1.23	12,7	0.50	1 1/4
1SA12MB12	1GA12MB12	1AA12MB12	1BA12MB12	1 1/16-12	-12	62,0	2.44	31,8	1.25	15,5	0.61	1 1/4
1SA16MB12	1GA16MB12	1AA16MB12	1BA16MB12	1 5/16-12	-12	65,0	2.56	34,8	1.37	15,5	0.61	1 1/2
1SA16MB16	1GA16MB16	1AA16MB16	1BA16MB16	1 5/16-12	-16	69,6	2.74	35,3	1.39	20,8	0.82	1 1/2
1SA20MB20	1GA20MB20	—	1BA20MB20	1 5/8-12	-20	92,2	3.63	48,3	1.90	26,7	1.05	1 7/8
—	—	1AR20MB20*	—	1 5/8-12	-20	92,2	3.63	48,3	1.90	26,7	1.05	1 7/8
—	—	1AV20MB20**	—	1 5/8-12	-20	92,2	3.63	48,3	1.90	26,7	1.05	1 7/8
1SA24MB24	1GA24MB24	1AA24MB24	1BA24MB24	1 7/8-12	-24	92,2	3.63	46,0	1.81	32,0	1.26	2 1/8

* Uses 1-wire braid hose socket.
 ** Uses 2-wire braid hose socket.

† Nipples do not include O-ring. See pages 194, 195 for o-rings.

Female ORS Swivel (FR)

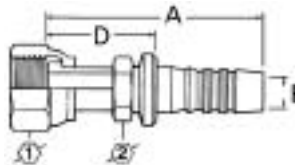

1 **Global Nipples for use with Hose:**
Clamp: 2661 (-12 thru -20), FC619 (-12 thru -20). **Socket 1SA:** 2681, FC194, FC211, FC310, FC510, FC639/FC839B (-4 thru -8), GH194 (-4 thru -20), GH663, GH681. **Socket 1SB:** 2781, FC195, FC212, FC466, FC498, FC598, FC579, FC639/FC839B (-10 thru -16), FC735 (-4 thru -20), FC849/FC849B (-06 thru -12), GH120 (-4 thru -20), GH195, GH781 (-04 thru -20), GH793, 2766.

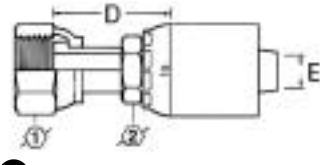

2 **Global OTC Fittings for use with Hose:** 2583, 2661, FC466, FC498, FC598, FC619, FC699

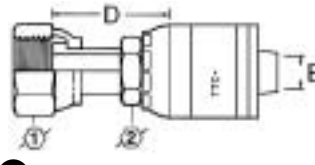

3 **Global TTC Fittings for use with Hose:** 2661(-12 thru -32), FC211, FC212, FC310, FC510, FC579, FC611, FC619 (-12 thru -32), FC639/FC839B, FC693, FC735, FC849/FC849B, GH120, GH194, GH195, GH663, GH681-6, GH781, GH793.

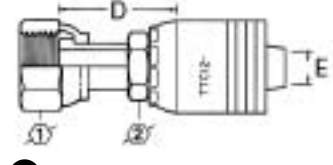

4 **Global TTC12 Fittings for use with Hose:** FC136, FC636, FC659, FC736, GH493.

1 Nipple Part #	2 OTC Part #	3 TTC Part #	4 TTC12 Part #	Thd.	Hose Size	A		D		EØ		1	2
						mm	in	mm	in	mm	in	in	in
1SA4FR4	1GA4FR4	1AA4FR4	—	9/16-18	-04	49,5	1.95	26,2	1.03	4,3	0.17	11/16	9/16
1SA6FR4	1GA6FR4	1AA6FR4	—	11/16-16	-04	51,8	2.04	28,4	1.12	4,3	0.17	13/16	5/8
1SA4FR6	1GA4FR6	1AA4FR6	1BA4FR6	9/16-18	-06	54,4	2.14	29,2	1.15	4,3	0.17	11/16	11/16
1SA6FR6	1GA6FR6	1AA6FR6	1BA6FR6	11/16-16	-06	56,6	2.23	31,5	1.24	6,6	0.26	13/16	11/16
1SA8FR6	1GA8FR6	1AA8FR6	1BA8FR6	13/16-16	-06	58,9	2.32	33,5	1.32	6,6	0.26	15/16	13/16
1SA6FR8	1GA6FR8	1AA6FR8	1BA6FR8	11/16-16	-08	63,8	2.51	34,0	1.34	6,6	0.26	13/16	7/8
1SA8FR8	1GA8FR8	1AA8FR8	1BA8FR8	13/16-16	-08	67,8	2.67	38,1	1.50	9,7	0.38	15/16	7/8
1SA10FR8	1GA10FR8	1AA10FR8	1BA10FR8	1-14	-08	67,1	2.64	37,3	1.47	9,7	0.38	11/8	15/16
1SA12FR8	1GA12FR8	1AA12FR8	1BA12FR8	13/16-12	-08	71,1	2.80	41,4	1.63	9,7	0.38	13/8	11/8
1SA8FR10	1GA8FR10	1AA8FR10	1BA8FR10	13/16-16	-10	67,8	2.67	38,4	1.51	9,7	0.38	15/16	15/16
1SA10FR10	1GA10FR10	1AA10FR10	1BA10FR10	1-14	-10	70,1	2.76	40,9	1.61	12,2	0.48	11/8	15/16
1SA12FR10	1GA12FR10	1AA12FR10	1BA12FR10	13/16-12	-10	70,9	2.79	41,4	1.63	12,7	0.50	13/8	11/8
1SA10FR12	1GA10FR12	1AA10FR12	1BA10FR12	1-14	-12	71,4	2.81	41,4	1.62	12,2	0.48	11/8	11/8
1SA12FR12	1GA12FR12	1AA12FR12	1BA12FR12	13/16-12	-12	73,9	2.91	43,7	1.72	15,5	0.61	13/8	11/8
1SA16FR12	1GA16FR12	1AA16FR12	1BA16FR12	17/16-12	-12	75,7	2.98	45,5	1.79	15,5	0.61	15/8	13/8
1SA12FR16	1GA12FR16	1AA12FR16	1BA12FR16	13/16-12	-16	81,8	3.22	47,2	1.86	15,5	0.61	13/8	13/8
1SA16FR16	1GA16FR16	1AA16FR16	1BA16FR16	17/16-12	-16	83,6	3.29	49,3	1.94	20,6	0.81	15/8	13/8
1SA20FR16	1GA20FR16	1AA20FR16	1BA20FR16	111/16-12	-16	82,6	3.25	48,3	1.90	20,6	0.81	17/8	15/8
1SA20FR20	1GA20FR20	—	1BA20FR20	111/16-12	-20	103,4	4.07	59,2	2.33	25,9	1.02	17/8	13/4
—	—	1AR20FR20*	—	111/16-12	-20	103,4	4.07	59,2	2.33	25,9	1.02	17/8	13/4
—	—	1AV20FR20**	—	111/16-12	-20	103,4	4.07	59,2	2.33	25,9	1.02	17/8	13/4
1SA24FR20	1GA24FR20	—	—	2-12	-20	98,6	3.88	54,6	2.15	26,7	1.05	21/4	113/16
—	—	1AR24FR20*	—	2-12	-20	98,6	3.88	54,6	2.15	26,7	1.05	21/4	113/16
—	—	1AV24FR20**	—	2-12	-20	98,6	3.88	54,6	2.15	26,7	1.05	21/4	113/16
—	—	—	1BA24FR20	2-12	-20	95,0	3.74	55,6	2.19	26,7	1.05	21/4	2
1SA24FR24	1GA24FR24	1AA24FR24	—	2-12	-24	102,1	4.02	55,6	2.19	32,0	1.26	21/4	2
—	—	—	1BA24FR24	2-12	-24	99,8	3.93	56,1	2.21	32,0	1.26	21/4	2

* Uses 1-wire braid hose socket.

**Uses 2-wire braid hose socket.

SPECIALTY & TRUCK HOSE
 LOW & MEDIUM PRESSURE HOSE
 HIGH PRESSURE HOSE
 HOSE FITTINGS
 ADAPTERS & TUBE FITTINGS
 ACCESSORIES & ASSEMBLY INSTRUCTIONS
 HOSE ASSEMBLY EQUIPMENT
 APPENDICES

Female ORS Swivel 45° Elbow (FRA)

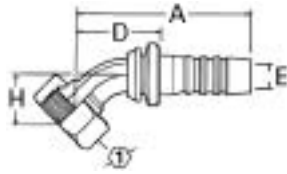

1 **Global Nipples for use with Hose:**
Clamp: 2661 (-12 thru -20), FC619 (-12 thru -20). **Socket 1SA:** 2681, FC194, FC211, FC310, FC510, FC639/FC839B (-4 thru -8), GH194 (-4 thru -20), GH663, GH681. **Socket 1SB:** 2781, FC195, FC212, FC466, FC498, FC598, FC579, FC639/FC839B (-10 thru -16), FC735 (-4 thru -20), FC849/FC849B (-06 thru -12), GH120 (-4 thru -20), GH195, GH781 (-04 thru -20), GH793, 2766.

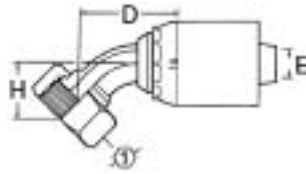

2 **Global OTC Fittings for use with Hose:** 2583, 2661, FC466, FC498, FC598, FC619, FC699

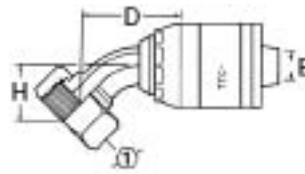

3 **Global TTC Fittings for use with Hose:** 2661(-12 thru -32), FC211, FC212, FC310, FC510, FC579, FC611, FC619 (-12 thru -32), FC639/FC839B, FC693, FC735, FC849/FC849B, GH120, GH194, GH195, GH663, GH681-6, GH781, GH793.

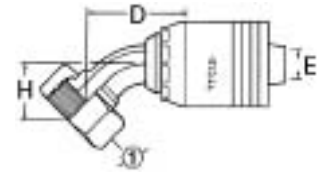

4 **Global TTC12 Fittings for use with Hose:** FC136, FC636, FC659, FC736, GH493.

1 Nipple Part #	2 OTC Part #	3 TTC Part #	4 TTC12 Part #	Thd.	Hose Size	A		D		EØ		H		1
						mm	in	mm	in	mm	in	mm	in	
1SA4FRA4	1GA4FRA4	1AA4FRA4	—	9/16-18	-04	53,8	2.12	30,5	1.20	4,3	0.17	10,2	0.40	11/16
1SA6FRA4	1GA6FRA4	1AA6FRA4	—	11/16-16	-04	58,4	2.30	35,1	1.38	4,3	0.17	10,9	0.43	13/16
1SA4FRA6	1GA4FRA6	1AA4FRA6	—	9/16-18	-06	58,4	2.30	33,0	1.30	4,3	0.17	10,4	0.41	11/16
1SA6FRA6	1GA6FRA6	1AA6FRA6	1BA6FRA6	11/16-16	-06	61,7	2.43	36,3	1.43	6,6	0.26	10,9	0.43	13/16
1SA8FRA6	1GA8FRA6	1AA8FRA6	1BA8FRA6	13/16-16	-06	69,6	2.74	44,2	1.74	6,6	0.26	15,0	0.59	15/16
1SA6FRA8	—	1AA6FRA8	—	11/16-16	-08	67,3	2.65	37,6	1.48	6,6	0.26	10,9	0.43	13/16
1SA8FRA8	1GA8FRA8	1AA8FRA8	1BA8FRA8	13/16-16	-08	75,2	2.96	45,5	1.79	9,1	0.36	15,0	0.59	15/16
1SA10FRA8	1GA10FRA8	1AA10FRA8	1BA10FRA8	1-14	-08	80,8	3.18	51,1	2.01	9,7	0.38	16,5	0.65	1 1/8
1SA12FRA8	1GA12FRA8	1AA12FRA8	—	1 3/16-12	-08	89,2	3.51	59,4	2.34	9,7	0.38	21,1	0.83	1 3/8
1SA10FRA10	1GA10FRA10	1AA10FRA10	1BA10FRA10	1-14	-10	77,5	3.05	51,1	2.01	11,4	0.45	16,5	0.65	1 1/8
1SA12FRA10	—	1AA12FRA10	—	1 3/16-12	-10	89,4	3.52	59,9	2.36	12,7	0.50	21,1	0.83	1 3/8
1SA12FRA12	1GA12FRA12	1AA12FRA12	1BA12FRA12	1 3/16-12	-12	90,7	3.57	60,5	2.38	14,0	0.55	21,1	0.83	1 3/8
1SA16FRA12	1GA16FRA12	1AA16FRA12	—	1 7/16-12	-12	102,6	4.04	72,4	2.85	15,5	0.61	23,9	0.94	1 5/8
1SA16FRA16	1GA16FRA16	1AA16FRA16	1BA16FRA16	1 7/16-12	-16	107,4	4.23	73,2	2.88	19,8	0.78	23,9	0.94	1 5/8
1SA20FRA20	1GA20FRA20	—	1BA20FRA20	1 11/16-12	-20	129,5	5.10	85,6	3.37	25,9	1.02	25,4	1.00	1 7/8
—	—	1AR20FRA20*	—	1 11/16-12	-20	129,5	5.10	85,6	3.37	25,9	1.02	25,4	1.00	1 7/8
—	—	1AV20FRA20**	—	1 11/16-12	-20	129,5	5.10	85,6	3.37	25,9	1.02	25,4	1.00	1 7/8
1SA24FRA20	1GA24FRA20	—	—	2-12	-20	139,4	5.49	95,5	3.76	25,7	1.01	27,2	1.07	2 1/4
—	—	1AR24FRA20*	—	2-12	-20	139,4	5.49	95,5	3.76	25,7	1.01	27,2	1.07	2 1/4
—	—	1AV24FRA20**	—	2-12	-20	139,4	5.49	95,5	3.76	25,7	1.01	27,2	1.07	2 1/4
1SA24FRA24	1GA24FRA24	1AA24FRA24	—	2-12	-24	115,3	4.54	68,8	2.71	32,0	1.26	27,2	1.07	2 1/4

* Uses 1-wire braid hose socket.
 **Uses 2-wire braid hose socket.

SPECIALTY & TRUCK HOSE
 LOW & MEDIUM PRESSURE HOSE
 HIGH PRESSURE HOSE
 HOSE FITTINGS
 ADAPTERS & TUBE FITTINGS
 ACCESSORIES & ASSEMBLY INSTRUCTIONS
 HOSE ASSEMBLY EQUIPMENT
 APPENDICES

Female ORS Swivel 90° Short Drop Elbow (FRB)

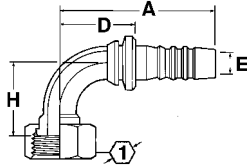

1
Global Nipples for use with Hose:
Clamp: 2661 (-12 thru -20), FC619 (-12 thru -20). **Socket 1SA:** 2681, FC194, FC211, FC310, FC510, FC639/FC839B (-4 thru -8), GH194 (-4 thru -20), GH663, GH681. **Socket 1SB:** 2781, FC195, FC212, FC466, FC498, FC598, FC579, FC639/FC839B (-10 thru -16), FC735 (-4 thru -20), FC849/FC849B (-06 thru -12), GH120 (-4 thru -20), GH195, GH781 (-04 thru -20), GH793, 2766.

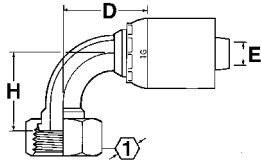

2
Global OTC Fittings for use with Hose: 2583, 2661, FC466, FC498, FC598, FC619, FC699

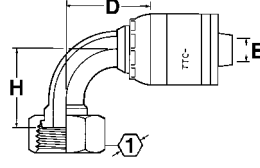

3
Global TTC Fittings for use with Hose: 2661(-12 thru -32), FC211, FC212, FC310, FC510, FC579, FC611, FC619 (-12 thru -32), FC639/FC839B, FC693, FC735, FC849/FC849B, GH120, GH194, GH195, GH663, GH681-6, GH781, GH793.

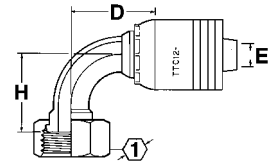

4
Global TTC12 Fittings for use with Hose: FC136, FC636, FC659, FC736, GH493.

1	2	3	4	Thd.	Hose Size	A		D		EØ		H		1
Nipple Part #	OTC Part #	TTC Part #	TTC12 Part #			mm	in	mm	in	mm	in	mm	in	in
1SA4FRB4	1GA4FRB4	1AA4FRB4	—	9/16-18	-04	53,1	2.09	29,7	1.17	4,3	0.17	20,8	0.82	11/16
1SA6FRB4	1GA6FRB4	1AA6FRB4	—	11/16-16	-04	56,4	2.22	33,0	1.30	4,3	0.17	22,9	0.90	13/16
1SA8FRB4	—	—	—	13/16-16	-04	60,2	2.37	36,8	1.45	4,3	0.17	30,2	1.19	15/16
1SA4FRB6	1GA4FRB6	1AA4FRB6	—	9/16-18	-06	56,1	2.21	30,7	1.21	4,3	0.17	20,8	0.82	11/16
1SA6FRB6	1GA6FRB6	1AA6FRB6	1BA6FRB6	11/16-16	-06	59,4	2.34	34,0	1.34	6,6	0.26	22,9	0.90	13/16
1SA8FRB6	1GA8FRB6	1AA8FRB6	1BA8FRB6	13/16-16	-06	66,5	2.62	41,4	1.62	6,6	0.26	29,2	1.15	15/16
1SA6FRB8	1GA6FRB8	1AA6FRB8	1BA6FRB8	11/16-16	-08	65,0	2.56	35,3	1.39	6,6	0.26	22,9	0.90	13/16
1SA8FRB8	1GA8FRB8	1AA8FRB8	1BA8FRB8	13/16-16	-08	72,1	2.84	42,4	1.67	9,1	0.36	29,2	1.15	15/16
1SA10FRB8	1GA10FRB8	1AA10FRB8	1BA10FRB8	1-14	-08	78,0	3.07	48,5	1.91	9,7	0.38	32,3	1.27	1 1/8
1SA12FRB8	1GA12FRB8	1AA12FRB8	1BA12FRB8	13/16-12	-08	87,6	3.45	57,9	2.28	9,7	0.38	47,8	1.88	1 3/8
1SA10FRB10	1GA10FRB10	1AA10FRB10	1BA10FRB10	1-14	-10	78,0	3.07	48,5	1.91	11,4	0.45	32,3	1.27	1 1/8
1SA12FRB10	1GA12FRB10	1AA12FRB10	1BA12FRB10	13/16-12	-10	87,4	3.44	58,2	2.29	12,7	0.50	47,8	1.88	1 3/8
1SA10FRB12	1GA10FRB12	1AA10FRB12	—	1-14	-12	79,0	3.11	49,0	1.93	11,4	0.45	32,3	1.27	1 1/8
1SA12FRB12	1GA12FRB12	1AA12FRB12	1BA12FRB12	13/16-12	-12	88,6	3.49	58,4	2.30	14,0	0.55	47,8	1.88	1 3/8
1SA16FRB12	1GA16FRB12	1AA16FRB12	1BA16FRB12	17/16-12	-12	102,6	4.04	72,4	2.85	15,5	0.61	56,1	2.21	1 5/8
1SA16FRB16	1GA16FRB16	1AA16FRB16	1BA16FRB16	17/16-12	-16	107,2	4.22	72,9	2.87	20,6	0.81	56,1	2.21	1 5/8
1SA20FRB16	1GA20FRB16	1AA20FRB16	—	1 11/16-12	-16	123,2	4.85	89,0	3.50	20,6	0.81	63,8	2.51	1 7/8
1SA20FRB20	1GA20FRB20	—	1BA20FRB20	1 11/16-12	-20	134,6	5.30	90,7	3.57	25,9	1.02	63,8	2.51	1 7/8
—	—	1AR20FRB20*	—	1 11/16-12	-20	134,6	5.30	90,7	3.57	25,9	1.02	63,8	2.51	1 7/8
—	—	1AV20FRB20**	—	1 11/16-12	-20	134,6	5.30	90,7	3.57	25,9	1.02	63,8	2.51	1 7/8
1SA24FRB24	1GA24FRB24	1AA24FRB24	—	2-12	-24	117,6	4.63	71,4	2.81	32,0	1.26	68,6	2.70	2 1/4

* Uses 1-wire braid hose socket.
**Uses 2-wire braid hose socket.

SPECIALTY & TRUCK HOSE
LOW & MEDIUM PRESSURE HOSE
HIGH PRESSURE HOSE
HOSE FITTINGS
ADAPTERS & TUBE FITTINGS
ACCESSORIES & ASSEMBLY INSTRUCTIONS
HOSE ASSEMBLY EQUIPMENT
APPENDICES

Female ORS Swivel 90° Long Drop Elbow (FRC)

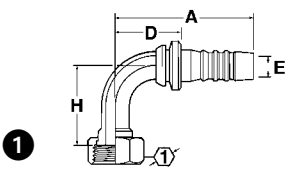

Global Nipples for use with Hose:
Clamp: 2661 (-12 thru -20), FC619 (-12 thru -20). **Socket 1SA:** 2681, FC194, FC211, FC310, FC510, FC639/FC839B (-4 thru -8), GH194 (-4 thru -20), GH663, GH681. **Socket 1SB:** 2781, FC195, FC212, FC466, FC498, FC598, FC579, FC639/FC839B (-10 thru -16), FC735 (-4 thru -20), FC849/FC849B (-06 thru -12), GH120 (-4 thru -20), GH195, GH781 (-04 thru -20), GH793, 2766.

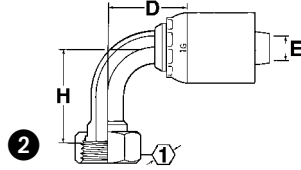

Global OTC Fittings for use with Hose: 2583, 2661, FC466, FC498, FC598, FC619, FC699

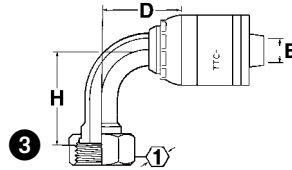

Global TTC Fittings for use with Hose: 2661(-12 thru -32), FC211, FC212, FC310, FC510, FC579, FC611, FC619 (-12 thru -32), FC639/FC839B, FC693, FC735, FC849/FC849B, GH120, GH194, GH195, GH663, GH681-6, GH781, GH793.

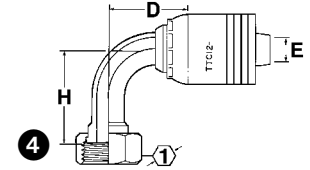

Global TTC12 Fittings for use with Hose: FC136, FC636, FC659, FC736, GH493.

1 Nipple Part #	2 OTC Part #	3 TTC Part #	4 TTC12 Part #	Thd.	Hose Size	A		D		EØ		H		1
						mm	in	mm	in	mm	in	mm	in	
1SA4FRC4	1GA4FRC4	1AA4FRC4	—	9/16-18	-04	53,1	2.09	29,7	1.17	4,3	0.17	45,7	1.80	11/16
1SA6FRC4	1GA6FRC4	1AA6FRC4	—	11/16-16	-04	56,4	2.22	33,0	1.30	4,3	0.17	54,1	2.13	13/16
1SA8FRC4	1GA8FRC4	1AA8FRC4	—	13/16-16	-04	65,8	2.59	42,4	1.67	4,3	0.17	64,8	2.55	15/16
1SA6FRC6	1GA6FRC6	1AA6FRC6	1BA6FRC6	11/16-16	-06	59,4	2.34	34,0	1.34	6,1	0.24	54,1	2.13	13/16
1SA8FRC6	1GA8FRC6	1AA8FRC6	1BA8FRC6	13/16-16	-06	68,8	2.71	43,4	1.71	6,6	0.26	64,8	2.55	15/16
1SA8FRC8	1GA8FRC8	1AA8FRC8	1BA8FRC8	13/16-16	-08	72,9	2.87	43,2	1.70	9,4	0.37	64,8	2.55	15/16
1SA10FRC8	1GA10FRC8	1AA10FRC8	—	1-14	-08	78,0	3.07	48,5	1.91	9,7	0.38	70,1	2.76	1 1/8
1SA10FRC10	1GA10FRC10	1AA10FRC10	—	1-14	-10	78,0	3.07	48,5	1.91	11,7	0.46	70,1	2.76	1 1/8
1SA12FRC12	1GA12FRC12	1AA12FRC12	1BA12FRC12	1 3/16-12	-12	88,4	3.48	58,2	2.29	14,2	0.56	96,0	3.78	1 3/8
1SA16FRC12	—	1AA16FRC12	—	1 7/16-12	-12	102,6	4.04	72,4	2.85	15,5	0.61	114,3	4.50	1 5/8
1SA16FRC16	1GA16FRC16	1AA16FRC16	1BA16FRC16	1 7/16-12	-16	107,2	4.22	72,6	2.86	19,8	0.78	114,3	4.50	1 5/8
1SA20FRC20	1GA20FRC20	—	1BA20FRC20	1 11/16-12	-20	134,6	5.30	90,7	3.57	25,7	1.01	129,3	5.09	1 7/8
—	—	1AR20FRC20*	—	1 11/16-12	-20	134,6	5.30	90,7	3.57	25,7	1.01	129,3	5.09	1 7/8
—	—	1AV20FRC20**	—	1 11/16-12	-20	134,6	5.30	90,7	3.57	25,7	1.01	129,3	5.09	1 7/8
1SA24FRC24	1GA24FRC24	1AA24FRC24	—	2-12	-24	117,6	4.63	71,4	2.81	32,0	1.26	140,7	5.54	2 1/4

Male ORS (MR)[†]

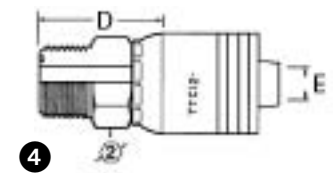
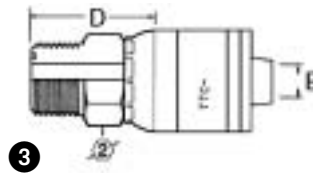
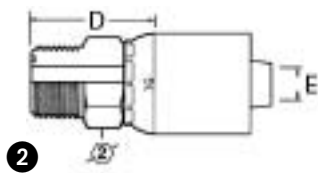
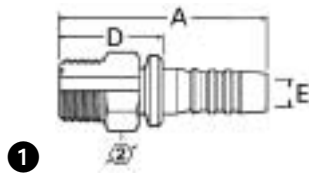

1 [†] Nipple Part #	2 [†] OTC Part #	3 [†] TTC Part #	4 [†] TTC12 Part #	Thd.	Hose Size	A		D		EØ		2
						mm	in	mm	in	mm	in	
1SA4MR4	1GA4MR4	1AA4MR4	—	9/16-18	-04	45,2	1.78	21,8	0.86	4,3	0.17	5/8
1SA6MR6	1GA6MR6	1AA6MR6	1BA6MR6	11/16-16	-06	50,5	1.99	25,1	0.99	6,6	0.26	3/4
1SA8MR6	1GA8MR6	1AA8MR6	1BA8MR6	13/16-16	-06	49,5	1.95	24,1	0.95	6,6	0.26	7/8
1SA8MR8	1GA8MR8	1AA8MR8	1BA8MR8	13/16-16	-08	58,4	2.30	28,7	1.13	9,7	0.38	7/8
1SA12MR12	1GA12MR12	1AA12MR12	1BA12MR12	1 3/16-12	-12	66,8	2.63	36,6	1.44	15,5	0.61	1 1/4
1SA16MR12	1GA16MR12	1AA16MR12	1BA16MR12	1 7/16-12	-12	64,3	2.53	34,0	1.34	15,5	0.61	1 1/2
1SA16MR16	—	—	—	1 7/16-12	-16	76,2	3.00	41,7	1.64	20,6	0.81	1 1/2

* Uses 1-wire braid hose socket.

**Uses 2-wire braid hose socket.

[†] Does not include O-ring. See pages 194, 195 for o-rings.

Male Staplok® (SL)

SPECIALTY & TRUCK HOSE

LOW & MEDIUM PRESSURE HOSE

HIGH PRESSURE HOSE

HOSE FITTINGS

ADAPTERS & TUBE FITTINGS

ACCESSORIES & ASSEMBLY INSTRUCTIONS

HOSE ASSEMBLY EQUIPMENT

APPENDICIES

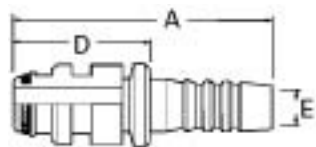

1
Global Nipples for use with Hose:
Clamp: 2661 (-12 thru -20), FC619 (-12 thru -20). **Socket 1SA:** 2681, FC194, FC211, FC310, FC510, FC639/FC839B (-4 thru -8), GH194 (-4 thru -20), GH663, GH681. **Socket 1SB:** 2781, FC195, FC212, FC466, FC498, FC598, FC579, FC639/FC839B (-10 thru -16), FC735 (-4 thru -20), FC849/FC849B (-06 thru -12), GH120 (-4 thru -20), GH195, GH781 (-04 thru -20), GH793, 2766.

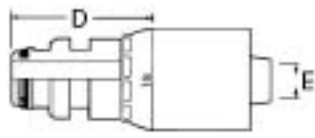

2
Global OTC Fittings for use with Hose: 2583, 2661, FC466, FC498, FC619, FC699

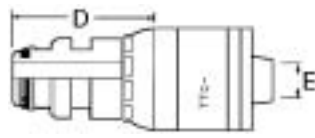

3
Global TTC Fittings for use with Hose: 2661(-12 thru -32), FC211, FC212, FC310, FC510, FC579, FC611, FC619 (-12 thru -32), FC639/FC839B, FC693, FC735, FC849/FC849B, GH120, GH194, GH195, GH663, GH681-6, GH781, GH793.

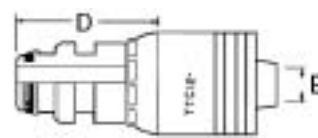

4
Global TTC12 Fittings for use with Hose: FC136, FC636, FC659, FC736, GH493.

1 Nipple Part #	2 OTC Part #	3 TTC Part #	4 TTC12 Part #	Thd.	Hose Size	A		D		EØ	
						mm	in	mm	in	mm	in
1S4SL4	1G4SL4	1A4SL4	—	—	-04	55,4	2.18	32,0	1.26	4,3	0.17
1S6SL6	1G6SL6	1A6SL6	1B6SL6	—	-06	58,4	2.30	33,0	1.30	6,6	0.26
1S8SL6	1G8SL6	1A8SL6	1B8SL6	—	-06	58,4	2.30	33,0	1.30	6,6	0.26
1S8SL8	1G8SL8	1A8SL8	1B8SL8	—	-08	64,0	2.52	34,3	1.35	9,7	0.38
1S12SL12	1G12SL12	1A12SL12	1B12SL12	—	-12	65,0	2.56	34,8	1.37	15,5	0.61
1S16SL16	1G16SL16	1A16SL16	1B16SL16	—	-16	74,9	2.95	40,6	1.60	20,6	0.81
1S20SL20	1G20SL20	—	1B20SL20	—	-20	86,4	3.40	42,4	1.67	26,7	1.05
—	—	1AP20SL20*	—	—	-20	86,4	3.40	42,4	1.67	26,7	1.05
—	—	1AT20SL20**	—	—	-20	86,4	3.40	42,4	1.67	26,7	1.05
1S32SL32	1G32SL32	1A32SL32	—	—	-32	98,3	3.87	48,0	1.89	44,5	1.75

Male SAE Inverted Flare Swivel (MF)

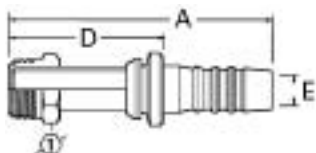

1
Nipple Part #

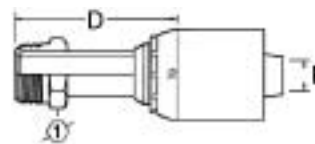

2
OTC Part #

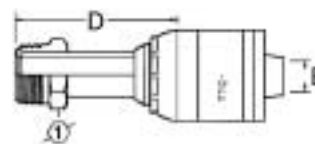

3
TTC Part #

1 Nipple Part #	2 OTC Part #	3 TTC Part #	TTC12 Part #	Thd.	Hose Size	A		D		EØ		① in
						mm	in	mm	in	mm	in	
1SA4MF3	—	—	—	7/16-24	-03	54,6	2.15	37,1	1.46	2,5	0.10	7/16
1SA3MF4	—	1AA3MF4	—	3/8-24	-04	61,5	2.42	38,1	1.50	2,5	0.10	3/8
1SA4MF4	1GA4MF4	1AA4MF4	—	7/16-24	-04	60,7	2.39	37,1	1.46	4,3	0.17	7/16
1SA5MF4	—	1AA5MF4	—	1/2-20	-04	60,7	2.39	37,1	1.46	4,3	0.17	1/2
1SA5MF6	1GA5MF6	1AA5MF6	—	1/2-20	-06	66,0	2.60	40,9	1.61	6,1	0.24	1/2
1SA4MF6	—	1AA4MF6	—	7/16-24	-06	64,3	2.53	38,9	1.53	4,3	0.17	7/16
1SA6MF6	1GA6MF6	1AA6MF6	—	5/8-18	-06	66,0	2.60	40,9	1.61	6,6	0.26	5/8
1SA8MF8	1GA8MF8	1AA8MF8	—	3/4-18	-08	70,9	2.79	41,4	1.62	9,7	0.38	3/4

* Uses 1-wire braid hose socket.

**Uses 2-wire braid hose socket.

Male SAE Inverted Flare Swivel 45° Elbow (MFA)

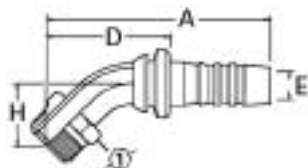

1
Global Nipples for use with Hose:
Clamp: 2661 (-12 thru -20), FC619 (-12 thru -20). **Socket 1SA:** 2681, FC194, FC211, FC310, FC510, FC639/FC839B (-4 thru -8), GH194 (-4 thru -20), GH663, GH681. **Socket 1SB:** 2781, FC195, FC212, FC466, FC498, FC598, FC579, FC639/FC839B (-10 thru -16), FC735 (-4 thru -20), FC849/FC849B (-06 thru -12), GH120 (-4 thru -20), GH195, GH781 (-04 thru -20), GH793, 2766.

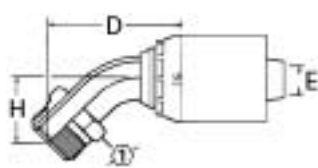

2
Global OTC Fittings for use with Hose: 2583, 2661, FC466, FC498, FC598, FC619, FC699

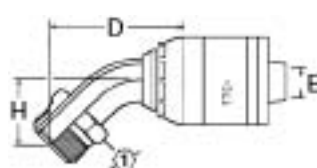

3
Global TTC Fittings for use with Hose: 2661(-12 thru -32), FC211, FC212, FC310, FC510, FC579, FC611, FC619 (-12 thru -32), FC639/FC839B, FC693, FC735, FC849/FC849B, GH120, GH194, GH195, GH663, GH681-6, GH781, GH793.

1 Nipple Part #	2 OTC Part #	3 TTC Part #	TTC12 Part #	Thd.	Hose Size	A		D		EØ		H		1
						mm	in	mm	in	mm	in	mm	in	in
1SA4MFA4	1GA4MFA4	1AA4MFA4	—	7/16-24	-04	67,8	2.67	44,5	1.75	4,3	0.17	24,4	0.96	7/16
1SA4MFA6	—	1AA4MFA6	—	7/16-24	-06	71,4	2.81	46,0	1.81	4,3	0.17	24,4	0.96	7/16
1SA5MFA6	1GA5MFA6	1AA5MFA6	—	1/2-20	-06	73,2	2.88	48,0	1.89	6,1	0.24	24,4	0.96	1/2
1SA6MFA6	1GA6MFA6	1AA6MFA6	—	5/8-18	-06	73,2	2.88	48,0	1.89	6,6	0.26	24,4	0.96	5/8
1SA8MFA8	1GA8MFA8	1AA8MFA8	—	3/4-18	-08	78,0	3.07	48,3	1.90	9,7	0.38	23,6	0.93	3/4

Male SAE Inverted Flare Swivel 90° Elbow (MFB)

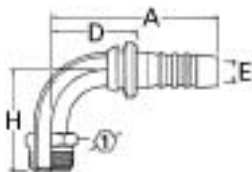

1
Global Nipples for use with Hose:
Clamp: 2661 (-12 thru -20), FC619 (-12 thru -20). **Socket 1SA:** 2681, FC194, FC211, FC310, FC510, FC639/FC839B (-4 thru -8), GH194 (-4 thru -20), GH663, GH681. **Socket 1SB:** 2781, FC195, FC212, FC466, FC498, FC598, FC579, FC639/FC839B (-10 thru -16), FC735 (-4 thru -20), FC849/FC849B (-06 thru -12), GH120 (-4 thru -20), GH195, GH781 (-04 thru -20), GH793, 2766.

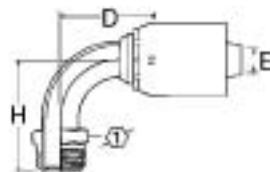

2
Global OTC Fittings for use with Hose: 2583, 2661, FC466, FC498, FC598, FC619, FC699

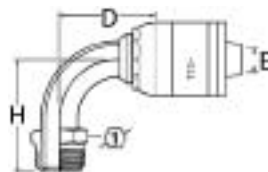

3
Global TTC Fittings for use with Hose: 2661(-12 thru -32), FC211, FC212, FC310, FC510, FC579, FC611, FC619 (-12 thru -32), FC639/FC839B, FC693, FC735, FC849/FC849B, GH120, GH194, GH195, GH663, GH681-6, GH781, GH793.

1 Nipple Part #	2 OTC Part #	3 TTC Part #	TTC12 Part #	Thd. Flange Head Ø	Hose Size	A		D		EØ		H		1
						mm	in	mm	in	mm	in	mm	in	in
1SA4MFB4	1GA4MFB4	1AA4MFB4	—	7/16-24	-04	58,2	2.29	34,8	1.37	4,3	0.17	42,3	1.69	7/16
1SA5MFB4	—	1AA5MFB4	—	1/2-20	-04	58,2	2.29	34,8	1.37	4,3	0.17	43,9	1.73	1/2
1SA4MFB6	—	1AA4MFB6	—	7/16-24	-06	61,7	2.43	36,6	1.44	4,3	0.17	42,3	1.69	7/16
1SA5MFB6	1GA5MFB6	1AA5MFB6	—	1/2-20	-06	63,8	2.51	38,4	1.51	6,1	0.24	43,9	1.73	1/2
1SA6MFB6	1GA6MFB6	1AA6MFB6	—	5/8-18	-06	63,8	2.51	38,4	1.51	6,6	0.26	43,9	1.73	5/8
1SA8MFB8	1GA8MFB8	1AA8MFB8	—	3/4-18	-08	69,3	2.73	39,6	1.56	9,7	0.38	44,5	1.75	3/4

SAE Code 61 Split Flange (FL)

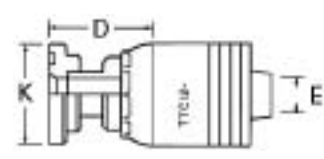
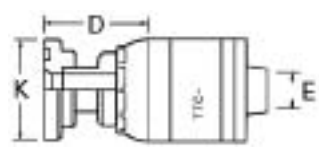
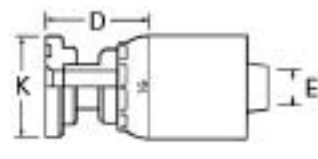
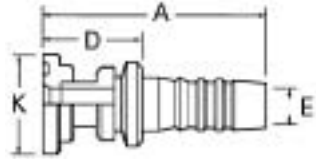

1 Global Nipples for use with Hose:
Clamp: 2661 (-12 thru -20), FC619 (-12 thru -20). **Socket 1SA:** 2681, FC194, FC211, FC310, FC510, FC639/FC839B (-4 thru -8), GH194 (-4 thru -20), GH663, GH681. **Socket 1SB:** 2781, FC195, FC212, FC466, FC498, FC598, FC579, FC639/FC839B (-10 thru -16), FC735 (-4 thru -20), FC849/FC849B (-06 thru -12), GH120 (-4 thru -20), GH195, GH781 (-04 thru -20), GH793, 2766.

2 Global OTC Fittings for use with Hose: 2583, 2661, FC466, FC498, FC598, FC619, FC699

3 Global TTC Fittings for use with Hose: 2661(-12 thru -32), FC211, FC212, FC310, FC510, FC579, FC611, FC619 (-12 thru -32), FC639/FC839B, FC693, FC735, FC849/FC849B, GH120, GH194, GH195, GH663, GH681-6, GH781, GH793.

4 Global TTC12 Fittings for use with Hose: FC136, FC636, FC659, FC736, GH493.

1 Nipple Part #	2 OTC Part #	3 TTC Part #	4 TTC12 Part #	Thd. Flange Head Ø	Hose Size	A		D		EØ	
						mm	in	mm	in	mm	in
1S8FL8	1G8FL8	1A8FL8	1B8FL8	1.19	-08	82,0	3.23	52,3	2.06	9,7	0.38
1S12FL8	1G12FL8	1A12FL8	1B12FL8	1.50	-08	83,1	3.27	53,3	2.10	9,7	0.38
1S12FL10	1G12FL10	1A12FL10	1B12FL10	1.50	-10	82,8	3.26	53,3	2.10	12,7	0.50
1S12FL12	1G12FL12	1A12FL12	1B12FL12	1.50	-12	84,1	3.31	53,8	2.12	15,5	0.61
1S16FL12	1G16FL12	1A16FL12	1B16FL12	1.75	-12	84,1	3.31	53,8	2.12	15,5	0.61
1S20FL12	1G20FL12	1A20FL12	1B20FL12	2.00	-12	91,7	3.61	61,5	2.42	15,5	0.61
1S12FL16	—	1A12FL16	—	1.50	-16	89,0	3.50	54,4	2.14	14,7	0.58
1S16FL16	1G16FL16	1A16FL16	1B16FL16	1.75	-16	88,6	3.49	54,4	2.14	20,8	0.82
1S20FL16	1G20FL16	1A20FL16	1B20FL16	2.00	-16	96,3	3.79	62,0	2.44	20,8	0.82
1S24FL16	1G24FL16	1A24FL16	1B24FL16	2.38	-16	97,3	3.83	62,7	2.47	20,8	0.82
1S16FL20	1G16FL20	—	1B16FL20	1.75	-20	100,1	3.94	56,1	2.21	20,8	0.82
—	—	1AP16FL20*	—	1.75	-20	100,1	3.94	56,1	2.21	20,8	0.82
—	—	1AT16FL20**	—	1.75	-20	100,1	3.94	56,1	2.21	20,8	0.82
1S20FL20	1G20FL20	—	1B20FL20	2.00	-20	107,7	4.24	63,8	2.51	26,7	1.05
—	—	1AP20FL20*	—	2.00	-20	107,7	4.24	63,8	2.51	26,7	1.05
—	—	1AT20FL20**	—	2.00	-20	107,7	4.24	63,8	2.51	26,7	1.05
1S24FL20	1G24FL20	—	1B24FL20	2.38	-20	108,5	4.27	64,5	2.54	26,7	1.05
—	—	1AP24FL20*	—	2.38	-20	108,5	4.27	64,5	2.54	26,7	1.05
—	—	1AT24FL20**	—	2.38	-20	108,5	4.27	64,5	2.54	26,7	1.05
1S32FL20	1G32FL20	—	1B32FL20	2.81	-20	108,5	4.27	64,5	2.54	25,7	1.01
—	—	1AP32FL20*	—	2.81	-20	108,5	4.27	64,5	2.54	25,7	1.01
—	—	1AT32FL20**	—	2.81	-20	108,5	4.27	64,5	2.54	25,7	1.01
1S20FL24	1G20FL24	1A20FL24	—	2.00	-24	111,0	4.37	64,8	2.55	26,7	1.05
1S24FL24	1G24FL24	1A24FL24	1B24FL24	2.38	-24	111,8	4.40	65,5	2.58	32,0	1.26
1S32FL24	1G32FL24	1A32FL24	1B32FL24	2.81	-24	111,8	4.40	65,5	2.58	30,2	1.19
1S24FL32	1G24FL32	1A24FL32	—	2.38	-32	117,1	4.61	66,8	2.63	32,0	1.26
—	—	—	1B24FL32	2.38	-32	129,8	5.11	66,8	2.63	28,4	1.12
1S32FL32	1G32FL32	1A32FL32	—	2.81	-32	117,1	4.61	66,8	2.63	44,5	1.75
—	—	—	1B32FL32	2.81	-32	129,8	5.11	66,8	2.63	41,4	1.62
1S40FL32	1G40FL32	1A40FL32	—	3.31	-32	116,8	4.60	66,8	2.63	44,5	1.75
—	—	—	1B40FL32	3.31	-32	129,8	5.11	66,8	2.63	41,4	1.62

For flanges, split flange halves, kits and o-rings, see pages 190-195.

* Uses 1-wire braid hose socket.

**Uses 2-wire braid hose socket.

SPECIALTY & TRUCK HOSE
 LOW & MEDIUM PRESSURE HOSE
 HIGH PRESSURE HOSE
 HOSE FITTINGS
 ADAPTERS & TUBE FITTINGS
 ACCESSORIES & ASSEMBLY INSTRUCTIONS
 HOSE ASSEMBLY EQUIPMENT
 APPENDICES

SAE Code 61 Split Flange 45° Elbow (FLA)

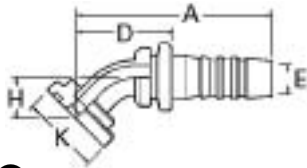

1

Global Nipples for use with Hose:
Clamp: 2661 (-12 thru -20), FC619 (-12 thru -20). **Socket 1SA:** 2681 (-12 thru -20), FC211, FC310, FC510, FC639/FC839B (-4 thru -8), GH194 (-4 thru -20), GH663, GH681. **Socket 1SB:** 2781, FC195, FC212, FC466, FC498, FC598, FC579, FC639/FC839B (-10 thru -16), FC735 (-4 thru -20), FC849/FC849B (-06 thru -12), GH120 (-4 thru -20), GH195, GH781 (-04 thru -20), GH793, 2766.

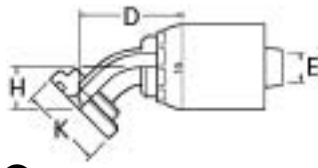

2

Global OTC Fittings for use with Hose: 2583, 2661, FC466, FC498, FC598, FC619, FC699

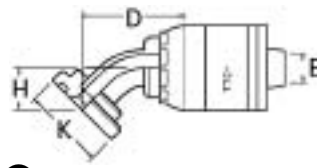

3

Global TTC Fittings for use with Hose: 2661(-12 thru -32), FC211, FC212, FC310, FC510, FC579, FC611, FC619 (-12 thru -32), FC639/FC839B, FC693, FC735, FC849/FC849B, GH120, GH194, GH195, GH663, GH681-6, GH781, GH793.

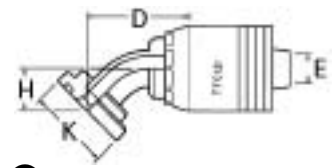

4

Global TTC12 Fittings for use with Hose: FC136, FC636, FC659, FC736, GH493.

1 Nipple Part #	2 OTC Part #	3 TTC Part #	4 TTC12 Part #	Flange Head Ø	Hose Size	A		D		EØ		H	
						mm	in	mm	in	mm	in	mm	in
1S8FLA8	1G8FLA8	1A8FLA8	—	1.19	-08	79,0	3.11	49,3	1.94	9,4	0.37	19,8	0.78
—	—	—	1B8FLA8	1.19	-08	79,5	3.13	49,8	1.96	9,4	0.37	19,8	0.78
1S12FLA8	1G12FLA8	1A12FLA8	—	1.50	-08	92,5	3.64	62,7	2.47	9,4	0.37	25,4	1.00
—	—	—	1B12FLA8	1.50	-08	93,0	3.66	63,5	2.50	9,4	0.37	25,4	1.00
1S12FLA10	1G12FLA10	1A12FLA10	—	1.50	-10	93,5	3.68	64,3	2.53	11,7	0.46	25,4	1.00
—	—	—	1B12FLA10	1.50	-10	91,9	3.62	62,5	2.46	12,7	0.50	25,4	1.00
1S12FLA12	1G12FLA12	1A12FLA12	—	1.50	-12	93,2	3.67	63,0	2.48	14,7	0.58	25,7	1.01
—	—	—	1B12FLA12	1.50	-12	93,0	3.66	62,5	2.46	14,2	0.56	25,4	1.00
1S16FLA12	1G16FLA12	1A16FLA12	—	1.75	-12	105,7	4.16	75,4	2.97	14,7	0.58	26,9	1.06
—	—	—	1B16FLA12	1.75	-12	105,7	4.16	75,4	2.97	14,2	0.56	26,9	1.06
—	—	—	1B20FLA12	2.00	-12	93,0	3.66	62,5	2.46	14,2	0.56	25,4	1.00
1S12FLA16	—	1A12FLA16	—	1.50	-16	99,8	3.93	65,3	2.57	14,7	0.58	25,7	1.01
1S16FLA16	1G16FLA16	1A16FLA16	1B16FLA16	1.75	-16	110,5	4.35	76,2	3.00	19,3	0.76	26,9	1.06
1S20FLA16	1G20FLA16	1A20FLA16	—	2.00	-16	122,2	4.81	87,6	3.45	19,3	0.76	29,2	1.15
—	—	—	1B20FLA16	2.00	-16	122,2	4.81	87,9	3.46	19,3	0.76	29,2	1.15
1S16FLA20	1G16FLA20	—	1B16FLA20	1.75	-20	121,9	4.80	77,7	3.06	19,3	0.76	26,9	1.06
—	—	1AP16FLA20*	—	1.75	-20	121,9	4.80	77,7	3.06	19,3	0.76	26,9	1.06
—	—	1AT16FLA20**	—	1.75	-20	121,9	4.80	77,7	3.06	19,3	0.76	26,9	1.06
1S20FLA20	1G20FLA20	—	—	2.00	-20	134,1	5.28	90,2	3.55	25,7	1.01	30,0	1.18
—	—	—	1B20FLA20	2.00	-20	133,6	5.26	89,4	3.52	25,7	1.01	29,2	1.15
—	—	1AP20FLA20*	—	2.00	-20	134,1	5.28	90,2	3.55	25,7	1.01	30,0	1.18
—	—	1AT20FLA20**	—	2.00	-20	134,1	5.28	90,2	3.55	25,7	1.01	30,0	1.18
1S24FLA20	1G24FLA20	—	1B24FLA20	2.37	-20	150,9	5.94	106,7	4.20	25,7	1.01	35,8	1.41
—	—	1AP24FLA20*	—	2.37	-20	150,9	5.94	106,7	4.20	25,7	1.01	35,8	1.41
—	—	1AT24FLA20**	—	2.37	-20	150,9	5.94	106,7	4.20	25,7	1.01	35,8	1.41
1S20FLA24	1G20FLA24	1A20FLA24	—	2.00	-24	115,3	4.54	69,1	2.72	32,0	1.26	27,4	1.08
1S24FLA24	1G24FLA24	1A24FLA24	—	2.37	-24	154,2	6.07	108,0	4.25	32,0	1.26	35,8	1.41
—	—	—	1B24FLA24	2.37	-24	154,2	6.07	108,0	4.25	30,2	1.19	35,8	1.41
1S32FLA24	—	1A32FLA24	—	2.81	-24	154,2	6.07	108,0	4.25	32,0	1.26	35,8	1.41
—	—	—	1B32FLA24	2.81	-24	185,4	7.30	138,9	5.47	30,2	1.19	50,8	2.00
1S24FLA32	1G24FLA32	1A24FLA32	—	2.37	-32	159,3	6.27	109,0	4.29	32,0	1.26	35,8	1.41
1S32FLA32	1G32FLA32	1A32FLA32	—	2.81	-32	190,2	7.49	140,2	5.52	44,5	1.75	50,8	2.00
—	—	—	1B32FLA32	2.81	-32	191,3	7.53	128,3	5.05	41,4	1.62	50,8	2.00
1S40FLA32	1G40FLA32	1A40FLA32	—	3.31	-32	133,9	5.27	83,6	3.29	44,5	1.75	33,0	1.30

For flanges, split flange halves, kits and o-rings, see pages 190-195.

*Uses 1-wire braid hose socket.

**Uses 2-wire braid hose socket.

SAE Code 61 Split Flange 90° Elbow (FLB)

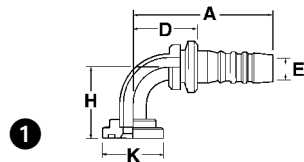

1 Global Nipples for use with Hose:
Clamp: 2661 (-12 thru -20), FC619 (-12 thru -20). **Socket 1SA:** 2681, FC194, FC211, FC310, FC510, FC639/FC839B (-4 thru -8), GH194 (-4 thru -20), GH663, GH681. **Socket 1SB:** 2781, FC195, FC212, FC466, FC498, FC598, FC579, FC639/FC839B (-10 thru -16), FC735 (-4 thru -20), FC849/FC849B (-06 thru -12), GH120 (-4 thru -20), GH195, GH781 (-04 thru -20), GH793, 2766.

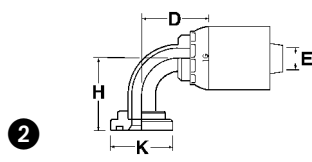

2 Global OTC Fittings for use with Hose: 2583, 2661, FC466, FC498, FC598, FC619, FC699

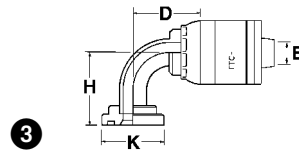

3 Global TTC Fittings for use with Hose: 2661(-12 thru -32), FC211, FC212, FC310, FC510, FC579, FC611, FC619 (-12 thru -32), FC639/FC839B, FC693, FC735, FC849/FC849B, GH120, GH194, GH195, GH663, GH681-6, GH781, GH793.

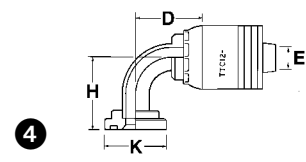

4 Global TTC12 Fittings for use with Hose: FC136, FC636, FC659, FC736, GH493.

1 Nipple Part #	2 OTC Part #	3 TTC Part #	4 TTC12 Part #	Flange Head Ø	Hose Size	A		D		EØ		H	
						mm	in	mm	in	mm	in	mm	in
1S8FLB8	1G8FLB8	1A8FLB8	—	1.19	-08	72,6	2.86	42,3	1.69	9,4	0.37	41,4	1.63
—	—	—	1B8FLB8	1.19	-08	72,9	2.87	43,2	1.70	9,4	0.37	41,4	1.63
1S12FLB8	1G12FLB8	1A12FLB8	—	1.50	-08	87,6	3.45	57,9	2.28	9,4	0.37	54,1	2.13
—	—	—	1B12FLB8	1.50	-08	85,9	3.38	56,1	2.21	9,4	0.37	54,1	2.13
1S12FLB10	1G12FLB10	1A12FLB10	—	1.50	-10	87,4	3.44	58,2	2.29	12,7	0.50	54,1	2.13
—	—	—	1B12FLB10	1.50	-10	87,9	3.46	58,4	2.30	12,7	0.50	54,1	2.13
1S12FLB12	1G12FLB12	1A12FLB12	—	1.50	-12	88,6	3.49	58,4	2.30	14,7	0.58	54,1	2.13
—	—	—	1B12FLB12	1.50	-12	88,6	3.49	58,4	2.30	14,2	0.56	54,1	2.13
1S16FLB12	1G16FLB12	1A16FLB12	—	1.75	-12	102,4	4.03	72,1	2.84	14,7	0.58	60,5	2.38
—	—	—	1B16FLB12	1.75	-12	102,4	4.03	72,1	2.84	14,2	0.56	60,5	2.38
1S20FLB12	—	1A20FLB12	—	2.00	-12	118,6	4.67	88,4	3.48	14,7	0.58	66,5	2.62
—	—	—	1B20FLB12	2.00	-12	88,6	3.49	58,4	2.30	14,2	0.56	66,5	2.62
1S12FLB16	1G12FLB16	1A12FLB16	—	1.50	-16	106,7	4.20	72,4	2.85	19,3	0.76	55,1	2.17
1S16FLB16	1G16FLB16	1A16FLB16	—	1.75	-16	107,2	4.22	72,6	2.86	19,3	0.76	60,5	2.38
—	—	—	1B16FLB16	1.75	-16	107,2	4.22	72,9	2.87	19,3	0.76	60,5	2.38
1S20FLB16	1G20FLB16	1A20FLB16	—	2.00	-16	123,2	4.85	89,0	3.50	19,3	0.76	66,5	2.62
—	—	—	1B20FLB16	2.00	-16	123,4	4.86	89,0	3.50	19,3	0.76	66,5	2.62
1S24FLB16	1G24FLB16	1A24FLB16	1B24FLB16	2.37	-16	142,0	5.59	107,7	4.24	19,3	0.76	79,2	3.12
1S16FLB20	1G16FLB20	—	1B16FLB20	1.75	-20	118,4	4.66	74,4	2.93	19,3	0.76	60,5	2.38
—	—	1AP16FLB20*	—	1.75	-20	118,4	4.66	74,4	2.93	19,3	0.76	60,5	2.38
—	—	1AT16FLB20**	—	1.75	-20	118,4	4.66	74,4	2.93	19,3	0.76	60,5	2.38
1S20FLB20	1G20FLB20	—	1B20FLB20	2.00	-20	134,6	5.30	90,7	3.57	25,7	1.01	66,5	2.62
—	—	1AP20FLB20*	—	2.00	-20	134,6	5.30	90,7	3.57	25,7	1.01	66,5	2.62
—	—	1AT20FLB20**	—	2.00	-20	134,6	5.30	90,7	3.57	25,7	1.01	66,5	2.62
1S24FLB20	1G24FLB20	—	1B24FLB20	2.37	-20	153,4	6.04	109,5	4.31	25,7	1.01	79,2	3.12
—	—	1AP24FLB20*	—	2.37	-20	153,4	6.04	109,5	4.31	25,7	1.01	79,2	3.12
—	—	1AT24FLB20**	—	2.37	-20	153,4	6.04	109,5	4.31	25,7	1.01	79,2	3.12
1S32FLB20	1G32FLB20	—	—	2.81	-20	108,0	4.25	64,0	2.52	25,7	1.01	65,0	2.56
1S16FLB24	1G16FLB24	1A16FLB24	—	1.75	-24	121,9	4.80	75,4	2.97	19,3	0.76	60,5	2.38
—	—	—	1B16FLB24	1.75	-24	121,4	4.78	75,2	2.96	19,3	0.76	60,2	2.37
1S20FLB24	1G20FLB24	1A20FLB24	—	2.00	-24	137,9	5.43	91,7	3.61	25,7	1.01	66,5	2.62
1S24FLB24	1G24FLB24	1A24FLB24	—	2.37	-24	157,0	6.18	110,5	4.35	32,0	1.26	79,2	3.12
—	—	—	1B24FLB24	2.37	-24	157,0	6.18	110,5	4.35	30,2	1.19	79,2	3.12
1S32FLB24	1G32FLB24	1A32FLB24	—	2.81	-24	184,9	7.28	138,4	5.45	32,0	1.26	114,3	4.50
—	—	—	1B32FLB24	2.81	-24	184,9	7.28	138,4	5.45	30,2	1.19	114,3	4.50
1S24FLB32	—	1A24FLB32	—	2.37	-32	161,8	6.37	111,8	4.40	32,0	1.26	79,2	3.12
—	—	—	1B24FLB32	2.37	-32	174,0	6.85	111,0	4.37	28,4	1.12	79,2	3.12
1S32FLB32	1G32FLB32	1A32FLB32	—	2.81	-32	189,7	7.47	139,4	5.49	44,5	1.75	114,3	4.50
—	—	—	1B32FLB32	2.81	-32	182,9	7.20	119,9	4.72	41,4	1.62	114,3	4.50
1S40FLB32	1G40FLB32	1A40FLB32	—	3.31	-32	189,7	7.47	139,4	5.49	44,5	1.75	115,8	4.56
—	—	—	1B40FLB32	3.31	-32	182,9	7.20	119,9	4.72	41,4	1.62	115,8	4.56

For flanges, split flange halves, kits and o-rings, see pages 190-195.

*Uses 1-wire braid hose socket.

**Uses 2-wire braid hose socket.

SAE Code 61 Split Flange 22¹/₂° Elbow (FLD)

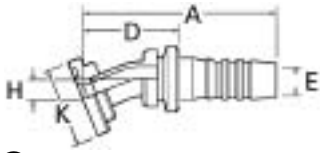

1
Global Nipples for use with Hose:
Clamp: 2661 (-12 thru -20), FC619 (-12 thru -20). **Socket 1SA:** 2681, FC194, FC211, FC310, FC510, FC639/FC839B (-4 thru -8), GH194 (-4 thru -20), GH663, GH681. **Socket 1SB:** 2781, FC195, FC212, FC466, FC498, FC598, FC579, FC639/FC839B (-10 thru -16), FC735 (-4 thru -20), FC849/FC849B (-06 thru -12), GH120 (-4 thru -20), GH195, GH781 (-04 thru -20), GH793, 2766.

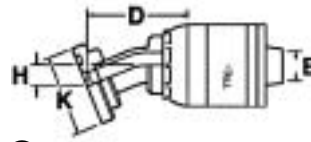

3
Global TTC Fittings for use with Hose: 2661(-12 thru -32), FC211, FC212, FC310, FC510, FC579, FC611, FC619 (-12 thru -32), FC639/FC839B, FC693, FC735, FC849/FC849B, GH120, GH194, GH195, GH663, GH681-6, GH781, GH793.

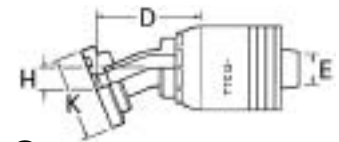

4
Global TTC12 Fittings for use with Hose: FC136, FC636, FC659, FC736, GH493.

1 Nipple Part #	2 OTC Part #	3 TTC Part #	4 TTC12 Part #	Flange Head Ø	Hose Size	A		D		EØ		H	
						mm	in	mm	in	mm	in	mm	in
—	—	—	1B8FLD8	1.19	-08	85,9	3.38	55,9	2.20	9,4	0.37	9,1	0.36
—	—	—	1B12FLD8	1.50	-08	100,8	3.97	71,1	2.80	9,4	0.37	11,2	0.44
—	—	—	1B12FLD12	1.50	-12	101,9	4.01	71,6	2.82	14,2	0.56	11,2	0.44
—	—	—	1B16FLD12	1.75	-12	113,0	4.45	82,8	3.26	14,2	0.56	11,4	0.45
1S16FLD16	—	1A16FLD16	1B16FLD16	1.75	-16	117,9	4.64	83,6	3.29	19,3	0.76	11,4	0.45
1S20FLD16	—	1A20FLD16	1B20FLD16	2.00	-16	130,0	5.12	95,8	3.77	19,3	0.76	11,7	0.46
1S20FLD20	—	—	1B20FLD20	2.00	-20	141,5	5.57	97,3	3.83	25,7	1.01	11,7	0.46
—	—	1AP20FLD20*	—	2.00	-20	141,5	5.57	97,3	3.83	25,7	1.01	11,7	0.46
—	—	1AT20FLD20**	—	2.00	-20	141,5	5.57	97,3	3.83	25,7	1.01	11,7	0.46
—	—	—	1B24FLD20	2.37	-20	160,3	6.31	116,3	4.58	25,7	1.01	14,2	0.56
—	—	—	1B24FLD24	2.37	-24	163,8	6.45	117,6	4.63	30,2	1.19	14,2	0.56
—	—	—	1B32FLD32	2.81	-32	54,1	2.13	117,9	4.64	41,4	1.62	22,4	0.88

For flanges, split flange halves, kits and o-rings, see pages 190-195.

SAE Code 61 Split Flange 67¹/₂° Elbow (FLE)

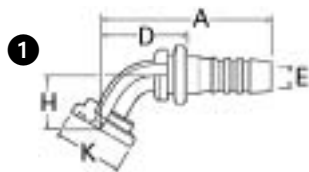

1 Nipple Part #	2 OTC Part #	3 TTC Part #	4 TTC12 Part #	Flange Head Ø	Hose Size	A		D		EØ		H	
						mm	in	mm	in	mm	in	mm	in
—	—	—	1B8FLE8	1.19	-08	86,4	3.40	56,9	2.24	9,4	0.37	32,3	1.27
—	—	—	1B12FLE12	1.50	-12	107,2	4.22	77,2	3.04	14,2	0.56	40,4	1.59
—	—	—	1B16FLE12	1.75	-12	122,9	4.84	92,7	3.65	14,2	0.56	44,2	1.74
—	—	—	1B16FLE16	1.75	-16	127,8	5.03	93,2	3.67	19,3	0.76	44,2	1.74
—	—	—	1B20FLE16	2.00	-16	145,5	5.73	111,3	4.38	19,3	0.76	46,5	1.83
—	—	1AP20FLE20*	—	2.00	-20	157,0	6.18	112,8	4.44	25,7	1.01	46,5	1.83
—	—	1AT20FLE20**	—	2.00	-20	157,0	6.18	112,8	4.44	25,7	1.01	46,5	1.83
1S20FLE20	—	—	1B20FLE20	2.00	-20	157,0	6.18	112,8	4.44	25,7	1.01	46,5	1.83
—	—	—	1B24FLE24	2.37	-24	183,1	7.21	136,9	5.39	30,2	1.19	54,4	2.14
—	—	—	1B32FLE32	2.81	-32	192,3	7.57	129,0	5.08	41,4	1.62	82,6	3.25

For flanges, split flange halves, kits and o-rings, see pages 190-195.

*Uses 1-wire braid hose socket.

**Uses 2-wire braid hose socket.

SPECIALTY & TRUCK HOSE
LOW & MEDIUM PRESSURE HOSE
HIGH PRESSURE HOSE
HOSE FITTINGS
ADAPTERS & TUBE FITTINGS
ACCESSORIES & ASSEMBLY INSTRUCTIONS
HOSE ASSEMBLY EQUIPMENT
APPENDICES

SAE Code 61 Split Flange 30° Elbow (FLF)

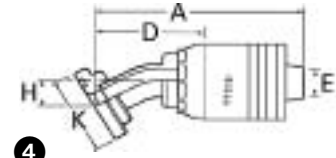

- 1** **Global Nipples for use with Hose:**
Clamp: 2661 (-12 thru -20), FC619 (-12 thru -20). **Socket 1SA:** 2681, FC194, FC211, FC310, FC510, FC639/FC839B (-4 thru -8), GH194 (-4 thru -20), GH663, GH681. **Socket 1SB:** 2781, FC195, FC212, FC466, FC498, FC598, FC579, FC639/FC839B (-10 thru -16), FC735 (-4 thru -20), FC849/FC849B (-06 thru -12), GH120 (-4 thru -20), GH195, GH781 (-04 thru -20), GH793, 2766.
- 2** **Global OTC Fittings for use with Hose:** 2583, 2661, FC466, FC498, FC598, FC619, FC699
- 3** **Global TTC Fittings for use with Hose:** 2661(-12 thru -32), FC211, FC212, FC310, FC510, FC579, FC611, FC619 (-12 thru -32), FC639/FC839B, FC693, FC735, FC849/FC849B, GH120, GH194, GH195, GH663, GH681-6, GH781, GH793.
- 4** **Global TTC12 Fittings for use with Hose:** FC136, FC636, FC659, FC736, GH493.

1 Nipple Part #	2 OTC Part #	3 TTC Part #	4 TTC12 Part #	Flange Head Ø	Hose Size	A		D		EØ		H	
						mm	in	mm	in	mm	in	mm	in
—	—	—	1B8FLF8	1.19	-08	84,3	3.32	54,6	2.15	9,4	0.37	12,7	0.50
—	—	—	1B12FLF12	1.50	-12	100,1	3.94	69,9	2.75	14,2	0.56	15,7	0.62
—	—	—	1B16FLF12	1.75	-12	111,3	4.38	81,0	3.19	14,2	0.56	16,3	0.64
—	—	—	1B16FLF16	1.75	-16	116,1	4.57	81,8	3.22	19,3	0.76	16,3	0.64
—	—	—	1B20FLF16	2.00	-16	128,0	5.04	93,7	3.69	19,3	0.76	17,0	0.67
—	—	—	1B20FLF20	2.00	-20	139,4	5.49	95,5	3.76	25,7	1.01	17,0	0.67
—	—	—	1B24FLF20	2.37	-20	158,0	6.22	114,0	4.49	25,7	1.01	20,8	0.82
—	—	—	1B24FLF24	2.37	-24	161,5	6.36	115,3	4.54	30,2	1.19	20,8	0.82
—	—	—	1B32FLF32	2.81	-32	187,2	7.37	124,0	4.88	41,4	1.62	31,8	1.25
—	—	—	1B40FLF32	3.31	-32	188,5	7.42	125,2	4.93	41,4	1.62	32,5	1.28

For flanges, split flange halves, kits and o-rings, see pages 190-195.

SAE Code 61 Split Flange 60° Elbow (FLG)

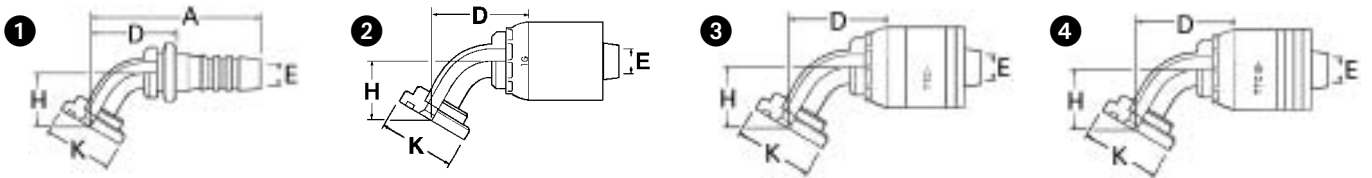

1 Nipple Part #	2 OTC Part #	3 TTC Part #	4 TTC12 Part #	Flange Head Ø	Hose Size	A		D		EØ		H	
						mm	in	mm	in	mm	in	mm	in
—	—	—	1B8FLG8	1.19	-08	90,7	3.57	61,0	2.40	9,4	0.37	28,7	1.13
—	—	—	1B12FLG12	1.50	-12	112,3	4.42	82,0	3.23	14,2	0.56	35,3	1.39
—	—	—	1B16FLG12	1.75	-12	128,3	5.05	98,0	3.86	14,2	0.56	38,4	1.51
1S16FLG16	1G16FLG16	1A16FLG16	1B16FLG16	1.75	-16	133,1	5.24	98,8	3.89	19,3	0.76	38,4	1.51
1S20FLG16	—	—	1B20FLG16	2.00	-16	151,1	5.95	116,8	4.60	19,3	0.76	39,9	1.57
—	—	—	1B20FLG20	2.00	-20	162,6	6.40	118,6	4.67	25,7	1.01	39,9	1.57
—	—	—	1B24FLG20	2.37	-20	186,4	7.34	142,5	5.61	25,7	1.01	46,0	1.81
1S24FLG24	1G24FLG24	1A24FLG24	1B24FLG24	2.37	-24	189,7	7.47	143,5	5.65	30,2	1.19	46,0	1.81
—	—	—	1B32FLG32	2.81	-32	195,1	7.68	132,1	5.20	41,4	1.62	72,9	2.87

For flanges, split flange halves, kits and o-rings, see pages 190-195.

SPECIALTY & TRUCK HOSE
 LOW & MEDIUM PRESSURE HOSE
 HIGH PRESSURE HOSE
 HOSE FITTINGS
 ADAPTERS & TUBE FITTINGS
 ACCESSORIES & ASSEMBLY INSTRUCTIONS
 HOSE ASSEMBLY EQUIPMENT
 APPENDICES

SAE Code 62 Split Flange (FH)

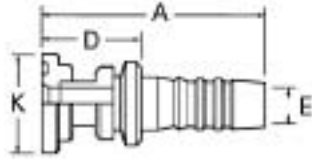

1

Global Nipples for use with Hose:

Clamp: 2661 (-12 thru -20), FC619 (-12 thru -20). **Socket 1SA:** 2681, FC194, FC211, FC310, FC510, FC639/FC839B (-4 thru -8), GH194 (-4 thru -20), GH663, GH681. **Socket 1SB:** 2781, FC195, FC212, FC466, FC498, FC598, FC579, FC639/FC839B (-10 thru -16), FC735 (-4 thru -20), FC849/FC849B (-06 thru -12), GH120 (-4 thru -20), GH195, GH781 (-04 thru -20), GH793, 2766.

2

3

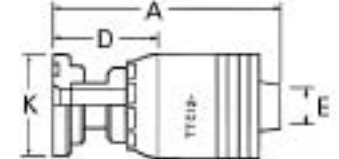

4

Global TTC12 Fittings for use with Hose: FC136, FC636, FC659, FC736, GH493.

1 Nipple Part #	2 OTC Part #	3 TTC Part #	4 TTC12 Part #	Flange Head Ø	Hose Size	A		D		EØ	
						mm	in	mm	in	mm	in
—	—	—	1B8FH8	1.25	-08	82,0	3.23	52,3	2.06	9,4	0.37
—	—	—	1B12FH8	1.63	-08	83,1	3.27	53,3	2.10	9,7	0.38
—	—	—	1B12FH10	1.63	-10	82,8	3.26	53,6	2.11	12,7	0.50
—	—	—	1B12FH12	1.63	-12	84,1	3.31	53,8	2.12	15,5	0.61
—	—	—	1B16FH12	1.87	-12	84,1	3.31	53,8	2.12	15,5	0.61
—	—	—	1B16FH16	1.87	-16	89,0	3.50	54,4	2.14	20,6	0.81
—	—	—	1B20FH16	2.13	-16	96,5	3.80	62,0	2.44	20,6	0.81
1S20FH20	—	—	1B20FH20	2.13	-20	107,7	4.24	63,8	2.51	26,7	1.05
—	—	—	1B24FH20	2.50	-20	107,7	4.24	63,8	2.51	26,7	1.05
—	—	—	1B24FH24	2.50	-24	111,8	4.40	65,5	2.58	32,0	1.26
—	—	—	1B32FH32	3.12	-32	129,8	5.11	66,8	2.63	41,4	1.62

For flanges, split flange halves, kits and o-rings, see pages 190-195.

SAE Code 62 Split Flange 22½° Elbow (FHD)

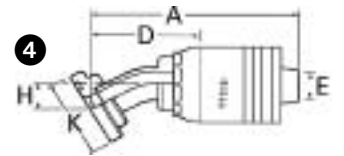

1 Nipple Part #	2 OTC Part #	3 TTC Part #	4 TTC12 Part #	Flange Head Ø	Hose Size	A		D		EØ		H
						mm	in	mm	in	mm	in	mm
—	—	—	1B32FHD32	3.12	-32	169,9	6.69	117,9	4.64	41,4	1.62	22,4 0.88

For flanges, split flange halves, kits and o-rings, see pages 190-195.

SAE Code 62 Split Flange 30° Elbow (FHF)

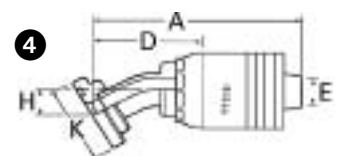

1 Nipple Part #	2 OTC Part #	3 TTC Part #	4 TTC12 Part #	Flange Head Ø	Hose Size	A		D		EØ		H
						mm	in	mm	in	mm	in	mm
—	—	—	1B32FHF32	3.12	-32	176,0	6.93	124,0	4.88	41,4	1.62	31,8 1.25

For flanges, split flange halves, kits and o-rings, see pages 190-195.

SPECIALTY &
TRUCK HOSE

LOW & MEDIUM
PRESSURE HOSE

HIGH PRESSURE HOSE

HOSE FITTINGS

ADAPTERS &
TUBE FITTINGS

ACCESSORIES &
ASSEMBLY INSTRUCTIONS

HOSE ASSEMBLY
EQUIPMENT

APPENDICES

SAE Code 62 Split Flange 45° Elbow (FHA)

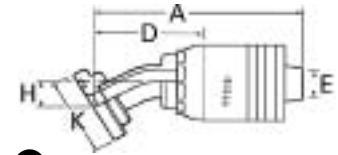

4 Global TTC12 Fittings for use with Hose: FC136, FC636, FC659, FC736, GH493.

1 Nipple Part #	2 OTC Part #	3 TTC Part #	4 TTC12 Part #	Flange Head Ø	Hose Size	A		D		EØ		H	
						mm	in	mm	in	mm	in	mm	in
—	—	—	1B12FHA12	1.63	-12	93,0	3.66	62,5	2.46	14,2	0.56	25,4	1.00
—	—	—	1B16FHA16	1.87	-16	110,5	4.35	76,2	3.00	19,3	0.76	26,9	1.06
—	—	—	1B20FHA16	2.13	-16	122,2	4.81	87,9	3.46	19,3	0.76	29,2	1.15
—	—	—	1B20FHA20	2.13	-20	133,6	5.26	89,4	3.52	25,7	1.01	29,2	1.15
—	—	—	1B24FHA24	2.50	-24	154,2	6.07	108,0	4.25	30,2	1.19	35,8	1.41
—	—	—	1B32FHA32	3.12	-32	191,3	7.53	128,3	5.05	41,4	1.62	50,8	2.00

For flanges, split flange halves, kits and o-rings, see pages 190-195.

SAE Code 62 Split Flange 60° Elbow (FHG)

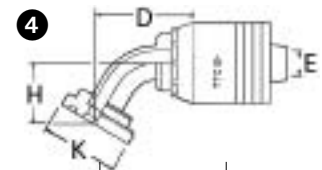

1 Nipple Part #	2 OTC Part #	3 TTC Part #	4 TTC12 Part #	Flange Head Ø	Hose Size	A		D		EØ		H	
						mm	in	mm	in	mm	in	mm	in
—	—	—	1B16FHG16	1.87	-16	132,3	5.21	98,6	3.88	20,6	0.81	38,4	1.51
—	—	—	1B20FHG16	2.13	-16	150,6	5.93	116,8	4.60	20,6	0.81	39,9	1.57
—	—	—	1B32FHG32	3.12	-32	184,2	7.25	132,1	5.20	41,4	1.62	72,9	2.87

For flanges, split flange halves, kits and o-rings, see pages 190-194.

SAE Code 62 Split Flange 67½° Elbow (FHE)

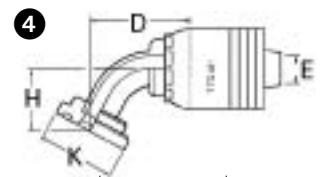

1 Nipple Part #	2 OTC Part #	3 TTC Part #	4 TTC12 Part #	Flange Head Ø	Hose Size	A		D		EØ		H	
						mm	in	mm	in	mm	in	mm	in
—	—	—	1B32FHE32	3.12	-32	181,1	7.13	129,0	5.08	41,4	1.62	82,6	3.25

For flanges, split flange halves, kits and o-rings, see pages 190-194.

SAE Code 62 Split Flange 90° Elbow (FHB)

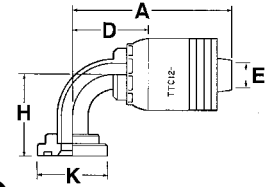

SPECIALTY &
TRUCK HOSE

LOW & MEDIUM
PRESSURE HOSE

HIGH PRESSURE HOSE

HOSE FITTINGS

ADAPTERS &
TUBE FITTINGS

ACCESSORIES &
ASSEMBLY INSTRUCTIONS

HOSE ASSEMBLY
EQUIPMENT

APPENDICES

1
Global Nipples for use with Hose:
Clamp: 2661 (-12 thru -20), FC619 (-12 thru -20). **Socket 1SA:** 2681, FC194, FC211, FC310, FC510, FC639/FC839B (-4 thru -8), GH194 (-4 thru -20), GH663, GH681. **Socket 1SB:** 2781, FC195, FC212, FC466, FC498, FC598, FC579, FC639/FC839B (-10 thru -16), FC735 (-4 thru -20), FC849/FC849B (-06 thru -12), GH120 (-4 thru -20), GH195, GH781 (-04 thru -20), GH793, 2766.

2
Global OTC Fittings for use with Hose: 2583, 2661, FC466, FC498, FC598, FC619, FC699

3
Global TTC Fittings for use with Hose: 2661(-12 thru -32), FC211, FC212, FC310, FC510, FC579, FC611, FC619 (-12 thru -32), FC639/FC839B, FC693, FC735, FC849/FC849B, GH120, GH194, GH195, GH663, GH681-6, GH781, GH793.

4
Global TTC12 Fittings for use with Hose: FC136, FC636, FC659, FC736, GH493.

1 Nipple Part #	2 OTC Part #	3 TTC Part #	4 TTC12 Part #	Flange Head Ø	Hose Size	A		D		EØ		H	
						mm	in	mm	in	mm	in	mm	in
—	—	—	1B8FHB8	1.25	-08	72,9	2.87	43,2	1.70	9,4	0.37	41,4	1.63
—	—	—	1B12FHB12	1.63	-12	88,6	3.49	58,4	2.30	14,2	0.56	54,1	2.13
—	—	—	1B16FHB12	1.87	-12	102,4	4.03	72,1	2.84	14,2	0.56	60,5	2.38
—	—	—	1B16FHB16	1.87	-16	107,2	4.22	72,6	2.86	19,3	0.76	60,5	2.38
—	—	—	1B20FHB16	2.13	-16	123,2	4.85	89,0	3.50	19,3	0.76	66,5	2.62
—	—	—	1B20FHB20	2.13	-20	134,6	5.30	90,7	3.57	25,7	1.01	66,5	2.62
—	—	—	1B24FHB24	2.50	-24	159,5	6.28	110,5	4.35	30,2	1.19	79,2	3.12
—	—	—	1B32FHB32	3.12	-32	182,9	7.20	119,9	4.72	41,4	1.62	114,3	4.50

For flanges, split flange halves, kits and o-rings, see pages 190-195.

JIS/BSPP Female Swivel (BF)***

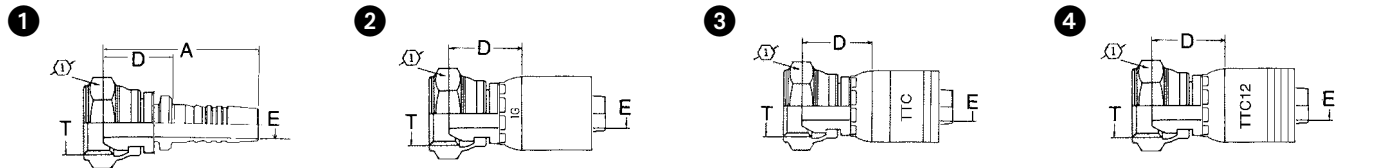

1 Nipple Part #	2 OTC Part #	3 TTC Part #	4 TTC12 Part #	Thd. T	Hose Size	A		D		EØ		⌀T	
						mm	in	mm	in	mm	in		mm
1S4BF4	1G4BF4	1A4BF4	—	G 1/4	-04	42,3	1.66	18,9	0.74	4,2	0.16	19,0	0.75
1S6BF6	1G6BF6	1A6BF6	1B6BF6	G 3/8	-06	46,4	1.83	21,1	0.83	6,7	0.26	22,0	0.87
1S8BF6	1G8BF6	1A8BF6	—	G 1/2	-06	47,9	1.88	22,6	0.89	6,7	0.26	27,0	1.06
1S8BF8	1G8BF8	1A8BF8	1B8BF8	G 1/2	-08	53,5	2.11	23,8	0.94	9,6	0.38	27,0	1.06
1S10BF10	1G10BF10	1A10BF10	—	G 5/8	-10	54,1	2.13	24,7	0.97	12,8	0.50	30,0	1.18
1S12BF12	1G12BF12	1A12BF12	1B12BF12	G 3/4	-12	55,5	2.18	25,3	1.00	15,5	0.61	32,0	1.26
1S16BF16	1G16BF16	1A16BF16	1B16BF16	G 1	-16	62,0	2.44	27,6	1.09	20,7	0.81	41,0	1.61
1S20BF20	1G20BF20	1AT20BF20**	1B20BF20	G 1 1/4	-20	73,6	2.90	29,6	1.16	26,6	1.05	50,0	1.97
1S24BF24	1G24BF24	—	1B24BF24	G 1 1/2	-24	80,0	3.15	33,7	1.33	32,0	1.26	55,0	2.16
1S32BF32	1G32BF32	—	—	G 2	-32	85,4	3.36	35,2	1.38	44,4	1.75	70,0	2.75

* Uses 1-wire braid hose socket.

**Uses 2-wire braid hose socket.

***The JIS parallel thread and the BSPP connection are interchangeable.

JIS/BSPP Female Swivel (JM)***

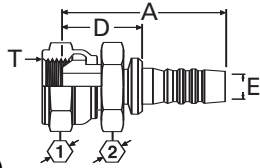

1 **Global Nipples for use with Hose:**
Clamp: 2661 (-12 thru -20), FC619 (-12 thru -20). **Socket 1SA:** 2681, FC194, FC211, FC310, FC510, FC639/FC839B (-4 thru -8), GH194 (-4 thru -20), GH663, GH681. **Socket 1SB:** 2781, FC195, FC212, FC466, FC498, FC598, FC579, FC639/FC839B (-10 thru -16), FC735 (-4 thru -20), FC849/FC849B (-06 thru -12), GH120 (-4 thru -20), GH195, GH781 (-04 thru -20), GH793, 2766.

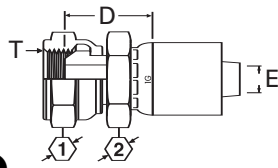

2 **Global OTC Fittings for use with Hose:** 2583, 2661, FC466, FC498, FC598, FC619, FC699

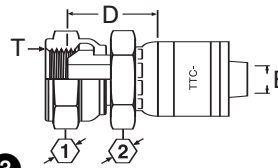

3 **Global TTC Fittings for use with Hose:** 2661(-12 thru -32), FC211, FC212, FC310, FC510, FC579, FC611, FC619 (-12 thru -32), FC639/FC839B, FC693, FC735, FC849/FC849B, GH120, GH194, GH195, GH663, GH681-6, GH781, GH793.

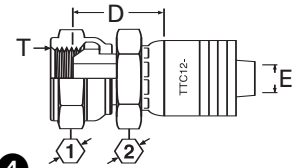

4 **Global TTC12 Fittings for use with Hose:** FC136, FC636, FC659, FC736, GH493.

1 Nipple Part #	2 OTC Part #	3 TTC Part #	4 TTC12 Part #	Thd. T	Hose Size	A		D		EØ		1		2	
						mm	in	mm	in	mm	in	mm	in	mm	in
1S4JM4	1G4JM4	1A4JM4	—	G 1/4	-04	47,0	1.85	23,6	0.93	4,2	0.16	19,0	0.75	19,0	0.75
1S6JM6	1G6JM6	1A6JM6	—	G 3/8	-06	51,0	2.01	25,7	1.01	6,7	0.26	22,0	0.87	22,0	0.87
1S8JM8	1G8JM8	1A8JM8	1B8JM8	G 1/2	-08	58,0	2.28	28,3	1.11	9,6	0.38	27,0	1.06	27,0	1.06
1S12JM12	1G12JM12	1A12JM12	1B12JM12	G 3/4	-12	62,0	2.44	31,8	1.25	15,5	0.61	32,0	1.26	36,0	1.42
1S16JM16	1G16JM16	1A16JM16	1B16JM16	G 1	-16	69,0	2.72	34,6	1.36	20,7	0.81	41,0	1.61	41,0	1.61
1S20JM20	1G20JM20	1AP20JM20*	1B20JM20	G 1 1/4	-20	80,2	3.16	36,2	1.42	26,6	1.05	50,0	1.97	46,0	1.81
—	—	1AT20JM20**	—	G 1 1/4	-20	80,2	3.16	36,2	1.42	26,6	1.05	50,0	1.97	46,0	1.81

JIS/BSPP Female Swivel, 45° Elbow (BFA)***

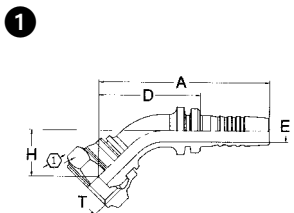

1 **Global Nipples for use with Hose:**
Clamp: 2661 (-12 thru -20), FC619 (-12 thru -20). **Socket 1SA:** 2681, FC194, FC211, FC310, FC510, FC639/FC839B (-4 thru -8), GH194 (-4 thru -20), GH663, GH681. **Socket 1SB:** 2781, FC195, FC212, FC466, FC498, FC598, FC579, FC639/FC839B (-10 thru -16), FC735 (-4 thru -20), FC849/FC849B (-06 thru -12), GH120 (-4 thru -20), GH195, GH781 (-04 thru -20), GH793, 2766.

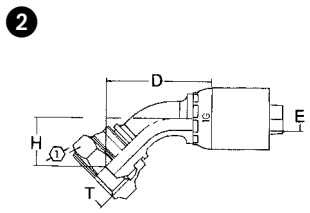

2 **Global OTC Fittings for use with Hose:** 2583, 2661, FC466, FC498, FC598, FC619, FC699

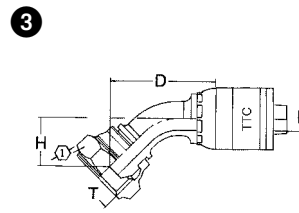

3 **Global TTC Fittings for use with Hose:** 2661(-12 thru -32), FC211, FC212, FC310, FC510, FC579, FC611, FC619 (-12 thru -32), FC639/FC839B, FC693, FC735, FC849/FC849B, GH120, GH194, GH195, GH663, GH681-6, GH781, GH793.

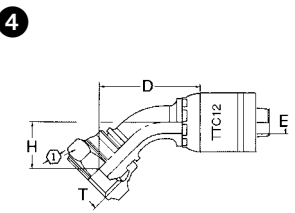

4 **Global TTC12 Fittings for use with Hose:** FC136, FC636, FC659, FC736, GH493.

1 Nipple Part #	2 OTC Part #	3 TTC Part #	4 TTC12 Part #	Thd. T	Hose Size	A		D		EØ		H		1		2	
						mm	in	mm	in	mm	in	mm	in	mm	in	mm	in
1S4BFA4	1G4BFA4	1A4BFA4	—	G 1/4	-04	65,3	2.57	41,9	1.65	4,2	0.16	16,5	0.65	19,0	0.75	19,0	0.75
1S6BFA6	1G6BFA6	1A6BFA6	—	G 3/8	-06	73,8	2.90	48,5	1.91	6,7	0.26	19,0	0.75	22,0	0.87	22,0	0.87
1S8BFA8	1G8BFA8	1A8BFA8	1B8BFA8	G 1/2	-08	91,5	3.60	61,8	2.43	9,6	0.38	24,8	0.98	27,0	1.06	27,0	1.06
1S10BFA10	1G10BFA10	1A10BFA10	—	G 5/8	-10	100,4	3.95	71,0	2.79	12,8	0.50	27,4	1.08	30,0	1.18	30,0	1.18
1S12BFA12	1G12BFA12	1A12BFA12	1B12BFA12	G 3/4	-12	108,8	4.28	78,6	3.09	15,5	0.61	29,4	1.16	32,0	1.26	32,0	1.26
1S16BFA16	1G16BFA16	1A16BFA16	1B16BFA16	G 1	-16	126,8	4.99	92,4	3.09	20,7	0.81	33,2	1.31	41,0	1.61	41,0	1.61
1S20BFA20	1G20BFA20	1AT20BFA20**	1B20BFA20	G 1 1/4	-20	153,6	6.05	109,6	4.31	26,6	1.05	37,2	1.46	50,0	1.97	46,0	1.81

* Uses 1-wire braid hose socket.
 **Uses 2-wire braid hose socket.
 ***The JIS parallel thread and the BSPP connection are interchangeable.

JIS/BSPP Female Swivel 90° Elbow (BFB)***

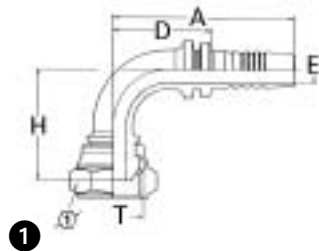

1
Global Nipples for use with Hose:
Clamp: 2661 (-12 thru -20), FC619 (-12 thru -20). **Socket 1SA:** 2681, FC194, FC211, FC310, FC510, FC639/FC839B (-4 thru -8), GH194 (-4 thru -20), GH663, GH681. **Socket 1SB:** 2781, FC195, FC212, FC466, FC498, FC598, FC579, FC639/FC839B (-10 thru -16), FC735 (-4 thru -20), FC849/FC849B (-06 thru -12), GH120 (-4 thru -20), GH195, GH781 (-04 thru -20), GH793, 2766.

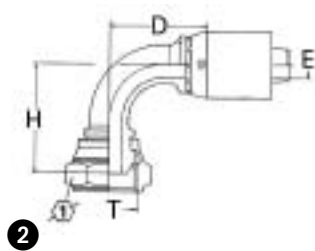

2
Global OTC Fittings for use with Hose: 2583, 2661, FC466, FC498, FC598, FC619, FC699

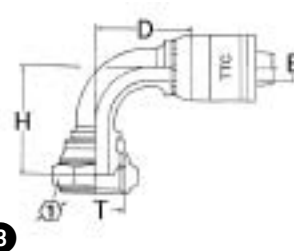

3
Global TTC Fittings for use with Hose: 2661(-12 thru -32), FC211, FC212, FC310, FC510, FC579, FC611, FC619 (-12 thru -32), FC639/FC839B, FC693, FC735, FC849/FC849B, GH120, GH194, GH195, GH663, GH681-6, GH781, GH793.

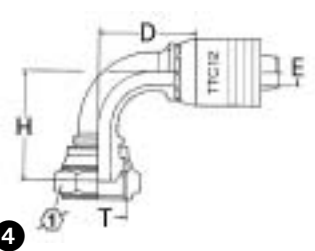

4
Global TTC12 Fittings for use with Hose: FC136, FC636, FC659, FC736, GH493.

1 Nipple Part #	2 OTC Part #	3 TTC Part #	4 TTC12 Part #	Thd. T	Hose Size	A		D		EØ		H		1
						mm	in	mm	in	mm	in	mm	in	
1S4BFB4	1G4BFB4	1A4BFB4	—	G 1/4	-04	45,8	1.80	22,4	0.88	4,2	0.16	24,8	0.98	17,0 0.67
1S6BFB6	1G6BFB6	1A6BFB6	—	G 3/8	-06	58,9	2.32	33,6	1.32	6,7	0.26	35,0	1.38	22,0 0.87
1S8BFB6	1G8BFB6	1A8BFB6	—	G 1/2	-06	75,7	2.98	50,4	1.98	6,7	0.26	47,8	1.88	27,0 1.06
1S8BFB8	1G8BFB8	1A8BFB8	1B8BFB8	G 1/2	-08	65,5	2.58	35,8	1.41	9,6	0.38	37,5	1.48	27,0 1.06
1S10BFB10	1G10BFB10	1A10BFB10	—	G 5/8	-10	90,6	3.57	61,2	1.41	12,8	0.50	56,3	2.22	27,0 1.06
1S12BFB12	1G12BFB12	1A12BFB12	1B12BFB12	G 3/4	-12	82,2	3.24	52,0	2.05	15,5	0.61	47,5	1.87	32,0 1.26
1S16BFB16	1G16BFB16	1A16BFB16	1B16BFB16	G 1	-16	118,2	4.65	83,8	3.30	20,7	0.81	71,5	2.81	41,0 1.61
1S20BFB20	1G20BFB20	1AT20BFB20**	1B20BFB20	G 1/4	-20	146,2	5.75	102,2	4.02	26,6	1.05	82,5	3.25	50,0 1.97

BSP Male Tapered, BSPT (BT)

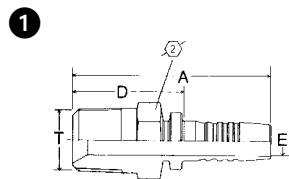

1
Global Nipples for use with Hose:
Clamp: 2661 (-12 thru -20), FC619 (-12 thru -20). **Socket 1SA:** 2681, FC194, FC211, FC310, FC510, FC639/FC839B (-4 thru -8), GH194 (-4 thru -20), GH663, GH681. **Socket 1SB:** 2781, FC195, FC212, FC466, FC498, FC598, FC579, FC639/FC839B (-10 thru -16), FC735 (-4 thru -20), FC849/FC849B (-06 thru -12), GH120 (-4 thru -20), GH195, GH781 (-04 thru -20), GH793, 2766.

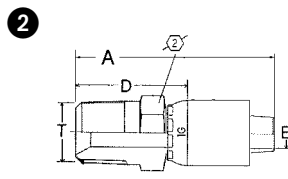

2
Global OTC Fittings for use with Hose: 2583, 2661, FC466, FC498, FC598, FC619, FC699

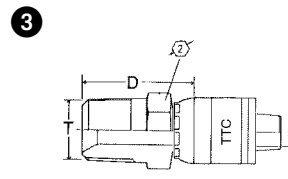

3
Global TTC Fittings for use with Hose: 2661(-12 thru -32), FC211, FC212, FC310, FC510, FC579, FC611, FC619 (-12 thru -32), FC639/FC839B, FC693, FC735, FC849/FC849B, GH120, GH194, GH195, GH663, GH681-6, GH781, GH793.

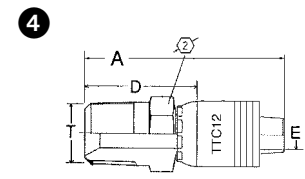

4
Global TTC12 Fittings for use with Hose: FC136, FC636, FC659, FC736, GH493.

1 Nipple Part #	2 OTC Part #	3 TTC Part #	4 TTC12 Part #	Thd. T	Hose Size	A		D		EØ		2
						mm	in	mm	in	mm	in	
1S4BT4	1G4BT4	1A4BT4	—	R 1/4 -19	-04	50,6	1.99	27,2	1.07	4,2	0.16	14,0 0.55
1S6BT6	1G6BT6	1A6BT6	1B6BT6	R 3/8 -19	-06	54,9	2.16	29,6	1.16	6,7	0.26	19,0 0.75
1S8BT8	1G8BT8	1A8BT8	1B8BT8	R 1/2 -14	-08	66,2	2.61	36,5	1.44	9,6	0.38	22,0 0.87
1S12BT12	1G12BT12	1A12BT12	1B12BT12	R 3/4 -14	-12	71,1	2.80	40,9	1.61	15,5	0.61	30,0 1.18
1S16BT16	1G16BT16	1A16BT16	1B16BT16	R 1 -11	-16	81,2	3.20	46,8	1.84	20,7	0.81	36,0 1.42
1S20BT20	1G20BT20	1AT20BT20**	1B20BT20	R 1 1/4 -11	-20	96,2	3.79	52,2	2.05	26,6	1.05	46,0 1.81
—	—	—	1B24BT24	R 1 1/4 -11	-24	100,8	3.97	54,5	2.14	32,0	1.26	50,0 1.97

* Uses 1-wire braid hose socket.
**Uses 2-wire braid hose socket.
***The JIS parallel thread and the BSPP connection are interchangeable.

SPECIALTY & TRUCK HOSE
LOW & MEDIUM PRESSURE HOSE
HIGH PRESSURE HOSE
HOSE FITTINGS
ADAPTERS & TUBE FITTINGS
ACCESSORIES & ASSEMBLY INSTRUCTIONS
HOSE ASSEMBLY EQUIPMENT
APPENDICES

BSP Male Parallel (BP)

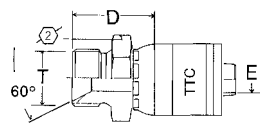
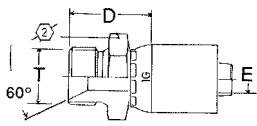
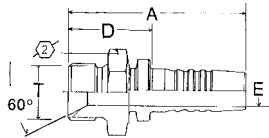

1
Global Nipples for use with Hose:
Clamp: 2661 (-12 thru -20), FC619 (-12 thru -20). **Socket 1SA:** 2681, FC194, FC211, FC310, FC510, FC639/FC839B (-4 thru -8), GH194 (-4 thru -20), GH663, GH681. **Socket 1SB:** 2781, FC195, FC212, FC466, FC498, FC598, FC579, FC639/FC839B (-10 thru -16), FC735 (-4 thru -20), FC849/FC849B (-06 thru -12), GH120 (-4 thru -20), GH195, GH781 (-04 thru -20), GH793, 2766.

2
Global OTC Fittings for use with Hose: 2583, 2661, FC466, FC498, FC598, FC619, FC699

3
Global TTC Fittings for use with Hose: 2661(-12 thru -32), FC211, FC212, FC310, FC510, FC579, FC611, FC619 (-12 thru -32), FC639/FC839B, FC693, FC735, FC849/FC849B, GH120, GH194, GH195, GH663, GH681-6, GH781, GH793.

4
Global TTC12 Fittings for use with Hose: FC136, FC636, FC659, FC736, GH493.

1 Nipple Part #	2 OTC Part #	3 TTC Part #	4 TTC12 Part #	Thd. T	Hose Size	A		D		EØ		⊠	
						mm	in	mm	in	mm	in		mm
1S4BP4	1G4BP4	1A4BP4	—	G 1/4	-04	44,3	1.74	20,9	0.82	4,2	0.16	19,0	0.75
1S6BP6	1G6BP6	1A6BP6	—	G 3/8	-06	48,4	1.90	23,1	0.91	6,7	0.26	22,0	0.87
1S8BP6	1G8BP6	1A8BP6	—	G 1/2	-06	52,4	2.06	27,1	1.07	6,7	0.26	27,0	1.06
1S8BP8	1G8BP8	1A8BP8	—	G 1/2	-08	58,0	2.28	28,3	1.11	9,6	0.38	27,0	1.06
1S12BP12	1G12BP12	1A12BP12	—	G 3/4	-12	63,1	2.48	32,9	1.29	15,5	0.61	32,0	1.26
1S16BP16	1G16BP16	1A16BP16	—	G 1	-16	70,9	2.79	36,5	1.44	20,7	0.81	41,0	1.61

DKO Female Swivel, Light Duty (DL)

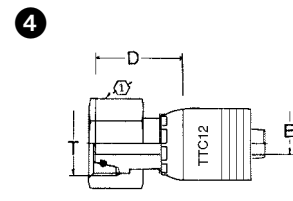
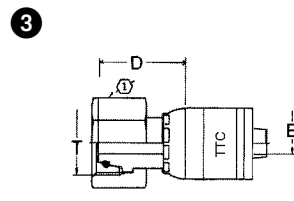
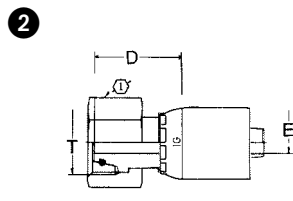
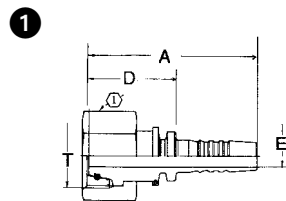

1 Nipple Part #	2 OTC Part #	3 TTC Part #	4 TTC12 Part #	Thd. T	Tube O.D.	Hose Size	A		D		EØ		⊠	
							mm	in	mm	in	mm	in		mm
1S5DL4	1G5DL4	1A5DL4	—	M12 x 1.5	6	-04	48,0	1.89	24,6	0.97	4,2	0.16	17,0	0.67
S6DL4	1G6DL4	1A6DL4	—	M14 x 1.5	8	-04	46,0	1.81	22,6	0.89	4,2	0.16	17,0	0.67
1S8DL6	1G8DL6	1A8DL6	1B8DL6	M16 x 1.5	10	-06	56,9	2.24	31,6	1.24	6,7	0.26	19,0	0.75
1S10DL6	1G10DL6	1A10DL6	1B10DL6	M18 x 1.5	12	-06	51,2	2.01	25,9	1.02	6,7	0.26	22,0	0.87
1S12DL8	1G12DL8	1A12DL8	1B12DL8	M22 x 1.5	15	-08	58,3	2.29	28,6	1.12	9,6	0.38	27,0	1.06
1S16DL10	1G16DL10	1A16DL10	1B16DL10	M26 x 1.5	18	-10	59,2	2.33	29,8	1.17	12,8	0.50	32,0	1.26
1S20DL12	1G20DL12	1A20DL12	1B20DL12	M30 x 2	22	-12	62,5	2.46	32,3	1.27	15,5	0.61	36,0	1.42
1S25DL16	1G25DL16	1A25DL16	1B25DL16	M36 x 2	28	-16	68,2	2.68	33,8	1.33	20,7	0.81	41,0	1.61
1S32DL20	1G32DL20	1AT32DL20**	1B32DL20	M45 x 2	35	-20	83,7	3.29	39,7	1.56	26,6	1.05	50,0	1.97
1S40DL24	1G40DL24	1A40DL24	—	M52 x 2	42	-24	87,2	3.43	40,9	1.61	32,0	1.26	60,0	2.36

**Uses 2-wire braid hose socket.

DKO Female Swivel, Light Duty, 45° Elbow (DLA)

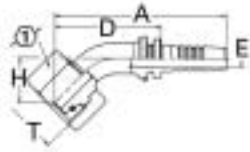

1
Global Nipples for use with Hose:
Clamp: 2661 (-12 thru -20), FC619 (-12 thru -20). **Socket 1SA:** 2681, FC194, FC211, FC310, FC510, FC639/FC839B (-4 thru -8), GH194 (-4 thru -20), GH663, GH681. **Socket 1SB:** 2781, FC195, FC212, FC466, FC498, FC598, FC579, FC639/FC839B (-10 thru -16), FC735 (-4 thru -20), FC849/FC849B (-06 thru -12), GH120 (-4 thru -20), GH195, GH781 (-04 thru -20), GH793, 2766.

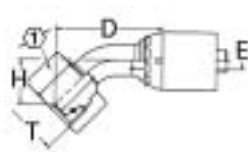

2
Global OTC Fittings for use with Hose: 2583, 2661, FC466, FC498, FC598, FC619, FC699

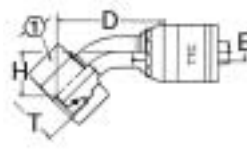

3
Global TTC Fittings for use with Hose: 2661(-12 thru -32), FC211, FC212, FC310, FC510, FC579, FC611, FC619 (-12 thru -32), FC639/FC839B, FC693, FC735, FC849/FC849B, GH120, GH194, GH195, GH663, GH681-6, GH781, GH793.



4
Global TTC12 Fittings for use with Hose: FC136, FC636, FC659, FC736, GH493.

1 Nipple Part #	2 OTC Part #	3 TTC Part #	4 TTC12 Part #	Thd. T	Tube O.D.	Hose Size	A		D		EØ		H		1	
							mm	in	mm	in	mm	in	mm	in		mm
1S6DLA4	1G6DLA4	1A6DLA4	—	M14 x 1.5	8	-04	62,4	2.46	39,0	1.53	4,2	0.16	17,5	0.69	17,0	0.67
1S8DLA6	1G8DLA6	1A8DLA6	—	M16 x 1.5	10	-06	66,8	2.63	41,5	1.63	6,7	0.26	19,0	0.75	19,0	0.75
1S10DLA6	1G10DLA6	1A10DLA6	—	M18 x 1.5	12	-06	69,8	2.75	44,5	1.75	6,7	0.26	20,5	0.81	22,0	0.87
1S12DLA8	1G12DLA8	1A12DLA8	—	M22 x 1.5	15	-08	81,7	3.22	52,0	2.05	9,6	0.38	21,5	0.85	27,0	1.06
1S16DLA10	1G16DLA10	1A16DLA10	—	M26 x 1.5	18	-10	88,4	3.48	59,0	2.32	12,8	0.50	27,5	1.08	32,0	1.26
1S20DLA12	1G20DLA12	1A20DLA12	—	M30 x 2	22	-12	98,4	3.87	68,2	2.68	15,5	0.61	26,0	1.02	36,0	1.42
1S25DLA16	1G25DLA16	1A25DLA16	—	M36 x 2	28	-16	120,0	4.72	85,6	3.37	20,7	0.81	33,5	1.32	41,0	1.61
—	—	1AT32DLA20**	—	M45 x 2	35	-20	148,0	5.83	104,0	4.09	26,6	1.05	43,0	1.69	50,0	1.97

DKO Female Swivel, Light Duty, 90° Elbow (DLB)

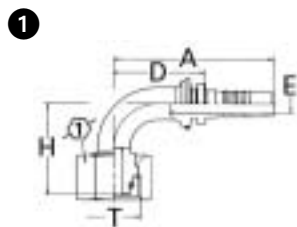

1
Global Nipples for use with Hose:
Clamp: 2661 (-12 thru -20), FC619 (-12 thru -20). **Socket 1SA:** 2681, FC194, FC211, FC310, FC510, FC639/FC839B (-4 thru -8), GH194 (-4 thru -20), GH663, GH681. **Socket 1SB:** 2781, FC195, FC212, FC466, FC498, FC598, FC579, FC639/FC839B (-10 thru -16), FC735 (-4 thru -20), FC849/FC849B (-06 thru -12), GH120 (-4 thru -20), GH195, GH781 (-04 thru -20), GH793, 2766.

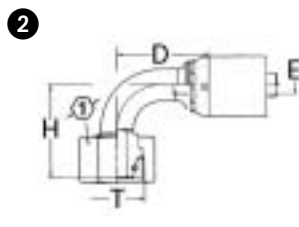

2
Global OTC Fittings for use with Hose: 2583, 2661, FC466, FC498, FC598, FC619, FC699

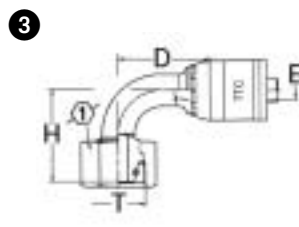

3
Global TTC Fittings for use with Hose: 2661(-12 thru -32), FC211, FC212, FC310, FC510, FC579, FC611, FC619 (-12 thru -32), FC639/FC839B, FC693, FC735, FC849/FC849B, GH120, GH194, GH195, GH663, GH681-6, GH781, GH793.

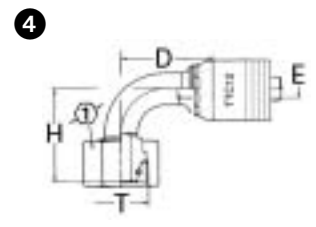

4
Global TTC12 Fittings for use with Hose: FC136, FC636, FC659, FC736, GH493.

1 Nipple Part #	2 OTC Part #	3 TTC Part #	4 TTC12 Part #	Thd. T	Tube O.D.	Hose Size	A		D		EØ		H		1	
							mm	in	mm	in	mm	in	mm	in		mm
1S5DLB4	1G5DLB4	1A5DLB4	—	M12 x 1.5	6	-04	49,9	1.96	26,5	1.04	4,2	0.16	26,5	1.04	17,0	0.67
1S5DLB4	1G6DLB4	1A6DLB4	—	M14 x 1.5	8	-04	51,9	2.04	28,5	1.12	4,2	0.16	31,5	1.24	17,0	0.67
1S8DLB6	1G8DLB6	1A8DLB6	1B8DLB6	M16 x 1.5	10	-06	57,3	2.25	32,0	1.26	6,7	0.26	35,5	1.40	19,0	0.75
1S10DLB6	1G10DLB6	1A10DLB6	—	M18 x 1.5	12	-06	60,3	2.37	35,0	1.38	6,7	0.26	39,0	1.53	22,0	0.87
1S12DLB8	1G12DLB8	1A12DLB8	1B12DLB8	M22 x 1.5	15	-08	72,0	2.83	42,3	1.66	9,6	0.38	43,0	1.69	27,0	1.06
1S16DLB10	1G16DLB10	1A16DLB10	—	M26 x 1.5	18	-10	82,9	3.26	53,5	2.11	12,8	0.50	59,0	2.32	32,0	1.26
1S20DLB12	1G20DLB12	1A20DLB12	1B20DLB12	M30 x 2	22	-12	95,0	3.74	64,8	2.55	15,5	0.61	54,0	2.12	36,0	1.42
1S25DLB16	1G25DLB16	1A25DLB16	—	M36 x 2	28	-16	154,4	6.08	120,0	4.72	20,7	0.81	71,0	2.79	41,0	1.61
—	—	1AT32DLB20**	—	M45 x 2	35	-20	119,0	4.68	75,0	2.95	26,6	1.05	76,0	2.99	50,0	1.97

**Uses 2-wire braid hose socket.

24° Male, Light Duty (DK)

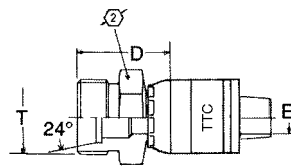
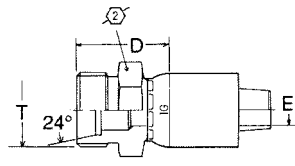
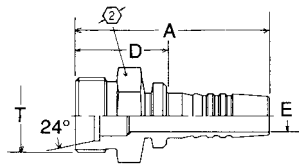

1
Global Nipples for use with Hose:
Clamp: 2661 (-12 thru -20), FC619 (-12 thru -20). **Socket 1SA:** 2681, FC194, FC211, FC310, FC510, FC639/FC839B (-4 thru -8), GH194 (-4 thru -20), GH663, GH681. **Socket 1SB:** 2781, FC195, FC212, FC466, FC498, FC598, FC579, FC639/FC839B (-10 thru -16), FC735 (-4 thru -20), FC849/FC849B (-06 thru -12), GH120 (-4 thru -20), GH195, GH781 (-04 thru -20), GH793, 2766.

2
Global OTC Fittings for use with Hose: 2583, 2661, FC466, FC498, FC598, FC619, FC699

3
Global TTC Fittings for use with Hose: 2661(-12 thru -32), FC211, FC212, FC310, FC510, FC579, FC611, FC619 (-12 thru -32), FC639/FC839B, FC693, FC735, FC849/FC849B, GH120, GH194, GH195, GH663, GH681-6, GH781, GH793.

4
Global TTC12 Fittings for use with Hose: FC136, FC636, FC659, FC736, GH493.

1 Nipple Part #	2 OTC Part #	3 TTC Part #	4 TTC12 Part #	Thd. T	Tube O.D.	Hose Size	A		D		EØ		②	
							mm	in	mm	in	mm	in		mm
1S5DK4	1G5DK4	1A5DK4	—	M12 x 1.5	6	-04	44,7	1.76	21,3	0.84	4,2	0.16	12,0	0.47
1S6DK4	1G6DK4	1A6DK4	—	M14 x 1.5	8	-04	44,5	1.75	21,1	0.83	4,2	0.16	14,0	0.55
1S8DK6	1G8DK6	1A8DK6	—	M16 x 1.5	10	-06	52,0	2.05	26,7	1.05	6,7	0.26	17,0	0.67
1S10DK6	1G10DK6	1A10DK6	—	M18 x 1.5	12	-06	49,0	1.93	23,7	0.93	6,7	0.26	19,0	0.75
1S12DK8	1G12DK8	1A12DK8	—	M22 x 1.5	15	-08	56,0	2.20	26,3	1.03	9,6	0.38	24,0	0.94
1S16DK10	1G16DK10	1A16DK10	—	M26 x 1.5	18	-10	56,0	2.20	26,6	1.05	12,8	0.50	27,0	1.06
1S20DK12	1G20DK12	1A20DK12	—	M30 x 2	22	-12	62,0	2.44	31,8	1.25	15,5	0.61	32,0	1.26
1S25DK16	1G25DK16	1A25DK16	—	M36 x 2	28	-16	66,0	2.60	31,6	1.24	20,7	0.81	41,0	1.61
1S32DK20	1G32DK20	1AT32DK20**	—	M45 x 2	35	-20	79,4	3.12	35,4	1.39	26,6	1.05	46,0	1.81

DKO Female Swivel, Heavy Duty (DS)

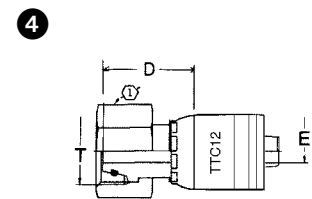
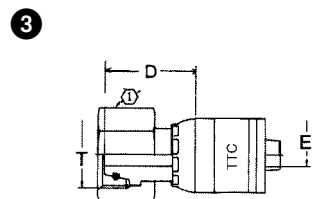
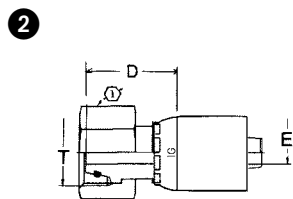
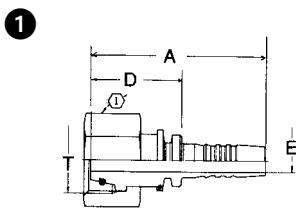

1 Nipple Part #	2 OTC Part #	3 TTC Part #	4 TTC12 Part #	Thd. T	Tube O.D.	Hose Size	A		D		EØ		①	
							mm	in	mm	in	mm	in		mm
1S5DS4	1G5DS4	1A5DS4	—	M16 x 1.5	8	-04	49,6	1.95	26,2	1.03	4,2	0.16	19,0	0.75
1S6DS4	1G6DS4	1A6DS4	—	M18 x 1.5	10	-04	50,8	2.00	27,4	1.08	4,2	0.16	22,0	0.87
1S8DS6	1G8DS6	1A8DS6	1B8DS6	M20 x 1.5	12	-06	53,8	2.12	28,5	1.12	6,7	0.26	24,0	0.94
1S10DS6	1G10DS6	1A10DS6	1B10DS6	M22 x 1.5	14	-06	56,9	2.24	31,6	1.24	6,7	0.26	27,0	1.06
1S12DS8	1G12DS8	1A12DS8	1B12DS8	M24 x 1.5	16	-08	62,4	2.46	32,7	1.29	9,6	0.38	30,0	1.18
1S16DS10	1G16DS10	1A16DS10	1B16DS10	M30 x 2	20	-10	66,9	2.63	37,5	1.48	12,8	0.50	36,0	1.42
1S20DS12	1G20DS12	1A20DS12	1B20DS12	M36 x 2	25	-12	72,0	2.83	41,8	1.64	15,5	0.61	46,0	1.81
1S25DS16	1G25DS16	1A25DS16	1B25DS16	M42 x 2	30	-16	78,5	3.09	44,1	1.44	20,7	0.81	50,0	1.97
—	—	—	1B32DS20	M52 x 2	38	-20	93,7	3.69	49,7	1.96	26,6	1.05	60,0	2.36

**Uses 2-wire braid hose socket.

DKO Female Swivel, Heavy Duty, 45° Elbow (DSA)

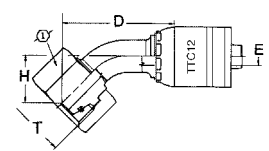
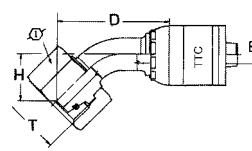
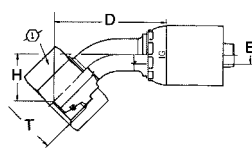
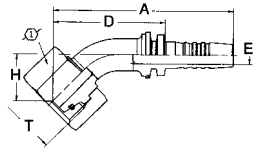

1 Global Nipples for use with Hose:
Clamp: 2661 (-12 thru -20), FC619 (-12 thru -20). **Socket 1SA:** 2681, FC194, FC211, FC310, FC510, FC639/FC839B (-4 thru -8), GH194 (-4 thru -20), GH663, GH681. **Socket 1SB:** 2781, FC195, FC212, FC466, FC498, FC598, FC579, FC639/FC839B (-10 thru -16), FC735 (-4 thru -20), FC849/FC849B (-06 thru -12), GH120 (-4 thru -20), GH195, GH781 (-04 thru -20), GH793, 2766.

2 Global OTC Fittings for use with Hose: 2583, 2661, FC466, FC498, FC598, FC619, FC699

3 Global TTC Fittings for use with Hose: 2661(-12 thru -32), FC211, FC212, FC310, FC510, FC579, FC611, FC619 (-12 thru -32), FC639/FC839B, FC693, FC735, FC849/FC849B, GH120, GH194, GH195, GH663, GH681-6, GH781, GH793.

4 Global TTC12 Fittings for use with Hose: FC136, FC636, FC659, FC736, GH493.

1 Nipple Part #	2 OTC Part #	3 TTC Part #	4 TTC12 Part #	Thd. T	Tube O.D.	Hose Size	A		D		EØ		H		I	
							mm	in	mm	in	mm	in	mm	in		mm
1S6DSA4	1G6DSA4	1A6DSA4	—	M18 x 1.5	10	-04	61,4	2.42	38,0	1.50	4,2	0.16	17,0	0.67	22,0	0.87
1S8DSA6	1G8DSA6	1A8DSA6	1B8DSA6	M20 x 1.5	12	-06	68,3	2.69	43,0	1.69	6,7	0.26	19,0	0.75	24,0	0.94
1S10DSA6	1G10DSA6	1A10DSA6	—	M22 x 1.5	14	-06	68,8	2.71	43,5	1.71	6,7	0.26	20,0	0.79	27,0	1.06
1S12DSA8	1G12DSA8	1A12DSA8	1B12DSA8	M24 x 1.5	16	-08	79,7	3.14	50,0	1.97	9,6	0.38	23,0	0.90	30,0	1.18
1S16DSA10	1G16DSA10	1A16DSA10	1B16DSA10	M30 x 2	20	-10	89,3	3.51	59,9	2.36	12,8	0.50	26,0	1.02	36,0	1.42
1S20DSA12	1G20DSA12	1A20DSA12	1B20DSA12	M36 x 2	25	-12	107,4	4.23	77,2	3.04	15,5	0.61	32,5	1.28	46,0	1.81
1S25DSA16	1G25DSA16	1A25DSA16	1B25DSA16	M42 x 2	30	-16	121,4	4.78	87,0	3.42	20,7	0.81	37,5	1.48	55,0	2.16

DKO Female Swivel, Heavy Duty, 90° Elbow (DSB)

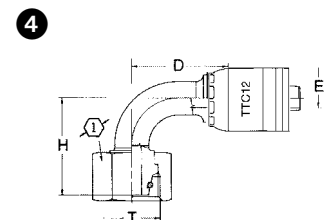
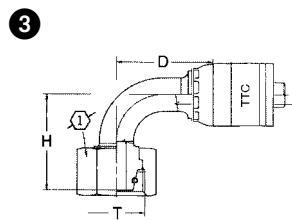
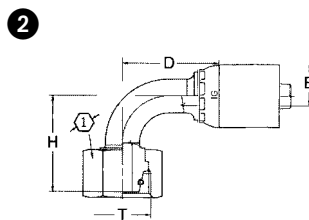
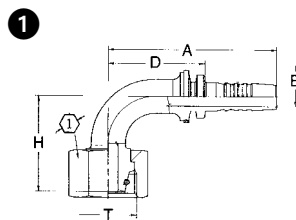

1 Nipple Part #	2 OTC Part #	3 TTC Part #	4 TTC12 Part #	Thd. T	Tube O.D.	Hose Size	A		D		EØ		H		I	
							mm	in	mm	in	mm	in	mm	in		
1S6DSB4	1G6DSB4	1A6DSB4	—	M18 x 1.5	10	-04	54,5	2.14	31,0	1.22	4,2	0.16	33,5	1.32	22,0	0.87
1S8DSB6	1G8DSB6	1A8DSB6	1B8DSB6	M20 x 1.5	12	-06	60,3	2.37	35,0	1.38	6,7	0.26	35,0	1.38	24,0	0.94
1S10DSB6	1G10DSB6	1A10DSB6	1B10DSB6	M22 x 1.5	14	-06	63,8	2.51	38,5	1.51	6,7	0.26	42,0	1.65	27,0	1.06
1S12DSB8	1G12DSB8	1A12DSB8	1B12DSB8	M24 x 1.5	16	-08	73,7	2.90	44,0	1.73	9,6	0.38	49,0	1.93	30,0	1.18
1S16DSB10	1G16DSB10	1A16DSB10	1B16DSB10	M30 x 2	20	-10	82,0	3.23	52,6	2.07	12,8	0.50	53,5	2.11	36,0	1.42
1S20DSB12	1G20DSB12	1A20DSB12	1B20DSB12	M36 x 2	25	-12	93,0	3.66	62,8	2.47	15,5	0.61	64,5	2.54	46,0	1.81
1S25DSB16	1G25DSB16	1A25DSB16	1B25DSB16	M42 x 2	30	-16	104,0	4.09	69,6	2.74	20,7	0.81	74,0	2.91	50,0	1.97

24° Male, Heavy Duty (EK)

SPECIALTY & TRUCK HOSE

LOW & MEDIUM PRESSURE HOSE

HIGH PRESSURE HOSE

HOSE FITTINGS

ADAPTERS & TUBE FITTINGS

ACCESSORIES & ASSEMBLY INSTRUCTIONS

HOSE ASSEMBLY EQUIPMENT

APPENDICES

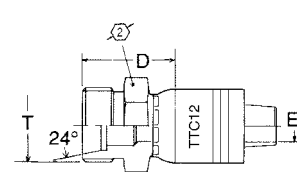
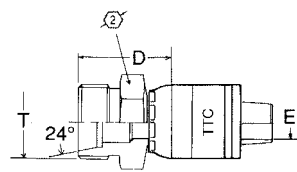
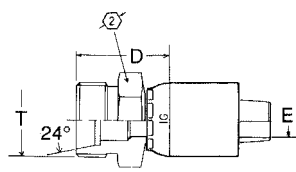
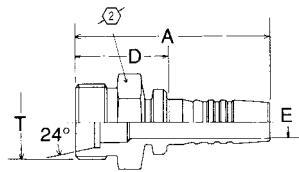

1 Global Nipples for use with Hose: **Clamp:** 2661 (-12 thru -20), FC619 (-12 thru -20). **Socket 1SA:** 2681, FC194, FC211, FC310, FC510, FC639/FC839B (-4 thru -8), GH194 (-4 thru -20), GH663, GH681. **Socket 1SB:** 2781, FC195, FC212, FC466, FC498, FC598, FC579, FC639/FC839B (-10 thru -16), FC735 (-4 thru -20), FC849/FC849B (-06 thru -12), GH120 (-4 thru -20), GH195, GH781 (-04 thru -20), GH793, 2766.

2 Global OTC Fittings for use with Hose: 2583, 2661, FC466, FC498, FC598, FC619, FC699

3 Global TTC Fittings for use with Hose: 2661(-12 thru -32), FC211, FC212, FC310, FC510, FC579, FC611, FC619 (-12 thru -32), FC639/FC839B, FC693, FC735, FC849/FC849B, GH120, GH194, GH195, GH663, GH681-6, GH781, GH793.

4 Global TTC12 Fittings for use with Hose: FC136, FC636, FC659, FC736, GH493.

1 Nipple Part #	2 OTC Part #	3 TTC Part #	4 TTC12 Part #	Thd. T	Tube O.D.	Hose Size	A		D		EØ		2	
							mm	in	mm	in	mm	in		mm
1S5DK4	1G5DK4	1A5DK4	—	M12 x 1.5	6	-04	44,7	1.76	21,3	0.84	4,2	0.16	12,0	0.47
1S5EK4	1G5EK4	1A5EK4	—	M16 x 1.5	8	-04	47,5	1.87	24,1	0.95	4,2	0.16	17,0	0.67
1S6EK4	1G6EK4	1A6EK4	—	M18 x 1.5	10	-04	40,7	1.60	23,6	0.93	4,2	0.16	19,0	0.75
1S8EK6	1G8EK6	1A8EK6	1B8EK6	M20 x 1.5	12	-06	50,3	1.98	25,0	0.98	6,7	0.26	22,0	0.87
1S10EK6	1G10EK6	1A10EK6	1B10EK6	M22 x 1.5	14	-06	52,6	2.07	27,3	1.07	6,7	0.26	24,0	0.94
1S12EK8	1G12EK8	1A12EK8	1B12EK8	M24 x 1.5	16	-08	58,0	2.28	28,3	1.11	9,6	0.38	27,0	1.06
1S16EK10	1G16EK10	1A16EK10	1B16EK10	M30 x 2	20	-10	62,0	2.44	32,6	1.28	12,8	0.50	32,0	1.26
1S20EK12	1G20EK12	1A20EK12	1B20EK12	M36 x 2	25	-12	65,5	2.58	35,3	1.39	15,5	0.61	41,0	1.61
1S25EK16	1G25EK16	1A25EK16	1B25EK16	M42 x 2	30	-16	72,3	2.85	37,9	1.49	20,7	0.81	46,0	1.81

JIS Female Swivel (JF)

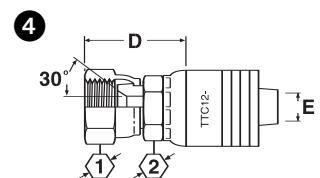
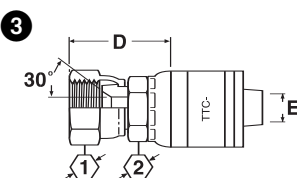
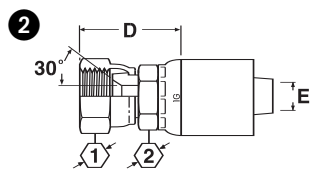
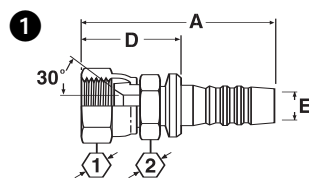

1 Nipple Part #	2 OTC Part #	3 TTC Part #	4 TTC12 Part #	Thd.	Hose Size	A		D		EØ		1	2		
						mm	in	mm	in	mm	in			mm	in
1S4JF4	1G4JF4	1A4JF4	—	G 1/4	-04	53,2	2.09	29,8	1.17	4,2	0.16	19,0	0.75	19,0	0.75
1S6JF6	1G6JF6	1A6JF6	1B6JF6	G 3/8	-06	59,2	2.33	33,9	1.33	6,7	0.26	22,0	0.87	22,0	0.87
1S8JF8	1G8JF8	1A8JF8	1B8JF8	G 1/2	-08	66,3	2.61	36,6	1.44	9,6	0.38	27,0	1.06	27,0	1.06
1S12JF12	1G12JF12	1A12JF12	1B12JF12	G 3/4	-12	73,3	2.88	43,1	1.70	15,5	0.61	32,0	1.26	36,0	1.42
1S16JF16	1G16JF16	1A16JF16	1B16JF16	G 1	-16	83,6	3.29	49,2	1.94	20,7	0.81	41,0	1.61	41,0	1.61
1S20JF20	1G20JF20	1AP20JF20*	1B20JF20	G 1 1/4	-20	102,1	4.02	58,1	2.29	26,6	1.05	50,0	1.97	46,0	1.81
—	—	1AT20JF20**	—	G 1 1/4	-20	102,1	4.02	58,1	2.29	26,6	1.05	50,0	1.97	46,0	1.81

* Uses 1-wire braid hose socket.

**Uses 2-wire braid hose socket.

Komatsu Female Swivel (KF)

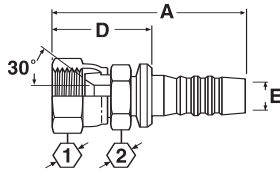

1

Global Nipples for use with Hose:
Clamp: 2661 (-12 thru -20), FC619 (-12 thru -20). **Socket 1SA:** 2681, FC194, FC211, FC310, FC510, FC639/FC839B (-4 thru -8), GH194 (-4 thru -20), GH663, GH681. **Socket 1SB:** 2781, FC195, FC212, FC466, FC498, FC598, FC579, FC639/FC839B (-10 thru -16), FC735 (-4 thru -20), FC849/FC849B (-06 thru -12), GH120 (-4 thru -20), GH195, GH781 (-04 thru -20), GH793, 2766.

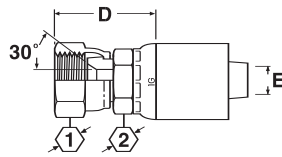

2

Global OTC Fittings for use with Hose: 2583, 2661, FC466, FC498, FC598, FC619, FC699

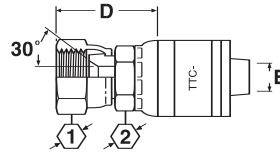

3

Global TTC Fittings for use with Hose: 2661(-12 thru -32), FC211, FC212, FC310, FC510, FC579, FC611, FC619 (-12 thru -32), FC639/FC839B, FC693, FC735, FC849/FC849B, GH120, GH194, GH195, GH663, GH681-6, GH781, GH793.

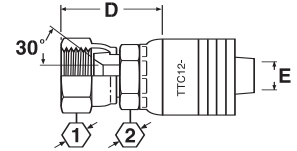

4

Global TTC12 Fittings for use with Hose: FC136, FC636, FC659, FC736, GH493.

1 Nipple Part #	2 OTC Part #	3 TTC Part #	4 TTC12 Part #	Thd.	Hose Size	A		D		EØ		①	②		
						mm	in	mm	in	mm	in	mm	in		
1S4KF4	1G4KF4	1A4KF4	—	M14 x 1.5	-04	56,1	2.21	32,7	1.29	42,2	1.66	19,0	0.75	19,0	0.75
1S6KF6	1G6KF6	1A6KF6	—	M18 x 1.5	-06	60,4	2.38	35,1	1.38	6,7	0.26	24,0	0.94	22,0	0.87
1S8KF8	1G8KF8	1A8KF8	—	M22 x 1.5	-08	69,5	2.74	39,8	1.57	9,6	0.38	27,0	1.06	27,0	1.06
1S10KF10	1G10KF10	1A10KF10	—	M24 x 1.5	-10	75,4	2.97	46,0	1.81	12,4	0.49	32,0	1.26	30,0	1.18
1S10KF12	1G10KF12	1A10KF12	—	M24 x 1.5	-12	76,6	3.01	46,4	1.83	12,4	0.49	32,0	1.26	30,0	1.18
1S12KF12	1G12KF12	1A12KF12	1B12KF12	M30 x 1.5	-12	81,5	3.21	51,3	2.02	15,5	0.61	36,0	1.42	36,0	1.42
1S16KF16	1G16KF16	1A16KF16	1B16KF16	M33 x 1.5	-16	91,4	3.60	57,0	2.24	20,7	0.81	41,0	1.61	41,0	1.61
1S20KF20	1G20KF20	1AP20KF20*	1B20KF20	M36 x 1.5	-20	113,4	4.46	69,4	2.73	26,6	1.05	46,0	1.81	46,0	1.81
—	—	1AT20KF20**	—	M36 x 1.5	-20	113,4	4.46	60,4	2.38	26,6	1.05	46,0	1.81	46,0	1.81

* Uses 1-wire braid hose socket.

**Uses 2-wire braid hose socket.

SPECIALTY & TRUCK HOSE

LOW & MEDIUM PRESSURE HOSE

HIGH PRESSURE HOSE

HOSE FITTINGS

ADAPTERS & TUBE FITTINGS

ACCESSORIES & ASSEMBLY INSTRUCTIONS

HOSE ASSEMBLY EQUIPMENT

APPENDICES

Komatsu Split Flange (KS)

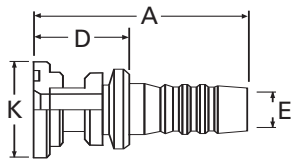

1
Global Nipples for use with Hose:
Clamp: 2661 (-12 thru -20), FC619 (-12 thru -20). **Socket 1SA:** 2681, FC194, FC211, FC310, FC510, FC639/FC839B (-4 thru -8), GH194 (-4 thru -20), GH663, GH681. **Socket 1SB:** 2781, FC195, FC212, FC466, FC498, FC598, FC579, FC639/FC839B (-10 thru -16), FC735 (-4 thru -20), FC849/FC849B (-06 thru -12), GH120 (-4 thru -20), GH195, GH781 (-04 thru -20), GH793, 2766.

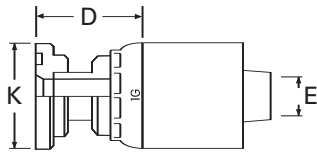

2
Global OTC Fittings for use with Hose: 2583, 2661, FC466, FC498, FC598, FC619, FC699

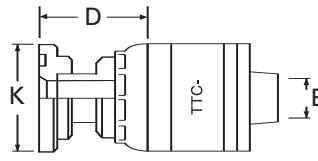

3
Global TTC Fittings for use with Hose: 2661(-12 thru -32), FC211, FC212, FC310, FC510, FC579, FC611, FC619 (-12 thru -32), FC639/FC839B, FC693, FC735, FC849/FC849B, GH120, GH194, GH195, GH663, GH681-6, GH781, GH793.

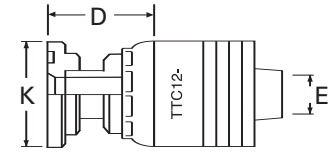

4
Global TTC12 Fittings for use with Hose: FC136, FC636, FC659, FC736, GH493.

1 Nipple Part #	2 OTC Part #	3 TTC Part #	4 TTC12 Part #	Flange Dia.	Hose Size	A		D		EØ	
						mm	in	mm	in	mm	in
1S10KS10	1G10KS10	1A10KS10	1B10KS10	34.2	-10	94,2	0.16	64,8	2.55	11,5	0.45

Komatsu Split Flange 45° Elbow (KSA)

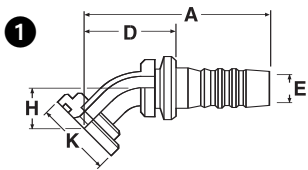

1
Nipple Part #
 1S10KSA10

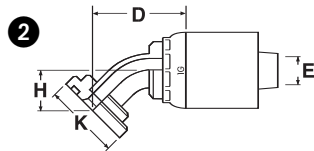

2
OTC Part #
 1G10KSA10

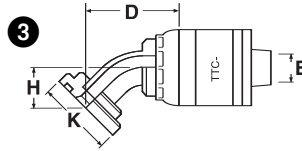

3
TTC Part #
 1A10KSA10

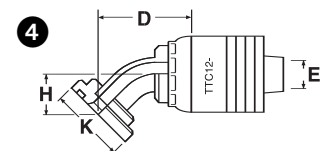

4
TTC12 Part #
 1B10KSA10

1 Nipple Part #	2 OTC Part #	3 TTC Part #	4 TTC12 Part #	Flange Dia.	Hose Size	A		D		EØ		H
						mm	in	mm	in	mm	in	mm
1S10KSA10	1G10KSA10	1A10KSA10	1B10KSA10	34.2	-10	86,1	3.39	56,7	2.23	11,5	0.45	21,8 0.86

Komatsu Split Flange 90° Elbow (KSB)

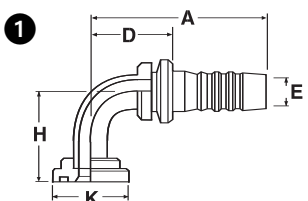

1
Nipple Part #
 1S10KSB10

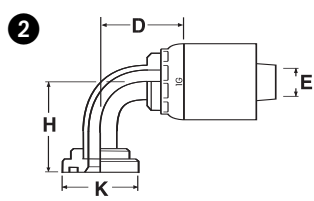

2
OTC Part #
 1G10KSB10

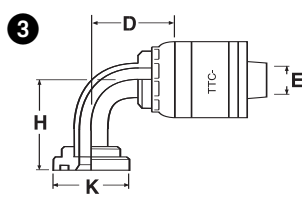

3
TTC Part #
 1A10KSB10

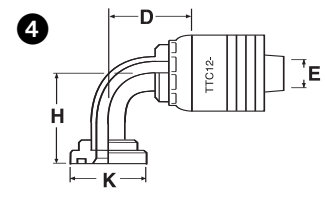

4
TTC12 Part #
 1B10KSB10

1 Nipple Part #	2 OTC Part #	3 TTC Part #	4 TTC12 Part #	Flange Dia.	Hose Size	A		D		EØ		H
						mm	in	mm	in	mm	in	mm
1S10KSB10	1G10KSB10	1A10KSB10	1B10KSB10	34.2	-10	77,9	3.07	48,5	1.91	11,5	0.45	51,3 2.02

* Uses 1-wire braid hose socket.
 **Uses 2-wire braid hose socket.

Global Spiral TTC Fittings

- Straight split flange -
- 45° split flange -
- 90° split flange -
- Code 62 (SAE J518)

Spiral TTC Fittings for use
with hose: FC254, FC273, FC273B,
FC606, FC606B, GH466, GH506
1E Fittings for use on 4-wire
construction
1Z Fittings for use on 6-wire
construction

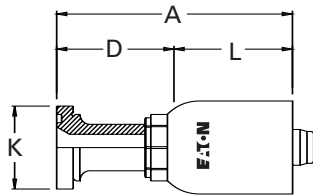

**Straight Split Flange
Code 62**

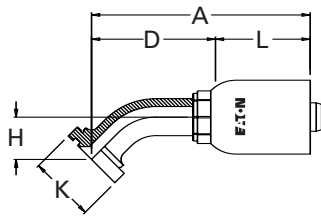

**45° Elbow Split Flange
Code 62**

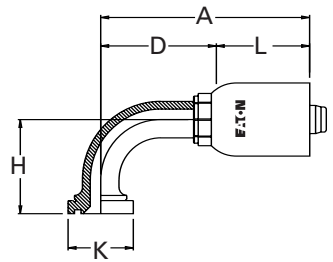

**90° Elbow Split Flange
Code 62**

Fitting Part Number	Flange Head Dia. K		Hose Size	A		D		Hose Insertion Length L		H	
	mm	in		mm	in	mm	in	mm	in	mm	in
Straight split flange – Code 62 (SAE J518)											
1E12FH12	41,3	1.62	-12	105,8	4.16	60,8	2.39	45,0	1.77		
1E16FH12	47,6	1.88	-12	110,0	4.33	65,0	2.56	45,0	1.77		
1E16FH16	47,6	1.88	-16	135,2	5.32	70,2	2.76	65,0	2.56		
1Z16FH16	47,6	1.88	-16	135,2	5.32	70,2	2.76	65,0	2.56		
1E20FH16	54,0	2.12	-16	132,6	5.22	67,6	2.66	65,0	2.56		
1E20FH20	54,0	2.12	-20	148,6	5.85	73,6	2.90	75,0	2.95		
1Z20FH16	54,0	2.12	-16	132,6	5.22	67,6	2.66	65,0	2.56		
1Z20FH20	54,0	2.12	-20	148,6	5.85	73,6	2.90	75,0	2.95		
1E24FH20	63,5	2.50	-20	185,6	7.31	110,6	4.35	75,0	2.95		
1Z24FH20	63,5	2.50	-20	185,6	7.31	110,6	4.35	75,0	2.95		
1E24FH24	63,5	2.50	-24	189,6	7.46	111,6	4.39	78,0	3.07		
1Z24FH24	63,5	2.50	-24	189,6	7.46	111,6	4.39	78,0	3.07		
1E32FH24	79,4	3.13	-24	200,6	7.90	122,6	4.83	78,0	3.07		
1Z32FH24	79,4	3.13	-24	200,6	7.90	122,6	4.83	78,0	3.07		
1E32FH32	79,4	3.13	-32	202,7	7.98	124,7	4.91	78,0	3.07		
1Z32FH32	79,4	3.13	-32	202,7	7.98	124,7	4.91	78,0	3.07		
45° Split flange - Code 62 (SAE J518)											
1E12FHA12	41,3	1.62	-12	125,3	4.93	80,3	3.16	45,0	1.77	27,0	1.06
1E16FHA12	47,6	1.88	-12	136,5	5.37	91,5	3.60	45,0	1.77	32,0	1.26
1E16FHA16	47,6	1.88	-16	161,7	6.37	96,7	3.81	65,0	2.56	32,0	1.26
1Z16FHA16	47,6	1.88	-16	161,7	6.37	96,7	3.81	65,0	2.56	32,0	1.26
1E20FHA16	54,0	2.12	-16	177,4	6.99	112,4	4.43	65,0	2.56	39,0	1.54
1E20FHA20	54,0	2.12	-20	193,4	7.61	118,4	4.66	75,0	2.95	39,0	1.54
1Z20FHA16	54,0	2.12	-16	177,4	6.99	112,4	4.43	65,0	2.56	39,0	1.54
1Z20FHA20	54,0	2.12	-20	193,4	7.61	118,4	4.66	75,0	2.95	39,0	1.54
1E24FHA20	63,5	2.50	-20	206,3	8.12	131,3	5.17	75,0	2.95	45,0	1.77
1Z24FHA20	63,5	2.50	-20	206,3	8.12	131,3	5.17	75,0	2.95	45,0	1.77
1E24FHA24	63,5	2.50	-24	210,3	8.28	132,3	5.21	78,0	3.07	45,0	1.77
1Z24FHA24	63,5	2.50	-24	210,3	8.28	132,3	5.21	78,0	3.07	45,0	1.77
1E32FHA24	79,4	3.13	-24	247,2	9.73	169,2	6.66	78,0	3.07	57,5	2.26
1Z32FHA24	79,4	3.13	-24	247,2	9.73	169,2	6.66	78,0	3.07	57,5	2.26
1E32FHA32	79,4	3.13	-32	249,3	9.81	171,3	6.74	78,0	3.07	57,5	2.26
1Z32FHA32	79,4	3.13	-32	249,3	9.81	171,3	6.74	78,0	3.07	57,5	2.26
90° Split flange - Code 62 (SAE J518)											
1E12FHB12	41,3	1.62	-12	120,0	4.72	75,0	2.95	45,0	1.77	59,0	2.32
1E16FHB12	47,6	1.88	-12	131,4	5.17	86,4	3.40	45,0	1.77	71,0	2.80
1E16FHB16	47,6	1.88	-16	156,6	6.17	91,6	3.61	65,0	2.56	71,0	2.80
1Z16FHB16	47,6	1.88	-16	156,6	6.17	91,6	3.61	65,0	2.56	71,0	2.80
1E20FHB16	54,0	2.12	-16	172,4	6.79	107,4	4.23	65,0	2.56	89,0	3.50
1E20FHB20	54,0	2.12	-20	188,4	7.41	113,4	4.46	75,0	2.95	89,0	3.50
1Z20FHB16	54,0	2.12	-16	172,4	6.79	107,4	4.23	65,0	2.56	89,0	3.50
1Z20FHB20	54,0	2.12	-20	188,4	7.41	113,4	4.46	75,0	2.95	89,0	3.50
1E24FHB20	63,5	2.50	-20	201,1	7.92	126,1	4.96	75,0	2.95	104,0	4.09
1Z24FHB20	63,5	2.50	-20	201,1	7.92	126,1	4.96	75,0	2.95	104,0	4.09
1E24FHB24	63,5	2.50	-24	205,1	8.07	127,1	5.00	78,0	3.07	104,0	4.09
1Z24FHB24	63,5	2.50	-24	205,1	8.07	127,1	5.00	78,0	3.07	104,0	4.09
1E32FHB24	79,4	3.13	-24	243,6	9.59	165,6	6.52	78,0	3.07	138,0	5.43
1Z32FHB24	79,4	3.13	-24	243,6	9.59	165,6	6.52	78,0	3.07	138,0	5.43
1E32FHB32	79,4	3.13	-32	245,7	9.67	167,7	6.60	78,0	3.07	138,0	5.43
1Z32FHB32	79,4	3.13	-32	245,7	9.67	167,7	6.60	78,0	3.07	138,0	5.43

NOTE: For flanges, split flange halves, kits and o-rings, see pages 190-194.

SPECIALTY & TRUCK HOSE
 LOW & MEDIUM PRESSURE HOSE
 HIGH PRESSURE HOSE
 HOSE FITTINGS
 ADAPTERS & TUBE FITTINGS
 ACCESSORIES & ASSEMBLY INSTRUCTIONS
 HOSE ASSEMBLY EQUIPMENT
 APPENDICES

Global Spiral TTC Fittings

Straight split flange -
45° split flange -
90° split flange -
Code 61 (SAE J518)

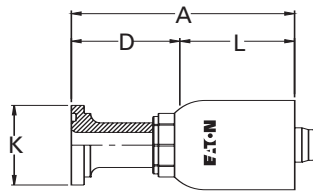

**Straight Split Flange
Code 61**

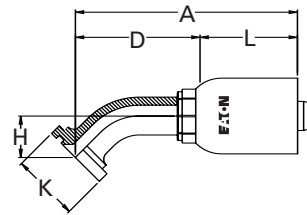

**45° Elbow Split Flange
Code 61**

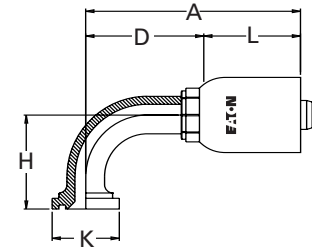

**90° Elbow Split Flange
Code 61**

Spiral TTC Fittings for use with hose: FC254, FC273, FC273B, FC606, FC606B, GH466, GH506

1E Fittings for use on 4-wire construction

1Z Fittings for use on 6-wire construction

Fitting Part Number	Flange Head Dia. K		Hose Size	A		D		Hose Insertion Length L		H	
	mm	in		mm	in	mm	in	mm	in	mm	in
Straight split flange - Code 61 (SAE J518)											
1E12FL12	38,1	1.50	-12	99,5	3.92	54,5	2.15	45,0	1.77		
1E16FL12	44,4	1.75	-12	96,1	3.78	51,1	2.01	45,0	1.77		
1E16FL16	44,4	1.75	-16	121,3	4.78	56,3	2.22	65,0	2.56		
1Z16FL16	44,4	1.75	-16	121,3	4.78	56,3	2.22	65,0	2.56		
1E20FL16	50,8	2.00	-16	125,5	4.94	60,5	2.38	65,0	2.56		
1E20FL20	50,8	2.00	-20	141,5	5.57	66,5	2.62	75,0	2.95		
1Z20FL20	50,8	2.00	-20	141,5	5.57	66,5	2.62	75,0	2.95		
1E24FL20	60,3	2.38	-20	163,8	6.45	88,8	3.50	75,0	2.95		
1E24FL24	60,3	2.38	-24	167,8	6.61	89,8	3.54	78,0	3.07		
1Z24FL24	60,3	2.38	-24	167,8	6.61	89,8	3.54	78,0	3.07		
1E32FL24	71,4	2.81	-24	170,9	6.73	92,9	3.66	78,0	3.07		
1E32FL32	71,4	2.81	-32	173,0	6.81	95,0	3.74	78,0	3.07		
1Z32FL32	71,4	2.81	-32	173,0	6.81	95,0	3.74	78,0	3.07		
45° Split flange - Code 61 (SAE J518)											
1E12FLA12	38,1	1.50	-12	125,3	4.93	80,3	3.16	45,0	1.77	27,0	1.06
1E16FLA12	44,4	1.75	-12	136,5	5.37	91,5	3.60	45,0	1.77	32,0	1.26
1E16FLA16	44,4	1.75	-16	161,7	6.37	96,7	3.81	65,0	2.56	32,0	1.26
1Z16FLA16	44,4	1.75	-16	161,7	6.37	96,7	3.81	65,0	2.56	32,0	1.26
1E20FLA16	50,8	2.00	-16	177,4	6.99	112,4	4.43	65,0	2.56	39,0	1.54
1E20FLA20	50,8	2.00	-20	193,4	7.61	118,4	4.66	75,0	2.95	39,0	1.54
1Z20FLA20	50,8	2.00	-20	193,4	7.61	118,4	4.66	75,0	2.95	39,0	1.54
1E24FLA20	60,3	2.38	-20	206,3	8.12	131,3	5.17	75,0	2.95	45,0	1.77
1E24FLA24	60,3	2.38	-24	210,3	8.28	132,3	5.21	78,0	3.07	45,0	1.77
1Z24FLA24	60,3	2.38	-24	210,3	8.28	132,3	5.21	78,0	3.07	45,0	1.77
1E32FLA24	71,4	2.81	-24	247,2	9.73	169,2	6.66	78,0	3.07	57,5	2.26
1E32FLA32	71,4	2.81	-32	249,3	9.81	171,3	6.74	78,0	3.07	57,5	2.26
1Z32FLA32	71,4	2.81	-32	249,3	9.81	171,3	6.74	78,0	3.07	57,5	2.26
90° Split flange - Code 61 (SAE J518)											
1E12FLB12	38,1	1.50	-12	120,0	4.72	75,0	2.95	45,0	1.77	59,0	2.32
1E16FLB12	44,4	1.75	-12	131,4	5.17	86,4	3.40	45,0	1.77	71,0	2.80
1E16FLB16	44,4	1.75	-16	156,6	6.17	91,6	3.61	65,0	2.56	71,0	2.80
1Z16FLB16	44,4	1.75	-16	156,6	6.17	91,6	3.61	65,0	2.56	71,0	2.80
1E20FLB16	50,8	2.00	-16	172,4	6.79	107,4	4.23	65,0	2.56	89,0	3.50
1E20FLB20	50,8	2.00	-20	188,4	7.41	113,4	4.46	75,0	2.95	89,0	3.50
1Z20FLB20	50,8	2.00	-20	188,4	7.41	113,4	4.46	75,0	2.95	89,0	3.50
1E24FLB20	60,3	2.38	-20	201,1	7.92	126,1	4.96	75,0	2.95	104,0	4.09
1E24FLB24	60,3	2.38	-24	205,1	8.07	127,1	5.00	78,0	3.07	104,0	4.09
1Z24FLB24	60,3	2.38	-24	205,1	8.07	127,1	5.00	78,0	3.07	104,0	4.09
1E32FLB24	71,4	2.81	-24	243,6	9.59	165,6	6.52	78,0	3.07	138,0	5.43
1E32FLB32	71,4	2.81	-32	245,7	9.67	167,7	6.60	78,0	3.07	138,0	5.43
1E32FLB32	71,4	2.81	-32	245,7	9.67	167,7	6.60	78,0	3.07	138,0	5.43

NOTE: For flanges, split flange halves, kits and o-rings, see pages 190-195.

SPECIALTY & TRUCK HOSE
 LOW & MEDIUM PRESSURE HOSE
 HIGH PRESSURE HOSE
 HOSE FITTINGS
 ADAPTERS & TUBE FITTINGS
 ACCESSORIES & ASSEMBLY INSTRUCTIONS
 HOSE ASSEMBLY EQUIPMENT
 APPENDICES

Global Spiral TTC Fittings

Spiral TTC Fittings for use with hose: FC254, FC273, FC273B, FC606, FC606B, GH466, GH506

1E Fittings for use on 4-wire construction

1Z Fittings for use on 6-wire construction

Compatible only with D-rings found on page 193.

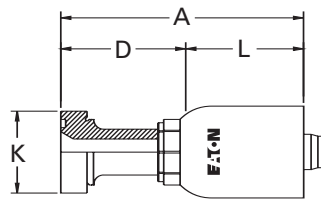

Cat Flange
Straight

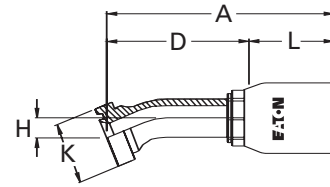

Cat Flange
22 1/2° Elbow

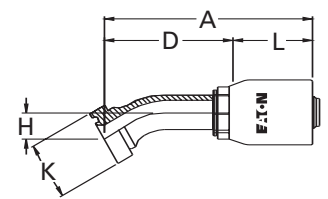

Cat Flange
30° Elbow

Fitting Part Number	Flange Head Dia. K		Hose Size	A		D		Hose Insertion Length L		H	
	mm	in		mm	in	mm	in	mm	in	mm	in
Caterpillar - Straight split flange											
1E12CT12	41,3	1.62	-12	111,3	4.38	66,3	2.61	45,0	1.77		
1E16CT12	47,6	1.88	-12	114,7	4.51	69,7	2.74	45,0	1.77		
1E16CT16	47,6	1.88	-16	139,9	5.51	74,9	2.95	65,0	2.56		
1Z16CT16	47,6	1.88	-16	139,9	5.51	74,9	2.95	65,0	2.56		
1E20CT16	54,0	2.12	-16	136,5	5.37	71,5	2.81	65,0	2.56		
1E20CT20	54,0	2.12	-20	152,5	6.00	77,5	3.05	75,0	2.95		
1Z20CT16	54,0	2.12	-16	136,5	5.37	71,5	2.81	65,0	2.56		
1Z20CT20	54,0	2.12	-20	152,5	6.00	77,5	3.05	75,0	2.95		
1Z24CT20	63,5	2.50	-20	187,3	7.37	112,3	4.42	75,0	2.95		
1Z24CT24	63,5	2.50	-24	191,3	7.53	113,3	4.46	78,0	3.07		
1Z32CT24	79,4	3.13	-24	202,3	7.96	124,3	4.89	78,0	3.07		
1Z32CT32	79,4	3.13	-32	204,4	8.05	126,4	4.98	78,0	3.07		
Caterpillar - 22 1/2° Split flange											
1E12CTD12	41,3	1.62	-12	137,9	5.43	92,9	3.66	45,0	1.77	13,7	0.54
1E16CTD16	47,6	1.88	-16	174,8	6.88	109,8	4.32	65,0	2.56	15,3	0.60
1Z16CTD16	47,6	1.88	-16	174,8	6.88	109,8	4.32	65,0	2.56	15,3	0.60
1E20CTD16	54,0	2.12	-16	191,9	7.56	126,9	5.00	65,0	2.56	17,8	0.70
1Z20CTD20	54,0	2.12	-20	207,9	8.19	132,9	5.23	75,0	2.95	17,8	0.70
1Z24CTD20	63,5	2.50	-20	220,1	8.67	145,1	5.71	75,0	2.95	19,4	0.76
1Z24CTD24	63,5	2.50	-24	224,1	8.82	146,1	5.75	78,0	3.07	19,4	0.76
Caterpillar - 30° Split flange											
1E12CTF12	41,3	1.62	-12	135,7	5.34	90,7	3.57	45,0	1.77	19,1	0.75
1E16CTF16	47,6	1.88	-16	172,4	6.79	107,4	4.23	65,0	2.56	21,6	0.85
1Z16CTF16	47,6	1.88	-16	172,4	6.79	107,4	4.23	65,0	2.56	21,6	0.85
1E20CTF16	54,0	2.12	-16	189,1	7.45	124,1	4.89	65,0	2.56	25,3	1.00
1Z20CTF20	54,0	2.12	-20	205,1	8.08	130,1	5.12	75,0	2.95	25,3	1.00
1Z24CTF20	63,5	2.50	-20	217,1	8.55	142,1	5.59	75,0	2.95	27,7	1.09
1Z24CTF24	63,5	2.50	-24	221,1	8.70	143,1	5.63	78,0	3.07	27,7	1.09
1Z32CTF24	79,4	3.13	-24	260,5	10.26	182,5	7.19	78,0	3.07	34,8	1.37
1Z32CTF32	79,4	3.13	-32	262,6	10.34	184,6	7.27	78,0	3.07	34,8	1.37

SPECIALTY &
TRUCK HOSE

LOW & MEDIUM
PRESSURE HOSE

HIGH PRESSURE HOSE

HOSE FITTINGS

ADAPTERS &
TUBE FITTINGS

ACCESSORIES &
ASSEMBLY INSTRUCTIONS

HOSE ASSEMBLY
EQUIPMENT

APPENDICES

Global Spiral TTC Fittings

Spiral TTC Fittings for use with hose: FC254, FC273, FC273B, FC606, FC606B, GH466, GH506

1E Fittings for use on 4-wire construction

1Z Fittings for use on 6-wire construction

Compatible only with D-rings found on page 193.

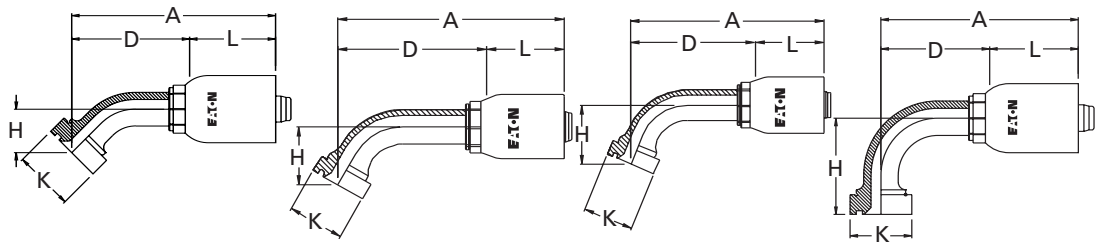

Cat Flange
45° Elbow

Cat Flange
60° Elbow

Cat Flange
67 1/2° Elbow

Cat Flange
90° Elbow

Fitting Part Number	Flange Head Dia. K		Hose Size	A		D		Hose Insertion Length L		H	
	mm	in		mm	in	mm	in	mm	in	mm	in
Caterpillar - 45° Split flange											
1E12CTA12	41,3	1.62	-12	129,2	5.08	84,2	3.31	45,0	1.77	30,9	1.22
1E16CTA12	47,6	1.88	-12	139,8	5.50	94,8	3.73	45,0	1.77	35,3	1.39
1E16CTA16	47,6	1.88	-16	165,0	6.50	100,0	3.94	65,0	2.56	35,3	1.39
1Z16CTA16	47,6	1.88	-16	165,0	6.50	100,0	3.94	65,0	2.56	35,3	1.39
1E20CTA16	54,0	2.12	-16	180,2	7.10	115,2	4.54	65,0	2.56	41,8	1.65
1E20CTA20	54,0	2.12	-20	196,2	7.72	121,2	4.77	75,0	2.95	41,8	1.65
1Z20CTA16	54,0	2.12	-16	180,2	7.10	115,2	4.54	65,0	2.56	41,8	1.65
1Z20CTA20	54,0	2.12	-20	196,2	7.72	121,2	4.77	75,0	2.95	41,8	1.65
1Z24CTA20	63,5	2.50	-20	207,5	8.17	132,5	5.22	75,0	2.95	46,2	1.82
1Z24CTA24	63,5	2.50	-24	211,5	8.33	133,5	5.26	78,0	3.07	46,2	1.82
1Z32CTA24	79,4	3.13	-24	248,4	9.78	170,4	6.71	78,0	3.07	58,7	2.31
1Z32CTA32	79,4	3.13	-32	250,5	9.86	172,5	6.79	78,0	3.07	58,7	2.31
Caterpillar - 60° Split flange											
1E12CTG12	41,3	1.62	-12	148,1	5.83	103,1	4.06	45,0	1.77	42,3	1.66
1E16CTG16	47,6	1.88	-16	189,3	7.45	124,3	4.89	65,0	2.56	48,7	1.92
1Z16CTG16	47,6	1.88	-16	189,3	7.45	124,3	4.89	65,0	2.56	48,7	1.92
1E20CTG16	54,0	2.12	-16	212,4	8.36	147,4	5.80	65,0	2.56	59,3	2.33
1Z20CTG20	54,0	2.12	-20	228,4	8.99	153,4	6.04	75,0	2.95	59,3	2.33
1Z24CTG20	63,5	2.50	-20	246,4	9.70	171,4	6.75	75,0	2.95	66,6	2.62
1Z24CTG24	63,5	2.50	-24	250,4	9.86	172,4	6.79	78,0	3.07	66,6	2.62
1Z32CTG24	79,4	3.13	-24	303,2	11.94	225,2	8.87	78,0	3.07	87,3	3.44
1Z32CTG32	79,4	3.13	-32	305,3	12.02	227,3	8.95	78,0	3.07	87,3	3.44
Caterpillar - 67 1/2° Split flange											
1E12CTE12	41,3	1.62	-12	142,2	5.60	97,2	3.83	45,0	1.77	48,2	1.90
1E16CTE16	47,6	1.88	-16	182,5	7.18	117,5	4.62	65,0	2.56	55,8	2.20
1Z16CTE16	47,6	1.88	-16	182,5	7.18	117,5	4.62	65,0	2.56	55,8	2.20
1E20CTE16	54,0	2.12	-16	204,1	8.04	139,1	5.48	65,0	2.56	68,1	2.68
1Z20CTE20	54,0	2.12	-20	220,1	8.67	145,1	5.71	75,0	2.95	68,1	2.68
1Z24CTE20	63,5	2.50	-20	237,0	9.33	162,0	6.38	75,0	2.95	76,8	3.02
Caterpillar - 90° Split flange											
1E12CTB12	41,3	1.62	-12	120,0	4.72	75,0	2.95	45,0	1.77	64,5	2.54
1E16CTB12	47,6	1.88	-12	131,4	5.17	86,4	3.40	45,0	1.77	75,7	2.98
1E16CTB16	47,6	1.88	-16	156,6	6.17	91,6	3.61	65,0	2.56	75,7	2.98
1Z16CTB16	47,6	1.88	-16	156,6	6.17	91,6	3.61	65,0	2.56	75,7	2.98
1E20CTB16	54,0	2.12	-16	172,4	6.79	107,4	4.23	65,0	2.56	92,9	3.66
1E20CTB20	54,0	2.12	-20	188,4	7.41	113,4	4.46	75,0	2.95	92,9	3.66
1Z20CTB16	54,0	2.12	-16	172,4	6.79	107,4	4.23	65,0	2.56	92,9	3.66
1Z20CTB20	54,0	2.12	-20	188,4	7.41	113,4	4.46	75,0	2.95	92,9	3.66
1Z24CTB20	63,5	2.50	-20	201,1	7.92	126,1	4.96	75,0	2.95	105,7	4.16
1Z24CTB24	63,5	2.50	-24	205,1	8.07	127,1	5.00	78,0	3.07	105,7	4.16
1Z32CTB24	79,4	3.13	-24	243,6	9.59	165,6	6.52	78,0	3.07	139,6	5.50
1Z32CTB32	79,4	3.13	-32	245,7	9.67	167,7	6.60	78,0	3.07	139,6	5.50

SPECIALTY & TRUCK HOSE
 LOW & MEDIUM PRESSURE HOSE
 HIGH PRESSURE HOSE
 HOSE FITTINGS
 ADAPTERS & TUBE FITTINGS
 ACCESSORIES & ASSEMBLY INSTRUCTIONS
 HOSE ASSEMBLY EQUIPMENT
 APPENDICES

Global Spiral TTC Fittings

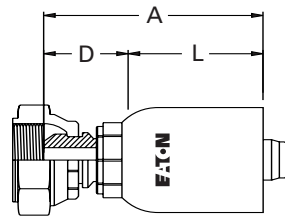

BSPP Swivel
Straight

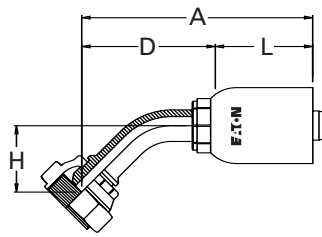

BSPP Swivel
45° Elbow

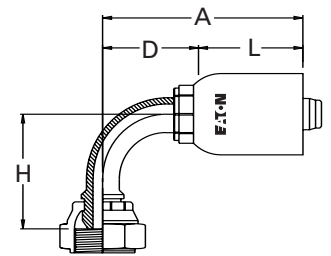

BSPP Swivel
90° Elbow

Spiral TTC Fittings for use with hose: FC254, FC273, FC273B, GH506

1E Fittings for use on 4-wire construction

1Z Fittings for use on 6-wire construction

Fitting Part Number	Thd.	Hose Size	A		D		Hose Insertion Length L		H	
			mm	in	mm	in	mm	in	mm	in
BSP/JIS Female swivel (BF)										
1E12BF12	G 3/4	-12	83,0	3.27	38,0	1.50	45,0	1.77		
1E16BF12	G 1	-12	81,7	3.22	36,7	1.44	45,0	1.77		
1E16BF16	G 1	-16	106,9	4.21	41,9	1.65	65,0	2.56		
1E20BF16	G 1 1/4	-16	104,9	4.13	39,9	1.57	65,0	2.56		
1E20BF20	G 1 1/4	-20	120,9	4.76	45,9	1.81	75,0	2.95		
1E24BF24	G 1 1/2	-24	153,5	6.04	75,5	2.97	78,0	3.07		
1Z24BF24	G 1 1/2	-24	153,5	6.04	75,5	2.97	78,0	3.07		
1E32BF32	G 2	-32	159,5	6.28	81,5	3.21	78,0	3.07		
1Z32BF32	G 2	-32	159,5	6.28	81,5	3.21	78,0	3.07		
BSP/JIS Female swivel, 45° elbow (BFA)										
1E12BFA12	G 3/4	-12	121,0	4.76	76,0	2.99	45,0	1.77	26,0	1.02
1E16BFA12	G 1	-12	130,4	5.13	85,4	3.36	45,0	1.77	30,0	1.18
1E16BFA16	G 1	-16	155,6	6.13	90,6	3.57	65,0	2.56	30,0	1.18
1E20BFA16	G 1 1/4	-16	166,9	6.57	101,9	4.01	65,0	2.56	34,0	1.34
1E20BFA20	G 1 1/4	-20	182,6	7.19	107,9	4.25	75,0	2.95	34,0	1.34
1E24BFA24	G 1 1/2	-24	208,2	8.20	130,2	5.13	78,0	3.07	43,0	1.69
1Z24BFA24	G 1 1/2	-24	208,2	8.20	130,2	5.13	78,0	3.07	43,0	1.69
1E32BFA32	G 2	-32	242,8	9.56	164,8	6.49	78,0	3.07	51,0	2.01
1Z32BFA32	G 2	-32	242,8	9.56	164,8	6.49	78,0	3.07	51,0	2.01
BSP/JIS Female swivel, 90° elbow (BFB)										
1E12BFB12	G 3/4	-12	114,5	4.51	69,5	2.74	45,0	1.77	57,0	2.24
1E16BFB12	G 1	-12	125,6	4.94	80,6	3.17	45,0	1.77	68,0	2.68
1E16BFB16	G 1	-16	150,8	5.94	85,8	3.38	65,0	2.56	68,0	2.68
1E20BFB16	G 1 1/4	-16	163,7	6.44	98,7	3.89	65,0	2.56	79,0	3.11
1E20BFB20	G 1 1/4	-20	179,7	7.07	104,7	4.12	75,0	2.95	79,0	3.11
1E24BFB24	G 1 1/2	-24	205,1	8.07	127,1	5.00	78,0	3.07	104,0	4.09
1Z24BFB24	G 1 1/2	-24	205,1	8.07	127,1	5.00	78,0	3.07	104,0	4.09
1E32BFB32	G 2	-32	245,7	9.67	167,7	6.60	78,0	3.07	133,0	5.24
1Z32BFB32	G 2	-32	245,7	9.67	167,7	6.60	78,0	3.07	133,0	5.24

NOTE: The JIS parallel thread and BSPP connection are interchangeable.

SPECIALTY &
TRUCK HOSE

LOW & MEDIUM
PRESSURE HOSE

HIGH PRESSURE HOSE

HOSE FITTINGS

ADAPTERS &
TUBE FITTINGS

ACCESSORIES &
ASSEMBLY INSTRUCTIONS

HOSE ASSEMBLY
EQUIPMENT

APPENDICES

Global Spiral TTC Fittings

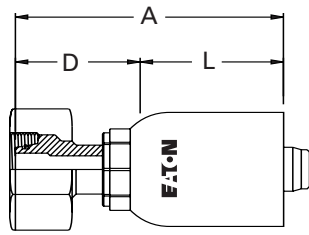

DKOS Swivel
Straight

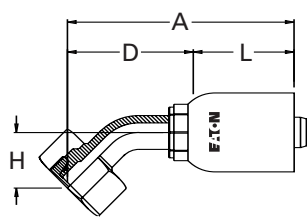

DKOS Swivel
45° Elbow

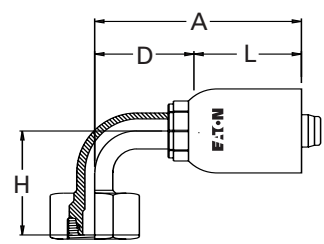

DKOS Swivel
90° Elbow

Spiral TTC Fittings for use with hose: FC254, FC273, FC273B, FC606, FC606B, GH466, GH506

1E Fittings for use on 4-wire construction

1Z Fittings for use on 6-wire construction

Fitting Part Number	Thd.	Tube O.D.	Hose Size	A		D		Hose Insertion Length L		H	
				mm	in	mm	in	mm	in	mm	in
DKO Female swivel, heavy duty (DS)											
1E20DS12	M36 x 2	25	-12	98,4	2.10	53,4	3.87	45,0	1.77		
1E25DS12	M42 x 2	30	-12	96,6	3.80	51,6	2.03	45,0	1.77		
1E25DS16	M42 x 2	30	-16	121,8	4.80	56,8	2.24	65,0	2.56		
1Z25DS16	M42 x 2	30	-16	121,8	4.80	56,8	2.24	65,0	2.56		
1E32DS16	M52 x 2	38	-16	122,3	4.82	57,3	2.26	65,0	2.56		
1E32DS20	M52 x 2	38	-20	138,3	5.44	63,3	2.49	75,0	2.95		
1Z32DS16	M52 x 2	38	-16	122,3	4.82	57,3	2.26	65,0	2.56		
1Z32DS20	M52 x 2	38	-20	138,3	5.44	63,3	2.49	75,0	2.95		
DKO Female swivel, heavy duty, 45° elbow (DSA)											
1E20DSA12	M36 x 2	25	-12	130,3	5.13	85,3	3.36	45,0	1.77	32,0	1.26
1E25DSA12	M42 x 2	30	-12	139,4	5.49	94,4	3.72	45,0	1.77	35,0	1.38
1E25DSA16	M42 x 2	30	-16	164,6	6.48	99,6	3.92	65,0	2.56	35,0	1.38
1Z25DSA16	M42 x 2	30	-16	164,6	6.48	99,6	3.92	65,0	2.56	35,0	1.38
1E32DSA16	M52 X 2	38	-16	177,3	6.98	112,3	4.42	65,0	2.56	39,0	1.54
1E32DSA20	M52 x 2	38	-20	193,3	7.61	118,3	4.66	75,0	2.95	39,0	1.54
1Z32DSA16	M52 X 2	38	-16	177,3	6.98	112,3	4.42	65,0	2.56	39,0	1.54
1Z32DSA20	M52 x 2	38	-20	193,3	7.61	118,3	4.66	75,0	2.95	39,0	1.54
DKO Female swivel, heavy duty, 90° elbow (DSB)											
1E20DSB12	M36 x 2	25	-12	120,0	4.72	75,0	2.95	45,0	1.77	65,0	2.56
1E25DSB12	M42 X 2	30	-12	131,4	5.19	86,4	3.40	45,0	1.77	76,0	2.99
1E25DSB16	M42 x 2	30	-16	156,8	6.17	91,8	3.61	65,0	2.56	76,0	2.99
1Z25DSB16	M42 x 2	30	-16	156,8	6.17	91,8	3.61	65,0	2.56	76,0	2.99
1E32DSB16	M52 X 2	38	-16	172,4	6.79	107,4	4.23	65,0	2.56	89,0	3.50
1E32DSB20	M52 x 2	38	-20	188,4	7.41	113,4	4.46	75,0	2.95	89,0	3.50
1Z32DSB16	M52 x 2	38	-16	172,4	6.79	107,4	4.23	65,0	2.56	89,0	3.50
1Z32DSB20	M52 x 2	38	-20	188,4	7.41	113,4	4.46	75,0	2.95	89,0	3.50

Global Spiral TTC Fittings

Spiral TTC Fittings for use with hose: FC254, FC273, FC273B, FC606, FC606B, GH466, GH506

1E Fittings for use on 4-wire construction

1Z Fittings for use on 6-wire construction

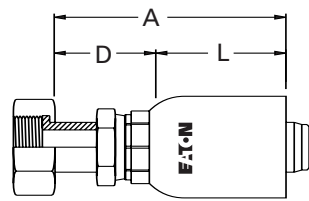

ORS Swivel
Straight

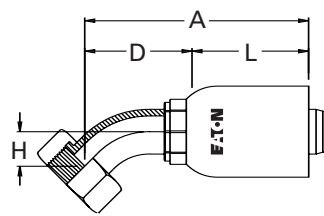

ORS Swivel
45° Elbow

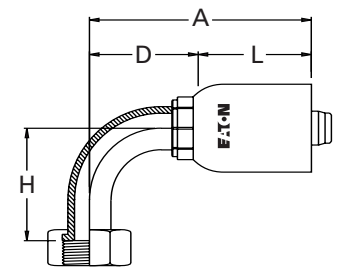

ORS Swivel
90° Elbow

Fitting Part Number	Thd.	Hose Size	A		D		Hose Insertion Length L		H	
			mm	in	mm	in	mm	in	mm	in
Female ORS swivel, straight										
1EA12FR12	1 ³ / ₁₆ -12	-12	95,9	3.77	50,9	2.00	45,0	1.77		
1EA16FR12	1 ⁷ / ₁₆ -12	-12	84,6	3.33	39,6	1.56	45,0	1.77		
1EA16FR16	1 ⁷ / ₁₆ -12	-16	119,5	4.71	54,5	2.15	65,0	2.56		
1ZA16FR16	1 ⁷ / ₁₆ -12	-16	119,5	4.71	54,5	2.15	65,0	2.56		
1EA20FR16	1 ¹¹ / ₁₆ -12	-16	106,4	4.19	41,4	1.63	65,0	2.56		
1EA20FR20	1 ¹¹ / ₁₆ -12	-20	136,7	5.38	61,7	2.43	75,0	2.95		
1EA24FR24	2-12	-24	126,9	5.00	48,9	1.93	78,0	3.07		
1ZA20FR16	1 ¹¹ / ₁₆ -12	-16	106,4	4.19	41,4	1.63	65,0	2.56		
1ZA20FR20	1 ¹¹ / ₁₆ -12	-20	136,7	5.38	61,7	2.43	75,0	2.95		
1ZA24FR24	2-12	-24	126,9	5.00	48,9	1.93	78,0	3.07		
Female ORS swivel, 45° elbow										
1EA12FRA12	1 ³ / ₁₆ -12	-12	118,9	4.68	73,9	2.91	45,0	1.77	24,0	0.94
1EA16FRA12	1 ⁷ / ₁₆ -12	-12	128,4	5.05	83,4	3.28	45,0	1.77	28,0	1.10
1EA16FRA16	1 ⁷ / ₁₆ -12	-16	153,4	6.04	88,4	3.48	65,0	2.56	28,0	1.10
1ZA16FRA16	1 ⁷ / ₁₆ -12	-16	153,4	6.04	88,4	3.48	65,0	2.56	28,0	1.10
1EA20FRA16	1 ¹¹ / ₁₆ -12	-16	163,9	6.45	98,9	3.89	65,0	2.56	31,0	1.22
1EA20FRA20	1 ¹¹ / ₁₆ -12	-20	179,8	7.08	104,8	4.13	75,0	2.95	31,0	1.22
1ZA20FRA16	1 ¹¹ / ₁₆ -12	-16	163,9	6.45	98,9	3.89	65,0	2.56	31,0	1.22
1ZA20FRA20	1 ¹¹ / ₁₆ -12	-20	179,8	7.08	104,8	4.13	75,0	2.95	31,0	1.22
Female ORS swivel, 90° elbow										
1EA12FRB12	1 ³ / ₁₆ -12	-12	114,5	4.51	69,5	2.74	45,0	1.77	58,0	2.28
1EA16FRB12	1 ⁷ / ₁₆ -12	-12	125,6	4.94	80,6	3.17	45,0	1.77	71,0	2.80
1EA16FRB16	1 ⁷ / ₁₆ -12	-16	150,6	5.93	85,6	3.37	65,0	2.56	71,0	2.80
1ZA16FRB16	1 ⁷ / ₁₆ -12	-16	150,6	5.93	85,6	3.37	65,0	2.56	71,0	2.80
1EA20FRB16	1 ¹¹ / ₁₆ -12	-16	163,7	6.45	98,7	3.89	65,0	2.56	78,0	3.07
1EA20FRB20	1 ¹¹ / ₁₆ -12	-20	179,6	7.07	104,6	4.12	75,0	2.95	78,0	3.07
1ZA20FRB16	1 ¹¹ / ₁₆ -12	-16	163,7	6.45	98,7	3.89	65,0	2.56	78,0	3.07
1ZA20FRB20	1 ¹¹ / ₁₆ -12	-20	179,6	7.07	104,6	4.12	75,0	2.95	84,0	3.07

SPECIALTY &
TRUCK HOSE

LOW & MEDIUM
PRESSURE HOSE

HIGH PRESSURE HOSE

HOSE FITTINGS

ADAPTERS &
TUBE FITTINGS

ACCESSORIES &
ASSEMBLY INSTRUCTIONS

HOSE ASSEMBLY
EQUIPMENT

APPENDICIES

Global Spiral TTC Fittings

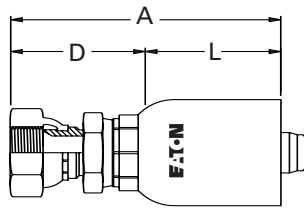

SAE 37° (JIC) Swivel
Straight

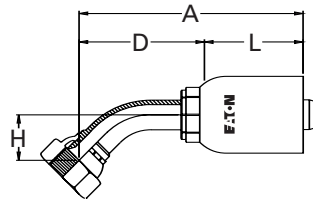

SAE 37° (JIC) Swivel
45° Elbow

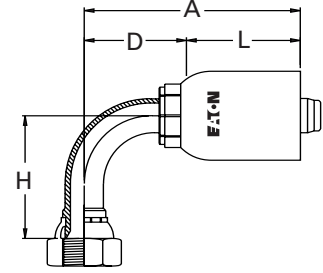

SAE 37° (JIC) Swivel
90° Elbow

Spiral TTC Fittings for use with hose: FC254, FC273, FC273B, FC606, FC606B, GH466, GH506

1E Fittings for use on 4-wire construction

1Z Fittings for use on 6-wire construction

Fitting Part Number	Thd.	Hose Size	A		D		Hose Insertion Length L		H	
			mm	in	mm	in	mm	in	mm	in
SAE 37° (JIC) Swivel										
1EA12FJ12	1 ¹ / ₁₆ -12	-12	104,2	4.10	59,2	2.33	45,0	1.77		
1EA16FJ12	5 ⁵ / ₁₆ -12	-12	106,6	4.20	61,6	2.43	45,0	1.77		
1EA16FJ16	5 ⁵ / ₁₆ -12	-16	131,8	5.19	66,8	2.63	65,0	2.56		
1ZA16FJ16	5 ⁵ / ₁₆ -12	-16	131,8	5.19	66,8	2.63	65,0	2.56		
1EA20FJ16	5 ⁵ / ₈ -12	-16	133,7	5.26	68,7	2.70	65,0	2.56		
1EA20FJ20	5 ⁵ / ₈ -12	-20	149,7	5.89	74,7	2.94	75,0	2.95		
1ZA20FJ20	5 ⁵ / ₈ -12	-20	149,7	5.89	74,7	2.94	75,0	2.95		
1EA24FJ20	7 ⁷ / ₈ -12	-20	167,5	6.59	92,5	3.64	75,0	2.95		
1ZA24FJ20	7 ⁷ / ₈ -12	-20	167,5	6.59	92,5	3.64	75,0	2.95		
1EA24FJ24	7 ⁷ / ₈ -12	-24	171,5	6.75	93,5	3.68	78,0	3.07		
1ZA24FJ24	7 ⁷ / ₈ -12	-24	171,5	6.75	93,5	3.68	78,0	3.07		
1EA32FJ32	2 ¹ / ₂ -12	-32	186,0	7.32	108,0	4.25	78,0	3.07		
1ZA32FJ32	2 ¹ / ₂ -12	-32	186,0	7.32	108,0	4.25	78,0	3.07		
SAE 37° (JIC) Swivel, 45° elbow										
1EA12FJA12	1 ¹ / ₁₆ -12	-12	121,9	4.80	76,9	3.03	45,0	1.77	27,0	1.06
1EA16FJA12	5 ⁵ / ₁₆ -12	-12	133,4	5.25	88,4	3.48	45,0	1.77	33,0	1.30
1EA16FJA16	5 ⁵ / ₁₆ -12	-16	158,6	6.25	93,6	3.69	65,0	2.56	33,0	1.30
1EA20FJA16	5 ⁵ / ₈ -12	-16	170,2	6.70	105,2	4.14	65,0	2.56	37,0	1.46
1EA20FJA20	5 ⁵ / ₈ -12	-20	186,2	7.33	111,2	4.38	75,0	2.95	37,0	1.46
1ZA20FJA20	5 ⁵ / ₈ -12	-20	186,2	7.33	111,2	4.38	75,0	2.95	37,0	1.46
1EA24FJA24	7 ⁷ / ₈ -12	-24	208,2	8.20	130,2	5.13	78,0	3.07	43,0	1.69
1ZA24FJA24	7 ⁷ / ₈ -12	-24	208,2	8.20	130,2	5.13	78,0	3.07	43,0	1.69
SAE 37° (JIC) Swivel, 90° elbow										
1EA12FJB12	1 ¹ / ₁₆ -12	-12	114,5	4.51	69,5	2.74	45,0	1.77	58,0	2.28
1EA16FJB12	5 ⁵ / ₁₆ -12	-12	125,6	4.94	80,6	3.17	45,0	1.77	71,0	2.80
1EA16FJB16	5 ⁵ / ₁₆ -12	-16	150,8	5.94	85,8	3.38	65,0	2.56	71,0	2.80
1EA20FJB16	5 ⁵ / ₈ -12	-16	163,9	6.45	98,9	3.89	65,0	2.56	82,0	3.23
1EA20FJB20	5 ⁵ / ₈ -12	-20	179,9	7.08	104,9	4.13	75,0	2.95	82,0	3.23
1ZA20FJB20	5 ⁵ / ₈ -12	-20	179,9	7.08	104,9	4.13	75,0	2.95	82,0	3.23
1EA24FJB24	7 ⁷ / ₈ -12	-24	205,1	8.07	127,1	5.00	78,0	3.07	104,0	4.09
1ZA24FJB24	7 ⁷ / ₈ -12	-24	205,1	8.07	127,1	5.00	78,0	3.07	104,0	4.09

SPECIALTY & TRUCK HOSE
LOW & MEDIUM PRESSURE HOSE
HIGH PRESSURE HOSE
HOSE FITTINGS
ADAPTERS & TUBE FITTINGS
ACCESSORIES & ASSEMBLY INSTRUCTIONS
HOSE ASSEMBLY EQUIPMENT
APPENDICES

Global Spiral TTC Fittings

Spiral TTC Fittings for use with hose: FC254, FC273, FC273B, FC606, FC606B, GH466, GH506

1E Fittings for use on 4-wire construction

1Z Fittings for use on 6-wire construction

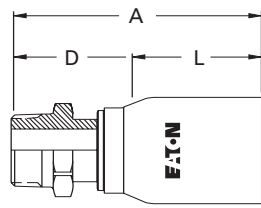

Male Pipe

Fitting Part Number	Thd.	Hose Size	A		D		Hose Insertion Length L		HEX
			mm	in	mm	in	mm	in	
Male Pipe (MP)									
1EA12MP12	3/4-14 NPTF	-12	98,7	3.89	53,7	2.12	45,0	1.77	1 1/4
1EA16MP16	1-11 1/2 NPTF	-16	125,4	4.94	60,4	2.38	65,0	2.55	1 1/2
1ZA16MP16	1-11 1/2 NPTF	-16	125,4	4.94	60,4	2.38	65,0	2.55	1 1/2
1EA20MP20	1 1/4-11 1/2 NPTF	-20	144,8	5.70	69,8	2.75	75,0	2.95	1 7/8
1ZA20MP20	1 1/4-11 1/2 NPTF	-20	144,8	5.70	69,8	2.75	75,0	2.95	1 7/8
1EA24MP24	1 1/2-11 1/2 NPTF	-24	150,6	5.93	72,6	2.86	78,0	3.07	2
1ZA24MP24	1 1/2-11 1/2 NPTF	-24	150,6	5.93	72,6	2.86	78,0	3.07	2
1EA32MP32	2-11 1/2 NPTF	-32	153,2	6.03	75,2	2.96	78,0	3.07	2 5/8
1ZA32MP32	2-11 1/2 NPTF	-32	153,2	6.03	75,2	2.96	78,0	3.07	2 5/8
Male Pipe (AP)*									
1EA12AP12	3/4-14 API	-12	109,4	4.31	64,5	2.54	45,0	1.77	1 1/4
1EA16AP16	1-11 1/2 API	-16	136,0	5.36	71,1	2.80	65,0	2.56	1 1/2
1EA20AP20	1 1/4-11 1/2 API	-20	155,3	6.12	80,5	3.17	75,0	2.95	1 7/8
1ZA20AP20	1 1/4-11 1/2 API	-20	155,3	6.12	80,5	3.17	75,0	2.95	1 7/8
1EA24AP24	1 1/2-11 1/2 API	-24	161,2	6.35	83,2	3.28	78,0	3.07	2
1ZA24AP24	1 1/2-11 1/2 API	-24	161,2	6.35	83,2	3.28	78,0	3.07	2
1EA32AP32	2-11 1/2* API	-32	164,2	6.47	86,2	3.40	78,0	3.07	2 5/8
1ZA32AP32	2-11 1/2* API	-32	164,2	6.47	86,2	3.40	78,0	3.07	2 5/8

*Conforms to API 5B thread standard for male pipe fittings.

Spiral Single Skive Crimp Fittings

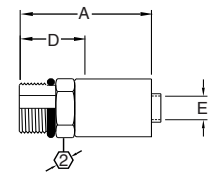
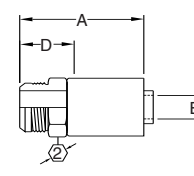
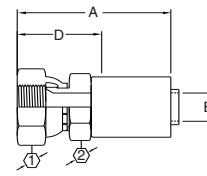
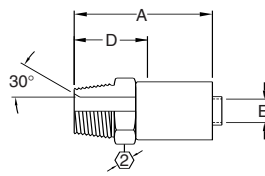

Spiral Single Skive Crimp Fittings for use with hose:
 FC736 (-06 thru -20), FC136, FC254 (-20, -24), FC323 (-12, -16, -20, -24), FC324 (-12, -16), GH493

Male Pipe
 FC9516/FJ9759
 FJ9568

SAE 37° (JIC) Swivel
 FC9515/FJ9760
 FJ9567

SAE 37° (JIC) Male flare
 FC9631/FJ9915

SAE Straight Thread O-ring male
 FC9712/FJ9916

Complete Fitting Part #	Component Part Numbers		Thd.	Hose Size	A		D		EØ		H	①	②
	Nipple Assy. Part #	Socket Part #			mm	in	mm	in	mm	in			
Male pipe													
FC9516-0406S	186101-4-6S	FC3471-06S	1/4-18	-06	62,0	2.44	31,5	1.24	6,6	.26			11/16
FC9516-0606S	186101-6-6S	FC3471-06S	3/8-18	-06	62,0	2.44	31,5	1.24	6,6	.26			11/16
FC9516-0806S	186101-8-6S	FC3471-06S	1/2-14	-06	62,0	2.44	31,5	1.24	6,6	.26			7/8
FC9516-0408S	186101-4-8S	FC3471-08S	1/4-18	-08	66,0	2.60	31,8	1.25	7,6	.30			13/16
FC9516-0608S	186101-6-8S	FC3471-08S	3/8-18	-08	66,0	2.60	31,8	1.25	9,7	.38			13/16
FC9516-0808S	186101-8-8S	FC3471-08S	1/2-14	-08	72,1	2.84	38,1	1.50	9,7	.38			7/8
FC9516-1208S	186101-12-8S	FC3471-08S	3/4-14	-08	66,0	2.60	31,8	1.25	9,7	.38			1 1/16
FC9516-0810S	186101-8-10S	FC3471-10S	1/2-14	-10	76,2	3.00	38,9	1.53	12,7	.50			1
FJ9759-1212S	FC1411-1212S	FC1410-12S	3/4-14	-12	85,9	3.38	42,2	1.66	15,5	.61			1 1/8
FJ9759-1616S	FC1411-1616S	FC1410-16S	1-11 1/2	-16	95,5	3.76	47,2	1.86	19,8	.78			1 3/8
FJ9759-2020S	*	*	1 1/4-11 1/2	-20	121,4	4.78	54,1	2.13	26,7	1.05			1 13/16
FJ9759-2424S	*	*	1 1/2-11 1/2	-24	131,3	5.17	56,9	2.24	32,0	1.26			2
FJ9568-3232S	*	*	2-11 1/2	-32	145,0	5.71	69,7	2.35	42,3	1.69			2 5/8
SAE 37° (JIC) swivel													
FC9515-0606S	186100H6-6S	FC3471-06S	9/16-18	-06	67,1	2.64	36,6	1.44	6,6	.26		11/16	11/16
FC9515-0806S	186100H8-6S	FC3471-06S	3/4-16	-06	69,6	2.74	39,1	1.54	6,6	.26		7/8	11/16
FC9515-0808S	186100H8-8S	FC3471-08S	3/4-16	-08	73,7	2.90	39,4	1.55	9,7	.38		7/8	13/16
FC9515-1008S	186100H10-8S	FC3471-08S	7/8-14	-08	76,5	3.01	42,2	1.66	9,7	.38		1	13/16
FC9515-1208S	186100H12-8S	FC3471-08S	1 1/16-12	-08	72,4	2.85	38,1	1.50	9,7	.38		1 1/4	1
FC9515-1010S	186100H10-10S	FC3471-10S	7/8-14	-10	81,8	3.22	44,7	1.76	12,7	.50		1	1
FC9515-1210S	186100H12-10S	FC3471-10S	1 1/16-12	-10	82,6	3.25	45,2	1.78	12,7	.50		1 1/4	1
FJ9760-1212S	FJ8760-1212S	FC1410-12S	1 1/16-12	-12	89,7	3.53	45,7	1.80	15,5	.61		1 1/4	1 1/16
FJ9760-1612S	FJ8760-1612S	FC1410-12S	1 5/16-12	-12	95,5	3.76	51,8	2.04	15,5	.61		1 1/2	1 1/4
FJ9760-1616S	FJ8760-1616S	FC1410-16S	1 5/16-12	-16	96,8	3.81	48,8	1.92	19,8	.78		1 1/2	1 1/4
FJ9760-2020S	*	*	1 5/8-12	-20	113,8	4.48	46,5	1.83	26,7	1.05			2
FJ9760-2424S	*	*	1 7/8-12	-24	125,0	4.92	50,8	2.00	32,0	1.26			2 1/4
FJ9567-3232S	*	*	2 1/2-12	-32	144,3	5.68	59,2	2.33	42,3	1.69			2 7/8
SAE 37° (JIC) male flare													
FC9631-0606S	186103-6-6S	FC3471-06S	9/16-18	-06	61,7	2.43	31,5	1.24	6,6	.26			11/16
FC9631-0806S	186103-8-6S	FC3471-06S	3/4-16	-06	64,3	2.53	34,0	1.34	6,6	.26			13/16
FC9631-0808S	186103-8-8S	FC3471-08S	3/4-16	-08	68,3	2.69	34,3	1.35	9,7	.38			13/16
FC9631-1008S	186103-10-8S	FC3471-08S	7/8-14	-08	72,4	2.85	38,4	1.51	9,7	.38			15/16
FC9631-1208S	186103-12-8S	FC3471-08S	1 1/16-12	-08	70,6	2.78	36,3	1.43	9,7	.38			1 1/8
FC9631-1010S	186103-10-10S	FC3471-10S	7/8-14	-10	76,2	3.00	39,1	1.54	12,2	.48			1
FC9631-1210S	186103-12-10S	FC3471-10S	1 1/16-12	-10	74,4	2.93	37,1	1.46	12,7	.50			1 1/8
FJ9915-1212S	FC1474-1212S	FC1410-12S	1 1/16-12	-12	88,6	3.49	45,0	1.77	15,5	.61			1 1/8
FJ9915-1612S	FC1474-1612S	FC1410-12S	1 5/16-12	-12	83,8	3.30	40,1	1.58	15,5	.61			1 3/8
FJ9915-1616S	FC1474-1616S	FC1410-16S	1 5/16-12	-16	96,0	3.78	47,8	1.88	19,8	.78			1 3/8
SAE O-Ring male, see pages 190-195 for o-rings													
FC9712-0606S	186121-6-6S	FC3471-06S	9/16-18	-06	57,7	2.27	27,2	1.07	6,6	.26			11/16
FC9712-0806S	186121-8-6S	FC3471-06S	3/4-16	-06	53,8	2.12	23,6	.93	6,6	.26			7/8
FC9712-0808S	186121-8-8S	FC3471-08S	3/4-16	-08	64,3	2.53	30,2	1.19	9,7	.38			7/8
FC9712-1008S	186121-10-8S	FC3471-08S	7/8-14	-08	69,7	2.35	25,4	1.00	9,7	.38			1
FC9712-1010S	186121-10-10S	FC3471-10S	7/8-14	-10	69,6	2.74	32,5	1.28	12,7	.50			1
FC9712-1210S	186121-12-10S	FC3471-10S	1 1/16-12	-10	67,6	2.66	30,2	1.19	12,7	.50			1 1/4
FJ9916-1212S	FC1475-1212S	FC1410-12S	1 1/16-12	-12	81,8	3.22	38,1	1.50	15,5	.61			1 1/4
FJ9916-1616S	FC1475-1616S	FC1410-16S	1 5/16-12	-16	87,9	3.46	39,9	1.57	19,8	.78			1 1/2

*Complete fittings are one-piece assemblies.

Spiral Single Skive Crimp Fittings

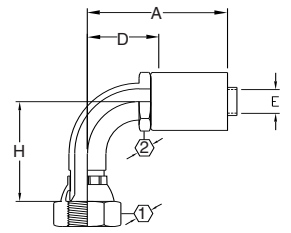
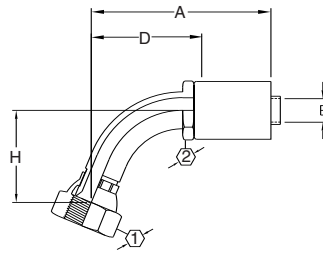
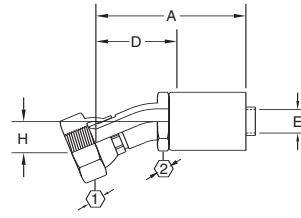

For use with hose: FC736 (-06 thru -20), FC136, FC254 (-20, -24), FC323 (-12, -16, -20, -24), FC324 (-12, -16), GH493

SAE 37° (JIC) Swivel
 FC5963/FJ9775 22½° elbow
 FC5965/FJ9776 30° elbow
 FC9627/FJ9777 45° elbow

SAE 37° (JIC) Swivel
 FC5967/FJ9778 60° elbow
 FC5969/FJ9779 67½° elbow

SAE 37° (JIC) Swivel
 FC9625/FJ9780 90° elbow

Complete Fitting Part #	Component Part Numbers		Thd.	Hose Size	A		D		EØ		H		①	②
	Nipple Assy. Part #	Socket Part #			mm	in	mm	in	mm	in	mm	in		
22½° Elbow														
FC5963-0808S	FC4963-0808S	FC3471-08S	¾-16	-08	64,5	3.54	55,9	2.20	9,7	.38	11,9	.47	7/8	13/16
FJ9775-1212S	FJ8775-1212S	FC1410-12S	1½-12	-12	107,7	4.24	64,0	2.52	15,5	.61	13,2	.52	1¼	
FJ9775-1616S	FJ8775-1616S	FC1410-16S	1½-12	-16	130,3	5.13	82,3	3.24	19,8	.78	17,5	.69	1½	
FJ9775-2020S	*	*	1½-12	-20	163,1	6.42	95,8	3.77	26,7	1.05	20,3	.80	2	
FJ9775-2424S	*	*	1¾-12	-24	188,2	7.41	114,0	4.49	32,0	1.26	24,1	.95	2¼	
30° Elbow														
FC5965-0808S	FC4965-0808S	FC3471-08S	¾-16	-08	88,6	3.49	54,4	2.14	9,7	.38	15,7	.62	7/8	13/16
FJ9776-1212S	FJ8776-1212S	FC1410-12S	1½-12	-12	106,2	4.18	62,2	2.45	15,5	.61	17,5	.69	1¼	
FJ9776-1616S	FJ8776-1616S	FC1410-16S	1½-12	-16	132,1	5.20	83,8	3.30	19,8	.78	24,1	.95	1½	
FJ9776-2020S	*	*	1½-12	-20	166,4	6.55	99,1	3.90	26,7	1.05	28,2	1.11	2	
FJ9776-2424S	*	*	1¾-12	-24	190,0	7.48	115,8	4.56	32,0	1.26	32,8	1.29	2¼	
45° Elbow														
FC9627-0808S	FC8627-0808S	FC3471-08S	¾-16	-08	87,9	3.46	53,8	2.12	9,7	.38	24,1	.95	7/8	13/16
FC9627-1210S	FC8627-1210S	FC3471-10S	1½-12	-10	103,4	4.07	66,0	2.60	12,7	.50	29,5	1.16	1¼	1
FJ9777-1212S	FJ8777-1212S	FC1410-12S	1½-12	-12	111,5	4.39	67,8	2.67	15,5	.61	29,5	1.16	1¼	
FJ9777-1616S	FJ8777-1616S	FC1410-16S	1½-12	-16	135,6	5.34	87,4	3.44	19,8	.78	38,9	1.53	1½	
FJ9777-2020S	*	*	1½-12	-20	165,4	6.51	98,0	3.86	26,7	1.05	43,2	1.70	2	
FJ9777-2424S	*	*	1¾-12	-24	189,7	7.47	115,6	4.55	32,0	1.26	50,5	1.99	2¼	
60° Elbow														
FC5967-0808S	FC4967-0808S	FC3471-08S	¾-16	-08	85,1	3.35	51,1	2.01	9,7	.38	32,0	1.26	7/8	13/16
FJ9778-1212S	FJ8778-1212S	FC1410-12S	1½-12	-12	111,0	4.37	67,3	2.65	15,5	.61	40,6	1.60	1¼	
FJ9778-1616S	FJ8778-1616S	FC1410-16S	1½-12	-16	133,1	5.24	84,8	3.34	19,8	.78	52,8	2.08	1½	
FJ9778-2020S	*	*	1½-12	-20	164,1	6.46	96,8	3.81	26,7	1.05	59,2	2.33	2	
FJ9778-2424S	*	*	1¾-12	-24	186,9	7.36	112,8	4.44	32,0	1.26	69,1	2.72	2¼	
67½° Elbow														
FC5969-0808S	FC4969-0808S	FC3471-08S	¾-16	-08	85,6	3.37	51,6	2.03	9,7	.38	37,3	1.47	7/8	13/16
FJ9779-1212S	FJ8779-1212S	FC1410-12S	1½-12	-12	109,2	4.30	65,5	2.58	15,5	.61	45,7	1.80	1¼	
FJ9779-1616S	FJ8779-1616S	FC1410-16S	1½-12	-16	131,6	5.18	83,3	3.28	19,8	.78	59,9	2.36	1½	
FJ9779-2020S	*	*	1½-12	-20	160,8	6.33	93,5	3.68	26,7	1.05	66,5	2.62	2	
FJ9779-2424S	*	*	1¾-12	-24	172,5	6.79	98,3	3.87	32,0	1.26	70,1	2.76	2¼	
90° Elbow														
FC9625-0808S	FC8625-0808S	FC3471-08S	¾-16	-08	77,2	3.04	42,9	1.69	9,7	.38	47,5	1.87	7/8	13/16
FC9625-1210S	FC8625-1210S	FC3471-10S	1½-12	-10	92,2	3.63	54,9	2.16	12,7	.50	59,7	2.35	1¼	1
FJ9780-1212S	FJ8780-1212S	FC1410-12S	1½-12	-12	100,3	3.95	56,6	2.23	15,5	.61	59,7	2.35	1¼	
FJ9780-1616S	FJ8780-1616S	FC1410-16S	1½-12	-16	118,9	4.68	70,6	2.78	19,8	.78	77,2	3.04	1½	
FJ9780-2020S	*	*	1½-12	-20	147,8	5.82	80,5	3.17	26,7	1.05	86,4	3.40	2	
FJ9780-2424S	*	*	1¾-12	-24	167,9	6.61	93,7	3.69	32,0	1.26	100,3	3.95	2¼	

*Complete fittings are one-piece assemblies.

SPECIALTY & TRUCK HOSE
 LOW & MEDIUM PRESSURE HOSE
 HIGH PRESSURE HOSE
 HOSE FITTINGS
 ADAPTERS & TUBE FITTINGS
 ACCESSORIES & ASSEMBLY INSTRUCTIONS
 HOSE ASSEMBLY EQUIPMENT
 APPENDICES

Spiral Single Skive Crimp Fittings

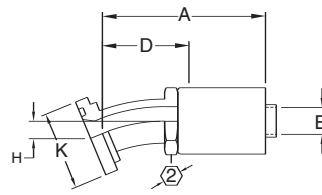
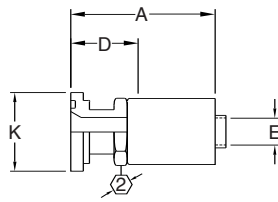

For use with hose: FC736 (-06 thru -20), FC136, FC254 (-20, -24), FC323 (-12, -16, -20, -24), FC324 (-12, -16), GH493

Straight Split Flange
FJ9569/FC9725/FJ9761 Code 61
FC9853/FJ9762 Code 62

22 1/2° Elbow Split Flange
FJ9571/FC9929/FJ9763 Code 61
FC5957/FJ9764 Code 62

Complete Fitting Part #	Component Part Numbers		Flange Head Dia. K Ø	Hose Size	A		D		EØ		H	
	Nipple Assy. Part #	Socket Part #			mm	in	mm	in	mm	in		
Straight split flange – Code 61 (SAE J518)												
FC9725-0808S	FC8725-0808S	FC3471-08S	30,2	1.19	-08	90,4	3.56	56,1	2.21	9,7	.38	
FC9725-1208S	FC8725-1208S	FC3471-08S	38,1	1.50	-08	90,4	3.56	56,1	2.21	9,7	.38	13/16
FC9725-1210S	FC8725-1210S	FC3471-10S	38,1	1.50	-10	101,3	3.99	64,0	2.52	12,7	.50	1
FJ9761-1212S	FJ8761-1212S	FC1410-12S	38,1	1.50	-12	109,5	4.31	65,8	2.59	15,5	.61	
FJ9761-1612S	FJ8761-1612S	FC1410-12S	44,5	1.75	-12	109,5	4.31	65,8	2.59	15,5	.61	
FJ9761-1616S	FJ8761-1616S	FC1410-16S	44,5	1.75	-16	127,8	5.03	79,8	3.14	19,8	.78	
FJ9761-2016S	FJ8761-2016S	FC1410-16S	50,8	2.00	-16	127,8	5.03	79,8	3.14	19,8	.78	
FJ9761-2020S	*	*	50,8	2.00	-20	151,1	5.95	83,8	3.30	26,7	1.05	
FJ9761-2420S	*	*	60,5	2.38	-20	151,1	5.95	83,8	3.30	26,7	1.05	
FJ9761-2424S	*	*	60,5	2.38	-24	176,5	6.95	102,1	4.02	32,0	1.26	
FJ9761-3224S	*	*	71,4	2.81	-24	176,5	6.95	102,1	4.02	32,0	1.26	
FJ9569-3232S	*	*	71,4	2.81	-32	207,8	8.18	122,4	4.82	42,9	1.69	
Straight split flange – Code 62 (SAE J518)												
FC9853-1208S	FC8853-1208S	FC3471-08S	41,1	1.62	-08	90,4	3.56	56,1	2.21	9,7	.38	13/16
FJ9762-1212S	FJ8762-1212S	FC1410-12S	41,1	1.62	-12	109,5	4.31	65,8	2.59	15,5	.61	
FJ9762-1612S	FJ8762-1612S	FC1410-12S	47,8	1.88	-12	109,5	4.31	65,8	2.59	15,5	.61	
FJ9762-1616S	FJ8762-1616S	FC1410-16S	47,8	1.88	-16	127,8	5.03	79,8	3.14	19,8	.78	
FJ9762-2016S	FJ8762-2016S	FC1410-16S	53,8	2.12	-16	127,8	5.03	79,8	3.14	19,8	.78	
FJ9762-2020S	*	*	53,8	2.12	-20	151,1	5.95	83,8	3.30	26,7	1.05	
FJ9762-2420S	*	*	63,5	2.50	-20	151,1	5.95	83,8	3.30	26,7	1.05	
FJ9762-2424S	*	*	63,5	2.50	-24	176,5	6.95	102,1	4.02	32,0	1.26	
FJ9762-3224S	*	*	79,2	3.12	-24	170,4	6.71	102,1	4.02	32,0	1.26	
22 1/2° Elbow split flange – Code 61 (SAE J518)												
FC9929-0808S	FC8929-0808S	FC3471-08S	30,2	1.19	-08	84,3	3.32	50,0	1.97	9,7	.38	8,1 .32
FC9929-1208S	FC8929-1208S	FC3471-08S	38,1	1.50	-08	84,3	3.32	50,0	1.97	9,7	.38	9,7 .38
FJ9763-1212S	FJ8763-1212S	FC1410-12S	38,1	1.50	-12	102,6	4.04	58,7	2.31	15,5	.61	11,2 .44
FJ9763-1612S	FJ8763-1612S	FC1410-12S	44,5	1.75	-12	102,6	4.04	58,7	2.31	15,5	.61	11,2 .44
FJ9763-1616S	FJ8763-1616S	FC1410-16S	44,5	1.75	-16	114,8	4.52	66,5	2.62	19,8	.78	11,2 .44
FJ9763-2016S	FJ8763-2016S	FC1410-16S	50,8	2.00	-16	114,8	4.52	66,5	2.62	19,8	.78	11,2 .44
FJ9763-2020S	*	*	50,8	2.00	-20	145,0	5.71	77,7	3.06	26,7	1.05	12,7 .50
FJ9763-2420S	*	*	60,5	2.38	-20	145,0	5.71	77,7	3.06	26,7	1.05	12,7 .50
FJ9763-2424S	*	*	60,5	2.38	-24	168,9	6.65	94,7	3.73	32,0	1.26	16,0 .63
FJ9763-3224S	*	*	71,4	2.81	-24	168,9	6.65	94,7	3.73	32,0	1.26	16,0 .63
FJ9571-3232S	*	*	71,4	2.81	-32	207,8	8.18	122,4	4.82	42,9	1.69	22,4 .88
22 1/2° Elbow split flange – Code 62 (SAE J518)												
FC5957-1208S	FC4957-1208S	FC3471-08S	41,1	1.62	-08	84,3	3.32	50,0	1.97	9,7	.38	9,7 .38
FJ9764-1212S	FJ8764-1212S	FC1410-12S	41,1	1.62	-12	102,6	4.04	58,7	2.31	15,5	.61	11,2 .44
FJ9764-1612S	FJ8764-1612S	FC1410-12S	47,8	1.88	-12	102,6	4.04	58,7	2.31	15,5	.61	11,2 .44
FJ9764-1616S	FJ8764-1616S	FC1410-16S	47,8	1.88	-16	114,8	4.52	66,5	2.62	19,8	.78	11,2 .44
FJ9764-2016S	FJ8764-2016S	FC1410-16S	53,8	2.12	-16	114,8	4.52	66,5	2.62	19,8	.78	11,2 .44
FJ9764-2020S	*	*	53,8	2.12	-20	145,0	5.71	77,7	3.06	26,7	1.05	12,7 .50
FJ9764-2420S	*	*	63,5	2.50	-20	145,0	5.71	77,7	3.06	26,7	1.05	12,7 .50
FJ9764-2424S	*	*	63,5	2.50	-24	168,9	6.65	94,7	3.73	32,0	1.26	16,0 .63
FJ9764-3224S	*	*	79,2	3.12	-24	168,9	6.65	94,7	3.73	32,0	1.26	16,0 .63

*Complete fittings are one-piece assemblies.

NOTE: For flanges, split flange halves, kits and o-rings, see pages 190-195.

Spiral Single Skive Crimp Fittings

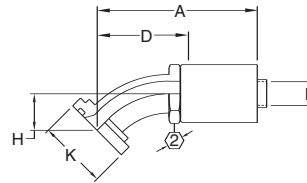
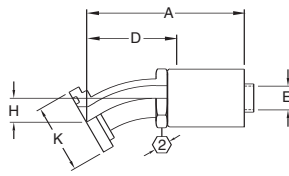

For use with hose: FC736 (-06 thru -20), FC136, FC254 (-20, -24), FC323 (-12, -16, -20, -24), FC324 (-12, -16), GH493

30° Elbow Split Flange
FJ9573/FJ9765 Code 61
FC9854/FJ9766 Code 62

45° Elbow Split Flange
FJ9575/FC9724/FJ9787 Code 61
FC9855/FJ9767 Code 62

Complete Fitting Part #	Component Part Numbers		Flange Head Dia. K Ø	Hose Size	A		D		EØ		H		
	Nipple Assy. Part #	Socket Part #			mm	in	mm	in	mm	in	mm	in	

30° Elbow split flange – Code 61 (SAE J518)

FJ9765-1212S	FJ8765-1212S	FC1410-12S	38,1	1.50	-12	101,1	3.98	57,4	2.26	15,5	.61	14,7	.58	
FJ9765-1612S	FJ8765-1612S	FC1410-12S	44,5	1.75	-12	101,1	3.98	57,4	2.26	15,5	.61	14,7	.58	
FJ9765-1616S	FJ8765-1616S	FC1410-16S	44,5	1.75	-16	117,3	4.62	69,1	2.72	19,8	.78	15,5	.61	
FJ9765-2016S	FJ8765-2016S	FC1410-16S	50,8	2.00	-16	117,3	4.62	69,1	2.72	19,8	.78	15,5	.61	
FJ9765-2020S	*	*	50,8	2.00	-20	149,4	5.88	82,0	3.23	26,7	1.05	18,3	.72	
FJ9765-2420S	*	*	60,5	2.38	-20	149,4	5.88	82,0	3.23	26,7	1.05	18,3	.72	
FJ9765-2424S	*	*	60,5	2.38	-24	172,0	6.77	97,8	3.85	32,0	1.26	22,4	.88	
FJ9765-3224S	*	*	71,4	2.81	-24	172,0	6.77	97,8	3.85	32,0	1.26	22,4	.88	
FJ9573-3232S	*	*	71,4	2.81	-32	213,9	8.42	128,5	5.06	42,9	1.69	31,8	1.25	

30° Elbow split flange – Code 62 (SAE J518)

FC9854-1208S	FC8854-1208S	FC3471-08S	41,1	1.62	-08	83,3	3.28	49,0	1.93	9,7	.38	12,7	.50	13/16
FJ9766-1212S	FJ8766-1212S	FC1410-12S	41,1	1.62	-12	101,1	3.98	57,4	2.26	15,5	.61	14,7	.58	
FJ9766-1612S	FJ8766-1612S	FC1410-12S	47,8	1.88	-12	101,1	3.98	57,4	2.26	15,5	.61	14,7	.58	
FJ9766-1616S	FJ8766-1616S	FC1410-16S	47,8	1.88	-16	117,3	4.62	69,1	2.72	19,8	.78	15,5	.62	
FJ9766-2016S	FJ8766-2016S	FC1410-16S	53,8	2.12	-16	117,3	4.62	69,1	2.72	19,8	.78	15,5	.62	
FJ9766-2020S	*	*	53,8	2.12	-20	149,4	5.88	82,0	3.23	26,7	1.05	18,3	.72	
FJ9766-2420S	*	*	63,5	2.50	-20	149,4	5.88	82,0	3.23	26,7	1.05	18,3	.72	
FJ9766-2424S	*	*	63,5	2.50	-24	172,0	6.77	97,8	3.85	32,0	1.26	22,4	.88	
FJ9766-3224S	*	*	79,2	3.12	-24	172,0	6.77	97,8	3.85	32,0	1.26	22,4	.88	

45° Elbow split flange – Code 61 (SAE J518)

FC9724-0808S	FC8724-0808S	FC3471-08S	30,2	1.19	-08	83,6	3.29	49,5	1.95	9,7	.38	19,8	.78	13/16
FC9724-1208S	FC8724-1208S	FC3471-08S	38,1	1.50	-08	83,6	3.29	49,5	1.95	9,7	.38	19,8	.78	13/16
FC9724-1210S	FC8724-1210S	FC3471-10S	38,1	1.50	-10	99,3	3.91	62,2	2.45	12,7	.50	25,4	1.00	1
FJ9767-1212S	FJ8767-1212S	FC1410-12S	38,1	1.50	-12	107,7	4.24	63,8	2.51	15,5	.61	25,4	1.00	
FJ9767-1612S	FJ8767-1612S	FC1410-12S	44,5	1.75	-12	107,7	4.24	63,8	2.51	15,5	.61	25,4	1.00	
FJ9767-1616S	FJ8767-1616S	FC1410-16S	44,5	1.75	-16	123,7	4.87	75,4	2.97	19,8	.78	26,9	1.06	
FJ9767-2016S	FJ8767-2016S	FC1410-16S	50,8	2.00	-16	123,7	4.87	75,4	2.97	19,8	.78	26,9	1.06	
FJ9767-2020S	*	*	50,8	2.00	-20	151,6	5.97	84,3	3.32	26,7	1.05	29,2	1.15	
FJ9767-2420S	*	*	60,5	2.38	-20	151,6	5.97	84,3	3.32	26,7	1.05	29,2	1.15	
FJ9767-2424S	*	*	60,5	2.38	-24	174,8	6.88	100,6	3.96	32,0	1.26	35,8	1.41	
FJ9767-3224S	*	*	71,4	2.81	-24	174,8	6.88	100,6	3.96	32,0	1.26	35,8	1.41	
FJ9575-3232S	*	*	71,4	2.81	-32	217,9	8.58	132,8	5.23	42,9	1.69	50,8	2.00	

45° Elbow split flange – Code 62 (SAE J518)

FC9855-1208S	FC8855-1208S	FC3471-08S	41,1	1.62	-08	83,6	3.29	49,5	1.95	9,7	.38	19,8	.78	13/16
FJ9768-1212S	FJ8768-1212S	FC1410-12S	41,1	1.62	-12	107,7	4.24	63,8	2.51	15,5	.61	25,4	1.00	
FJ9768-1612S	FJ8768-1612S	FC1410-12S	47,8	1.88	-12	107,7	4.24	63,8	2.51	15,5	.61	25,4	1.00	
FJ9768-1616S	FJ8768-1616S	FC1410-16S	47,8	1.88	-16	123,7	4.87	75,4	2.97	19,8	.78	26,9	1.06	
FJ9768-2016S	FJ8768-2016S	FC1410-16S	53,8	2.12	-16	123,7	4.87	75,4	2.97	19,8	.78	26,9	1.06	
FJ9768-2020S	*	*	53,8	2.12	-20	151,6	5.97	84,3	3.32	26,7	1.05	29,2	1.15	
FJ9768-2420S	*	*	63,5	2.50	-20	151,6	5.97	84,3	3.32	26,7	1.05	29,2	1.15	
FJ9768-2424S	*	*	63,5	2.50	-24	174,8	6.88	100,6	3.96	32,0	1.26	35,8	1.41	
FJ9768-3224S	*	*	79,2	3.12	-24	174,8	6.88	100,6	3.96	32,0	1.26	35,8	1.41	

*Complete fittings are one-piece assemblies.
NOTE: For flanges, split flange halves, kits and o-rings, see pages 190-195.

SPECIALTY & TRUCK HOSE

LOW & MEDIUM PRESSURE HOSE

HIGH PRESSURE HOSE

HOSE FITTINGS

ADAPTERS & TUBE FITTINGS

ACCESSORIES & ASSEMBLY INSTRUCTIONS

HOSE ASSEMBLY EQUIPMENT

APPENDICES

Spiral Single Skive Crimp Fittings

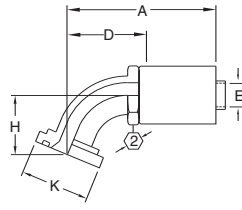
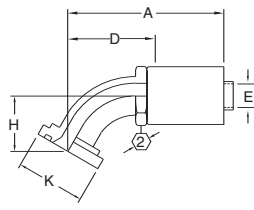

Spiral Single Skive Crimp Fittings for use with hose:
 FC736 (-06 thru -20), FC136, FC254 (-20, -24), FC323 (-12, -16, -20, -24), FC324 (-12, -16), GH493

60° Elbow Split Flange
 FC9802/FJ9769 Code 61
 FC7330/FJ9770 Code 62

67 1/2° Elbow Split Flange
 FJ9579/FC9726/FJ9771 Code 61
 FC5960/FJ9772 Code 62

Complete Fitting Part #	Component Part Numbers		Flange Head Dia. K Ø	Hose Size	A		D		EØ		H		②	
	Nipple Assy. Part #	Socket Part #			mm	in	mm	in	mm	in	mm	in		
60° Elbow split flange – Code 61 (SAEJ518)														
FC9802-0808S	FC8802-0808S	FC3471-08S	30,2	1.19	-08	82,0	3.23	47,8	1.88	9,7	.38	26,7	1.05	13/16
FC9802-1208S	FC8802-1208S	FC3471-08S	38,1	1.50	-08	82,0	3.23	47,8	1.88	9,7	.38	26,7	1.05	13/16
FJ9769-1212S	FJ8769-1212S	FC1410-12S	38,1	1.50	-12	108,2	4.26	64,5	2.54	15,5	.61	35,8	1.41	
FJ9769-1612S	FJ8769-1612S	FC1410-12S	44,5	1.75	-12	108,2	4.26	64,5	2.54	15,5	.61	35,8	1.41	
FJ9769-1616S	FJ8769-1616S	FC1410-16S	44,5	1.75	-16	124,5	4.90	76,5	3.01	19,8	.78	38,1	1.50	
FJ9769-2016S	FJ8769-2016S	FC1410-16S	50,8	2.00	-16	124,5	4.90	76,5	3.01	19,8	.78	38,1	1.50	
FJ9769-2020S	*	*	50,8	2.00	-20	154,2	6.07	86,9	3.42	26,7	1.05	42,2	1.66	
FJ9769-2420S	*	*	60,5	2.38	-20	154,2	6.07	86,9	3.42	26,7	1.05	42,2	1.66	
FJ9769-2424S	*	*	60,5	2.38	-24	176,3	6.94	102,1	4.02	32,0	1.26	50,8	2.00	
FJ9769-3224S	*	*	71,4	2.81	-24	176,3	6.94	102,1	4.02	32,0	1.26	50,8	2.00	
60° Elbow split flange – Code 62 (SAEJ518)														
FC7330-1208S	FC6330-1208S	FC3471-08S	41,1	1.62	-08	82,0	3.23	47,8	1.88	9,7	.38	26,7	1.05	13/16
FJ9770-1212S	FJ8770-1212S	FC1410-12S	41,1	1.62	-12	108,2	4.26	64,5	2.54	15,5	.61	35,8	1.41	
FJ9770-1612S	FJ8770-1612S	FC1410-12S	47,8	1.88	-12	108,2	4.26	64,5	2.54	15,5	.61	35,8	1.41	
FJ9770-1616S	FJ8770-1616S	FC1410-16S	47,8	1.88	-16	124,5	4.90	76,5	3.01	19,8	.78	38,1	1.50	
FJ9770-2016S	FJ8770-2016S	FC1410-16S	53,8	2.12	-16	124,5	4.90	76,5	3.01	19,8	.78	38,1	1.50	
FJ9770-2020S	*	*	53,8	2.12	-20	154,2	6.07	86,9	3.42	26,7	1.05	42,2	1.66	
FJ9770-2420S	*	*	63,5	2.50	-20	154,2	6.07	86,9	3.42	26,7	1.05	42,2	1.66	
FJ9770-2424S	*	*	63,5	2.50	-24	176,3	6.94	102,1	4.02	32,0	1.26	50,8	2.00	
FJ9770-3224S	*	*	79,2	3.12	-24	176,3	6.94	102,1	4.02	32,0	1.26	50,8	2.00	
67 1/2° Elbow split flange – Code 61 (SAEJ518)														
FC9726-0808S	FC8726-0808S	FC3471-08S	30,2	1.19	-08	83,3	3.28	49,3	1.94	9,7	.38	31,8	1.25	13/16
FC9726-1208S	FC8726-1208S	FC3471-08S	38,1	1.50	-08	83,3	3.28	49,3	1.94	9,7	.38	33,3	1.31	13/16
FJ9771-1212S	FJ8771-1212S	FC1410-12S	38,1	1.50	-12	107,2	4.22	63,2	2.49	15,5	.61	40,6	1.60	
FJ9771-1612S	FJ8771-1612S	FC1410-12S	44,5	1.75	-12	107,2	4.22	63,2	2.49	15,5	.61	40,6	1.60	
FJ9771-1616S	FJ8771-1616S	FC1410-16S	44,5	1.75	-16	125,0	4.92	77,0	3.03	19,8	.78	44,5	1.75	
FJ9771-2016S	FJ8771-2016S	FC1410-16S	50,8	2.00	-16	125,0	4.92	77,0	3.03	19,8	.78	44,5	1.75	
FJ9771-2020S	*	*	50,8	2.00	-20	153,4	6.04	84,1	3.39	26,7	1.05	48,3	1.90	
FJ9771-2420S	*	*	60,5	2.38	-20	153,4	6.04	84,1	3.39	26,7	1.05	48,3	1.90	
FJ9771-2424S	*	*	60,5	2.38	-24	164,6	6.48	90,4	3.56	32,0	1.26	50,8	2.00	
FJ9771-3224S	*	*	71,4	2.81	-24	164,6	6.48	90,4	3.56	32,0	1.26	50,8	2.00	
FJ9579-3232S	*	*	71,4	2.81	-32	218,9	8.62	133,9	5.27	42,9	1.69	82,6	3.25	
67 1/2° Elbow split flange – Code 62 (SAEJ518)														
FC5960-1208S	FC4960-1208S	FC3471-08S	41,1	1.62	-08	83,3	3.28	49,3	1.94	9,7	.38	31,8	1.25	13/16
FJ9772-1212S	FJ8772-1212S	FC1410-12S	41,1	1.62	-12	107,2	4.22	63,2	2.49	15,5	.61	40,6	1.60	
FJ9772-1612S	FJ8772-1612S	FC1410-12S	47,8	1.88	-12	107,2	4.22	63,2	2.49	15,5	.61	40,6	1.60	
FJ9772-1616S	FJ8772-1616S	FC1410-16S	47,8	1.88	-16	125,0	4.92	77,0	3.03	19,8	.78	44,5	1.75	
FJ9772-2016S	FJ8772-2016S	FC1410-16S	53,8	2.12	-16	125,0	4.92	77,0	3.03	19,8	.78	44,5	1.75	
FJ9772-2020S	*	*	53,8	2.12	-20	153,4	6.04	84,1	3.39	26,7	1.05	48,3	1.90	
FJ9772-2420S	*	*	63,5	2.50	-20	153,4	6.04	84,1	3.39	26,7	1.05	48,3	1.90	
FJ9772-2424S	*	*	63,5	2.50	-24	164,6	6.48	90,4	3.56	32,0	1.26	50,8	2.00	
FJ9772-3224S	*	*	79,2	3.12	-24	164,6	6.48	90,4	3.56	32,0	1.26	50,8	2.00	

*Complete fittings are one-piece assemblies.

NOTE: For flanges, split flange halves, kits and o-rings, see pages 190-195.

Spiral Single Skive Crimp Fittings

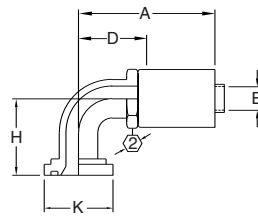

For use with hose: FC736 (-06 thru -20), FC136, FC254 (-20, -24), FC323 (-12, -16, -20, -24), FC324 (-12, -16), GH493

90° Elbow Split Flange
 FJ9581/FC9727/FJ9773 Code 61
 FC9856/FJ9774 Code 62

SPECIALTY & TRUCK HOSE

LOW & MEDIUM PRESSURE HOSE

HIGH PRESSURE HOSE

HOSE FITTINGS

ADAPTERS & TUBE FITTINGS

ACCESSORIES & ASSEMBLY INSTRUCTIONS

HOSE ASSEMBLY EQUIPMENT

APPENDICES

Complete Fitting Part #	Component Part Numbers		Flange Head Dia. K Ø	Hose Size	A		D		EØ		H		②	
	Nipple Assy. Part #	Socket Part #			mm	in	mm	in	mm	in	mm	in		
90° Elbow split flange – Code 61 (SAEJ518)														
FC9727-0808S	FC8727-0808S	FC3471-08S	30,2	1.19	-08	77,2	3.04	42,9	1.69	9,7	.38	41,1	1.62	13/16
FC9727-1208S	FC8727-1208S	FC3471-08S	38,1	1.50	-08	77,2	3.04	42,9	1.69	9,7	.38	41,1	1.62	13/16
FC9727-1210S	FC8727-1210S	FC3471-10S	38,1	1.50	-10	92,2	3.63	54,9	2.16	12,7	.50	54,1	2.13	1
FJ9773-1212S	FJ8773-1212S	FC1410-12S	38,1	1.50	-12	100,3	3.95	56,6	2.23	15,5	.61	54,1	2.13	
FJ9773-1612S	FJ8773-1612S	FC1410-12S	44,5	1.75	-12	100,3	3.95	56,6	2.23	15,5	.61	54,1	2.13	
FJ9773-1616S	FJ8773-1616S	FC1410-16S	44,5	1.75	-16	118,9	4.68	70,6	2.78	19,8	.78	60,5	2.38	
FJ9773-2016S	FJ8773-2016S	FC1410-16S	50,8	2.00	-16	118,9	4.68	70,6	2.78	19,8	.78	60,5	2.38	
FJ9773-2020S	*	*	50,8	2.00	-20	147,6	5.81	80,5	3.17	26,7	1.05	66,5	2.62	
FJ9773-2420S	*	*	60,5	2.38	-20	147,6	5.81	80,5	3.17	26,7	1.05	66,5	2.62	
FJ9773-2424S	*	*	60,5	2.38	-24	167,9	6.61	93,7	3.69	32,0	1.26	79,2	3.12	
FJ9773-3224S	*	*	71,4	2.81	-24	167,9	6.61	98,0	3.86	32,0	1.26	79,2	3.12	
FJ9581-3232S	*	*	71,4	2.81	-32	209,8	8.26	124,5	4.90	42,9	1.69	114,3	4.50	
90° Elbow split flange – Code 62 (SAEJ518)														
FC9856-0808S	FC8856-0808S	FC3471-08S	31,8	1.25	-08	77,2	3.04	42,9	1.69	9,7	.38	41,1	1.62	13/16
FC9856-1208S	FC8856-1208S	FC3471-08S	41,1	1.62	-08	77,2	3.04	42,9	1.69	9,7	.38	41,1	1.62	13/16
FJ9774-1212S	FJ8774-1212S	FC1410-12S	41,1	1.62	-12	100,3	3.95	56,6	2.23	15,5	.61	54,1	2.13	
FJ9774-1612S	FJ8774-1612S	FC1410-12S	47,8	1.88	-12	100,3	3.95	56,6	2.23	15,5	.61	54,1	2.13	
FJ9774-1616S	FJ8774-1616S	FC1410-16S	47,8	1.88	-16	118,9	4.68	70,6	2.78	19,8	.78	60,5	2.38	
FJ9774-2016S	FJ8774-2016S	FC1410-16S	53,8	2.12	-16	118,9	4.68	70,6	2.78	19,8	.78	60,5	2.38	
FJ9774-2020S	*	*	53,8	2.12	-20	147,6	5.81	80,5	3.17	26,7	1.05	66,5	2.62	
FJ9774-2420S	*	*	63,5	2.50	-20	147,6	5.81	80,5	3.17	26,7	1.05	66,5	2.62	
FJ9774-2424S	*	*	63,5	2.50	-24	167,9	6.61	93,7	3.69	32,0	1.26	79,2	3.12	
FJ9774-3224S	*	*	79,2	3.12	-24	167,9	6.61	93,7	3.69	32,0	1.26	79,2	3.12	

*Complete fittings are one-piece assemblies.

NOTE: For flanges, split flange halves, kits and o-rings, see pages 190-195.

Spiral Single Skive Crimp Fittings

For use with hose: FC136, FC736 (-06 thru -20), FC254 (-20, -24), FC323 (-12, -16, -20, -24), FC324 (-12, -16), GH493

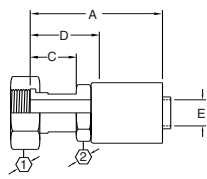

ORS Swivel Straight
FJ9606/FJ9896

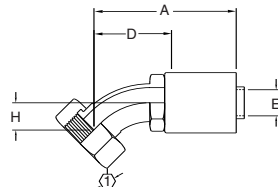

ORS Swivel 45° elbow
FJ9609/FJ9897

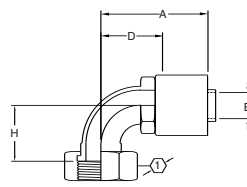

ORS Swivel 90° elbow (short)
FJ9612/FJ9898

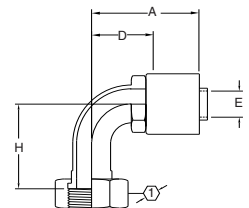

ORS Swivel 90° elbow (long)
FJ9715/FJ9899

Complete Fitting Part #	Component Part Numbers		Thd.	Hose Size	A		C		D		EØ		H	1	2
	Nipple Assy. Part #	Socket Part #			mm	in	mm	in	mm	in	mm	in			
Straight															
FJ9606-0606S	FJ8307-0606S	FC3471-06S	1 ¹ / ₁₆ -16	-06	61,0	2.40	18,3	.72	30,5	1.20	6,6	.26		1 ³ / ₁₆	1 ¹ / ₁₆
FJ9606-0808S	FJ8307-0808S	FC3471-08S	1 ³ / ₁₆ -16	-08	72,4	2.85	22,1	.87	38,1	1.50	9,7	.38		1 ⁵ / ₁₆	1 ³ / ₁₆
FJ9896-1212S	FJ8896-1212S	FC1410-12S	1 ³ / ₁₆ -12	-12	90,7	3.57	27,2	1.07	47,0	1.85	15,5	.61		1 ³ / ₈	1 ¹ / ₁₆
FJ9896-1612S	FJ8896-1612S	FC1410-12S	1 ⁷ / ₁₆ -12	-12	92,5	3.64	29,0	1.14	48,8	1.92	15,5	.61		1 ⁵ / ₈	1 ³ / ₈
FJ9896-1616S	FJ8896-1616S	FC1410-16S	1 ⁷ / ₁₆ -12	-16	103,1	4.06	29,0	1.14	54,9	2.16	19,8	.78		1 ⁵ / ₈	1 ³ / ₈
FJ9896-2020S	*	*	1 ¹¹ / ₁₆ -12	-20	125,5	4.94	28,7	1.13	58,4	2.30	26,7	1.05		1 ⁷ / ₈	1 ⁵ / ₈
FJ9896-2424S	*	*	2-12	-24	133,1	5.24	25,4	1.00	58,9	2.32	32,0	1.26		2 ¹ / ₄	2
45° Elbow															
FJ9609-0808S	FJ8609-0808S	FC3471-08S	1 ³ / ₁₆ -16	-08	77,2	3.04	43,2	1.70	9,7	.38	15,0	.59	23,9	.94	1 ³ / ₁₆
FJ9897-1212S	FJ8897-1212S	FC1410-12S	1 ³ / ₁₆ -12	-12	103,1	4.06	59,2	2.33	15,5	.61	21,1	.83	35,0	1.38	
FJ9897-1616S	FJ8897-1616S	FC1410-16S	1 ⁷ / ₁₆ -12	-16	123,7	4.87	75,7	2.98	19,8	.78	23,9	.94	41,1	1.62	
FJ9897-2020S	*	*	1 ¹¹ / ₁₆ -12	-20	144,0	5.67			76,7	3.02	25,7	1.01	25,4	1.00	1 ⁷ / ₈
FJ9897-2424S	*	*	2-12	-24	165,4	6.51			91,2	3.59	30,2	1.19	27,2	1.07	2 ¹ / ₄
90° Elbow (short)															
FJ9612-0808S	FJ8612-0808S	FC3471-08S	1 ³ / ₁₆ -16	-08	71,4	2.81			37,1	1.46	9,7	.38	29,2	1.15	1 ⁵ / ₁₆
FJ9898-1212S	FJ8898-1212S	FC1410-12S	1 ³ / ₁₆ -12	-12	100,3	3.95			56,6	2.23	15,5	.61	47,8	1.88	1 ³ / ₈
FJ9898-1612S	FJ8898-1612S	FC1410-12S	1 ⁷ / ₁₆ -12	-12	112,0	4.41			68,1	2.68	15,5	.61	56,1	2.21	1 ⁵ / ₈
FJ9898-1616S	FJ8898-1616S	FC1410-16S	1 ⁷ / ₁₆ -12	-16	116,3	4.58			68,1	2.68	19,8	.78	56,1	2.21	1 ⁵ / ₈
FJ9898-2020S	*	*	1 ¹¹ / ₁₆ -12	-20	146,1	5.75			77,5	3.10	25,7	1.01	63,8	2.51	1 ⁷ / ₈
FJ9898-2424S	*	*	2-12	-24	167,9	6.61			93,7	3.69	30,2	1.19	68,6	2.70	2 ¹ / ₄
90° Elbow (long)															
FJ9715-0808S	FJ8715-0808S	FC3471-08S	1 ³ / ₁₆ -16	-08	77,2	3.04			42,9	1.69	9,7	.38	63,8	2.51	1 ⁵ / ₁₆
FJ9899-1212S	FJ8899-1212S	FC1410-12S	1 ³ / ₁₆ -12	-12	100,3	3.95			56,6	2.23	15,5	.61	96,0	3.78	1 ³ / ₈
FJ9899-1616S	FJ8899-1616S	FC1410-16S	1 ⁷ / ₁₆ -12	-16	118,9	4.68			70,6	2.78	19,8	.78	114,3	4.50	1 ⁵ / ₈
FJ9899-2020S	*	*	1 ¹¹ / ₁₆ -12	-20	147,6	5.81			80,3	3.16	25,7	1.01	129,3	5.09	1 ⁷ / ₈
FJ9899-2424S	*	*	2-12	-24	167,9	6.61			93,5	3.68	30,2	1.19	140,7	5.54	2 ¹ / ₄

NOTE: see pages 194, 195 for o-rings.

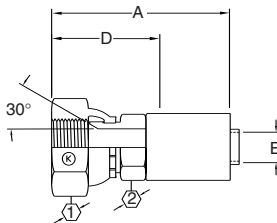

30° swivel —
Metric threads Special Komatsu
FJ7188

Complete Fitting Part #	Component Part Numbers		Thd.	Hose Size	A		D		EØ		1	2
	Nipple Assy. Part #	Socket Part #			mm	in	mm	in	mm	in		
30° Swivel—Metric threads												
FJ7188-0612S	FJ6188-0612S	FC1410-12S	M30x1.5	-12	97,5	3.84	53,8	2.12	15,5	.61		1 ¹ / ₂
FJ7188-1016S	FJ6188-1016S	FC1410-16S	M33x1.5	-16	107,7	4.24	59,4	2.34	19,8	.78		1 ⁵ / ₈
FJ7188-1220S	*	*	M36x1.5	-20	135,1	5.32	67,8	2.67	24,1	.95		1 ¹³ / ₁₆
FJ7188-1424S	*	*	M42x1.5	-24	147,8	5.82	73,4	2.89	30,2	1.19		2 ¹ / ₄

*Complete fittings are one-piece assemblies.

Spiral Single Skive Crimp Fittings

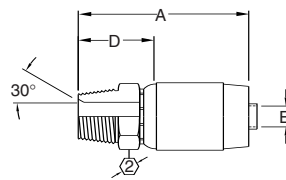

Male Pipe
FJ9781

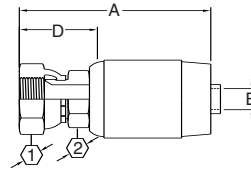

SAE 37° (JIC) Swivel
FJ9782

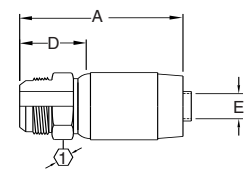

SAE 37° (JIC) Male Flare
FJ9917

For use with hose:
FC254, FC273

Complete Fitting Part #	Component Part Numbers		Thd.	Hose Size	A		D		EØ		①	②
	Nipple Assy. Part #	Socket Part #			mm	in	mm	in	mm	in		
Male pipe												
FJ9781-0812S	*	*	1/2-14	-12	99,6	3.92	40,9	1.61	15,5	.61		1 1/16
FJ9781-1212S	*	*	3/4-14	-12	101,1	3.98	42,4	1.67	15,5	.61		1 1/16
FJ9781-1612S	*	*	1-11 1/2	-12	107,7	4.24	49,0	1.93	15,5	.61		1 3/8
FJ9781-1216S	*	*	3/4-14	-16	108,2	4.26	43,2	1.70	19,8	.78		1 1/4
FJ9781-1616S	*	*	1-11 1/2	-16	113,5	4.47	48,3	1.90	19,8	.78		1 3/8
FJ9781-2016S	*	*	1 1/4-11 1/2	-16	117,1	4.61	51,8	2.04	19,8	.78		1 11/16
SAE 37° (JIC) swivel												
FJ9782-1212S	*	*	1 1/16-12	-12	100,1	3.94	47,2	1.86	15,5	.61	1 1/4	1 1/16
FJ9782-1612S	*	*	1 5/16-12	-12	111,0	4.37	52,3	2.06	15,5	.61	1 1/2	1 1/4
FJ9782-1616S	*	*	1 5/16-12	-16	114,5	4.51	53,1	2.09	19,8	.78	1 1/2	1 1/4
FJ9782-2016S	*	*	1 5/8-12	-16	123,7	4.87	58,4	2.30	19,8	.78	2	1 9/16
SAE 37° (JIC) male flare												
FJ9917-1212S	*	*	1 1/16-12	-12	103,9	4.09	45,2	1.78	15,5	.61		1 1/8
FJ9917-1612S	*	*	1 5/16-12	-12	106,9	4.21	48,3	1.90	15,5	.61		1 3/8
FJ9917-1616S	*	*	1 5/16-12	-16	114,0	4.49	49,0	1.93	19,8	.78		1 3/8
FJ9917-2016S	*	*	1 5/8-12	-16	116,8	4.60	51,6	2.03	19,8	.78		1 11/16

*Complete fittings are one-piece assemblies.

SPECIALTY & TRUCK HOSE

LOW & MEDIUM PRESSURE HOSE

HIGH PRESSURE HOSE

HOSE FITTINGS

ADAPTERS & TUBE FITTINGS

ACCESSORIES & ASSEMBLY INSTRUCTIONS

HOSE ASSEMBLY EQUIPMENT

APPENDICES

Spiral Single Skive Crimp Fittings

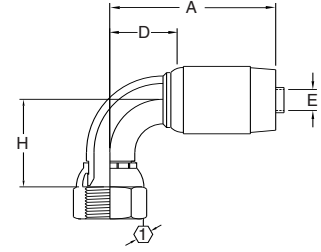
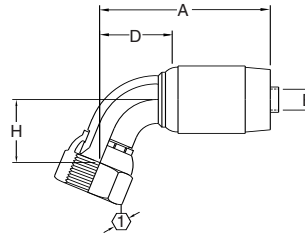
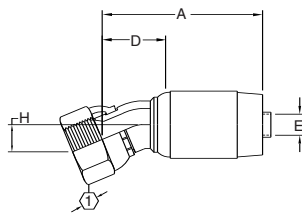

For use with Hose:
FC254, FC273

SAE 37°
(JIC) swivel
FJ9797 22 1/2° Elbow
FJ9798 30° Elbow
FJ9799 45° Elbow

SAE 37°
(JIC) swivel
FJ9800 60° Elbow
FJ9801 67 1/2° Elbow

SAE 37°
(JIC) swivel
FJ9802 90° Elbow

Complete Fitting Part #	Component Part Numbers		Thd.	Hose Size	A		D		EØ		H		1
	Nipple Assy. Part #	Socket Part #			mm	in	mm	in	mm	in	mm	in	
22 1/2° Elbow													
FJ9797-1212S	*	*	1 1/16-12	-12	122,9	4.84	64,3	2.53	15,5	.61	13,2	.52	1 1/4
FJ9797-1616S	*	*	1 5/16-12	-16	173,7	6.84	83,3	3.28	19,8	.78	17,5	.69	1 1/2
30° Elbow													
FJ9798-1212S	*	*	1 1/16-12	-12	121,4	4.78	62,7	2.47	15,5	.61	17,5	.69	1 1/4
FJ9798-1616S	*	*	1 5/16-12	-16	150,1	5.91	84,8	3.34	19,8	.78	24,1	.95	1 1/2
45° Elbow													
FJ9799-1212S	*	*	1 1/16-12	-12	126,7	4.99	68,1	2.68	15,5	.61	29,5	1.16	1 1/4
FJ9799-1616S	*	*	1 5/16-12	-16	153,7	6.05	88,4	3.48	19,8	.78	38,9	1.53	1 1/2
60° Elbow													
FJ9800-1212S	*	*	1 1/16-12	-12	126,5	4.98	67,8	2.67	15,5	.61	40,6	1.60	1 1/4
FJ9800-1616S	*	*	1 5/16-12	-16	151,1	5.95	85,9	3.38	19,8	.78	52,8	2.08	1 1/2
67 1/2° Elbow													
FJ9801-1212S	*	*	1 1/16-12	-12	124,5	4.90	65,8	2.59	15,5	.61	45,7	1.80	1 1/4
FJ9801-1616S	*	*	1 5/16-12	-16	149,6	5.89	84,3	3.32	19,8	.78	59,9	2.36	1 1/2
90° Elbow													
FJ9802-1212S	*	*	1 1/16-12	-12	115,6	4.55	56,9	2.24	15,5	.61	59,7	2.35	1 1/4
FJ9802-1616S	*	*	1 5/16-12	-16	136,9	5.39	71,6	2.82	19,8	.78	77,2	3.04	1 1/2

*Complete fittings are one-piece assemblies.

SPECIALTY & TRUCK HOSE

LOW & MEDIUM PRESSURE HOSE

HIGH PRESSURE HOSE

HOSE FITTINGS

ADAPTERS & TUBE FITTINGS

ACCESSORIES & ASSEMBLY INSTRUCTIONS

HOSE ASSEMBLY EQUIPMENT

APPENDICES

Spiral Single Skive Crimp Fittings

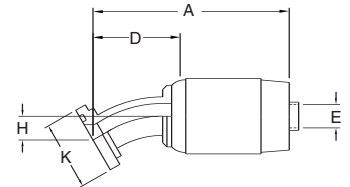
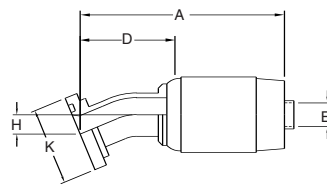
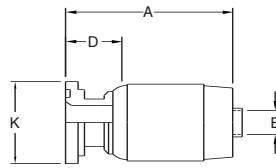

For use with Hose:
FC254, FC273

Straight Split Flange
FJ9783 Code 61
FJ9784 Code 62

22¹/₂° Elbow Split Flange
FJ9785 Code 61
FJ9786 Code 62

30° Elbow Split Flange
FJ9787 Code 61
FJ9788 Code 62

Complete Fitting Part #	Component Part Numbers		Flange Head Dia. K Ø		Hose Size	A		D		EØ		H	
	Nipple Assy. Part #	Socket Part #	mm	in		mm	in	mm	in	mm	in	mm	in
Straight Split Flange - Code 61(SAEJ518)													
FJ9783-1212S	*	*	38,1	1.50	-12	125,0	4.92	66,3	2.61	15,5	.61		
FJ9783-1612S	*	*	44,5	1.75	-12	125,0	4.92	66,3	2.61	15,5	.61		
FJ9783-1616S	*	*	44,5	1.75	-16	145,8	5.74	80,8	3.18	19,8	.78		
FJ9783-2016S	*	*	50,8	2.00	-16	145,8	5.74	80,8	3.18	19,8	.78		
Straight Split Flange - Code 62(SAEJ518)													
FJ9784-1212S	*	*	41,1	1.62	-12	125,0	4.92	66,3	2.61	15,5	.61		
FJ9784-1612S	*	*	47,8	1.88	-12	125,0	4.92	66,3	2.61	15,5	.61		
FJ9784-1616S	*	*	47,8	1.88	-16	145,8	5.74	80,8	3.18	19,8	.78		
FJ9784-2016S	*	*	53,8	2.12	-16	145,8	5.74	80,8	3.18	19,8	.78		
22¹/₂° Elbow Split Flange - Code 61(SAEJ518)													
FJ9785-1212S	*	*	38,1	1.50	-12	117,9	4.64	59,2	2.33	15,5	.61	11,2	.44
FJ9785-1612S	*	*	44,5	1.75	-12	117,9	4.64	59,2	2.33	15,5	.61	11,2	.44
FJ9785-1616S	*	*	44,5	1.75	-16	132,8	5.23	67,6	2.66	19,8	.78	11,2	.44
FJ9785-2016S	*	*	50,8	2.00	-16	132,8	5.23	67,6	2.66	19,8	.78	11,2	.44
22¹/₂° Elbow Split Flange - Code 62(SAEJ518)													
FJ9786-1212S	*	*	41,1	1.62	-12	117,9	4.64	59,2	2.33	15,5	.61	11,2	.44
FJ9786-1612S	*	*	47,8	1.88	-12	117,9	4.64	59,2	2.33	15,5	.61	11,2	.44
FJ9786-1616S	*	*	47,8	1.88	-16	132,8	5.23	67,6	2.66	19,8	.78	11,2	.44
FJ9786-2016S	*	*	53,8	2.12	-16	132,8	5.23	67,6	2.66	19,8	.78	11,2	.44
30° Elbow Split Flange - Code 61(SAEJ518)													
FJ9787-1212S	*	*	38,1	1.50	-12	116,3	4.58	57,9	2.28	15,5	.61	14,7	.58
FJ9787-1612S	*	*	44,5	1.75	-12	116,3	4.58	57,9	2.28	15,5	.61	14,7	.58
FJ9787-1616S	*	*	44,5	1.75	-16	135,4	5.33	70,1	2.76	19,8	.78	15,7	.62
FJ9787-2016S	*	*	50,8	2.00	-16	135,4	5.33	70,1	2.76	19,8	.78	15,7	.62
30° Elbow Split Flange - Code 62(SAEJ518)													
FJ9788-1212S	*	*	41,1	1.62	-12	116,3	4.58	57,9	2.28	15,5	.61	14,7	.58
FJ9788-1612S	*	*	47,8	1.88	-12	116,3	4.58	57,9	2.28	15,5	.61	14,7	.58
FJ9788-1616S	*	*	47,8	1.88	-16	135,4	5.33	70,1	2.76	19,8	.78	15,7	.62
FJ9788-2016S	*	*	53,8	2.12	-16	135,4	5.33	70,1	2.76	19,8	.78	15,7	.62

Note: For flanges, split flange halves, kits and o-rings, see pages 190-194

SPECIALTY & TRUCK HOSE
LOW & MEDIUM PRESSURE HOSE
HIGH PRESSURE HOSE
HOSE FITTINGS
ADAPTERS & TUBE FITTINGS
ACCESSORIES & ASSEMBLY INSTRUCTIONS
HOSE ASSEMBLY EQUIPMENT
APPENDICES

Spiral Single Skive Crimp Fittings

For use with Hose:
FC254, FC273

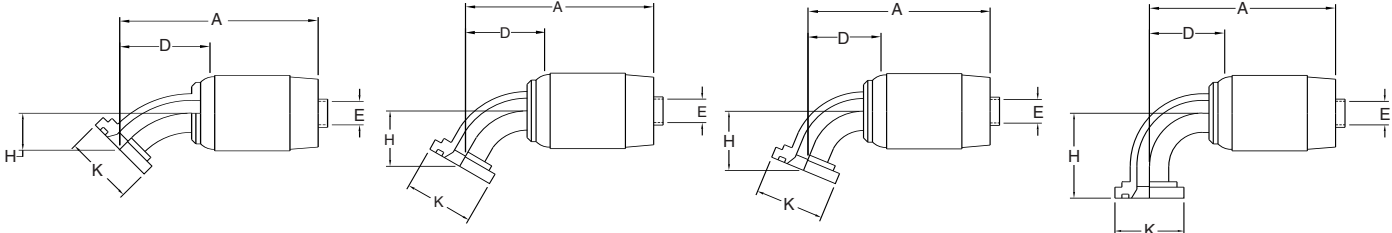

45° Elbow Split Flange
FJ9789 Code 61
FJ9790 Code 62

60° Elbow Split Flange
FJ9791 Code 61
FJ9792 Code 62

67 1/2° Elbow Split Flange
FJ9793 Code 61
FJ9794 Code 62

90° Elbow Split Flange
FJ9795 Code 61
FJ9796 Code 62

Complete Fitting Part #	Component Part Numbers		Flange Head Dia. K Ø	Hose Size	A		D		EØ		H	
	Nipple Assy. Part #	Socket Part #			mm	in	mm	in	mm	in	mm	in
45° Elbow split flange - Code 61 (SAEJ518)												
FJ9789-1212S	*	*	38,1 1.50	-12	122,9	4.84	64,3	2.53	15,5	.61	25,4	1.00
FJ9789-1612S	*	*	44,5 1.75	-12	122,9	4.84	64,3	2.53	15,5	.61	25,4	1.00
FJ9789-1616S	*	*	44,5 1.75	-16	141,7	5.58	76,5	3.01	19,8	.78	26,9	1.06
FJ9789-2016S	*	*	50,8 2.00	-16	141,7	5.58	76,5	3.01	19,8	.78	26,9	1.06
45° Elbow split flange - Code 62 (SAEJ518)												
FJ9790-1212S	*	*	41,1 1.62	-12	122,9	4.84	64,3	2.53	15,5	.61	25,4	1.00
FJ9790-1612S	*	*	47,8 1.88	-12	122,9	4.84	64,3	2.53	15,5	.61	25,4	1.00
FJ9790-1616S	*	*	47,8 1.88	-16	141,7	5.58	76,5	3.01	19,8	.78	26,9	1.06
FJ9790-2016S	*	*	53,8 2.12	-16	141,7	5.58	76,5	3.01	19,8	.78	26,9	1.06
60° Elbow split flange - Code 61 (SAEJ518)												
FJ9791-1212S	*	*	38,1 1.50	-12	123,7	4.87	65,0	2.56	15,5	.61	35,8	1.41
FJ9791-1612S	*	*	44,5 1.75	-12	123,7	4.87	65,0	2.56	15,5	.61	35,8	1.41
FJ9791-1616S	*	*	44,5 1.75	-16	142,5	5.61	77,5	3.05	19,8	.78	38,1	1.50
FJ9791-2016S	*	*	50,8 2.00	-16	142,5	5.61	77,5	3.05	19,8	.78	38,1	1.50
60° Elbow split flange - Code 62 (SAEJ518)												
FJ9792-1212S	*	*	41,1 1.62	-12	123,7	4.87	65,0	2.56	15,5	.61	35,8	1.41
FJ9792-1612S	*	*	47,8 1.88	-12	123,7	4.87	65,0	2.56	15,5	.61	35,8	1.41
FJ9792-1616S	*	*	47,8 1.88	-16	142,5	5.61	77,5	3.05	19,8	.78	38,1	1.50
FJ9792-2016S	*	*	53,8 2.12	-16	142,5	5.61	77,5	3.05	19,8	.78	38,1	1.50
67 1/2° Elbow split flange - Code 61 (SAEJ518)												
FJ9793-1212S	*	*	38,1 1.50	-12	122,4	4.82	63,8	2.51	15,5	.61	40,6	1.60
FJ9793-1612S	*	*	44,5 1.75	-12	122,4	4.82	63,8	2.51	15,5	.61	40,6	1.60
FJ9793-1616S	*	*	44,5 1.75	-16	143,0	5.63	78,0	3.07	19,8	.78	44,5	1.75
FJ9793-2016S	*	*	50,8 2.00	-16	143,0	5.63	78,0	3.07	19,8	.78	44,5	1.75
67 1/2° Elbow split flange - Code 62 (SAEJ518)												
FJ9794-1212S	*	*	41,1 1.62	-12	122,4	4.82	63,8	2.51	15,5	.61	40,6	1.60
FJ9794-1612S	*	*	47,8 1.88	-12	122,4	4.82	63,8	2.51	15,5	.61	40,6	1.60
FJ9794-1616S	*	*	47,8 1.88	-16	143,0	5.63	78,0	3.07	19,8	.78	44,5	1.75
FJ9794-2016S	*	*	53,8 2.12	-16	143,0	5.63	78,0	3.07	19,8	.78	44,5	1.75
90° Elbow split flange - Code 61 (SAEJ518)												
FJ9795-1212S	*	*	38,1 1.50	-12	115,6	4.55	56,9	2.24	15,5	.61	54,1	2.13
FJ9795-1612S	*	*	44,5 1.75	-12	115,6	4.55	56,9	2.24	15,5	.61	54,1	2.13
FJ9795-1616S	*	*	44,5 1.75	-16	136,9	5.39	71,6	2.82	19,8	.78	60,5	2.38
FJ9795-2016S	*	*	50,8 2.00	-16	136,9	5.39	71,6	2.82	19,8	.78	60,5	2.38
90° Elbow split flange - Code 62 (SAEJ518)												
FJ9796-1212S	*	*	41,1 1.62	-12	115,6	4.55	56,9	2.24	15,5	.61	54,1	2.13
FJ9796-1612S	*	*	47,8 1.88	-12	115,6	4.55	56,9	2.24	15,5	.61	54,1	2.13
FJ9796-1616S	*	*	47,8 1.88	-16	136,9	5.39	71,6	2.82	19,8	.78	60,5	2.38
FJ9796-2016S	*	*	53,8 2.12	-16	136,9	5.39	71,6	2.82	19,8	.78	60,5	2.38

Note: For flanges, split flange halves, kits and o-rings, see pages 190-195.

SPECIALTY & TRUCK HOSE
LOW & MEDIUM PRESSURE HOSE
HIGH PRESSURE HOSE
HOSE FITTINGS
ADAPTERS & TUBE FITTINGS
ACCESSORIES & ASSEMBLY INSTRUCTIONS
HOSE ASSEMBLY EQUIPMENT
APPENDICES

Spiral Single Skive Crimp Fittings

For use with Hose:
FC254, FC273

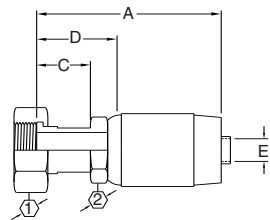

ORS Swivel Straight
FJ9900

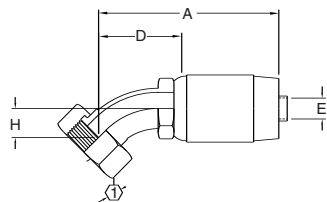

ORS Swivel 45° Elbow
FJ9901

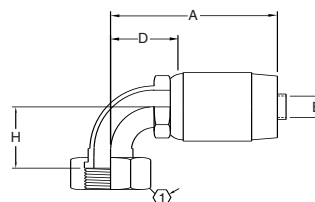

ORS Swivel 90° Elbow (short)
FJ9902

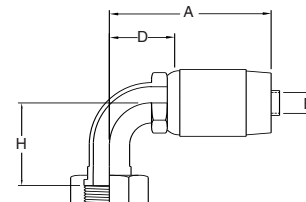

ORS Swivel 90° Elbow (long)
FJ9903

Complete Fitting Part #	Component Part Numbers		Thd.	Hose Size	A		C		D		EØ		H		①	②
	Nipple Assy. Part #	Socket Part #			mm	in	mm	in	mm	in	mm	in	mm	in		
Straight																
FJ9900-1212S	*	*	1 ³ / ₁₆ -12	-12	106,2	4.18	27,2	1.07	47,5	1.87	15,5	.61			1 ³ / ₈	1 ¹ / ₈
FJ9900-1616S	*	*	1 ⁷ / ₁₆ -12	-16	121,2	4.77	29,0	1.14	55,9	2.20	19,8	.78			1 ⁵ / ₈	1 ³ / ₈
45° Elbow																
FJ9901-1212S	*	*	1 ³ / ₁₆ -12	-12	118,4	4.66			59,7	2.35	15,5	.61	21,1	.83	1 ³ / ₈	
FJ9901-1616S	*	*	1 ⁷ / ₁₆ -12	-16	141,7	5.58			76,7	3.02	19,8	.78	23,9	.94	1 ⁵ / ₈	
90° Elbow (short)																
FJ9902-1212S	*	*	1 ³ / ₁₆ -12	-12	110,5	4.35			56,9	2.24	15,5	.61	47,8	1.88	1 ³ / ₈	
FJ9902-1616S	*	*	1 ⁷ / ₁₆ -12	-16	134,4	5.29			69,1	2.72	19,8	.78	56,1	2.21	1 ⁵ / ₈	
90° Elbow (long)																
FJ9903-1212S	*	*	1 ³ / ₁₆ -12	-12	115,6	4.55			56,9	2.24	15,5	.61	96,0	3.78	1 ³ / ₈	
FJ9903-1616S	*	*	1 ⁷ / ₁₆ -12	-16	136,9	5.39			71,6	2.82	19,8	.78	114,3	4.50	1 ⁵ / ₈	

Note: See pages 194, 195 for o-rings.

SPECIALTY & TRUCK HOSE

LOW & MEDIUM PRESSURE HOSE

HIGH PRESSURE HOSE

HOSE FITTINGS

ADAPTERS & TUBE FITTINGS

ACCESSORIES & ASSEMBLY INSTRUCTIONS

HOSE ASSEMBLY EQUIPMENT

APPENDICES

Internal Skive Crimp Fittings*

For use with Hose:

FC136 (-16 through -32), FC254, FC323, FC324 (-12, -16 only) FC736 (-16, -20 only)

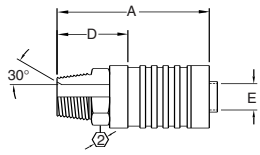

Male Pipe
FC5258

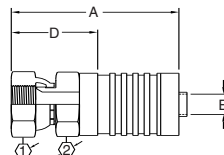

SAE 37° (JIC) Swivel
FC5014

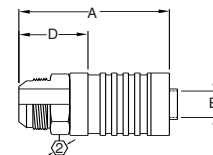

SAE 37° (JIC) Male Flare
FC5026

Complete Fitting Part #	Component Part Numbers Nipple Assy. Part #	Socket Part #	Thd.	Hose Size	A		D		EØ		①	②
					mm	in	mm	in	mm	in		
Male pipe												
FC5258-0608S	FC2710-0608S	FC2540-08S	3/8 -18	-08	74,5	3.09	32,8	1.29	9,1	.36		13/16
FC5258-0808S	FC2710-0808S	FC2540-08S	1/2 -14	-08	84,8	3.34	39,1	1.54	9,1	.36		7/8
FC5258-1212S	FC2710-1212S	FC2717-12S	3/4 -14	-12	90,4	3.56	36,6	1.44	15,5	.61		1 1/16
FC5258-1616S	FC2710-1616S	FC2540-16S	1 -11 1/2	-16	111,5	4.39	45,0	1.77	19,8	.78		1 3/8
FC5258-2016S	FC2710-2016S	FC2540-16S	1 1/4 -11 1/2	-16	113,8	4.48	47,2	1.86	19,8	.78		1 11/16
FC5258-2020S	FC2710-2020S	FC2540-20S	1 1/4 -11 1/2	-20	114,6	4.51	47,5	1.87	26,7	1.05		1 11/16
FC5258-2420S	FC2710-2420S	FC2540-20S	1 1/2 -11 1/2	-20	117,1	4.61	49,8	1.96	26,7	1.05		2
FC5258-2424S	FC2710-2424S	FC2540-24S	1 1/2 -11 1/2	-24	128,3	5.05	51,3	2.02	32,0	1.26		2
FC5258-3224S	FC2710-3224S	FC2540-24S	2 -11 1/2	-24	130,8	5.15	53,8	2.12	32,0	1.26		2 1/2
FC5258-3232S	FC2710-3232S	FC2540-32S	2 -11 1/2	-32	140,2	5.52	59,2	2.33	42,9	1.69		2 5/8

SAE 37° - (JIC) swivel

FC5014-0808S	FC4014-0808S	FC2540-08S	3/4 -16	-08	86,1	3.39	40,3	1.59	9,1	.36	15/16	13/16
FC5014-1212S	FC4014-1212S	FC2717-12S	1 1/16 -12	-12	96,7	3.81	43,8	1.70	15,5	.61	1 1/4	1 1/16
FC5014-1616S	FC4014-1616S	FC2540-16S	1 5/16 -12	-16	114,8	4.52	48,5	1.91	19,8	.78	1 1/2	1 1/4
FC5014-2020S	FC4014-2020S	FC2540-20S	1 5/8 -12	-20	121,2	4.77	53,8	2.12	26,7	1.05	2	1 9/16
FC5014-2420S	FC4014-2420S	FC2540-20S	1 7/8 -12	-20	126,5	4.98	59,2	2.33	26,7	1.05	2 1/4	1 13/16
FC5014-2424S	FC4014-2424S	FC2540-24S	1 7/8 -12	-24	137,9	5.43	60,9	2.40	32,0	1.26	2 1/4	1 13/16
FC5014-3232S	FC4014-3232S	FC2540-32S	2 1/2 -12	-32	139,7	5.50	58,6	2.31	42,9	1.69		2 7/8

SAE 37° - (JIC) male flare

FC5026-1212S	FC2697-1212S	FC2717-12S	1 1/16 -12	-12	94,7	3.73	41,1	1.62	15,5	.61		1 1/8
FC5026-1616S	FC2697-1616S	FC2540-16S	1 5/16 -12	-16	110,7	4.36	44,5	1.75	19,8	.78		1 3/8
FC5026-2020S	FC2697-2020S	FC2540-20S	1 5/8 -12	-20	112,7	4.44	45,7	1.80	26,7	1.05		1 5/8
FC5026-2424S	FC2697-2424S	FC2540-24S	1 7/8 -12	-24	128,7	5.07	51,8	2.04	32,0	1.26		1 7/8

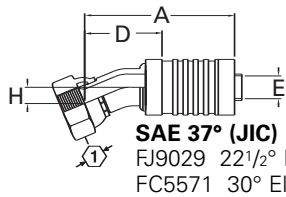

SAE 37° (JIC)
FJ9029 22 1/2° Elbow
FC5571 30° Elbow

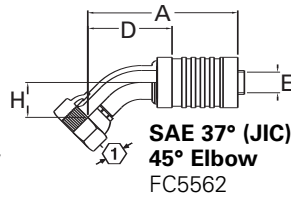

SAE 37° (JIC)
FC5562 45° Elbow

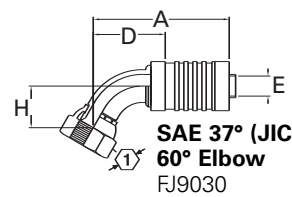

SAE 37° (JIC)
FJ9030 60° Elbow

Complete Fitting Part #	Component Part Numbers Nipple Assy. Part #	Socket Part #	Thd.	Hose Size	A		D		EØ		H	①	
					mm	in	mm	in	mm	in			mm
22 1/2° - Elbow													
FJ9029-1212S	FJ8029-1212S	FC2717-12S	1 1/16 -12	-12	114,0	4.49	60,2	2.37	15,5	.61	13,2	.52	1 1/2
FJ9029-1616S	FJ8029-1616S	FC2540-16S	1 5/16 -12	-16	145,0	5.71	78,7	3.10	19,8	.78	17,5	.69	1 1/2
FJ9029-2020S	FJ8029-2020S	FC2540-20S	1 5/8 -12	-20	156,2	6.15	88,9	3.50	26,7	1.05	20,3	.80	2
FJ9029-2424S	FJ8029-2424S	FC2540-24S	1 7/8 -12	-24	185,1	7.29	108,2	4.26	32,0	1.26	24,1	.95	2 1/2
30° Elbow													
FC5571-1212S	FC4571-1212S	FC2717-12S	1 1/16 -12	-12	112,2	4.42	58,6	2.31	15,5	.61	17,5	.69	1 1/2
FC5571-1616S	FC4571-1616S	FC2540-16S	1 5/16 -12	-16	146,8	5.78	80,2	3.16	19,8	.78	24,1	.95	1 1/2
FC5571-2020S	FC4571-2020S	FC2540-20S	1 5/8 -12	-20	159,5	6.28	92,2	3.63	26,7	1.05	28,2	1.11	2
FC5571-2424S	FC4571-2424S	FC2540-24S	1 7/8 -12	-24	186,9	7.36	110,2	4.34	32,0	1.26	32,8	1.29	2 1/2
45° Elbow													
FC5562-1212S	FC4562-1212S	FC2717-12S	1 1/16 -12	-12	117,9	4.64	64,0	2.52	15,5	.61	29,5	1.16	1 1/2
FC5562-1616S	FC4562-1616S	FC2540-16S	1 5/16 -12	-16	150,4	5.92	83,8	3.30	19,8	.78	38,9	1.53	1 1/2
FC5562-2020S	FC4562-2020S	FC2540-20S	1 5/8 -12	-20	158,5	6.24	91,4	3.60	26,7	1.05	43,8	1.70	2
FC5562-2424S	FC4562-2424S	FC2540-24S	1 7/8 -12	-24	186,7	7.35	109,7	4.32	32,0	1.26	50,5	1.99	2 1/2
60° Elbow													
FJ9030-1212S	FJ8030-1212S	FC2717-12S	1 1/16 -12	-12	117,3	4.62	63,8	2.51	15,5	.61	40,6	1.60	1 1/2
FJ5026-1616S	FJ2697-1616S	FC2540-16S	1 5/16 -12	-16	147,8	5.82	81,3	3.20	19,8	.78	52,8	2.08	1 1/2
FJ5026-2020S	FJ2697-2020S	FC2540-20S	1 5/8 -12	-20	157,0	6.18	89,9	3.54	26,7	1.05	59,2	2.33	2
FJ5026-2424S	FJ2697-2424S	FC2540-24S	1 7/8 -12	-24	183,9	7.24	106,9	4.21	32,0	1.26	69,1	2.72	2 1/2

*Internal skive crimp fittings cannot be crimped on FT1244 machines, except as follows: FC5258-0608S, FC5258-0808S, and FC5014-0808S fittings can be crimped on FT1244 machines by using special equipment and procedures.

SPECIALTY & TRUCK HOSE

LOW & MEDIUM PRESSURE HOSE

HIGH PRESSURE HOSE

HOSE FITTINGS

ADAPTERS & TUBE FITTINGS

ACCESSORIES & ASSEMBLY INSTRUCTIONS

HOSE ASSEMBLY EQUIPMENT

APPENDICES

Internal Skive Crimp Fittings*

For use with Hose:

FC136 (-16 through -32), FC254,
FC323, FC324 (-12, -16 only)
FC736 (-16, -20 only)

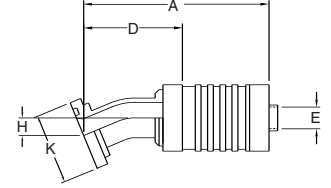
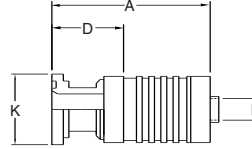
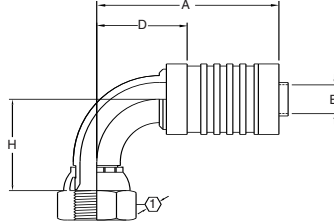
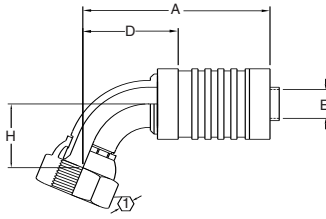

SAE 37° (JIC) 67 1/2° Elbow
FJ9031

SAE 37° (JIC) 90 Elbow
FC5564

Straight Split Flange
FC5050 Code 61
FC5049 Code 62

22 1/2° Elbow Split Flange
FC5507 Code 61

Complete Fitting Part #	Component Part Numbers		Flange Head Dia. K Ø	Hose Size	A		D		EØ		H		①	②
	Nipple Assy. Part #	Socket Part #			mm	in	mm	in	mm	in	mm	in		
67 1/2° Elbow														
FJ9031-1212S	FJ8031-1212S	FC2717-12S	1 1/16 -12	-12	115,6	4.55	61,7	2.43	15,5	.61	45,7	1.80		1 1/4
FJ9031-1616S	FJ8031-1616S	FC2540-16S	1 5/16 -12	-16	146,3	5.76	79,8	3.14	19,8	.78	59,9	2.36		1 1/2
FJ9031-2020S	FJ8031-2020S	FC2540-20S	1 5/8 -12	-20	153,9	6.06	86,6	3.41	26,7	1.05	66,5	2.62		2
FJ9031-2424S	FJ8031-2424S	FC2540-24S	1 7/8 -12	-24	169,4	6.67	92,5	3.64	32,0	1.26	70,1	2.76		2 1/4
90° Elbow														
FC5564-1212S	FC4564-1212S	FC2717-12S	1 1/16 -12	-12	106,7	4.20	52,8	2.08	15,5	.61	59,7	2.35		1 1/4
FC5564-1616S	FC4564-1616S	FC2540-16S	1 5/16 -12	-16	133,6	5.26	67,1	2.64	19,8	.78	77,2	3.04		1 1/2
FC5564-2020S	FC4564-2020S	FC2540-20S	1 5/8 -12	-20	140,7	5.54	73,7	2.90	26,7	1.05	86,4	3.40		2
FC5564-2424S	FC4564-2424S	FC2540-24S	1 7/8 -12	-24	164,6	6.48	87,9	3.46	32,0	1.26	100,3	3.95		2 1/4
Straight split flange — Code 61 (SAE J518)														
FC5050-1212S	FC4050-1212S	FC2717-12S	38,1 1.50	-12	115,8	4.56	62,0	2.44	15,5	.61				
FC5050-1616S	FC4050-1616S	FC2540-16S	44,5 1.75	-16	142,5	5.61	76,2	3.00	19,8	.78				
FC5050-2016S	FC4050-2016S	FC2540-16S	50,8 2.00	-16	142,5	5.61	76,2	3.00	19,8	.78				
FC5050-2416S	FC4050-2416S	FC2540-16S	60,5 2.38	-16	142,5	5.61	76,2	3.00	19,8	.78				
FC5050-2020S	FC4050-2020S	FC2540-20S	50,8 2.00	-20	144,3	5.68	77,0	3.03	26,7	1.05				
FC5050-2420S	FC4050-2420S	FC2540-20S	60,5 2.38	-20	144,3	5.68	77,0	3.03	26,7	1.05				
FC5050-3220S	FC4050-3220S	FC2540-20S	71,4 2.81	-20	144,3	5.68	77,0	3.03	26,7	1.05				
FC5050-2424S	FC4050-2424S	FC2540-24S	60,5 2.38	-24	173,5	6.83	96,5	3.80	32,0	1.26				
FC5050-3224S	FC4050-3224S	FC2540-24S	71,4 2.81	-24	173,5	6.83	96,5	3.80	32,0	1.26				
FC5050-3232S	FC4050-3232S	FC2540-32S	71,4 2.81	-32	202,7	7.98	121,9	4.80	42,9	1.69				
Straight split flange — Code 62 (SAE J518)														
FC5049-1212S	FC4049-1212S	FC2717-12S	41,1 1.62	-12	115,8	4.56	62,0	2.44	15,5	.61				
FC5049-1616S	FC4049-1616S	FC2540-16S	47,8 1.88	-16	142,5	5.61	76,2	3.00	19,8	.78				
FC5049-2016S	FC4049-2016S	FC2540-16S	53,8 2.12	-16	142,5	5.61	76,2	3.00	19,8	.78				
FC5049-2416S	FC4049-2416S	FC2540-16S	63,5 2.50	-16	142,5	5.61	76,2	3.00	19,8	.78				
FC5049-2020S	FC4049-2020S	FC2540-20S	53,8 2.12	-20	144,3	5.68	77,0	3.03	26,7	1.05				
FC5049-2420S	FC4049-2420S	FC2540-20S	63,5 2.50	-20	144,3	5.68	77,0	3.03	26,7	1.05				
FC5049-3220S	FC4049-3220S	FC2540-20S	79,2 3.12	-20	144,3	5.68	77,0	3.03	26,7	1.05				
FC5049-2424S	FC4049-2424S	FC2540-24S	63,5 2.50	-24	173,2	6.82	96,5	3.80	32,0	1.26				
FC5049-3224S	FC4049-3224S	FC2540-24S	79,2 3.12	-24	173,2	6.82	96,5	3.80	32,0	1.26				
FC5049-3232S	FC4049-3232S	FC2540-32S	79,2 3.12	-32	202,7	7.98	121,9	4.80	42,9	1.69				
22 1/2° Elbow split flange — Code 61 (SAE J518)														
FC5507-1616S	FC4507-1616S	FC2540-16S	44,5 1.75	-16	129,5	5.10	63,0	2.48	19,8	.78	11,2	.44		
FC5507-2016S	FC4507-2016S	FC2540-16S	50,8 2.00	-16	129,5	5.10	63,0	2.48	19,8	.78	11,2	.44		
FC5507-2020S	FC4507-2020S	FC2540-20S	50,8 2.00	-20	138,2	5.44	70,9	2.79	26,7	1.05	12,7	.50		
FC5507-2420S	FC4507-2420S	FC2540-20S	60,5 2.38	-20	137,7	5.42	70,6	2.78	26,7	1.05	12,7	.50		
FC5507-2424S	FC4507-2424S	FC2540-24S	60,5 2.38	-24	165,9	6.53	88,9	3.50	32,0	1.26	16,0	.63		
FC5507-3224S	FC4507-3224S	FC2540-24S	71,4 2.81	-24	165,9	6.53	88,9	3.50	32,0	1.26	16,0	.63		
FC5507-3232S	FC4507-3232S	FC2540-32S	71,4 2.81	-32	202,7	7.98	121,9	4.80	42,9	1.69	22,4	.88		

Note: For flanges, split flange halves, kits and o-rings, see pages 190-195.

*Internal skive crimp fittings cannot be crimped on FT1244 machines, except as follows: FC5258-0608S, FC5258-0808S, and FC5014-0808S fittings can be crimped on FT1244 machines by using special equipment and procedures.

SPECIALTY & TRUCK HOSE
LOW & MEDIUM PRESSURE HOSE
HIGH PRESSURE HOSE
HOSE FITTINGS
ADAPTERS & TUBE FITTINGS
ACCESSORIES & ASSEMBLY INSTRUCTIONS
HOSE ASSEMBLY EQUIPMENT
APPENDICES

Internal Skive Crimp Fittings*

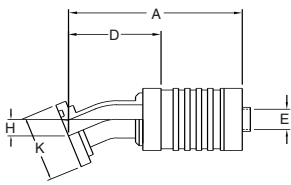

22 1/2° Elbow Split Flange
FC5374 Code 62

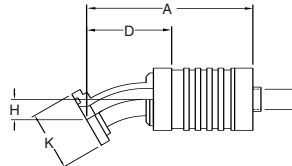

30° Elbow Split Flange
FC5612 Code 61
FC5387 Code 62

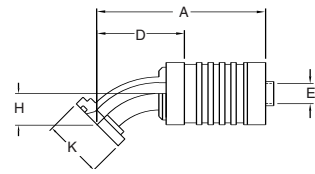

45° Elbow Split Flange
FC5052 Code 61
FC5051 Code 62

For use with Hose:

FC136 (-16 through -32), FC254,
FC323, FC324 (-12, -16 only)
FC736 (-16, -20 only)

Complete Fitting Part #	Component Part Numbers		Flange Head Dia. K Ø	Hose Size	A		D		E Ø		H		
	Nipple Assy. Part #	Socket Part #			mm	in	mm	in	mm	in	mm	in	
22 1/2° Elbow split flange — Code 62 (SAE J518)													
FC5374-1212S	FC4374-1212S	FC2717-12S	41,1	1.62	-12	108,7	4.28	55,1	2.17	15,5	.61	11,2	.44
FC5374-1616S	FC4374-1616S	FC2540-16S	47,8	1.88	-16	129,5	5.10	63,0	2.48	19,8	.78	11,2	.44
FC5374-2016S	FC4374-2016S	FC2540-16S	53,8	2.12	-16	129,5	5.10	63,0	2.48	19,8	.78	11,2	.44
FC5374-2020S	FC4374-2020S	FC2540-20S	53,8	2.12	-20	138,2	5.44	70,9	2.79	26,7	1.05	12,7	.50
FC5374-2420S	FC4374-2420S	FC2540-20S	63,5	2.50	-20	138,2	5.44	70,9	2.79	26,7	1.05	12,7	.50
FC5374-2424S	FC4374-2424S	FC2540-24S	63,5	2.50	-24	165,9	6.53	88,9	3.50	32,0	1.26	16,0	.63
FC5374-3224S	FC4374-3224S	FC2540-24S	79,2	3.12	-24	165,9	6.53	88,9	3.50	32,0	1.26	16,0	.63
FC5374-3232S	FC4374-3232S	FC2540-32S	79,2	3.12	-32	202,7	7.98	121,9	4.80	42,9	1.69	22,4	.88
30° Elbow split flange — Code 61 (SAE J518)													
FC5612-1212S	FC4612-1212S	FC2717-12S	38,1	1.50	-12	107,4	4.23	53,8	2.12	15,5	.61	14,7	.58
FC5612-1616S	FC4612-1616S	FC2540-16S	44,5	1.75	-16	132,1	5.20	65,5	2.58	19,8	.78	15,7	.62
FC5612-2016S	FC4612-2016S	FC2540-16S	50,8	2.00	-16	132,1	5.20	65,5	2.58	19,8	.78	15,7	.62
FC5612-2020S	FC4612-2020S	FC2540-20S	50,8	2.00	-20	142,5	5.61	75,2	2.96	26,7	1.05	18,3	.72
FC5612-2420S	FC4612-2420S	FC2540-20S	60,5	2.38	-20	142,5	5.61	75,2	2.96	26,7	1.05	18,3	.72
FC5612-2424S	FC4612-2424S	FC2540-24S	60,5	2.38	-24	168,7	6.64	91,7	3.61	32,0	1.26	22,4	.88
FC5612-3224S	FC4612-3224S	FC2540-24S	71,4	2.81	-24	168,7	6.64	91,7	3.61	32,0	1.26	22,4	.88
FC5612-3232S	FC4612-3232S	FC2540-32S	71,4	2.81	-32	208,8	8.22	128,0	5.04	42,9	1.69	31,8	1.25
30° Elbow split flange — Code 62 (SAE J518)													
FC5387-1212S	FC4387-1212S	FC2717-12S	41,1	1.62	-12	107,4	4.23	53,8	2.12	15,5	.61	14,7	.58
FC5387-1616S	FC4387-1616S	FC2540-16S	47,8	1.88	-16	132,1	5.20	65,5	2.58	19,8	.78	15,7	.62
FC5387-2016S	FC4387-2016S	FC2540-16S	53,8	2.12	-16	132,1	5.20	65,5	2.58	19,8	.78	15,7	.62
FC5387-2020S	FC4387-2020S	FC2540-20S	53,8	2.12	-20	142,5	5.61	75,2	2.96	26,7	1.05	18,3	.72
FC5387-2420S	FC4387-2420S	FC2540-20S	63,5	2.50	-20	142,5	5.61	75,2	2.96	26,7	1.05	18,3	.72
FC5387-2424S	FC4387-2424S	FC2540-24S	63,5	2.50	-24	168,7	6.64	91,7	3.61	32,0	1.26	22,4	.88
FC5387-3224S	FC4387-3224S	FC2540-24S	79,2	3.12	-24	168,7	6.64	91,7	3.61	32,0	1.26	22,4	.88
FC5387-3232S	FC4387-3232S	FC2540-32S	79,2	3.12	-32	208,8	8.22	128,0	5.04	42,9	1.69	31,8	1.25
45° Elbow split flange — Code 61 (SAE J518)													
FC5052-1212S	FC4052-1212S	FC2717-12S	38,1	1.50	-12	113,8	4.48	60,2	2.37	15,5	.61	25,4	1.00
FC5052-1616S	FC4052-1616S	FC2540-16S	44,5	1.75	-16	138,2	5.44	71,9	2.83	19,8	.78	26,9	1.06
FC5052-2016S	FC4052-2016S	FC2540-16S	50,8	2.00	-16	138,2	5.44	71,9	2.83	19,8	.78	26,9	1.06
FC5052-2020S	FC4052-2020S	FC2540-20S	50,8	2.00	-20	144,8	5.70	77,5	3.05	26,7	1.05	29,2	1.15
FC5052-2420S	FC4052-2420S	FC2540-20S	60,5	2.38	-20	144,8	5.70	77,5	3.05	26,7	1.05	29,2	1.15
FC5052-2424S	FC4052-2424S	FC2540-24S	60,5	2.38	-24	171,7	6.76	95,0	3.74	32,0	1.26	35,8	1.41
FC5052-3224S	FC4052-3224S	FC2540-24S	71,4	2.81	-24	171,7	6.76	95,0	3.74	32,0	1.26	35,8	1.41
FC5052-3232S	FC4052-3232S	FC2540-32S	71,4	2.81	-32	213,1	8.39	132,1	5.20	42,9	1.69	50,8	2.00
45° Elbow split flange — Code 62 (SAE J518)													
FC5051-1212S	FC4051-1212S	FC2717-12S	41,1	1.62	-12	113,8	4.48	60,2	2.37	15,5	.61	25,4	1.00
FC5051-1616S	FC4051-1616S	FC2540-16S	47,8	1.88	-16	138,2	5.44	71,9	2.83	19,8	.78	26,9	1.06
FC5051-2016S	FC4051-2016S	FC2540-16S	53,8	2.12	-16	138,2	5.44	71,9	2.83	19,8	.78	26,9	1.06
FC5051-2020S	FC4051-2020S	FC2540-20S	53,8	2.12	-20	144,8	5.70	77,5	3.05	26,7	1.05	29,2	1.15
FC5051-2420S	FC4051-2420S	FC2540-20S	63,5	2.50	-20	144,8	5.70	77,5	3.05	26,7	1.05	29,2	1.15
FC5051-2424S	FC4051-2424S	FC2540-24S	63,5	2.50	-24	171,7	6.76	95,0	3.74	32,0	1.26	35,8	1.41
FC5051-3224S	FC4051-3224S	FC2540-24S	79,2	3.12	-24	171,7	6.76	95,0	3.74	32,0	1.26	35,8	1.41
FC5051-3232S	FC4051-3232S	FC2540-32S	79,2	3.12	-32	213,1	8.39	132,1	5.20	42,9	1.69	50,8	2.00

NOTE: For flanges, split flange halves, kits and o-rings, see pages 190-195.

*Internal skive crimp fittings cannot be crimped on FT1244 machines, except as follows: FC5258-0608S, FC5258-0808S and FC5014-0808S fittings can be crimped on FT1244 machines by using special equipment and procedures.

Internal Skive Crimp Fittings*

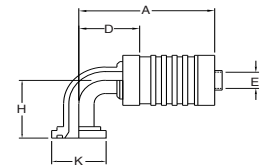
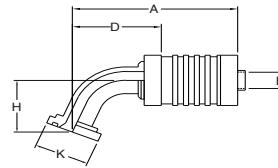
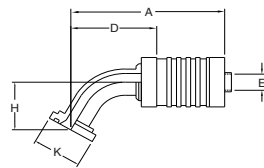

For use with Hose:

FC136 (-16 through -32), FC254, FC323, FC324 (-12, -16 only), FC736 (-16, -20 only)

60° Elbow Split Flange
FC5504 Code 61
FC5582 Code 62

67 1/2° Elbow Split Flange
FC5513 Code 61
FC5373 Code 62

90° Elbow Split Flange
FC5054 Code 61

Complete Fitting Part #	Component Part Numbers		Flange Head Dia. K Ø	Hose Size	A		D		EØ		H		
	Nipple Assy. Part #	Socket Part #			mm	in	mm	in	mm	in	mm	in	
60° Elbow split flange — Code 61 (SAE J518)													
FC5504-1616S	FC4504-1616S	FC2540-16S	44,5	1.75	-16	134,4	5.29	72,9	2.87	19,3	.76	38,1	1.50
FC5504-2016S	FC4504-2016S	FC2540-16S	50,8	2.00	-16	134,4	5.29	72,9	2.87	19,3	.76	38,1	1.50
FC5504-2020S	FC4504-2020S	FC2540-20S	50,8	2.00	-20	142,5	5.61	80,0	3.15	23,9	.94	42,2	1.66
FC5504-2420S	FC4504-2420S	FC2540-20S	60,5	2.38	-20	142,5	5.61	80,0	3.15	23,9	.94	42,2	1.66
FC5504-2424S	FC4504-2424S	FC2540-24S	60,5	2.38	-24	168,7	6.64	96,5	3.80	28,4	1.12	50,8	2.00
FC5504-3224S	FC4504-3224S	FC2540-24S	71,4	2.81	-24	168,7	6.64	96,5	3.80	28,4	1.12	50,8	2.00
FC5504-3232S	FC4504-3232S	FC2540-32S	71,4	2.81	-32	213,1	8.39	136,1	5.36	41,1	1.62	73,2	2.88
60° Elbow split flange — Code 62 (SAE J518)													
FC5582-1616S	FC4582-1616S	FC2540-16S	47,8	1.88	-16	134,4	5.29	72,9	2.87	19,3	.76	38,1	1.50
FC5582-2016S	FC4582-2016S	FC2540-16S	53,8	2.12	-16	134,4	5.29	72,9	2.87	19,3	.76	38,1	1.50
FC5582-2020S	FC4582-2020S	FC2540-20S	53,8	2.12	-20	142,5	5.61	80,0	3.15	23,9	.94	42,2	1.66
FC5582-2420S	FC4582-2420S	FC2540-20S	63,5	2.50	-20	142,5	5.61	80,0	3.15	23,9	.94	42,2	1.66
FC5582-2424S	FC4582-2424S	FC2540-24S	63,5	2.50	-24	168,7	6.64	96,5	3.80	28,4	1.12	50,8	2.00
FC5582-3224S	FC4582-3224S	FC2540-24S	79,2	3.12	-24	168,7	6.64	96,5	3.80	28,4	1.12	50,8	2.00
FC5582-3232S	FC4582-3232S	FC2540-32S	79,2	3.12	-32	213,1	8.39	136,1	5.36	41,1	1.62	73,2	2.88
67 1/2° Elbow split flange — Code 61 (SAE J518)													
FC5513-1212S	FC4513-1212S	FC2717-12S	38,1	1.50	-12	108,5	4.27	59,7	2.35	14,2	.56	40,6	1.60
FC5513-1616S	FC4513-1616S	FC2540-16S	44,5	1.75	-16	135,1	5.32	73,4	2.89	19,3	.76	44,5	1.75
FC5513-2016S	FC4513-2016S	FC2540-16S	50,8	2.00	-16	135,1	5.32	73,4	2.89	19,3	.76	44,5	1.75
FC5513-2020S	FC4513-2020S	FC2540-20S	50,8	2.00	-20	141,7	5.58	79,2	3.12	23,9	.94	48,3	1.90
FC5513-2420S	FC4513-2420S	FC2540-20S	60,5	2.38	-20	141,7	5.58	79,2	3.12	23,9	.94	48,3	1.90
FC5513-2424S	FC4513-2424S	FC2540-24S	60,5	2.38	-24	156,7	6.17	84,6	3.33	28,4	1.12	50,8	2.00
FC5513-3224S	FC4513-3224S	FC2540-24S	71,4	2.81	-24	156,7	6.17	84,6	3.33	28,4	1.12	50,8	2.00
FC5513-3232S	FC4513-3232S	FC2540-32S	71,4	2.81	-32	210,1	8.27	133,1	5.24	41,1	1.62	82,6	3.25
67 1/2° Elbow split flange — Code 62 (SAE J518)													
FC5373-1212S	FC4373-1212S	FC2717-12S	41,1	1.62	-12	108,5	4.27	59,7	2.35	14,2	.56	40,6	1.60
FC5373-1616S	FC4373-1616S	FC2540-16S	47,8	1.88	-16	135,1	5.32	73,4	2.89	19,3	.76	44,5	1.75
FC5373-2016S	FC4373-2016S	FC2540-16S	53,8	2.12	-16	135,1	5.32	73,4	2.89	19,3	.76	44,5	1.75
FC5373-2020S	FC4373-2020S	FC2540-20S	53,8	2.12	-20	141,7	5.58	79,2	3.12	23,9	.94	48,3	1.90
FC5373-2420S	FC4373-2420S	FC2540-20S	63,5	2.50	-20	141,7	5.58	79,2	3.12	23,9	.94	48,3	1.90
FC5373-2424S	FC4373-2424S	FC2540-24S	63,5	2.50	-24	156,7	6.17	84,6	3.33	28,4	1.12	50,8	2.00
FC5373-3224S	FC4373-3224S	FC2540-24S	79,2	3.12	-24	156,7	6.17	84,6	3.33	28,4	1.12	50,8	2.00
FC5373-3232S	FC4373-3232S	FC2540-32S	79,2	3.12	-32	210,1	8.27	133,1	5.24	41,1	1.62	82,6	3.25
90° Elbow split flange — Code 61 (SAE J518)													
FC5054-1212S	FC4054-1212S	FC2717-12S	38,1	1.50	-12	101,9	4.01	52,8	2.08	14,2	.56	54,1	2.13
FC5054-1616S	FC4054-1616S	FC2540-16S	44,5	1.75	-16	128,7	5.07	67,3	2.65	19,3	.76	60,5	2.38
FC5054-2016S	FC4054-2016S	FC2540-16S	50,8	2.00	-16	128,7	5.07	67,3	2.65	19,3	.76	60,5	2.38
FC5054-2020S	FC4054-2020S	FC2540-20S	50,8	2.00	-20	136,1	5.36	73,7	2.90	23,9	.94	66,8	2.63
FC5054-2420S	FC4054-2420S	FC2540-20S	60,5	2.38	-20	136,1	5.36	73,7	2.90	23,9	.94	66,8	2.63
FC5054-2424S	FC4054-2424S	FC2540-24S	60,5	2.38	-24	160,0	6.30	87,9	3.46	28,4	1.12	79,5	3.13
FC5054-3224S	FC4054-3224S	FC2540-24S	71,4	2.81	-24	160,0	6.30	87,9	3.46	28,4	1.12	79,5	3.13
FC5054-3232S	FC4054-3232S	FC2540-32S	71,4	2.81	-32	200,9	7.91	124,0	4.88	41,1	1.62	114,3	4.50

NOTE: For flanges, split flange halves, kits and o-rings, see pages 190-195.

*Internal skive crimp fittings cannot be crimped on FT1244 machines, except as follows: FC5258-0608S, FC5258-0808S and FC5014-0808S fittings can be crimped on FT1244 machines by using special equipment and procedures.

SPECIALTY & TRUCK HOSE

LOW & MEDIUM PRESSURE HOSE

HIGH PRESSURE HOSE

HOSE FITTINGS

ADAPTERS & TUBE FITTINGS

ACCESSORIES & ASSEMBLY INSTRUCTIONS

HOSE ASSEMBLY EQUIPMENT

APPENDICES

Internal Skive Crimp Fittings*

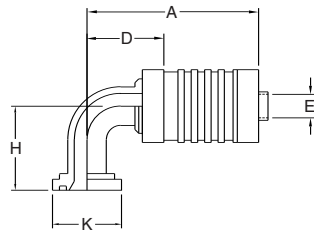

For use with Hose:

FC136 (-16 through -32), FC254, FC323, FC324 (-12, -16 only) FC736 (-16, -20 only)

90° Elbow Split Flange
FC5053 Code 62

Complete Fitting Part #	Component Nipple Assy. Part #	Part Numbers Socket Part #	Flange Head Dia. K Ø		Hose Size	A		D		EØ		H	
			mm	in		mm	in	mm	in	mm	in	mm	in
90° Elbow split flange — Code 62 (SAE J518)													
FC5053-1212S	FC4053-1212S	FC2717-12S	41,1	1.62	-12	101,9	4.01	52,8	2.08	14,2	.56	54,1	2.13
FC5053-1616S	FC4053-1616S	FC2540-16S	47,8	1.88	-16	128,7	5.07	67,3	2.65	19,3	.76	60,5	2.38
FC5053-2016S	FC4053-2016S	FC2540-16S	53,8	2.12	-16	128,7	5.07	67,3	2.65	19,3	.76	60,5	2.38
FC5053-2020S	FC4053-2020S	FC2540-20S	53,8	2.12	-20	136,1	5.36	73,7	2.90	23,9	.94	66,8	2.63
FC5053-2420S	FC4053-2420S	FC2540-20S	63,5	2.50	-20	136,1	5.36	73,7	2.90	23,9	.94	66,8	2.63
FC5053-2424S	FC4053-2424S	FC2540-24S	63,5	2.50	-24	160,0	6.30	87,9	3.46	28,4	1.12	79,5	3.13
FC5053-3224S	FC4053-3224S	FC2540-24S	79,2	3.12	-24	160,0	6.30	87,9	3.46	28,4	1.12	79,5	3.13
FC5053-3232S	FC4053-3232S	FC2540-32S	79,2	3.12	-32	200,9	7.91	124,0	4.88	41,1	1.62	114,3	4.50

Note: For flanges, split flange halves, kits and o-rings, see pages 190-195.

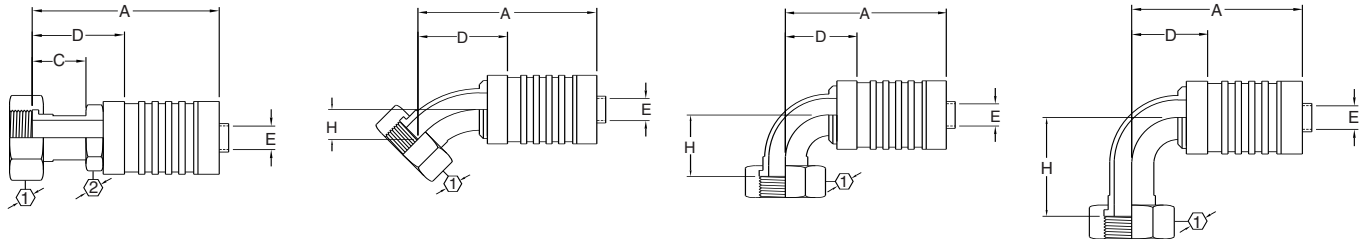

ORS Swivel Straight
FJ9608

ORS Swivel 45° Elbow
FJ9611

ORS Swivel 90° Elbow (short)
FJ9614

ORS Swivel 90° Elbow (long)
FJ9717

Complete Fitting Part #	Component Nipple Assy. Part #	Part Numbers Socket Part #	Thd.	Hose Size	A		C	D	EØ	H	①	②				
					mm	in							mm	in	mm	in
Straight																
FJ9608-1212S	FJ8608-1212S	FC2717-12S	1 ³ / ₁₆ - 12	-12	97,0	3.82	27,2	1.07	43,8	1.70	15,5	.61	1 ³ / ₈	1 ¹ / ₈		
FJ9608-1616S	FJ8608-1616S	FC2540-16S	1 ⁷ / ₁₆ - 12	-16	117,9	4.64	29,0	1.14	51,6	2.03	19,8	.78	1 ⁵ / ₈	1 ³ / ₈		
FJ9608-2020S	FJ8608-2020S	FC2540-20S	1 ¹¹ / ₁₆ - 12	-20	118,9	4.68	28,7	1.13	51,6	2.03	26,7	1.05	1 ⁷ / ₈	1 ⁵ / ₈		
FJ9608-2424S	FJ8608-2424S	FC2540-24S	2 - 12	-24	130,0	5.12	25,4	1.00	53,1	2.09	32,0	1.26	2 ¹ / ₄	2		
45° Elbow																
FJ9611-1212S	FJ8611-1212S	FC2717-12S	1 ³ / ₁₆ - 12	-12	109,2	4.30			55,6	2.19	14,2	.56	14,2	.56	1 ³ / ₈	
FJ9611-1616S	FJ8611-1616S	FC2540-16S	1 ⁷ / ₁₆ - 12	-16	138,4	5.45			72,1	2.84	19,3	.76	19,3	.76	1 ⁵ / ₈	
FJ9611-2020S	FJ8611-2020S	FC2540-20S	1 ¹¹ / ₁₆ - 12	-20	137,2	5.40			69,9	2.75	25,7	1.01	25,7	1.01	1 ⁷ / ₈	
FJ9611-2424S	FJ8611-2424S	FC2540-24S	2 - 12	-24	162,3	6.39			85,3	3.36	27,2	1.07	27,2	1.07	2 ¹ / ₄	
90° Elbow (short)																
FJ9614-1212S	FJ8614-1212S	FC2717-12S	1 ³ / ₁₆ - 12	-12	106,7	4.20			52,8	2.08	14,2	.56	47,8	1.88	1 ³ / ₈	
FJ9614-1616S	FJ8614-1616S	FC2540-16S	1 ⁷ / ₁₆ - 12	-16	131,1	5.16			64,5	2.54	19,3	.76	56,1	2.21	1 ⁵ / ₈	
FJ9614-2020S	FJ8614-2020S	FC2540-20S	1 ¹¹ / ₁₆ - 12	-20	139,2	5.48			72,1	2.84	25,7	1.01	63,8	2.51	1 ⁷ / ₈	
FJ9614-2424S	FJ8614-2424S	FC2540-24S	2 - 12	-24	164,6	6.48			87,9	3.46	30,2	1.19	68,6	2.70	2 ¹ / ₄	
90° Elbow (long)																
FJ9717-1212S	FJ8717-1212S	FC2717-12S	1 ³ / ₁₆ - 12	-12	106,7	4.20			52,8	2.08	14,2	.56	47,8	1.88	1 ³ / ₈	
FJ9717-1616S	FJ8717-1616S	FC2540-16S	1 ⁷ / ₁₆ - 12	-16	133,6	5.26			64,5	2.54	19,3	.76	56,1	2.21	1 ⁵ / ₈	
FJ9717-2020S	FJ8717-2020S	FC2540-20S	1 ¹¹ / ₁₆ - 12	-20	140,7	5.54			73,7	2.90	25,7	1.01	63,8	2.51	1 ⁷ / ₈	
FJ9717-2424S	FJ8717-2424S	FC2540-24S	2 - 12	-24	164,6	6.48			87,9	3.46	27,2	1.07	68,6	2.70	2 ¹ / ₄	

*Internal skive crimp fittings cannot be crimped on FT1244 machines, except as follows: FC5258-0608S, FC5258-0808S, and FC5014-0808S fittings can be crimped on FT1244 machines by using special equipment and procedures.

Internal Skive Crimp Fittings*

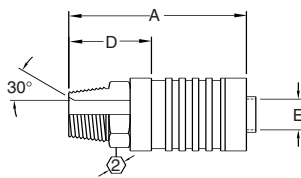

Male Pipe
FC5322

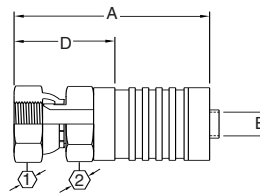

SAE 37° (JIC) Swivel
FC5321

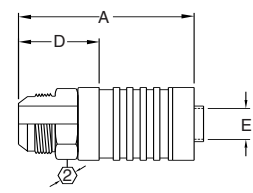

SAE 37° (JIC) Male Flare
FC5323

For use with Hose:

FC273, FC325

Complete Fitting Part #	Component Part Numbers		Thd.	Hose Size	A		D		EØ		①	②
	Nipple Assy. Part #	Socket Part #			mm	in	mm	in	mm	in		
Male pipe												
FC5322-1212S	FC2710-1212S	FC2717-12S	3/4 - 14	-12	90,4	3.56	36,6	1.44	15,5	.61		1 1/16
FC5322-1616S	FC2710-1616S	FC2540-16S	1 - 11 1/2	-16	111,5	4.39	45,0	1.77	19,8	.78		1 3/8
FC5322-2020S	FC2710-2020S	FC2717-20S	1 1/4 - 11 1/2	-20	114,6	4.51	47,5	1.87	26,7	1.05		1 5/8
FC5322-2424S	FC2710-2424S	FC2717-24S	1 1/2 - 11 1/2	-24	128,7	5.07	51,3	2.02	32,0	1.26		2
FC5322-3232S	FC2710-3232S	FC2717-32S	2 - 11 1/2	-32	136,1	5.36	59,2	2.33	42,9	1.69		2 5/8
SAE 37° (JIC) swivel												
FC5321-1212S	FC4014-1212S	FC2717-12S	1 1/16 - 12	-12	96,7	3.81	43,8	1.70	15,5	.61	1 1/4	1 1/16
FC5321-1616S	FC4014-1616S	FC2540-16S	1 5/16 - 12	-16	114,8	4.52	48,5	1.91	19,8	.78	1 1/2	1 1/4
FC5321-2020S	FC4014-2020S	FC2717-20S	1 5/8 - 12	-20	121,2	4.77	53,8	2.12	26,7	1.05	2	1 1/2
FC5321-2420S	FC4014-2020S	FC2717-20S	1 7/8 - 12	-20	126,5	4.98	59,2	2.33	26,7	1.05	2 1/4	1 13/16
FC5321-2424S	FC4014-2424S	FC2717-24S	1 7/8 - 12	-24	138,4	5.45	60,9	2.40	32,0	1.26	2 1/4	1 13/16
FC5321-3232S	FC4014-3232S	FC2717-32S	2 1/2 - 12	-32	135,6	5.34	58,6	2.31	42,9	1.69	2 7/8	
SAE 37° (JIC) male flare												
FC5323-1212S	FC2697-1212S	FC2717-12S	1 1/16 - 12	-12	94,7	3.73	41,1	1.62	15,5	.61		1 1/8
FC5323-1616S	FC2697-1616S	FC2540-16S	1 5/16 - 12	-16	110,7	4.36	44,5	1.75	19,8	.78		1 3/8
FC5323-2020S	FC2697-2020S	FC2717-20S	1 5/8 - 12	-20	112,7	4.44	45,7	1.80	26,7	1.05		1 5/8
FC5323-2424S	FC2697-2424S	FC2717-24S	1 7/8 - 12	-24	129,3	5.09	51,8	2.04	32,0	1.26		1 7/8

*Internal skive crimp fittings cannot be crimped on FT1244 machines, except as follows: FC5258-0608S, FC5258-0808S, and FC5014-0808S fittings can be crimped on FT1244 machines by using special equipment and procedures.

SPECIALTY & TRUCK HOSE

LOW & MEDIUM PRESSURE HOSE

HIGH PRESSURE HOSE

HOSE FITTINGS

ADAPTERS & TUBE FITTINGS

ACCESSORIES & ASSEMBLY INSTRUCTIONS

HOSE ASSEMBLY EQUIPMENT

APPENDICES

Internal Skive Crimp Fittings*

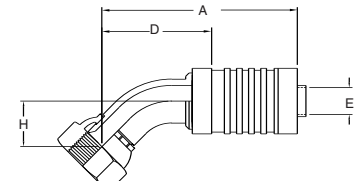
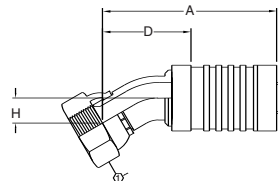
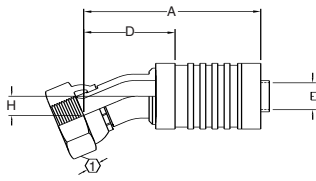

For use with Hose:

FC273, FC325

SAE 37° (JIC) 22¹/₂° Elbow
FJ9035

SAE 37° (JIC) 30° Elbow
FJ9036

SAE 37° (JIC) 45° Elbow
FC5560

Complete Fitting Part #	Component Part Numbers		Thd.	Hose Size	A		D		EØ		H		I
	Nipple Assy. Part #	Socket Part #			mm	in	mm	in	mm	in	mm	in	
22¹/₂° Elbow													
FJ9035-1212S	FJ8029-1212S	FC2717-12S	1 ¹ / ₁₆ -12	-12	114,0	4.49	60,2	2.37	15,5	.61	13,2	.52	1 ¹ / ₄
FJ9035-1616S	FJ8029-1616S	FC2540-16S	1 ⁵ / ₁₆ -12	-16	145,0	5.71	78,7	3.10	19,8	.78	17,5	.69	1 ¹ / ₂
FJ9035-2020S	FJ8029-2020S	FC2717-20S	1 ⁵ / ₈ -12	-20	156,2	6.15	88,9	3.50	26,7	1.05	20,3	.80	2
FJ9035-2424S	FJ8029-2424S	FC2717-24S	1 ⁷ / ₈ -12	-24	185,7	7.31	108,2	4.26	32,0	1.26	24,1	.95	2 ¹ / ₄
37° Elbow													
FJ9036-1212S	FC4571-1212S	FC2717-12S	1 ¹ / ₁₆ -12	-12	114,3	4.50	58,6	2.31	15,5	.61	17,5	.69	1 ¹ / ₄
FJ9036-1616S	FC4571-1616S	FC2540-16S	1 ⁵ / ₁₆ -12	-16	146,8	5.78	80,2	3.16	19,8	.78	24,1	.95	1 ¹ / ₂
FJ9036-2020S	FC4571-2020S	FC2717-20S	1 ⁵ / ₈ -12	-20	159,5	6.28	92,2	3.63	26,7	1.05	28,2	1.11	2
FJ9036-2424S	FC4571-2424S	FC2717-24S	1 ⁷ / ₈ -12	-24	187,7	7.39	110,2	4.34	32,0	1.26	32,8	1.29	2 ¹ / ₄
45° Elbow													
FC5560-1212S	FC4562-1212S	FC2717-12S	1 ¹ / ₁₆ -12	-12	117,9	4.64	64,0	2.52	15,5	.61	29,5	1.16	1 ¹ / ₄
FC5560-1616S	FC4562-1616S	FC2540-16S	1 ⁵ / ₁₆ -12	-16	150,4	5.92	83,8	3.30	19,8	.78	38,9	1.53	1 ¹ / ₂
FC5560-2020S	FC4562-2020S	FC2717-20S	1 ⁵ / ₈ -12	-20	158,5	6.24	91,4	3.60	26,7	1.05	43,8	1.70	2
FC5560-2424S	FC4562-2424S	FC2717-24S	1 ⁷ / ₈ -12	-24	187,2	7.37	109,7	4.32	32,0	1.26	50,5	1.99	2 ¹ / ₄

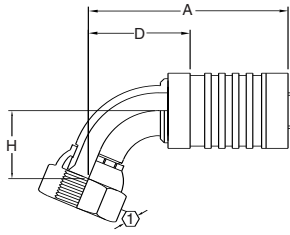

SAE 37° (JIC) 60° Elbow
FJ9037

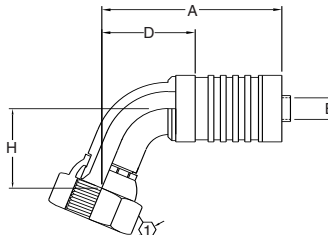

SAE 37° (JIC) 67¹/₂° Elbow
FJ9038

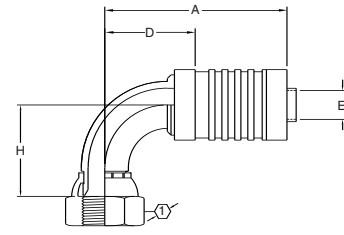

SAE 37° (JIC) 90° Elbow
FC5503

Complete Fitting Part #	Component Part Numbers		Thd.	Hose Size	A		D		EØ		H		I
	Nipple Assy. Part #	Socket Part #			mm	in	mm	in	mm	in	mm	in	
60° Elbow													
FJ9037-1212S	FJ8030-1212S	FC2717-12S	11/16-12	-12	117,3	4.62	63,8	2.51	15,5	.61	40,6	1.60	1 ¹ / ₄
FJ9037-1616S	FJ8030-1616S	FC2540-16S	15/16-12	-16	147,8	5.82	81,3	3.20	19,8	.78	52,8	2.08	1 ¹ / ₂
FJ9037-2020S	FJ8030-2020S	FC2717-20S	15/8-12	-20	157,0	6.18	89,9	3.54	26,7	1.05	59,2	2.33	2
FJ9037-2424S	FJ8030-2424S	FC2717-24S	17/8-12	-24	184,4	7.26	106,9	4.21	32,0	1.26	69,1	2.72	2
67¹/₂° Elbow													
FJ9038-1212S	FJ8031-1212S	FC2717-12S	11/16-12	-12	115,6	4.55	61,7	2.43	15,5	.61	45,7	1.80	1 ¹ / ₄
FJ9038-1616S	FJ8031-1616S	FC2540-16S	15/16-12	-16	146,3	5.76	79,7	3.14	19,8	.78	59,9	2.36	1 ¹ / ₂
FJ9038-2020S	FJ8031-2020S	FC2717-20S	15/8-12	-20	153,9	6.06	86,6	3.41	26,7	1.05	66,5	2.62	2
FJ9038-2424S	FJ8031-2424S	FC2717-24S	17/8-12	-24	169,9	6.69	92,5	3.64	32,0	1.26	70,1	2.76	2 ¹ / ₄
90° Elbow													
FC5503-1212S	FC4564-1212S	FC2717-12S	11/16-12	-12	106,7	4.20	52,8	2.08	15,5	.61	59,7	2.35	1 ¹ / ₄
FC5503-1616S	FC4564-1616S	FC2540-16S	15/16-12	-16	133,6	5.26	67,1	2.64	19,8	.78	77,2	3.04	1 ¹ / ₂
FC5503-2020S	FC4564-2020S	FC2717-20S	15/8-12	-20	140,7	5.54	73,7	2.90	26,7	1.05	86,4	3.40	2
FC5503-2424S	FC4564-2424S	FC2717-24S	17/8-12	-24	165,4	6.51	87,9	3.46	32,0	1.26	100,3	3.95	2 ¹ / ₄

*Internal skive crimp fittings cannot be crimped on FT1244 machines, except as follows: FC5258-0608s, FC5258-0808s and FC5014-0808s fittings can be crimped on FT1244 machines by using special equipment and procedures.

Internal Skive Crimp Fittings*

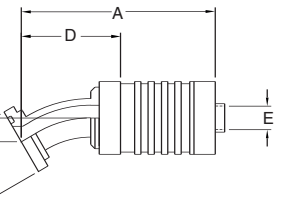
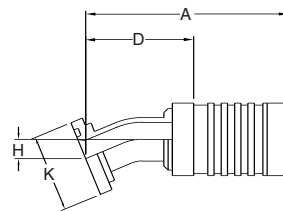
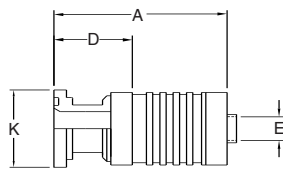

For use with Hose:

FC273, FC325

Straight Split Flange
FC5325 Code 62

22 1/2° Elbow Split Flange
FC5372 Code 62

30° Elbow Split Flange
FC5370 Code 62

Complete Fitting Part #	Component Part Numbers		Flange Head Dia. K Ø	Hose Size	A		D		EØ		H	
	Nipple Assy. Part #	Socket Part #			mm	in	mm	in	mm	in	mm	in
Straight split flange — Code 62 (SAE J518)												
FC5325-1212S	FC4049-1212S	FC2717-12S	41,1	1.62	-12	115,8	4.56	62,0	2.44	15,5	.61	
FC5325-1612S	FC4049-1612S	FC2717-12S	47,8	1.88	-12	115,8	4.56	62,0	2.44	15,5	.61	
FC5325-1616S	FC4049-1616S	FC2540-16S	47,8	1.88	-16	142,5	5.61	76,2	3.00	19,8	.78	
FC5325-2016S	FC4049-2016S	FC2540-16S	53,8	2.12	-16	142,5	5.61	76,2	3.00	19,8	.78	
FC5325-2020S	FC4049-2020S	FC2717-20S	53,8	2.12	-20	144,3	5.68	77,0	3.03	26,7	1.05	
FC5325-2420S	FC4049-2420S	FC2717-20S	63,5	2.50	-20	144,3	5.68	77,0	3.03	26,7	1.05	
FC5325-2424S	FC4049-2424S	FC2717-24S	63,5	2.50	-24	174,0	6.85	96,5	3.80	32,0	1.26	
FC5325-3224S	FC4049-3224S	FC2717-24S	79,2	3.12	-24	174,0	6.85	96,5	3.80	32,0	1.26	
FC5325-3232S	FC4049-3232S	FC2717-32S	79,2	3.12	-32	198,6	7.82	121,9	4.80	42,9	1.69	
22 1/2° Elbow split flange — Code 62 (SAE J518)												
FC5372-1212S	FC4374-1212S	FC2717-12S	41,1	1.62	-12	108,7	4.28	55,1	2.17	15,5	.61	11,2 .44
FC5372-1612S	FC4374-1612S	FC2717-12S	47,8	1.88	-12	108,7	4.28	55,1	2.17	15,5	.61	11,2 .44
FC5372-1616S	FC4374-1616S	FC2540-16S	47,8	1.88	-16	129,5	5.10	63,0	2.48	19,8	.78	11,2 .44
FC5372-2016S	FC4374-2016S	FC2540-16S	53,8	2.12	-16	129,5	5.10	63,0	2.48	19,8	.78	11,2 .44
FC5372-2020S	FC4374-2020S	FC2717-20S	53,8	2.12	-20	138,2	5.44	70,9	2.79	26,7	1.05	12,7 .50
FC5372-2420S	FC4374-2420S	FC2717-20S	63,5	2.50	-20	138,2	5.44	70,9	2.79	26,7	1.05	12,7 .50
FC5372-2424S	FC4374-2424S	FC2717-24S	63,5	2.50	-24	166,4	6.55	88,9	3.50	32,0	1.26	16,0 .63
FC5372-3224S	FC4374-3224S	FC2717-24S	79,2	3.12	-24	166,4	6.55	88,9	3.50	32,0	1.26	16,0 .63
FC5372-3232S	FC4374-3232S	FC2717-32S	79,2	3.12	-32	198,6	7.82	121,9	4.80	42,9	1.69	22,4 .88
30° Elbow split flange — Code 62 (SAE J518)												
FC5370-1212S	FC4387-1212S	FC2717-12S	41,1	1.62	-12	107,4	4.23	53,8	2.12	15,5	.61	14,7 .58
FC5370-1612S	FC4387-1612S	FC2717-12S	47,8	1.88	-12	107,4	4.23	53,8	2.12	15,5	.61	14,7 .58
FC5370-1616S	FC4387-1616S	FC2540-16S	47,8	1.88	-16	132,1	5.20	65,5	2.58	19,8	.78	15,7 .62
FC5370-2016S	FC4387-2016S	FC2540-16S	53,8	2.12	-16	132,1	5.20	65,5	2.58	19,8	.78	15,7 .62
FC5370-2020S	FC4387-2020S	FC2717-20S	53,8	2.12	-20	142,5	5.61	75,2	2.96	26,7	1.05	18,3 .72
FC5370-2420S	FC4387-2420S	FC2717-20S	63,5	2.50	-20	142,5	5.61	75,2	2.96	26,7	1.05	18,3 .72
FC5370-2424S	FC4387-2424S	FC2717-24S	63,5	2.50	-24	169,4	6.67	91,9	3.62	32,0	1.26	22,4 .88
FC5370-3224S	FC4387-3224S	FC2717-24S	79,2	3.12	-24	169,4	6.67	91,9	3.62	32,0	1.26	22,4 .88
FC5370-3232S	FC4387-3232S	FC2717-32S	79,2	3.12	-32	204,7	8.06	128,0	5.04	42,9	1.69	31,8 1.25

*Internal skive crimp fittings cannot be crimped on FT1244 machines, except as follows: FC5258-0608S, FC5258-0808S and FC5014-0808S fittings can be crimped on FT1244 machines by using special equipment and procedures.

NOTE: For flanges, split flange halves, kits and o-rings, see pages 190-195.

SPECIALTY & TRUCK HOSE

LOW & MEDIUM PRESSURE HOSE

HIGH PRESSURE HOSE

HOSE FITTINGS

ADAPTERS & TUBE FITTINGS

ACCESSORIES & ASSEMBLY INSTRUCTIONS

HOSE ASSEMBLY EQUIPMENT

APPENDICES

Internal Skive Crimp Fittings*

For use with Hose:

FC273, FC325

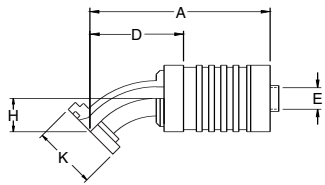

45° Elbow Split Flange

FC5327 Code 62

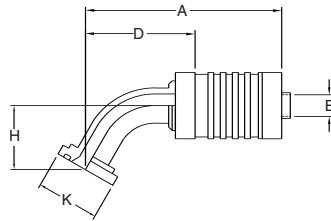

60° Elbow Split Flange

FJ9023 Code 62

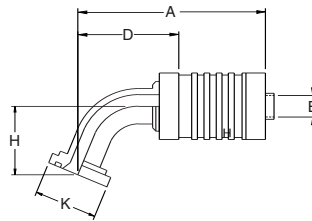

67 1/2° Elbow Split Flange

FC5371 Code 62

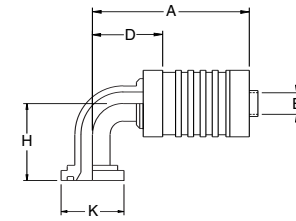

90° Elbow Split Flange

FC5329 Code 62

Complete Fitting Part #	Component Part Numbers		Flange Head Dia. K Ø	Hose Size	A		D		EØ		H		
	Nipple Assy. Part #	Socket Part #			mm	in	mm	in	mm	in	mm	in	
45° Elbow split flange — Code 62 (SAE J518)													
FC5327-1212S	FC4049-1212S	FC2717-12S	41,1	1.62	-12	113,8	4.48	60,2	2.37	15,5	.61	25,4	1.00
FC5327-1612S	FC4049-1612S	FC2717-12S	47,8	1.88	-12	113,8	4.48	60,2	2.37	15,5	.61	25,4	1.00
FC5327-1616S	FC4049-1616S	FC2540-16S	47,8	1.88	-16	138,2	5.44	71,9	2.83	19,8	.78	26,9	1.06
FC5327-2016S	FC4049-2016S	FC2540-16S	53,8	2.12	-16	138,2	5.44	71,9	2.83	19,8	.78	26,9	1.06
FC5327-2020S	FC4049-2020S	FC2717-20S	53,8	2.12	-20	144,8	5.70	77,5	3.05	26,7	1.05	29,2	1.15
FC5327-2420S	FC4049-2420S	FC2717-20S	63,5	2.50	-20	144,8	5.70	77,5	3.05	26,7	1.05	29,2	1.15
FC5327-2424S	FC4049-2424S	FC2717-24S	63,5	2.50	-24	172,5	6.79	95,0	3.74	32,0	1.26	35,6	1.40
FC5327-3224S	FC4049-3224S	FC2717-24S	79,2	3.12	-24	170,2	6.70	92,7	3.65	32,0	1.26	35,8	1.41
FC5325-3232S	FC4049-3232S	FC2717-32S	79,2	3.12	-32	209,0	8.23	132,1	5.20	42,9	1.69	50,8	2.00
60° Elbow split flange — Code 62 (SAE J518)													
FJ9023-1212S	FC4582-1212S	FC2717-12S	41,1	1.62	-12	114,6	4.51	60,9	2.40	15,5	.61	35,8	1.41
FJ9023-1612S	FC4582-1612S	FC2717-12S	47,8	1.88	-12	114,6	4.51	60,9	2.40	15,5	.61	35,8	1.41
FJ9023-1616S	FC4582-1616S	FC2540-16S	47,8	1.88	-16	139,2	5.48	72,9	2.87	19,8	.78	38,1	1.50
FJ9023-2016S	FC4582-2016S	FC2540-16S	53,8	2.12	-16	139,2	5.48	72,9	2.87	19,8	.78	38,1	1.50
FJ9023-2020S	FC4582-2020S	FC2717-20S	53,8	2.12	-20	147,3	5.80	80,0	3.15	26,7	1.05	42,2	1.66
FJ9023-2420S	FC4582-2420S	FC2717-20S	63,5	2.50	-20	147,3	5.80	80,0	3.15	26,7	1.05	42,2	1.66
FJ9023-2424S	FC4582-2424S	FC2717-24S	63,5	2.50	-24	174,0	6.85	96,5	3.80	32,0	1.26	50,8	2.00
FJ9023-3224S	FC4582-3224S	FC2717-24S	79,2	3.12	-24	174,0	6.85	96,5	3.80	32,0	1.26	50,8	2.00
FJ9023-3232S	FC4582-3232S	FC2717-32S	79,2	3.12	-32	212,9	8.38	136,1	5.36	42,9	1.69	73,2	2.88
67 1/2° Elbow split flange — Code 62 (SAE J518)													
FC5371-1212S	FC4373-1212S	FC2717-12S	41,1	1.62	-12	113,3	4.46	59,7	2.35	15,5	.61	40,6	1.60
FC5371-1612S	FC4373-1612S	FC2717-12S	47,8	1.88	-12	113,3	4.46	59,7	2.35	15,5	.61	40,6	1.60
FC5371-1616S	FC4373-1616S	FC2540-16S	47,8	1.88	-16	139,7	5.50	73,4	2.89	19,8	.78	44,5	1.75
FC5371-2016S	FC4373-2016S	FC2540-16S	53,8	2.12	-16	139,7	5.50	73,4	2.89	19,8	.78	44,5	1.75
FC5371-2020S	FC4373-2020S	FC2717-20S	53,8	2.12	-20	146,3	5.76	79,2	3.12	26,7	1.05	48,3	1.90
FC5371-2420S	FC4373-2420S	FC2717-20S	63,5	2.50	-20	146,3	5.76	79,2	3.12	26,7	1.05	48,3	1.90
FC5371-2424S	FC4373-2424S	FC2717-24S	63,5	2.50	-24	162,1	6.38	84,6	3.33	32,0	1.26	50,8	2.00
FC5371-3224S	FC4373-3224S	FC2717-24S	79,2	3.12	-24	162,1	6.38	84,6	3.33	32,0	1.26	50,8	2.00
FC5371-3232S	FC4373-3232S	FC2717-32S	79,2	3.12	-32	210,1	8.27	133,1	5.24	42,9	1.69	82,6	3.25
90° Elbow split flange — Code 62 (SAE J518)													
FC5329-1212S	FC4053-1212S	FC2717-12S	41,1	1.62	-12	106,7	4.20	52,8	2.08	15,5	.61	54,1	2.13
FC5329-1612S	FC4053-1612S	FC2717-12S	47,8	1.88	-12	106,7	4.20	52,8	2.08	15,5	.61	54,1	2.13
FC5329-1616S	FC4053-1616S	FC2540-16S	47,8	1.88	-16	133,6	5.26	67,1	2.64	19,8	.78	60,5	2.38
FC5329-2016S	FC4053-2016S	FC2540-16S	53,8	2.12	-16	133,6	5.26	67,1	2.64	19,8	.78	60,5	2.38
FC5329-2020S	FC4053-2020S	FC2717-20S	53,8	2.12	-20	140,7	5.54	73,7	2.90	26,7	1.05	66,5	2.62
FC5329-2420S	FC4053-2420S	FC2717-20S	63,5	2.50	-20	140,7	5.54	73,7	2.90	26,7	1.05	66,5	2.62
FC5329-2424S	FC4053-2424S	FC2717-24S	63,5	2.50	-24	165,4	6.51	87,9	3.46	32,0	1.26	79,2	3.12
FC5329-3224S	FC4053-3224S	FC2717-24S	79,2	3.12	-24	165,4	6.51	87,9	3.46	32,0	1.26	79,2	3.12
FC5329-3232S	FC4053-3232S	FC2717-32S	79,2	3.12	-32	200,7	7.90	124,0	4.88	42,9	1.69	114,3	4.50

*Internal skive crimp fittings cannot be crimped on FT1244 machines, except as follows: FC5258-0608S, FC5258-0808S and FC5014-0808S fittings can be crimped on FT1244 machines by using special equipment and procedures.

NOTE: For flanges, split flange halves, kits and o-rings, see pages 190-195.

Internal Skive Crimp Fittings*

For use with Hose:

FC273, FC325

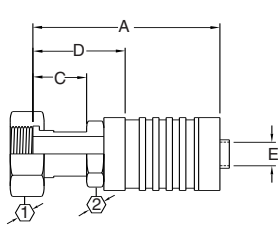

ORS Swivel Straight

FJ9718

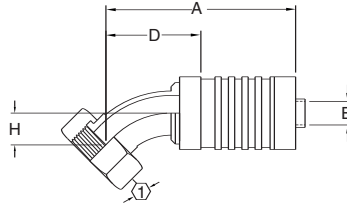

ORS Swivel 45° Elbow

FJ9719

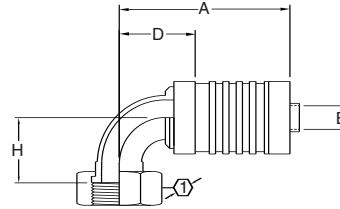

ORS Swivel 90° Elbow (short)

FJ9720

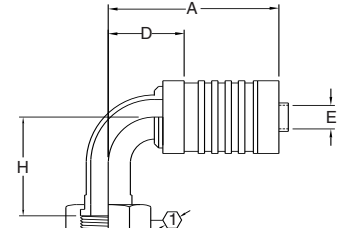

ORS Swivel 90° Elbow (long)

FJ9721

Complete Fitting Part #	Component Part Numbers		Thd.	Hose Size	A		C		D		EØ		H	①	②
	Nipple Assy. Part #	Socket Part #			mm	in	mm	in	mm	in	mm	in			
Straight															
FJ9718-1212S	FJ8608-1212S	FC2717-12S	1 ³ / ₁₆ -12	-12	97,0	3.82	27,2	1.07	43,8	1.70	15,5	.61		1 ³ / ₈	1 ¹ / ₈
FJ9718-1616S	FJ8608-1616S	FC2540-16S	1 ⁷ / ₁₆ -12	-16	117,9	4.64	29,0	1.14	51,6	2.03	19,8	.78		1 ⁵ / ₈	1 ³ / ₈
FJ9718-2020S	FJ8608-2020S	FC2717-20S	1 ¹¹ / ₁₆ -12	-20	118,9	4.68	28,7	1.13	51,6	2.03	26,7	1.05		2 ⁷ / ₈	1 ⁵ / ₈
FJ9718-2424S	FJ8608-2424S	FC2717-24S	2 -12	-24	130,6	5.14	25,4	1.00	53,1	2.09	32,0	1.26		2 ¹ / ₄	2
45° Elbow															
FJ9719-1212S	FJ8611-1212S	FC2717-12S	1 ³ / ₁₆ -12	-12	109,2	4.30			55,6	2.19	14,2	.56	21,1	.83	1 ³ / ₈
FJ9719-1616S	FJ8611-1616S	FC2540-16S	1 ⁷ / ₁₆ -12	-16	138,4	5.45			72,1	2.84	19,3	.76	22,9	.90	1 ⁵ / ₈
FJ9719-2020S	FJ8611-2020S	FC2717-20S	1 ¹¹ / ₁₆ -12	-20	137,2	5.40			69,9	2.75	25,7	1.01	25,4	1.00	2 ⁷ / ₈
FJ9719-2424S	FJ8611-2424S	FC2717-24S	2 -12	-24	162,8	6.41			85,3	3.36	30,2	1.19	25,4	1.00	2 ¹ / ₄
90° Elbow (short)															
FJ9720-1212S	FJ8614-1212S	FC2717-12S	1 ³ / ₁₆ -12	-12	106,7	4.20			52,8	2.08	14,2	.56	47,8	1.88	1 ³ / ₈
FJ9720-1616S	FJ8614-1616S	FC2540-16S	1 ⁷ / ₁₆ -12	-16	131,1	5.16			64,5	2.54	19,3	.76	56,1	2.21	1 ⁵ / ₈
FJ9720-2020S	FJ8614-2020S	FC2717-20S	1 ¹¹ / ₁₆ -12	-20	139,2	5.48			72,1	2.84	25,7	1.01	63,8	2.51	2 ⁷ / ₈
FJ9720-2424S	FJ8614-2424S	FC2717-24S	2 -12	-24	165,4	6.51			87,9	3.46	30,2	1.19	68,6	2.70	2 ¹ / ₄
90° Elbow (long)															
FJ9721-1212S	FJ8717-1212S	FC2717-12S	1 ³ / ₁₆ -12	-12	106,7	4.20			52,8	2.08	14,2	.56	96,0	3.78	1 ³ / ₈
FJ9721-1616S	FJ8717-1616S	FC2540-16S	1 ⁷ / ₁₆ -12	-16	133,6	5.26			67,1	2.64	19,3	.76	114,3	4.50	1 ⁵ / ₈
FJ9721-2020S	FJ8717-2020S	FC2717-20S	1 ¹¹ / ₁₆ -12	-20	140,7	5.54			73,7	2.90	25,7	1.01	129,3	5.09	1 ⁷ / ₈
FJ9721-2424S	FJ8717-2424S	FC2717-24S	2 -12	-24	165,4	6.51			87,9	3.46	30,2	1.19	140,7	5.54	2 ¹ / ₄

SPECIALTY &
TRUCK HOSE

LOW & MEDIUM
PRESSURE HOSE

HIGH PRESSURE HOSE

HOSE FITTINGS

ADAPTERS &
TUBE FITTINGS

ACCESSORIES &
ASSEMBLY INSTRUCTIONS

HOSE ASSEMBLY
EQUIPMENT

APPENDICES

Internal Skive Crimp Fittings*

For use with Hose:

FC606

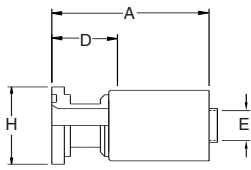

Straight Split Flange
FJ7261 Code 62

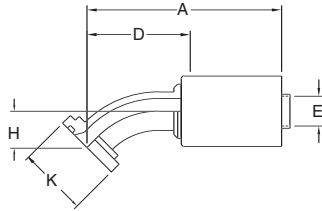

45° Elbow Split Flange
FJ7274 Code 62

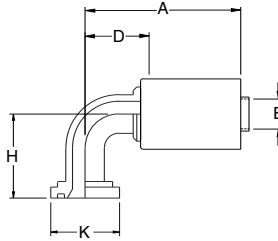

90° Elbow Split Flange
FJ7277 Code 62

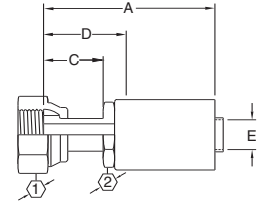

ORS Straight
FJ7260

Complete Fitting Part #	Component Part Numbers		Flange Head Dia. K Ø Thd.	Hose Size	A		C		D		EØ		H		①	②
	Nipple Assy. Part #	Socket Part #			mm	in	mm	in	mm	in	mm	in	mm	in		
Straight split flange — Code 62 (SAE) J518																
FJ7261-1616S	FJ8608-1616S	FC1601-16S	47,8 1.88	-16	143,8	5.66			76,7	3.02	19,3	.76				
FJ7261-1620S	FJ8608-1620S	FC1601-20S	47,8 1.88	-20	156,2	6.15			76,7	3.02	19,3	.76				
FJ7261-2020S	FJ8608-2020S	FC1601-20S	53,8 2.12	-20	157,0	6.18			76,7	3.02	23,9	.94				
45° Elbow split flange — Code 62 (SAE) J518																
FJ7274-1616S	FJ6274-1616S	FC1601-16S	47,8 1.88	-16	139,7	5.50			65,0	2.56	19,3	.76	26,9	1.06		
FJ7274-2020S	FJ6274-2020S	FC1601-20S	53,8 2.12	-20	157,5	6.20			79,0	3.11	23,9	.94	29,2	1.15		
90° Elbow split flange — Code 62 (SAE) J518																
FJ7277-1616S	FJ6277-1616S	FC1601-16S	47,8 1.88	-16	134,9	5.31			67,8	2.67	19,3	.76	60,5	2.38		
FJ7277-2020S	FJ6277-2020S	FC1601-20S	53,8 2.12	-20	153,7	6.05			75,2	2.96	23,9	.94	66,5	2.62		
ORS straight																
FJ7260-1616S	FJ6260-1616S	FC1601-16S	1 7/16 - 12	-16	110,0	4.33	29,0	1.14	42,9	1.69	19,8	.78			1 5/8	1 3/8

*Internal skive crimp fittings cannot be crimped on FT1244 machines, except as follows: FC5258-0608S, FC5258-0808S and FC5014-0808S fittings can be crimped on FT1244 machines by using special equipment and procedures.

NOTE: For flanges, split flange halves, kits and o-rings, see pages 190-195.

PTFE Crimp Fittings

For use with Hose:

2807, FC465, FC807

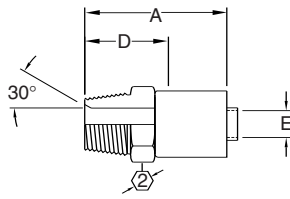

Male Pipe
FC9846

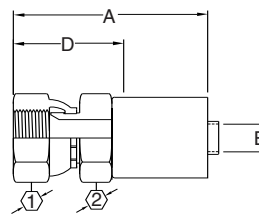

SAE 37° (JIC) swivel
FC9779

Complete Fitting Part #	Component Part Numbers		Thd.	Hose Size	A		D		EØ		①	②
	Nipple Assy. Part #	Socket Part #			mm	in	mm	in	mm	in		
Male pipe												
FC9846-0204S*	FC3680-0204S**	FC3596-04S	1/8-27	-04	31,8	1.25	16,8	.66	3,0	.12		7/16
FC9846-0404S*	FC3680-0404S**	FC3596-04S	1/4-18	-04	38,1	1.50	23,1	.91	3,0	.12		9/16
FC9846-0405S*	FC3680-0405S**	FC3443-04S	1/4-18	-05	35,6	1.40	23,1	.91	4,8	.19		9/16
FC9846-0406S*	FC3680-0406S**	FC3443-05S	1/4-18	-06	35,6	1.40	23,1	.91	6,4	.25		9/16
FC9846-0606S*	FC3680-0606S**	FC3443-05S	3/8-18	-06	35,6	1.40	23,1	.91	6,4	.25		11/16
FC9846-0608S*	FC3680-0608S**	FC3596-08S	3/8-18	-08	45,7	1.80	23,1	.91	8,6	.34		11/16
FC9846-0808S*	FC3680-0808S**	FC3596-08S	1/2-14	-08	51,8	2.04	29,5	1.16	8,6	.34		7/8
FC9846-0810S*	FC3680-0810S**	FC3443-08S	1/2-14	-10	51,8	2.04	29,5	1.16	11,2	.44		7/8
FC9846-1212S*	FC3680-1212S**	FC3596-12S	3/4-14	-12	51,8	2.04	29,5	1.16	14,2	.56		1 1/16
FC9846-1616S*	FC3680-1616S**	FC3596-16S	1-11 1/2	-16	58,9	2.32	36,6	1.44	20,3	.80		1 3/8
Male pipe – stainless steel												
FC9846-0204-333	FC3680-0204-329	FC3596-04C	1/8-27	-04	31,8	1.25	16,8	.66	3,0	.12		7/16
FC9846-0404-333	FC3680-0404-329	FC3596-04C	1/4-18	-04	38,1	1.50	23,1	.91	3,0	.12		9/16
FC9846-0405-333	FC3680-0405-329	FC3443-04C	1/4-18	-05	35,6	1.40	23,1	.91	4,8	.19		9/16
FC9846-0406-333	FC3680-0406-329	FC3443-05C	1/4-18	-06	35,6	1.40	23,1	.91	6,4	.25		9/16
FC9846-0606-333	FC3680-0606-329	FC3443-05C	3/8-18	-06	35,6	1.40	23,1	.91	6,4	.25		11/16
FC9846-0608-333	FC3680-0608-329	FC3596-08C	3/8-18	-08	45,7	1.80	23,1	.91	8,6	.34		11/16
FC9846-0810-333	FC3680-0810-329	FC3443-08C	1 1/2-14	-10	51,8	2.04	29,5	1.16	11,2	.44		7/8
FC9846-1212-333	FC3680-1212-329	FC3596-12C	3/4-14	-12	51,8	2.04	29,5	1.16	14,2	.56		1 1/16
FC9846-1616-333	FC3680-1616-329	FC3596-16C	1-11 1/2	-16	58,9	2.32	36,6	1.44	20,3	.80		1 3/8
SAE 37° (JIC) swivel												
FC9779-0404S†	FC8779-0404S†	FC3596-04S	7/16-20	-04	39,4	1.55	24,4	.96	3,0	.12	9/16	7/16
FC9779-0505S†	FC8779-0505S†	FC3443-04S	1 1/2-20	-05	38,1	1.50	25,7	1.01	4,8	.19	5/8	1/2
FC9779-0606S†	FC8779-0606S†	FC3443-05S	9/16-18	-06	40,6	1.60	28,2	1.11	6,4	.25	11/16	9/16
FC9779-0808S†	FC8779-0808S†	FC3596-08S	3/4-16	-08	53,3	2.10	30,7	1.21	8,6	.34	7/8	11/16
FC9779-1010S†	FC8779-1010S†	FC3443-08S	7/8-14	-10	56,1	2.21	33,5	1.32	11,2	.44	1	13/16
FC9779-1212S†	FC8779-1212S†	FC3596-12S	1 1/16-12	-12	58,2	2.29	35,8	1.41	14,2	.56	1 1/4	1
FC9779-1616S†	FC8779-1616S†	FC3596-16S	1 5/16-12	-16	64,0	2.52	41,7	1.64	20,3	.80	1 1/2	1 1/4
SAE 37° (JIC) swivel – stainless steel												
FC9779-0404-333	FC8779-0404-333	FC3596-04C	7/16-20	-04	39,4	1.55	24,4	.96	3,0	.12	9/16	7/16
FC9779-0505-333	FC8779-0505-333	FC3443-04C	1 1/2-20	-05	38,1	1.50	25,7	1.01	4,8	.19	5/8	1/2
FC9779-0606-333	FC8779-0606-333	FC3443-05C	9/16-18	-06	40,6	1.60	28,2	1.11	6,4	.25	11/16	9/16
FC9779-0808-333	FC8779-0808-333	FC3596-08C	3/4-16	-08	53,3	2.10	30,7	1.21	8,6	.34	7/8	11/16
FC9779-1010-333	FC8779-1010-333	FC3443-08C	7/8-14	-10	56,1	2.21	33,5	1.32	11,2	.44	1	13/16
FC9779-1212-333	FC8779-1212-333	FC3596-12C	1 5/16-12	-12	58,2	2.29	35,8	1.41	14,2	.56	1 1/4	1
FC9779-1616-333	FC8779-1616-333	FC3596-16C	1 5/16-12	-16	64,0	2.52	41,7	1.64	20,3	.80	1 1/2	1 1/4

* For brass drop "S" suffix, replace with -38.

**For brass drop "S" suffix, replace with "B".

† For brass drop "S" suffix, replace with -63.

SPECIALTY & TRUCK HOSE

LOW & MEDIUM PRESSURE HOSE

HIGH PRESSURE HOSE

HOSE FITTINGS

ADAPTERS & TUBE FITTINGS

ACCESSORIES & ASSEMBLY INSTRUCTIONS

HOSE ASSEMBLY EQUIPMENT

APPENDICES

PTFE Crimp Fittings

For use with Hose:

2807, FC465, FC807

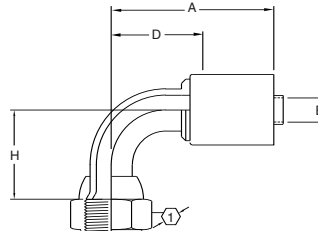
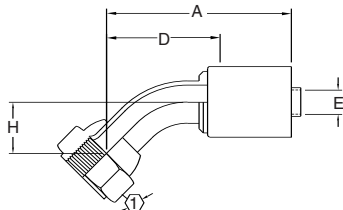
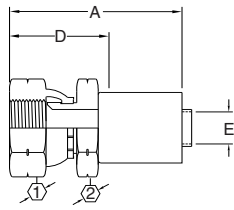

SAE 45° Swivel
FC7216

45° Elbow Universal
FC7220

90° Elbow
FC5098 Universal
FC7217 SAE 45°

Complete Fitting Part #	Component Part Numbers		Thd.	Hose Size	A		D		EØ		H		1	2
	Nipple Assy. Part #	Socket Part #			mm	in	mm	in	mm	in	mm	in		
SAE 45° swivel														
FC7216-0404S	FC6216-0404S†	FC3596-04S	1 ⁷ / ₁₆ -20	-04	39,4	1.55	24,4	.96	3,0	.12			9/16	7/16
FC7216-0505S	FC6216-0505S†	FC3443-04S	1 ⁷ / ₁₆ -20	-05	38,1	1.50	25,7	1.01	4,8	.19			5/8	1/2
FC7216-0606S	FC6216-0606S†	FC3443-05S	5/8-18	-06	41,4	1.63	29,0	1.14	6,4	.25			3/4	9/16
FC7216-0808S	FC6216-0808S†	FC3596-08S	3/4-16	-08	53,3	2.10	30,7	1.21	8,6	.34			7/8	1 ¹ / ₁₆
FC7216-1010S	FC6216-1010S†	FC3443-08S	7/8-14	-10	56,1	2.21	33,5	1.32	11,2	.44			1	1 ³ / ₁₆
FC7216-1212S	FC6216-1212S†	FC3596-12S	1 ¹ / ₁₆ -14	-12	58,2	2.29	35,8	1.41	14,2	.56			1 ¹ / ₄	1
45° Elbow														
FC7220-0808S	FC6220-0808S	FC3596-08S	3/4-16	-08	54,9	2.16	32,3	1.27	9,1	.36	14,0	.55	7/8	
90° Elbow														
FC5098-0404S	FC4098-0404S	FC3596-04S	1 ⁷ / ₁₆ -20	-04	32,5	1.28	17,5	.69	3,0	.12	17,3	.68	9/16	
FC7217-0606S	FC6217-0606S	FC3443-05S	5/8-18	-06	33,3	1.31	20,8	.82	6,4	.25	21,6	.85	3/4	

*Available with brass nipples, contact Eaton.

† For brass drop "S" suffix, replace with -63.

SPECIALTY & TRUCK HOSE
 LOW & MEDIUM PRESSURE HOSE
 HIGH PRESSURE HOSE
 HOSE FITTINGS
 ADAPTERS & TUBE FITTINGS
 ACCESSORIES & ASSEMBLY INSTRUCTIONS
 HOSE ASSEMBLY EQUIPMENT
 APPENDICES

PTFE Crimp Fittings

For use with Hose:

FC363, FC364
FC563 - Factory Crimp

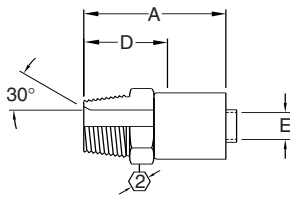

Male Pipe
FJ9588

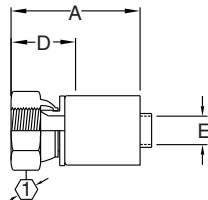

SAE 37° (JIC) Swivel
FJ9587

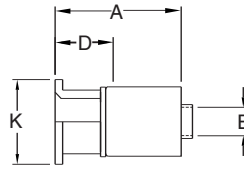

Flange Retainer
FJ9656

Complete Fitting No. Stain Stl.	Component Part Numbers		Thd.	Hose Size	A		D		EØ		KØ		①	②
	Nipple Assy. Stain Stl.	Socket Stain Stl.			mm	in	mm	in	mm	in	mm	in		
Male pipe stainless steel														
FJ9588-0808-341	FC1349-0808-259	FC1347-08-329	1/2-14	-08	64,5	2.54	33,0	1.30	10,4	.41				7/8
FJ9588-1212-341	FC1349-1212-259	FC1347-12-329	3/4-14	-12	66,3	2.61	34,8	1.37	15,5	.61				1 1/8
FJ9588-1616-341	FC1349-1616-259	FC1347-16-329	1-11 1/2	-16	71,1	2.80	39,4	1.55	20,6	.81				1 3/8
FJ9588-2020-341	FC1349-2020-259	FC1347-20-329	1 1/4-11 1/2	-20	74,9	2.95	43,2	1.70	26,7	1.05				1 3/4
FJ9588-2424-341	FC1349-2424-259	FC1347-24-329	1 1/2-11 1/2	-24	81,3	3.20	44,2	1.74	32,5	1.28				2
FJ9588-3232-341	FC1349-3232-259	FC1347-32-329	2-11 1/2	-32	87,9	3.46	49,8	1.96	44,5	1.75				2 1/2
SAE 37° (JIC) swivel stainless steel														
FJ9587-0808-331	FJ8587-0808-331	FC1347-08-329	3/4-16	-08	64,0	2.52	27,9	1.10	9,7	.38				7/8
FJ9587-1212-331	FJ8587-1212-331	FC1347-12-329	1 1/16-12	-12	64,8	2.55	31,2	1.23	15,5	.61				1 1/4
FJ9587-1616-331	FJ8587-1616-331	FC1347-16-329	1 5/16-12	-16	68,3	2.69	34,8	1.37	20,6	.81				1 1/2
FJ9587-2020-331	FJ8587-2020-331	FC1347-20-329	1 5/8-12	-20	72,1	2.84	38,6	1.52	26,7	1.05				2
FJ9587-2424-331	FJ8587-2424-331	FC1347-24-329	1 7/8-12	-24	81,5	3.21	42,4	1.67	32,5	1.28				2 1/4
FJ9587-3232-331	FJ8587-3232-331	FC1347-32-329	2 1/2-12	-32	88,9	3.50	48,8	1.92	44,5	1.75				2 7/8
Flange retainer stainless steel														
FJ9656-0808-331	FC1373-0808-259	FC1347-08-329		-08	65,0	2.56	31,5	1.24	10,4	.41	35,1	1.38		
FJ9656-1212-331	FC1373-1212-259	FC1347-12-329		-12	65,0	2.56	31,5	1.24	15,5	.61	42,9	1.69		
FJ9656-1616-331	FC1373-1616-259	FC1347-16-329		-16	66,5	2.62	33,0	1.30	20,6	.81	50,8	2.00		
FJ9656-2020-331	FC1373-2020-259	FC1347-20-329		-20	66,5	2.62	33,0	1.30	26,7	1.05	63,5	2.50		
FJ9656-2424-331	FC1373-2424-259	FC1347-24-329		-24	76,5	3.01	37,6	1.48	32,5	1.28	72,9	2.87		
FJ9656-3232-331	FC1373-3232-259	FC1347-32-329		-32	77,5	3.05	37,6	1.48	44,5	1.75	91,9	3.62		

SPECIALTY & TRUCK HOSE

LOW & MEDIUM PRESSURE HOSE

HIGH PRESSURE HOSE

HOSE FITTINGS

ADAPTERS & TUBE FITTINGS

ACCESSORIES & ASSEMBLY INSTRUCTIONS

HOSE ASSEMBLY EQUIPMENT

APPENDICES

PTFE Crimp Fittings

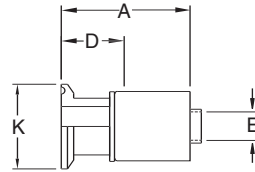
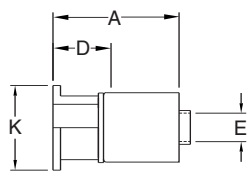

For use with Hose:

FC363, FC364
FC563 - Factory Crimp

Flange Retainer with PTFE Coated Nipple
FJ9656

Ladish Tri-Clamp*
FJ7041

Complete Fitting No. Stain Stl.	Component Part Numbers		Thd.	Hose Size	A		D		EØ		KØ	
	Nipple Assy. Stain Stl.	Socket Stain Stl.			mm	in	mm	in	mm	in	mm	in
Flange retainer with PTFE coated nipple												
FJ9656-0808-338	FC1373-0808-337	FC1347-08-329		-08	65,0	2.56	31,5	1.24	10,4	.41	35,1	1.38
FJ9656-1212-338	FC1373-1212-337	FC1347-12-329		-12	65,0	2.56	31,5	1.24	15,5	.61	42,9	1.69
FJ9656-1616-338	FC1373-1616-337	FC1347-16-329		-16	66,5	2.62	33,0	1.30	20,6	.81	50,8	2.00
FJ9656-2020-338	FC1373-2020-337	FC1347-20-329		-20	66,5	2.62	33,0	1.30	26,7	1.05	63,5	2.50
FJ9656-2424-338	FC1373-2424-337	FC1347-24-329		-24	76,5	3.01	37,6	1.48	32,5	1.28	72,9	2.87
FJ9656-3232-338	FC1373-3232-337	FC1347-32-329		-32	77,5	3.05	37,6	1.48	44,5	1.75	91,9	3.62
Ladish Tri-Clamp												
FJ7041-2416-331	FC1531-2416-259	FC1347-16-329		-16	50,3	1.98	19,3	.76	20,6	.81	50,3	1.98
FJ7041-2424-331	FC1531-2424-259	FC1347-24-329		-24	56,9	2.24	19,3	.76	32,3	1.27	50,3	1.98
FJ7041-3232-331	FC1531-3232-259	FC1347-32-329		-32	56,9	2.24	19,3	.76	44,5	1.75	63,8	2.51

*Tri-Clamp is a registered trademark of Tri-Clover, Inc.

Flange FC1389

For use with Hose: FC363, FC364

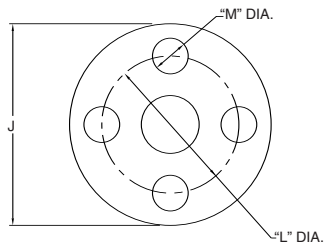

Part No. Stainless Steel	Hose size	Number Bolt Holes	J		L		M	
			mm	in	mm	in	mm	in
Flange								
FC1389-0808C	-08	4	88,9	3.50	60,5	2.38	15,7	.62
FC1389-1212C	-12	4	98,6	3.88	69,9	2.75	15,7	.62
FC1389-1616C	-16	4	108,0	4.25	79,2	3.12	15,7	.62
FC1389-2020C	-20	4	117,3	4.62	88,9	3.50	15,7	.62
FC1389-2424C	-24	4	127,0	5.00	98,6	3.88	15,7	.62
FC1389-3232C	-32	4	152,4	6.00	120,7	4.75	19,1	.75

Suction Hose Fittings

For use with Hose:

2661, FC619

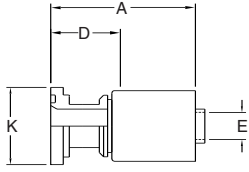

Straight Split Flange

FC9153 Code 61

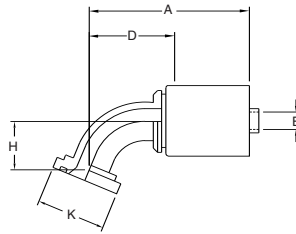

45° Elbow Split Flange

FC9155 Code 61

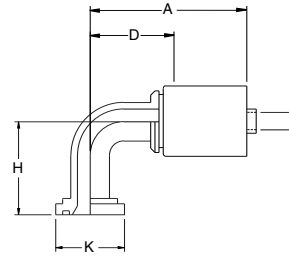

90° Elbow Split Flange

FC9152 Code 61

Complete Fitting Part #	Component Part Numbers		Flange Head Dia. KØ	Hose Size	A		D		EØ		H	
	Nipple Assy. Part #	Socket Part #			mm	in	mm	in	mm	in	mm	in
Straight split flange—Code 61 (SAEJ518)												
FC9153-3240S	FC8153-3240S	FC3023-40S	71,4 2.81	-40	142,5	5.81	73,6	2.90	44,9	1.77		
FC9153-4040S	FC8153-4040S	FC3023-40S	84,1 3.31	-40	144,0	5.67	75,2	2.96	53,3	2.10		
FC9153-4848S	FC8153-4848S	FC3023-48S	101,6 4.00	-48	173,2	6.82	82,8	3.26	63,5	2.50		
45° Elbow split flange—Code 61 (SAEJ518)												
FC9155-4040S	FC8155-4040S	FC3023-40S	84,1 3.31	-40	175,0	6.89	106,2	4.18	53,3	2.10	42,2	1.66
90° Elbow split flange—Code 61 (SAEJ518)												
FC9152-3240S	FC8152-3240S	FC3023-40S	71,4 2.81	-40	154,4	6.08	123,7	4.87	44,9	1.77	82,5	3.25
FC9152-4040S	FC8152-4040S	FC3023-40S	84,1 3.31	-40	192,5	7.58	123,7	4.87	53,3	2.10	131,8	5.19

Note: These fittings require special tooling to assemble. Contact Eaton for information before ordering.

For flanges, split flange halves, kits and o-rings, see pages 190-195.

SPECIALTY & TRUCK HOSE

LOW & MEDIUM PRESSURE HOSE

HIGH PRESSURE HOSE

HOSE FITTINGS

ADAPTERS & TUBE FITTINGS

ACCESSORIES & ASSEMBLY INSTRUCTIONS

HOSE ASSEMBLY EQUIPMENT

APPENDICES

100R5 Crimp Fittings

ORS Swivel Straight

FJ3468-

For use with Hose:
1503, FC234, FC300, FC350, FC355

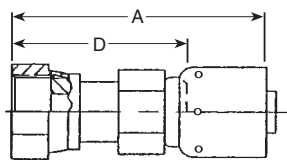

Complete Fitting Part #	Hose Size	A		D	
		mm	in	mm	in
FJ3468-					
0404S	-4	56,1	2.21	28,4	1.12
0606S	-6	67,2	2.64	37,0	1.45
0808S	-8	69,7	2.74	43,4	1.70
1010S	-10	78,2	3.08	50,8	2.00
1212S	-12	85,1	3.35	53,1	2.09
1616S	-16	92,0	3.62	59,7	2.35
2020S	-20	96,6	3.80	61,8	2.43
2424S	-24	104,1	4.11	64,5	2.52

ORS Swivel 45° Elbow

FJ3254-

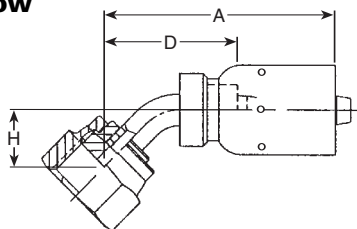

Complete Fitting Part #	Hose Size	A		D		H	
		mm	in	mm	in	mm	in
FJ3254-							
0404S	-4	64,8	2.55	40,9	1.61	9,9	.39
0606S	-6	72,1	2.84	30,5	1.77	10,9	.43
0808S	-8	78,6	3.09	39,4	1.97	15,0	.59
1010S	-10	78,5	3.09	52,0	2.05	16,0	.63
1212S	-12	96,0	3.78	63,9	2.51	21,1	.83
1616S	-16	78,5	4.02	69,8	2.74	24,1	.95

ORS Swivel 90° Elbow (Short)

FJ3255-

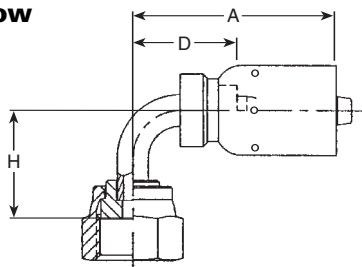

Complete Fitting Part #	Hose Size	A		D		H	
		mm	in	mm	in	mm	in
FJ3255-							
0404S	-4	60,7	2.39	36,8	1.45	21,1	.83
0606S	-6	89,6	2.74	42,4	1.67	23,1	.91
0808S	-8	72,9	2.87	46,5	1.83	29,0	1.14
1010S	-10	80,0	3.15	52,6	2.07	32,0	1.26
1212S	-12	93,5	3.68	61,5	2.42	48,0	1.89
1616S	-16	110,1	3.94	67,8	2.68	58,1	2.21
2020S	-20	92,8	3.65	82,9	2.47	63,4	2.50

SAE 37° (JIC) Swivel

FJ3114-

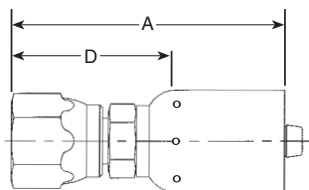

Complete Fitting Part #	Hose Size	A		D	
		mm	in	mm	in
FJ3114-					
0404S	-4	51,1	2.01	26,9	1.08
0405S	-5	48,1	1.89	28,1	1.10
0505S	-5	53,1	2.09	28,7	1.13
0606S	-6	57,4	2.28	30,0	1.18
0608S	-8	54,0	2.12	33,5	1.32
0806S	-6	61,2	2.41	33,5	1.32
0808S	-8	61,2	2.41	34,3	1.35
0810S	-10	64,5	2.64	36,8	1.45
1010S	-10	66,5	2.62	36,8	1.45
1212S	-12	70,4	2.77	38,1	1.50
1216S	-16	70,9	2.79	45,7	1.80
1616S	-16	79,0	3.11	43,4	1.71
2020S	-20	83,8	3.30	45,7	1.80
2020S	-20	83,2	3.28	45,5	1.79
2424S	-24	87,6	3.45	52,6	2.07
3232S ¹	-32	107,9	4.25	59,2	2.33

¹FJ3114-3232S is factory crimp only.

Straight SAE 45° Swivel

FJ3094-

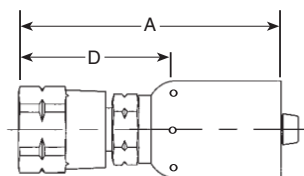

Complete Fitting Part #	Hose Size	A		D	
		mm	in	mm	in
FJ3094-					
0404S	-4	51,1	2.01	26,9	1.08
0405S	-5	48,0	1.89	27,9	1.10
0505S	-5	53,1	2.09	28,7	1.13
0606S	-6	55,6	2.19	27,9	1.10
0806S	-6	61,2	2.41	33,5	1.32
0808S	-8	61,2	2.41	34,3	1.35
0810S	-10	64,5	2.54	36,8	1.45
1010S	-10	66,5	2.62	36,8	1.45
1212S	-12	71,1	2.80	38,1	1.50

*Picture may not represent actual configuration.
Call Eaton Technical Assistance for details.

100R5 Crimp Fittings

For use with Hose:
1503, FC234, FC300, FC350, FC355

45° Elbow

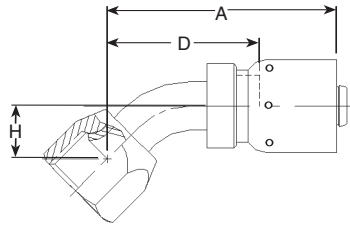

**FJ3243 -
Universal Swivel**

**FJ3246 -
SAE 45° Swivel**

**FJ3249 -
SAE 37° (JIC) Swivel**

Complete Fitting Part #	Hose Size	A		D		H	
		mm	in	mm	in	mm	in
FJ3243-							
0404S	-4	63,5	2.50	38,1	1.50	8,4	0.33
0505S‡	-5	66,8	2.63	41,4	1.63	9,1	0.36
0808S	-8	78,0	3.07	46,5	1.83	14,0	0.55
1010S	-10	85,9	3.38	58,4	2.30	16,0	0.63
FJ3246-							
0606S	-6	70,4	2.77	43,2	1.70	9,9	0.39
1212S	-12	95,0	3.74	62,0	2.44	19,8	0.78
FJ3249-							
0606S	-6	49,3	1.94	29,2	1.15	9,9	0.39
1212S	-12	71,6	2.82	49,3	1.94	19,6	0.77
1616S	-16	118,9	4.68	86,1	3.39	27,9	1.10

90° Elbow (Short)

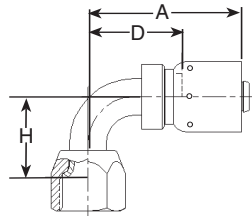

**FJ3244 -
Universal Swivel**

**FJ3247 -
SAE 45° Swivel**

**FJ3250 -
SAE 37° (JIC) Swivel**

Complete Fitting Part #	Hose Size	A		D		H	
		mm	in	mm	in	mm	in
FJ3244-							
0404S	-4	61,2	2.41	35,8	1.41	17,3	0.68
0405S‡	-5	41,2	1.62	21,1	0.83	17,3	0.68
0505S‡	-5	66,5	2.62	41,1	1.62	19,6	0.77
0808S	-8	72,9	2.87	45,2	1.78	27,7	1.09
0810S	-10	55,1	2.17	32,8	1.29	27,7	1.09
1010S	-10	88,9	3.50	61,2	2.41	31,2	1.23
FJ3247-							
0606S	-6	70,1	2.76	39,6	1.56	21,6	0.85
1212S	-12	92,5	3.64	59,4	2.34	46,2	1.82
FJ3250-							
0606S	-6	69,3	2.73	41,7	1.64	21,6	0.85
0608S	-8	47,0	1.85	26,7	1.05	21,6	0.85
1212S	-12	93,0	3.66	59,9	2.36	46,2	1.82
1216S	-16	74,7	2.94	49,5	1.95	46,2	1.82
1616S	-16	111,8	4.40	79,0	3.11	54,4	2.14

Male Pipe

FJ3152-

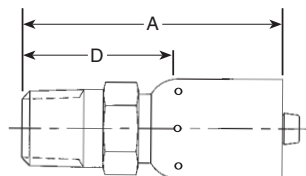

Complete Fitting Part #	Hose Size	A		D	
		mm	in	mm	in
FJ3152-					
0204S	-4	43,2	1.70	19,0	.75
0405S‡	-5	47,8	1.88	23,6	.93
0406S	-6	51,8	2.04	24,4	.96
0606S	-6	51,6	2.03	24,1	.95
0608S	-8	51,8	2.04	24,9	.98
0808S	-8	58,2	2.29	31,2	1.23
0810S	-10	61,2	2.41	33,8	1.33
1210S	-10	62,7	2.47	35,1	1.38
1212S	-12	64,0	2.52	31,8	1.25
1216S	-16	68,3	2.69	35,6	1.40
1616S	-16	73,2	2.88	40,4	1.59
2020S	-20	77,7	3.06	42,7	1.68
2424S‡	-24	85,6	3.37	50,5	1.99
3232S	-32	104,3	4.11	55,6	2.19

*Picture may not represent actual configuration.
Call Eaton Technical Assistance for details.

‡Consult Eaton for most current crimp information.

Reusable Fittings

For use with Hose:

302A, 303, 1503, 2580, 2651,
FC234, FC300, FC321, FC350,
FC355,

100R5 Style

Male Pipe

412-
44-412-

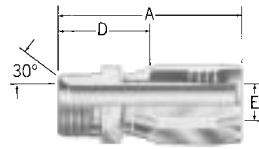

Dash Size	Thread	Hose Size	A		D		EØ	
			mm	in	mm	in	mm	in
412-								
t2-4S*	1/8-27	-04	42,7	1.68	23,4	.92	4,3	.17
t4-4S*	1/4-18	-04	47,2	1.86	28,2	1.11	4,3	.17
t2-5S*	1/8-27	-05	45,2	1.78	25,4	1.00	5,8	.23
t4-5S*	1/4-18	-05	49,8	1.96	30,0	1.18	5,8	.23
t4-6S*	1/4-18	-06	54,1	2.13	31,2	1.23	7,6	.30
t6-6S*	3/8-18	-06	54,1	2.13	31,2	1.23	6,1	.24
t6-8S*	3/8-18	-08	63,0	2.48	33,8	1.33	9,9	.39
8-8S*	1/2-14	-08	69,3	2.73	40,1	1.58	9,1	.36
t8-10S*	1/2-14	-10	73,2	2.88	40,4	1.59	12,2	.48
12-10S*	3/4-14	-10	74,7	2.94	41,9	1.65	12,2	.48
t12-12S*	3/4-14	-12	82,3	3.24	42,4	1.67	15,5	.61
t12-16S	3/4-14	-16	71,1	2.80	38,9	1.53	20,8	.82
t16-16S	1-11 1/2	-16	75,9	2.99	43,7	1.72	20,8	.82
16-20S	1-11 1/2	-20	81,3	3.20	46,7	1.72	24,1	.95
t20-20S	1 1/4-11 1/2	-20	82,0	3.23	47,5	1.87	26,7	1.05
20-24S	1 1/4-11 1/2	-24	90,9	3.58	53,8	2.12	32,5	1.28
t24-24S	1 1/2-11 1/2	-24	88,4	3.48	51,6	2.03	32,5	1.28
t32-32S	2-11 1/2	-32	102,9	4.05	55,9	2.20	44,5	1.75
44-412-								
40-40	2 1/2-8	-40	127,8	5.03	79,5	3.13	53,8	2.12
48-48	3-8	-48	129,3	5.09	81,0	3.19	68,3	2.69

Male Pipe

4412-

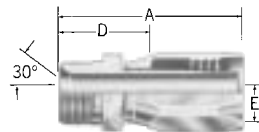

4412-	Thread	Hose Size	mm	in	mm	in	mm	in
2-4S	1/8-27	-04	42,7	1.68	23,6	.93	3,3	.13
4-4S	1/4-18	-04	47,5	1.87	28,4	1.12	3,3	.13
4-5S	1/4-18	-05	49,8	1.96	30,0	1.18	4,3	.17
4-6S†	1/4-18	-06	54,1	2.13	31,2	1.23	6,1	.24
6-6S	3/8-18	-06	54,1	2.13	31,2	1.23	5,8	.23
4-8S	1/4-18	-08	63,0	2.48	33,8	1.33	7,6	.30
6-8S	3/8-18	-08	63,0	2.48	33,8	1.33	9,1	.36
8-8S	1/2-14	-08	69,3	2.73	40,1	1.58	9,1	.36
8-10S	1/2-14	-10	73,2	2.88	40,4	1.59	11,7	.46
12-10S	3/4-14	-10	74,7	2.94	41,9	1.65	11,7	.46
8-12S	1/2-14	-12	82,3	3.24	42,7	1.68	12,4	.49
12-12S	3/4-14	-12	82,3	3.24	42,4	1.67	14,0	.55

SAE 37° (JIC) swivel

411-
44-411-

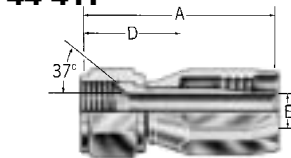

411-	Thread	Hose Size	mm	in	mm	in	mm	in
t4S*	7/16-20	-4	44,5	1.75	25,4	1.00	4,3	.17
t5S*	1/2-20	-5	48,3	1.90	28,4	1.12	5,8	.23
t6S*	9/16-18	-6	52,1	2.05	29,2	1.15	7,6	.30
t8S*	3/4-16	-8	64,0	2.52	35,1	1.38	9,9	.39
10S*	7/8-14	-10	71,1	2.80	38,4	1.51	12,2	.48
t12S*	1 1/16-12	-12	80,0	3.15	40,1	1.58	15,5	.61
t16S*	1 5/16-12	-16	71,6	2.82	39,4	1.55	20,8	.82
t20S*†††	1 5/8-12	-20	76,2	3.00	41,7	1.64	26,7	1.05
t24S*†††	1 7/8-12	-24	83,3	3.28	46,5	1.83	32,5	1.28
t32S*†††	2 1/2-12	-32	98,6	3.88	51,6	2.03	44,5	1.75
44-411-								
40*	3-12	-40	105,7	4.16	57,2	2.25	55,9	2.20
48*	3 1/2-12	-48	108,7	4.28	60,5	2.38	71,1	2.80

*Requires tools for assembly.

†Also supplied in brass. To order, substitute "B" for "S" in part number.

†††Available in stainless steel. To order, drop the "S" suffix and add "259-" prefix.

NOTE: For correct socket part number, see page 65

Reusable Fittings

100R5 Style

For use with Hose:

302A, 303, 1503, 2580, 2651,
FC234, FC300, FC321, FC350,
FC355,

SAE 37° (JIC) swivel

4411-

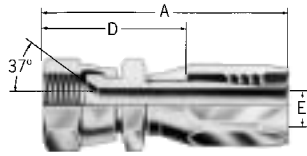

Dash Size	Thread	Hose Size	A		D		EØ	
			mm	in	mm	in	mm	in
4411-			mm	in	mm	in	mm	in
4S†††	7/16-20	-04	50,0	1.97	31,2	1.23	3,3	.13
4-5S	7/16-20	-05	52,8	2.08	33,0	1.30	4,3	.17
5S†††	1/2-20	-05	53,8	2.12	34,3	1.35	4,6	.18
6S†††	9/16-18	-06	59,2	2.33	36,3	1.43	6,1	.24
8-6S	3/4-16	-06	61,5	2.42	38,6	1.52	6,1	.24
6-8S	9/16-18	-08	68,1	2.68	38,9	1.53	7,6	.30
8S†††	3/4-16	-08	70,6	2.78	41,1	1.62	9,1	.36
10-8S	7/8-14	-08	74,9	2.95	45,7	1.80	9,1	.36
8-10S	3/4-16	-10	74,2	2.92	41,7	1.64	9,9	.39
10S†††	7/8-14	-10	78,7	3.10	46,0	1.81	11,7	.46
12-10S	11/16-12	-10	81,0	3.19	48,5	1.91	11,7	.46
10-12S	7/8-14	-12	86,4	3.40	46,5	1.83	14,0	.55
12S†††	11/16-12	-12	88,6	3.49	48,8	1.92	14,0	.55
14-12S	13/16-12	-12	90,6	3.56	50,5	1.99	14,0	.55
16S†††	15/16-12	-16	81,0	3.19	49,0	1.93	20,8	.82
20S	15/8-12	-20	87,1	3.43	52,6	2.07	26,7	1.05
20-24S	15/8-12	-24	92,7	3.65	55,6	2.19	26,9	1.06
24S	17/8-12	-24	93,5	3.68	56,4	2.22	32,5	1.28
32S	21/2-12	-32	111,5	4.39	64,8	2.55	44,5	1.75

SAE 45° swivel

401-

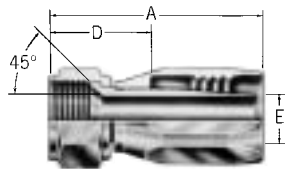

Dash Size	Thread	Hose Size	A		D		EØ	
			mm	in	mm	in	mm	in
401-			mm	in	mm	in	mm	in
4S*†	7/16-20	-04	44,5	1.75	25,4	1.00	4,3	.17
5S*†	1/2-20	-05	48,3	1.90	28,4	1.12	5,8	.23
6S*†	5/8-18	-06	52,1	2.05	29,2	1.15	7,6	.30
8S*†	3/4-16	-08	64,0	2.52	35,1	1.38	9,9	.39
10S*†	7/8-14	-10	71,1	2.80	38,4	1.51	12,2	.48
12S*†	11/16-14	-12	76,7	3.02	36,8	1.45	15,5	.61

SAE 45° swivel

4401-

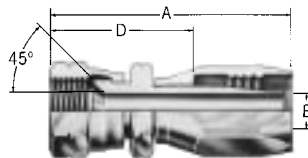

Dash Size	Thread	Hose Size	A		D		EØ	
			mm	in	mm	in	mm	in
4401-			mm	in	mm	in	mm	in
4S	7/16-20	-04	50,0	1.97	31,0	1.22	3,3	.13
5S	1/2-20	-05	53,8	2.12	34,0	1.34	4,3	.17
6S	5/8-18	-06	59,9	2.36	37,1	1.46	6,1	.24
8S	3/4-16	-08	70,6	2.78	41,1	1.62	9,1	.36
10S	7/8-14	-10	78,7	3.10	46,0	1.81	11,7	.46
12S	11/16-14	-12	88,6	3.49	48,8	1.92	14,0	.55

SAE 45° swivel

406-

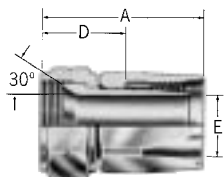

Dash Size	Thread	Hose Size	A		D		EØ	
			mm	in	mm	in	mm	in
406-			mm	in	mm	in	mm	in
16B††††*	15/16-14	-16	66,0	2.60	33,8	1.33	20,8	.82
20B††††*	15/8-14	-20	72,6	2.86	38,1	1.50	26,7	1.05
24B*	17/8-14	-24	79,5	3.13	42,4	1.67	32,5	1.28

*Requires tools for assembly.

† Also supplied in brass. To order, substitute "B" for "S" in part number.

††† Available in stainless steel. To order, drop the "S" suffix and add "259-" prefix.

†††† Also supplied in steel. To order, drop "B" suffix and substitute "S" in part number.

NOTE: For correct socket part number, see page 65.

SPECIALTY &
TRUCK HOSE

LOW & MEDIUM
PRESSURE HOSE

HIGH PRESSURE HOSE

HOSE FITTINGS

ADAPTERS &
TUBE FITTINGS

ACCESSORIES &
ASSEMBLY INSTRUCTIONS

HOSE ASSEMBLY
EQUIPMENT

APPENDICES

Reusable Fittings

100R5 Style

SAE Male O-Ring Boss**

190463-

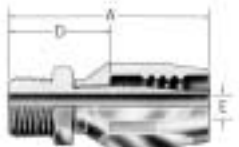

For use with Hose:

302A, 303, 1503, 2580, 2651,
FC234, FC300, FC321, FC350,
FC355,

Dash Size	Thread	Hose Size	A		D		EØ	
190463-			mm	in	mm	in	mm	in
6S	9/16-18	-06	49,5	1.95	26,7	1.05	6,1	.24
8S	3/4-16	-08	59,7	2.35	30,5	1.20	9,1	.36
10S	7/8-14	-10	66,8	2.63	34,0	1.34	9,1	.36

SAE 37° (JIC) Male Flare

4414-

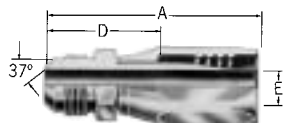

Dash Size	Thread	Hose Size	A		D		EØ	
4414-			mm	in	mm	in	mm	in
4S	7/16-20	-04	47,0	1.85	27,9	1.10	3,3	.13
5S	1/2-20	-05	49,5	1.95	29,7	1.17	4,3	.17
6S	9/16-18	-06	53,8	2.12	31,0	1.22	6,1	.24
8S	3/4-16	-08	65,3	2.57	36,1	1.42	9,1	.36
10S	7/8-14	-10	73,2	2.88	40,6	1.60	11,7	.46
12-10S	1 1/16-12	-10	77,5	3.05	44,7	1.76	11,7	.46
12S	1 1/16-12	-12	85,1	3.35	45,2	1.78	14,0	.55
16-12S	1 5/16-12	-12	86,4	3.40	46,5	1.83	14,0	.55
16S	1 5/16-12	-16	75,2	2.96	42,9	1.69	20,8	.82
20S	1 5/8-12	-20	81,8	3.22	47,2	1.86	26,7	1.05
24S	1 7/8-12	-24	87,4	3.44	50,5	1.99	32,5	1.28
32S	2 1/2-12	-32	107,2	4.22	60,5	2.38	44,5	1.75

SAE 45° Male Flare

4402-

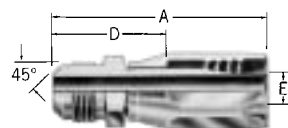

Dash Size	Thread	Hose Size	A		D		EØ	
4402-			mm	in	mm	in	mm	in
4S	7/16-20	-04	45,7	1.80	26,9	1.06	3,3	.13
4-5S	7/16-20	-05	48,3	1.90	28,4	1.12	4,3	.17
5S	1/2-20	-05	50,0	1.97	30,0	1.18	4,3	.17
6S	5/8-18	-06	55,6	2.19	32,5	1.28	6,1	.24
8S	3/4-16	-08	67,6	2.66	38,6	1.52	9,1	.36
10S	7/8-14	-10	76,2	3.00	43,7	1.72	11,7	.46
12-10S	1 1/16-14	-10	81,3	3.20	48,3	1.90	11,7	.46
12S	1 1/16-14	-12	88,9	3.50	48,8	1.92	14,2	.56

Lifesaver†

190000-

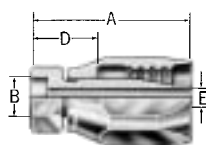

Dash Size	Tube	Hose Size	A		B†		D		EØ	
190000-			mm	in	mm	in	mm	in	mm	in
4S	1/4	-04	34,5	1.36	6,4	.25	15,7	.62	3,3	.13
5S	5/16	-05	38,9	1.53	7,9	.31	19,1	.75	4,6	.18
5-6S	5/16	-06	41,4	1.63	7,9	.31	18,5	.73	6,1	.24
6S	3/8	-06	41,4	1.63	9,7	.38	18,5	.73	6,1	.24
6-8S	3/8	-08	51,8	2.04	9,7	.38	22,6	.89	7,1	.28
8S	1/2	-08	51,8	2.04	12,7	.50	22,6	.89	9,1	.36
10S	5/8	-10	55,6	2.19	15,7	.62	22,9	.90	11,7	.46
8-12S	1/2	-12	63,2	2.49	12,7	.50	23,4	.92	9,9	.39
12S	3/4	-12	63,2	2.49	19,1	.75	23,4	.92	14,0	.55
16S	1	-16	52,1	2.05	25,4	1.00	19,8	.78	20,8	.82
16-20S	1	-20	57,4	2.26	25,4	1.00	22,9	.90	20,8	.82
18-20S	1 1/8	-20	57,4	2.26	28,4	1.12	22,9	.90	23,9	.94
20S	1 1/4	-20	57,4	2.26	31,8	1.25	22,9	.90	26,7	1.05
24-20S	1/2	-20	59,2	2.33	38,1	1.50	24,4	.96	26,7	1.05
16-24S	1	-24	61,5	2.42	25,4	1.00	24,6	.97	20,8	.82
20-24S	1 1/4	-24	59,9	2.36	31,8	1.25	22,9	.90	26,7	1.05
24-24S	1/2	-24	61,5	2.42	38,1	1.50	24,6	.97	32,5	1.28
20-32S	1 1/4	-32	73,4	2.89	31,8	1.25	26,7	1.05	26,9	1.06
24-32S	1/2	-32	71,9	2.83	38,1	1.50	24,9	.98	34,8	1.37
32-32S	2	-32	73,4	2.89	50,8	2.00	26,7	1.05	44,5	1.75
40S	2 1/2	-40	82,8	3.26	63,5	2.50	34,5	1.36	56,1	2.21

**See pages 194, 195 for o-rings.

†"B" dimension is counterbore diameter for mating tubing.

NOTE: For correct socket part number, see page 65.

Reusable Fittings

100R5 Style

For use with Hose:

302A, 303, 1503, 2580, 2651,
FC234, FC300, FC321, FC350,
FC355,

45° Elbow

**190297 -
Universal Swivel**

**190299 -
SAE 45° Swivel**

**190265 -
SAE 37° (JIC) Swivel**

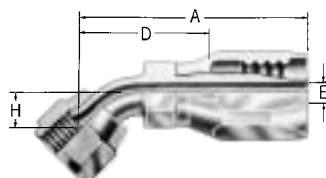

Dash Size	Thread	Hose Size	A		D		EØ		H	
190297-			mm	in	mm	in	mm	in	mm	in
4S	7/16-20	-04	47,0	1.85	27,9	1.10	3,3	.13	8,4	.33
4-5S	7/16-20	-05	51,1	2.01	31,2	1.23	3,8	.15	8,4	.33
5S	1/2-20	-05	52,6	2.07	32,8	1.29	4,6	.18	9,1	.36
8-6S	3/4-16	-06	67,1	2.64	44,2	1.74	6,1	.24	14,0	.55
8S	3/4-16	-08	75,9	2.99	46,7	1.72	9,1	.36	14,0	.55
8-10S	3/4-16	-10	79,8	3.14	47,0	1.85	9,9	.39	14,0	.55
10S	7/8-14	-10	82,3	3.24	49,5	1.95	11,7	.46	16,3	.64
10-12S	7/8-14	-12	89,9	3.54	50,0	1.97	12,2	.48	16,3	.64
190299-										
6S	5/8-18	-06	56,6	2.23	33,8	1.33	6,1	.24	9,9	.39
12S	1 1/16-14	-12	96,0	3.78	56,1	2.21	14,0	.55	19,8	.78
190265-										
6-5S	9/16-18	-05	54,1	2.13	34,3	1.35	4,3	.17	9,9	.39
6S	9/16-18	-06	56,6	2.23	33,8	1.33	6,1	.24	9,9	.39
12S	1 1/16-12	-12	96,0	3.78	56,1	2.21	14,0	.55	19,8	.78
16-12S	1 5/16-12	-12	101,6	4.00	61,7	2.43	14,0	.55	25,1	.99
16S	1 5/16-12	-16	95,0	3.74	62,7	2.47	20,8	.82	27,2	1.07
20S	1 1/8-12	-20	106,9	4.21	72,4	2.85	26,7	1.05	31,0	1.22

90° Elbow (Short)

**190296-
Universal Swivel,**

**190302-
SAE 45° Swivel,**

**190261-
SAE 37° (JIC) Swivel**

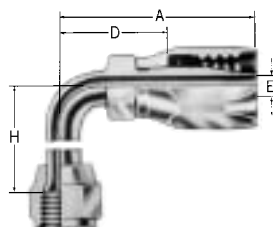

NOTE: For correct socket part number,
see page 65.

Dash Size	Thread	Hose Size	A		D		EØ		H	
190296-			mm	in	mm	in	mm	in	mm	in
4S	7/16-20	-04	44,2	1.74	25,1	.99	3,3	.13	17,3	.68
5S	1/2-20	-05	49,8	1.96	30,0	1.18	4,3	.17	19,6	.77
8S	3/4-16	-08	70,1	2.76	40,9	1.61	9,1	.36	27,7	1.09
10S	7/8-14	-10	74,7	2.94	41,9	1.65	11,7	.46	31,2	1.23
8-12S	3/4-16	-12	81,5	3.21	41,7	1.64	9,9	.39	27,7	1.09
190302-										
6S	5/8-18	-06	54,1	2.13	31,2	1.23	6,1	.24	21,6	.85
12S	1 1/16-14	-12	95,0	3.74	55,1	2.17	14,0	.55	46,2	1.82
190261-										
6S	9/16-18	-06	54,1	2.13	31,2	1.23	6,1	.24	21,6	.85
12S	1 1/16-12	-12	95,0	3.74	55,1	2.17	14,0	.55	46,2	1.82
16-12S	1 5/16-12	-12	95,0	3.74	55,1	2.17	14,0	.55	54,4	2.14
16S	1 5/16-12	-16	90,2	3.55	57,9	2.28	20,8	.82	58,4	2.30
20-16S	1 5/8-12	-16	90,2	3.55	57,9	2.28	19,3	.76	63,5	2.50
20S	1 5/8-12	-20	102,1	4.02	67,3	2.65	26,7	1.05	69,9	2.75
20-24S	1 5/8-12	-24	104,4	4.11	67,6	2.66	26,7	1.05	69,9	2.75

90° Elbow (Long)

**190295-
Universal Swivel,**

**190301-
SAE 45° Swivel,**

**190260-
SAE 37° (JIC) Swivel**

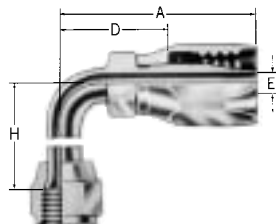

Dash Size	Thread	Hose Size	A		D		EØ		H	
190295-			mm	in	mm	in	mm	in	mm	in
4S	7/16-20	-04	44,2	1.74	25,1	.99	3,3	.13	45,7	1.80
5S	1/2-20	-05	49,8	1.96	30,0	1.18	4,6	.18	45,0	1.77
8S	3/4-16	-08	73,2	2.88	43,9	1.73	9,1	.36	61,7	2.43
10S	7/8-14	-10	81,0	3.19	48,3	1.90	11,7	.46	65,3	2.57
10-12S	7/8-14	-12	88,6	3.49	48,8	1.92	12,2	.48	65,3	2.57
190301-										
6S	5/8-18	-06	54,1	2.13	31,2	1.23	6,1	.24	55,4	2.18
12S	1 1/16-14	-12	95,0	3.74	55,1	2.17	14,0	.55	94,7	3.73
190260-										
6S	9/16-18	-06	54,1	2.13	31,2	1.23	6,1	.24	55,4	2.18
12S	1 1/16-12	-12	95,0	3.74	55,1	2.17	14,0	.55	94,7	3.73
16S	1 5/16-12	-16	90,2	3.55	57,9	2.28	20,8	.82	116,3	4.58
20S	1 5/8-12	-20	102,1	4.02	67,3	2.65	26,7	1.05	140,5	5.53

Reusable Fittings

100R5 Style

For use with Hose:

302A, 303, 1503, 2580, 2651,
FC234, FC300, FC321, FC350,
FC355,

Code 61 SAE J518 Straight Split Flange

4775-

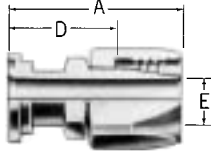

Dash Size	Flange Head Dia.		Hose Size	A		D		EØ	
	mm	in		mm	in	mm	in	mm	in
4775-									
8S	30,2	1.19	-08	70,4	2.77	41,1	1.62	9,1	.36
8-10S	30,2	1.19	-10	84,3	3.32	51,6	2.03	11,7	.46
16-10S	44,5	1.75	-10	75,4	2.97	42,7	1.68	11,7	.46
12S	38,1	1.50	-12	80,3	3.16	40,4	1.59	14,0	.55
16-12S	44,5	1.75	-12	90,2	3.55	50,3	1.98	14,0	.55
20-12S	50,8	2.00	-12	90,2	3.55	50,3	1.98	14,0	.55
16S	44,5	1.75	-16	70,4	2.77	38,1	1.50	20,8	.82
20-16S	50,8	2.00	-16	85,3	3.36	53,1	2.09	20,8	.82
24-16S	60,5	2.38	-16	86,9	3.42	54,4	2.14	20,8	.82
16-20S	44,5	1.75	-20	75,9	2.99	41,1	1.62	20,8	.82
20S	50,8	2.00	-20	90,9	3.58	56,1	2.21	26,7	1.05
32-20S	71,4	2.81	-20	92,5	3.64	57,9	2.28	26,7	1.05
16-24S	44,5	1.75	-24	94,7	3.73	57,9	2.28	20,8	.82
20-24S	50,8	2.00	-24	93,2	3.67	56,4	2.22	26,7	1.05
24S	60,5	2.38	-24	102,1	4.02	65,0	2.56	32,5	1.28
32-24S	71,4	2.81	-24	102,1	4.02	65,0	2.56	32,5	1.28
20-32S	50,8	2.00	-32	133,6	5.26	86,9	3.42	26,9	1.06
24-32S	60,5	2.38	-32	112,3	4.42	65,5	2.58	34,8	1.37
32S	71,4	2.81	-32	125,0	4.92	78,2	3.08	44,5	1.75
40-32S	84,1	3.31	-32	126,5	4.98	79,8	3.14	44,5	1.75
40	84,1	3.31	-40	136,1	5.36	87,6	3.45	56,1	2.21

Code 61 SAE J518 22¹/₂° Split Flange

4776-

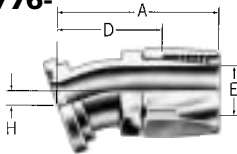

Dash Size	Flange Head Dia.		Hose Size	A		D		EØ		H	
	mm	in		mm	in	mm	in	mm	in		
4776-											
16S	44,5	1.75	-16	90,2	3.55	57,9	2.28	20,8	.82	12,7	.50
32-16S	71,4	2.81	-16	89,4	3.52	57,4	2.26	20,8	.82	12,4	.49
20S	50,8	2.00	-20	97,0	3.82	62,2	2.45	26,7	1.05	12,7	.50
32-20S	71,4	2.81	-20S	98,6	3.88	63,8	2.51	26,7	1.05	13,2	.52
32S	71,4	2.81	-32	116,6	4.59	69,9	2.75	44,5	1.75	12,7	.50

Code 61 SAE J518 30° Split Flange

198046-

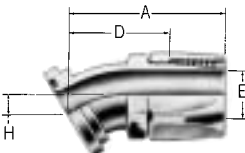

Dash Size	Flange Head Dia.		Hose Size	A		D		EØ		H	
	mm	in		mm	in	mm	in	mm	in		
198046-											
16-12S	44,5	1.75	-12	91,4	3.60	51,6	2.03	14,0	.55	11,4	.45
16S	44,5	1.75	-16	84,3	3.32	52,1	2.05	20,8	.82	12,7	.50
20-16S	50,8	2.00	-16	84,3	3.32	52,1	2.05	20,8	.82	12,7	.50
20S	50,8	2.00	-20	92,2	3.63	57,4	2.26	26,7	1.05	13,2	.52
24S	60,5	2.38	-24	100,6	3.96	63,8	2.51	32,5	1.28	14,7	.58
32S	71,4	2.81	-32	118,9	4.68	72,1	2.84	44,5	1.75	16,5	.65

NOTE: For flanges, split flange halves, kits and o-rings see pages 190-194.

NOTE: For correct socket part number, see page 65.

Reusable Fittings

100R5 Style

For use with Hose:

302A, 303, 1503, 2580, 2651,
FC234, FC300, FC321, FC350,
FC355,

Code 61 SAE J518 45° Split Flange

4777-

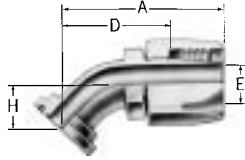

Dash Size	Flange Head Dia.		Hose Size	A		D		EØ		H	
	mm	in		mm	in	mm	in	mm	in	mm	in
4777-											
8S	30,2	1.19	-08	87,4	3.44	58,4	2.30	9,1	.36	25,4	1.00
12S	38,1	1.50	-12	102,1	4.02	62,2	2.45	14,0	.55	25,4	1.00
16-12S	44,5	1.75	-12	102,1	4.02	62,2	2.45	14,0	.55	25,4	1.00
20-12S	50,8	2.00	-12	102,1	4.02	62,2	2.45	14,0	.55	25,4	1.00
16S	44,5	1.75	-16	96,5	3.80	64,3	2.53	20,8	.82	28,4	1.12
16-20S	44,5	1.75	-20	101,9	4.01	67,3	2.65	20,8	.82	28,4	1.12
20-16S	50,8	2.00	-16	96,5	3.80	64,3	2.53	20,8	.82	28,4	1.12
20S	50,8	2.00	-20	104,6	4.12	69,9	2.75	26,7	1.05	28,4	1.12
24-20S	60,5	2.38	-20	104,6	4.12	69,9	2.75	26,7	1.05	28,4	1.12
32-20S	46,0	1.81	-20	105,7	4.16	71,1	2.80	26,7	1.05	29,7	1.17
24S	60,5	2.38	-24	111,3	4.38	74,2	2.92	32,5	1.28	28,4	1.12
24-32S	60,5	2.38	-32	121,4	4.78	74,7	2.94	34,8	1.37	28,4	1.12
32-24S	71,4	2.81	-24	111,3	4.38	74,2	2.92	32,5	1.28	28,4	1.12
32S	71,4	2.81	-32	131,6	5.18	84,6	3.33	44,5	1.75	31,8	1.25
40-32S	84,1	3.31	-32	132,6	5.22	85,9	3.38	44,5	1.75	33,0	1.30
40*	84,1	3.31	-40	167,1	6.58	118,6	4.67	56,1	2.21	42,1	1.66

Code 61 SAE J518 60° Split Flange

191395-

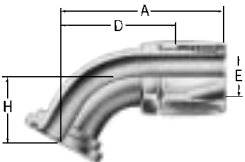

Dash Size	Flange Head Dia.		Hose Size	A		D		EØ		H	
	mm	in		mm	in	mm	in	mm	in	mm	in
4776-											
12S	38,1	1.50	-12	105,4	4.15	65,5	2.58	14,0	.55	41,1	1.62
16S	44,5	1.75	-16	98,0	3.86	66,0	2.60	20,8	.82	41,7	1.64
20S	50,8	2.00	-20	107,2	4.22	72,6	2.86	26,7	1.05	41,7	1.64
24S	60,5	2.38	-24	120,1	4.73	83,3	3.28	32,5	1.28	50,8	2.00

Code 61 SAE J518 90° Split Flange

4779-

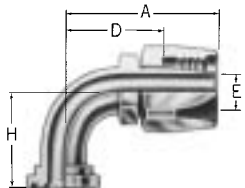

Dash Size	Flange Head Dia.		Hose Size	A		D		EØ		H	
	mm	in		mm	in	mm	in	mm	in	mm	in
4776-											
8S	30,2	1.19	-08	73,2	2.88	43,9	1.73	9,1	.36	41,1	1.62
12S	38,1	1.50	-12	95,0	3.74	55,1	2.17	14,0	.55	53,8	2.12
16-12S	44,5	1.75	-12	95,0	3.74	55,1	2.17	14,0	.55	53,8	2.12
12-16S	38,1	1.50	-16	83,8	3.30	51,6	2.03	20,8	.82	53,8	2.12
16S	44,5	1.75	-16	90,2	3.55	57,9	2.28	20,8	.82	60,5	2.38
20-16S	50,8	2.00	-16	90,2	3.55	57,9	2.28	20,8	.82	60,5	2.38
16-20S	44,5	1.75	-20	95,5	3.76	60,9	2.40	20,8	.82	60,5	2.38
20S	50,8	2.00	-20	102,1	4.02	67,3	2.65	26,7	1.05	63,5	2.50
24-20S	60,5	2.38	-20	102,1	4.02	67,3	2.65	26,7	1.05	63,5	2.50
32-20S	71,4	2.81	-20	102,1	4.02	67,3	2.65	26,7	1.05	65,0	2.56
20-24S	50,8	2.00	-24	104,4	4.11	67,6	2.66	26,7	1.05	63,5	2.50
24S	60,5	2.38	-24	112,2	4.42	75,4	2.97	32,5	1.28	69,9	2.75
24-32S	60,5	2.38	-32	122,7	4.83	75,7	2.98	34,8	1.37	69,9	2.75
32S	71,4	2.81	-32	136,9	5.39	90,2	3.55	44,5	1.75	82,6	3.25
40-32S	84,1	3.31	-32	136,9	5.39	90,2	3.55	44,5	1.75	84,1	3.31
40**	84,1	3.31	-40	184,4	7.26	136,1	5.36	56,1	2.21	131,8	5.19

NOTE: For flanges, split flange halves, kits and o-rings see pages 190-194.

NOTE: For correct socket part number, see page 65.

Reusable Fittings

100R5 Style

For use with Hose:

302A, 303, 1503, 2580, 2651,
FC234, FC300, FC321, FC350,
FC355,

Male Inverted Flare

190277-

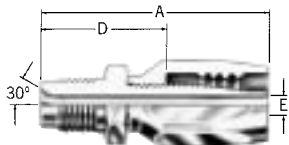

Dash Size	Thread	Hose Size	A		D		EØ
190277-			mm	in	mm	in	mm
4S	7/16-20	-04	45,7	1.80	26,7	1.05	3,3 .13

Male/Female Inverted Flare

190276-

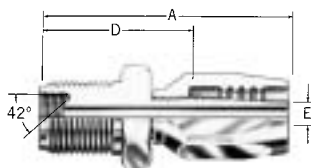

Dash Size	Thread	Hose Size	A		D		EØ
190276-			mm	in	mm	in	mm
4S	5/8-18(M)	-04	52,1	2.05	33,0	1.30	3,3 .13
	7/16-24(F)						

Female Inverted Flare

403-

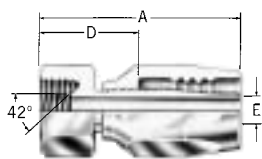

Dash Size	Thread	Hose Size	A		D		EØ
403-			mm	in	mm	in	mm
5S	1/2-20	-05	41,1	1.62	21,3	.84	5,8 .23
6S	5/8-18	-06	45,2	1.78	22,4	.88	7,6 .30

Compression Ball Sleeve

FC7031-

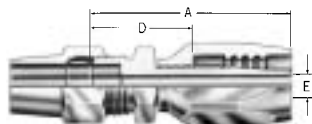

Dash Size	Thread	Hose Size	A		D		EØ
FC7031-			mm	in	mm	in	mm
0808-206	1/2	-08	59,9	2.36	30,5	1.20	9,1 .36
1010-206	5/8	-10	66,5	2.62	34,0	1.34	11,7 .46

Straight SAE Male Inverted Flare

190111-

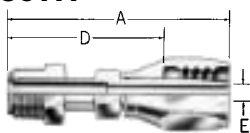

Dash Size	Thread	Hose Size	A		D		EØ
190111-			mm	in	mm	in	mm
4S	7/16-24	-04	62,5	2.46	43,4	1.71	3,3 .13
5S	1/2-20	-05	66,5	2.62	46,7	1.84	4,6 .18
5-6S	1/2-20	-06	69,1	2.72	46,2	1.82	6,1 .24
6S	5/8-18	-06	69,1	2.72	46,2	1.82	6,1 .24
6-8S	5/8-18	-08	79,5	3.13	50,8	1.98	7,1 .28
8S	3/4-18	-08	81,3	3.20	52,1	2.05	9,1 .36

NOTE: For correct socket part number, see page 65.

Reusable Fittings

100R5 Style

For use with Hose:

302A, 303, 1503, 2580, 2651,
FC234, FC300, FC321, FC350,
FC355,

15° Elbow SAE Male Inverted Flare

190350-

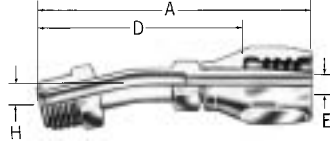

Dash Size	Thread	Hose Size	A		D		EØ		H	
			mm	in	mm	in	mm	in	mm	in
190350-										
6S	5/8-18	-06	82,8	3.26	59,9	2.36	6,1	.24	9,4	.37

45° Elbow SAE Male Inverted Flare

190371-

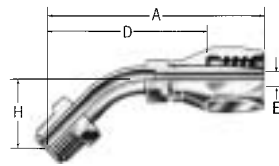

Dash Size	Thread	Hose Size	A		D		EØ		H	
			mm	in	mm	in	mm	in	mm	in
190371-										
4S	7/16-20	-04	69,6	2.74	50,5	1.99	3,3	.13	24,4	.96
5S	1/2-20	-05	73,7	2.90	53,8	2.12	4,3	.17	24,4	.96
6S	5/8-18	-06	76,2	3.00	53,3	2.10	6,1	.24	24,4	.96
8S	3/4-18	-08	86,1	3.39	56,9	2.24	9,1	.36	23,6	.93
10S	5/8-18	-10	95,0	3.74	62,0	2.44	11,7	.46	26,2	1.03

90° Elbow (Short) SAE Male Inverted Flare

190235-

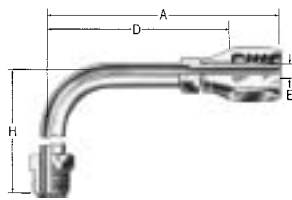

Dash Size	Thread	Hose Size	A		D		EØ		H	
			mm	in	mm	in	mm	in	mm	in
190235-										
4S	7/16-24	-04	59,9	2.36	41,1	1.62	3,3	.13	42,9	1.69
7-4S	11/16-18	-04	53,8	2.12	34,5	1.36	3,3	.13	46,7	1.84
8-4S	3/4-18	-04	53,8	2.12	34,5	1.36	3,3	.13	46,7	1.84
5S	1/2-20	-05	64,3	2.53	44,5	1.75	4,6	.18	42,9	1.69
6S	5/8-18	-06	66,8	2.63	43,9	1.73	6,1	.24	43,9	1.73
7-6S	11/16-18	-06	66,8	2.63	43,9	1.73	6,1	.24	43,9	1.73
6-8S	5/8-18	-08	77,2	3.04	48,0	1.89	7,1	.28	43,9	1.73
7-8S	11/16-18	-08	77,2	3.04	48,0	1.89	7,1	.28	43,9	1.73
8S	3/4-18	-08	77,2	3.04	48,0	1.89	9,1	.36	44,5	1.75
10S	7/8-18	-10	87,4	3.44	54,6	2.15	11,7	.46	56,4	2.22
8-12S	3/4-18	-12	88,6	3.49	48,8	1.92	9,9	.39	44,5	1.75

90° Elbow (Long) SAE Male Inverted Flare

190325-

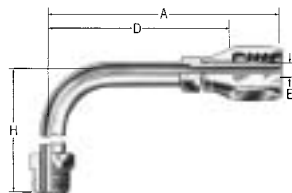

Dash Size	Thread	Hose Size	A		D		EØ		H	
			mm	in	mm	in	mm	in	mm	in
190325-										
6S	5/8-18	-06	93,2	3.67	70,4	2.77	6,1	.24	69,3	2.73

NOTE: For correct socket part number, see page 65.

SPECIALTY & TRUCK HOSE

LOW & MEDIUM PRESSURE HOSE

HIGH PRESSURE HOSE

HOSE FITTINGS

ADAPTERS & TUBE FITTINGS

ACCESSORIES & ASSEMBLY INSTRUCTIONS

HOSE ASSEMBLY EQUIPMENT

APPENDICES

Reusable Fittings

100R5 Style

For use with Hose:

302A, 303, 1503, 2580, 2651,
FC234, FC300, FC321, FC350,
FC355,

ORS Swivel Straight

FJ9706-

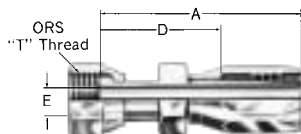

Dash Size	"T" Thread	Hose Size	A		D		EØ	
FJ9706-			mm	in	mm	in	mm	in
0404S	9/16-18	-04	53,1	2.09	34,0	1.34	3,3	.13
0405S	9/16-18	-05	51,6	2.03	31,8	1.25	4,3	.17
0606S	11/16-16	-06	61,7	2.43	38,9	1.53	6,1	.24
0808S	13/16-16	-08	79,5	3.13	50,8	1.98	9,1	.36
1010S	1-14	-10	85,6	3.37	52,8	2.08	11,7	.46
1212S	13/16-12	-12	93,5	3.68	53,6	2.11	14,0	.55
1616S	17/16-12	-16	88,9	3.50	56,6	2.23	20,8	.82
2020S	111/16-12	-20	92,5	3.64	57,9	2.28	26,7	1.05
2424S	2-12	-24	98,0	3.86	60,9	2.40	32,0	1.26

ORS Swivel 45° Elbow

FJ9707-

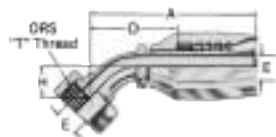

Dash Size	"T" Thread	Hose Size	A		D		EØ		H	
FJ9707-			mm	in	mm	in	mm	in	mm	in
0404S	9/16-18	-04	49,8	1.96	30,7	1.21	3,3	.13	10,4	.41
0606S	11/16-16	-06	57,7	2.27	34,8	1.37	5,6	.22	10,9	.43
0806S	13/16-16	-06	68,1	2.68	45,2	1.78	6,1	.24	15,0	.59
0808S	13/16-16	-08	77,0	3.03	47,8	1.88	9,1	.36	15,0	.59
1010S	1-14	-10	85,9	3.38	52,8	2.08	11,7	.46	16,5	.65
1212S	13/16-12	-12	97,5	3.84	57,7	2.27	14,0	.55	21,1	.83
1616S	17/16-12	-16	91,9	3.62	59,7	2.35	19,3	.76	23,9	.94
2020S	111/16-12	-20	103,9	4.09	69,1	2.72	25,7	1.01	25,4	1.00
2424S	2-12	-24	109,7	4.32	72,9	2.87	32,0	1.26	27,2	1.07

ORS Swivel 90° Elbow (Short drop)

FJ9708-

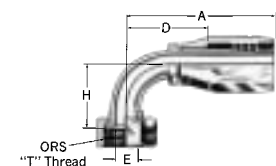

Dash Size	"T" Thread	Hose Size	A		D		EØ		H	
FJ9708-			mm	in	mm	in	mm	in	mm	in
0404S	9/16-18	-04	45,7	1.80	26,7	1.05	3,3	.13	20,8	.82
0606S	11/16-16	-06	54,1	2.13	31,2	1.23	5,6	.22	22,9	.90
0808S	13/16-16	-08	70,1	2.76	40,9	1.61	9,1	.36	29,2	1.15
1010S	1-14	-10	77,0	3.03	44,2	1.74	11,7	.46	32,3	1.27
1212S	13/16-12	-12	95,0	3.74	55,1	2.17	14,0	.55	47,8	1.88
1616S	7/16-12	-16	90,2	3.55	57,9	2.28	19,3	.76	56,1	2.21
2020S	111/16-12	-20	102,1	4.02	67,3	2.65	25,7	1.01	63,8	2.51
2424S	2-12	-24	112,2	4.42	75,4	2.97	32,0	1.26	68,6	2.70

ORS Swivel 90° Elbow (Long drop)

FJ9709-

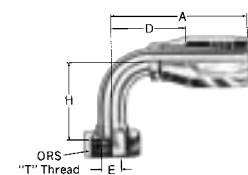

Dash Size	"T" Thread	Hose Size	A		D		EØ		H	
FJ9709-			mm	in	mm	in	mm	in	mm	in
0404S	9/16-18	-04	45,7	1.80	26,7	1.05	3,3	.13	45,7	1.80
0606S	11/16-16	-06	57,2	2.25	34,3	1.35	5,6	.22	54,1	2.13
0808S	13/16-16	-08	73,2	2.88	43,9	1.73	9,1	.36	63,8	2.51
1010S	1-14	-10	77,0	3.03	44,2	1.74	11,7	.46	70,1	2.76
1212S	13/16-12	-12	95,0	3.74	55,1	2.17	14,0	.55	96,0	3.78
1616S	7/16-12	-16	90,2	3.55	57,7	2.27	19,3	.76	114,3	4.50
2020S	111/16-12	-20	102,1	4.02	67,3	2.65	25,7	1.01	129,3	5.09
2424S	2-12	-24	112,2	4.42	75,4	2.97	32,0	1.26	140,7	5.54

NOTE: For correct socket part number, see page 65.

Reusable Fittings

100R5 Style

For use with Hose:

302A, 303, 1503, 2580, 2651,
FC234, FC300, FC321, FC350,
FC355

BSP Male

07.340-

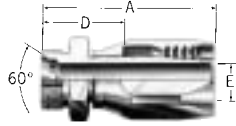

Dash Size	"T" Thread	Hose Size	A		D		EØ	
			mm	in	mm	in	mm	in
07.340-			mm	in	mm	in	mm	in
4-4	1/4-19	-04	46,5	1.83	27,5	1.08	3,2	.13
6-6	3/8-19	-06	53,0	2.09	30,0	1.18	6,0	.24
8-8	1/2-14	-08	64,0	2.52	34,5	1.35	9,0	.35
10-10	5/8-14	-10	71,0	2.80	38,0	1.50	11,5	.45
12-12	3/4-14	-12	79,5	3.13	39,5	1.56	14,0	.55
16-16	1-11	-16	71,5	2.81	39,0	1.54	21,0	.83
20-20	1 1/4-11	-20	74,0	2.91	39,5	1.56	26,5	1.04
24-24	1 1/2-11	-24	77,5	3.05	40,5	1.59	32,5	1.28
32-32	2-11	-32	95,5	3.76	48,5	1.91	44,5	1.75

BSP Female Swivel

07.421-

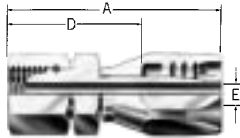

Dash Size	Thread	Hose Size	A		D		EØ	
			mm	in	mm	in	mm	in
07.421-			mm	in	mm	in	mm	in
4-4	1/4-19	-04	52,0	2.05	33,0	1.30	3,0	.13
6-6	3/8-19	-06	59,5	2.34	36,5	1.44	6,0	.24
8-6	1/2-19	-06	61,0	2.40	38,0	1.50	6,0	.24
8-8	1/2-14	-08	70,0	2.76	40,5	1.59	9,0	.35
10-10	5/8-14	-10	75,5	2.97	43,0	1.69	11,5	.45
12-10	3/4-14	-10	77,0	3.03	44,0	1.73	11,5	.45
12-12	3/4-14	-12	84,5	3.33	44,5	1.75	14,0	.55
16-16	1-11	-16	78,0	3.07	45,5	1.79	21,0	.83
20-20	1 1/4-11	-20	81,5	3.21	47,0	1.85	26,5	1.04
24-24	1 1/2-11	-24	87,0	3.43	50,0	1.97	32,5	1.28
32-32	2-11	-32	101,0	3.98	54,0	2.13	44,5	1.75

*RØ dimension is tube O.D. and refers to mating component when not called out on the illustration.

NOTE: For correct socket part number, see page 65.

Reusable Fittings

100R5 Style

For use with Hose:

302A, 303, 1503, 2580, 2651,
FC234, FC300, FC321, FC350,
FC355

Metric Male 60° DIN 7631/7647

07.024-

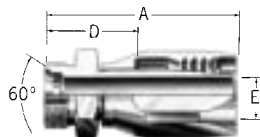

Dash Size	Thread	Hose Size	A		D		EØ	
			mm	in	mm	in	mm	in
07.024-			mm	in	mm	in	mm	in
4-4	M12 x 1.5	-04	45,0	1.77	26,0	1.02	3,2	.13
6-5	M14 x 1.5	-05	47,5	1.87	27,5	1.08	4,5	.18
8-6	M16 x 1.5	-06	50,0	1.97	27,0	1.06	6,0	.24
10-8	M18 x 1.5	-08	59,0	2.32	30,0	1.18	9,0	.35
13-10	M22 x 1.5	-10	65,0	2.56	32,0	1.26	11,5	.45
16-12	M26 x 1.5	-12	72,5	2.85	32,5	1.28	14,0	.55
20-16	M30 x 1.5	-16	63,0	2.48	31,0	1.22	21,0	.83
25-20	M38 x 1.5	-20	67,5	2.66	33,0	1.30	26,5	1.04
32-24	M45 x 1.5	-24	70,0	2.76	33,0	1.30	32,5	1.28
40-32	M52 x 1.5	-32	84,0	3.31	37,0	1.46	44,5	1.28
50-32	M65 x 2	-32	87,0	3.42	40,0	1.57	44,5	1.75
60-40	M78 x 2	-40	94,5	3.72	46,0	1.81	56,0	2.20
70-48	M90 x 2	-48	100,5	3.96	52,0	2.05	71,0	2.80

Metric Male 24° DIN 3901/3902 I.Rh.

07.003-

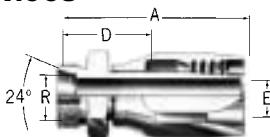

Dash Size	Thread	Hose Size	A		D		EØ		RØ	
			mm	in	mm	in	mm	in	mm	in
07.003-			mm	in	mm	in	mm	in	mm	in
6-4	M12 x 1.5	-04	45,0	1.77	26,0	1.02	3,2	.13	6,0	.24
8-5	M14 x 1.5	-05	47,5	1.87	27,5	1.08	4,5	.18	8,0	.31
10-6	M16 x 1.5	-06	51,0	2.01	28,0	1.10	6,0	.24	10,0	.39
12-6	M18 x 1.5	-06	51,0	2.01	28,0	1.10	6,0	.24	12,0	.47
12-8	M18 x 1.5	-08	60,0	2.36	30,5	1.20	9,0	.35	12,0	.47
15-10	M22 x 1.5	-10	65,0	2.56	32,0	1.26	11,5	.45	15,0	.59
18-10	M26 x 1.5	-10	65,0	2.56	32,0	1.26	11,5	.45	18,0	.71
18-12	M26 x 1.5	-12	72,5	2.85	32,5	1.28	14,0	.55	18,0	.71
22-16	M30 x 2	-16	65,0	2.56	32,5	1.28	21,0	.83	22,0	.87
28-20	M36 x 2	-20	67,5	2.66	33,0	1.30	26,5	1.04	28,0	1.10
35-24	M45 x 2	-24	72,0	2.83	35,0	1.38	32,5	1.28	35,0	1.38
42-32	M52 x 2	-32	86,0	3.38	39,0	1.54	44,5	1.75	42,0	1.65

Metric Male 24° DIN 3901/3902 s.Rh.

07.026-

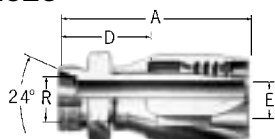

Dash Size	Thread	Hose Size	A		D		EØ		RØ	
			mm	in	mm	in	mm	in	mm	in
07.026-			mm	in	mm	in	mm	in	mm	in
8-4	M16 x 1.5	-04	47,0	1.85	28,0	1.10	3,2	.13	8,0	.31
10-5	M18 x 1.5	-05	49,5	1.95	29,5	1.16	4,5	.18	10,0	.39
12-6	M20 x 1.5	-06	52,0	2.05	29,0	1.14	6,0	.24	12,0	.47
14-8	M22 x 1.5	-08	63,0	2.48	33,5	1.32	9,0	.35	14,0	.55
16-10	M24 x 1.5	-10	67,0	2.64	34,0	1.34	11,5	.45	16,0	.63
20-12	M30 x 2	-12	78,5	3.09	38,5	1.52	14,0	.55	20,0	.79
25-16	M36 x 2	-16	69,0	2.72	36,5	1.44	21,0	.83	25,0	.98
30-20	M42 x 2	-20	73,5	2.89	39,0	1.54	26,5	1.04	30,0	1.18
38-24	M52 x 2	-24	80,0	3.15	43,0	1.69	32,5	1.28	38,0	1.50

*RØ dimension is tube O.D. and refers to mating component when not called out on the illustration.

NOTE: For correct socket part number, see page 65.

Reusable Fittings

100R5 Style

For use with Hose:

302A, 303, 1503, 2580, 2651,
FC234, FC300, FC321, FC350,
FC355

Metric Female Swivel 60° DIN 7631/7647

07.036-

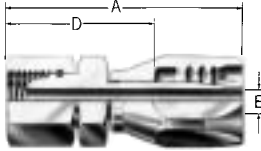

Dash Size	Thread	Hose Size	A		D		EØ	
			mm	in	mm	in	mm	in
07.036-								
20-16	M30 x 1.5	-16	72,5	2.85	40,9	1.61	21,0	.83
25-20	M38 x 1.5	-20	76,5	3.01	42,0	1.65	26,5	1.04
32-24	M45 x 1.5	-24	82,0	3.23	45,0	1.77	32,5	1.28
40-32	M52 x 1.5	-32	93,5	3.68	46,5	1.83	44,5	1.75
50-32	M65 x 2	-32	93,5	3.68	46,5	1.83	44,5	1.75
60-40	M78 x 2	-40	103,0	4.06	54,5	2.15	56,0	2.20
70-48	M90 x 2	-48	108,5	4.27	60,0	2.36	71,0	2.80

Metric Universal Female Swivel 24° DIN 3901/3902 I.Rh.

07.002-

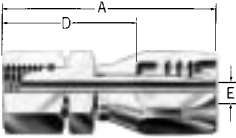

Dash Size	Thread	Hose Size	A		D		EØ		RØ	
			mm	in	mm	in	mm	in	mm	in
07.002-										
4-4†	M12 x 1.5	-04	51,0	2.01	32,0	1.26	3,2	.13	6,0	.24
6-5†	M14 x 1.5	-05	53,5	2.11	33,5	1.32	4,5	.18	8,0	.31
8-6†	M16 x 1.5	-06	56,5	2.22	33,5	1.32	6,0	.24	10,0	.39
10-8†	M18 x 1.5	-08	67,0	2.64	37,5	1.48	9,0	.35	12,0	.47
13-10†	M22 x 1.5	-10	73,0	2.87	40,5	1.59	11,5	.45	15,0	.59
16-12†	M26 x 1.5	-12	83,5	3.29	43,5	1.71	14,0	.55	18,0	.71
22-16	M30 x x 2	-16	74,0	2.91	41,5	1.63	21,0	.83	22,0	.87
28-20	M36 x x 2	-20	78,0	3.07	43,5	1.71	26,5	1.04	28,0	1.10
35-24	M45 x x 2	-24	81,5	3.21	44,5	1.75	32,5	1.28	35,0	1.38
42-32	M52 x x 2	-32	94,0	3.70	47,0	1.85	44,5	1.75	42,0	1.65

Metric Universal Female Swivel 24° DIN 3901/3902 s.Rh.

07.155-

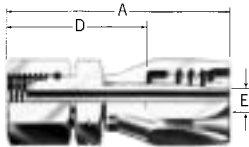

Dash Size	Thread	Hose Size	A		D		EØ		RØ	
			mm	in	mm	in	mm	in	mm	in
07.155-										
8-4	M16 x 1.5	-04	52,5	2.07	33,5	1.32	3,2	.13	08,0	.31
10-5	M18 x 1.5	-05	55,0	2.17	35,0	1.38	4,5	.18	10,0	.39
12-6	M20 x 1.5	-06	59,5	2.34	36,5	1.44	6,0	.24	12,0	.47
14-8	M22 x 1.5	-08	68,5	2.70	39,0	1.54	9,0	.35	14,0	.55
16-10	M24 x 1.5	-10	74,5	2.93	41,5	1.63	11,5	.45	16,0	.63
20-12	M30 x 2	-12	85,5	3.37	45,5	1.79	14,0	.55	20,0	.79
25-16	M36 x 2	-16	75,0	2.95	42,5	1.67	21,0	.83	25,0	.98
30-20	M42 x 2	-20	78,5	3.09	44,0	1.73	26,5	1.04	30,0	1.18
38-24	M52 x 2	-24	84,0	3.31	47,0	1.85	32,5	1.28	38,0	1.50

Komatsu 30° Metric Female Swivel

FC5954-

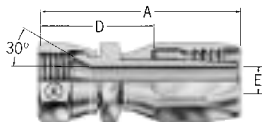

Dash Size	Thread	Hose Size	A		D		EØ	
			mm	in	mm	in	mm	in
FC5954-								
0306S	M18 x 1.5	-06	63,3	2.49	40,4	1.59	6,1	.24
0410S	M22 x 1.5	-10	78,7	3.10	46,2	1.82	9,4	.37
0512S	M24 x 1.5	-12	90,2	3.55	50,3	1.98	12,2	.48
0612S	M30 x 1.5	-12	95,5	3.76	55,6	2.19	14,0	.55
1016S	M33 x 1.5	-16	90,2	3.55	57,9	2.28	20,8	.82
1424S	M42 x 1.5	-24	107,7	4.12	67,8	2.67	30,2	1.19

*RØ dimension is tube O.D. and refers to mating component when not called out on the illustration.

NOTE: For correct socket part number, see page 65.

† Universal fitting also mates with DIN 7631/7647 60° connections.

SPECIALTY &
TRUCK HOSE

LOW & MEDIUM
PRESSURE HOSE

HIGH PRESSURE HOSE

HOSE FITTINGS

ADAPTERS &
TUBE FITTINGS

ACCESSORIES &
ASSEMBLY INSTRUCTIONS

HOSE ASSEMBLY
EQUIPMENT

APPENDICES

Reusable Fittings

100R1 TTC

For use with Hose:

FC211, GH663¹

Male Pipe

FC7985-



Dash Size	Thread	Hose Size	A	D	EØ
FC7985-			mm in	mm in	mm in
0204S	1/8-27	-04	55,1 2.17	28,7 1.13	4,3 .17
0404S	1/4-18	-04	59,9 2.36	33,5 1.32	4,3 .17
0406S	1/4-18	-06	68,1 2.68	39,4 1.55	7,6 .30
0606S	3/8-18	-06	68,1 2.68	39,4 1.55	7,9 .31
0608S	3/8-18	-08	71,6 2.82	34,3 1.35	9,9 .39
0808S	1/2-14	-08	78,0 3.07	40,6 1.60	9,9 .39
1212S	3/4-14	-12	90,2 3.55	49,5 1.95	15,5 .61
1616S	1-11 1/2	-16	108,0 4.25	54,1 2.13	20,8 .82

SAE 37° (JIC) Swivel

FC7988-

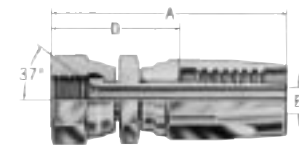

Dash Size	Thread	Hose Size	A	D	EØ
FC7988-			mm in	mm in	mm in
0404S	7/16-20	-04	63,5 2.50	37,1 1.46	4,3 .17
0606S	9/16-18	-06	73,9 2.91	45,2 1.78	7,9 .31
0808S	3/4-16	-08	80,8 3.18	43,8 1.70	9,9 .39
1212S	1 1/16-12	-12	96,5 3.80	55,9 2.20	15,5 .61
1616S	1 5/16-12	-16	110,0 4.33	56,1 2.21	20,8 .82

SAE 37° (JIC) Male Flare

FC7986-

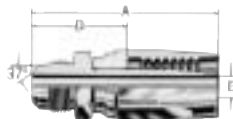

Dash Size	Thread	Hose Size	A	D	EØ
FC7986-			mm in	mm in	mm in
0404S	7/16-20	-04	59,4 2.34	33,0 1.30	4,3 .17
0606S	9/16-18	-06	67,8 2.67	39,1 1.54	7,9 .31
0808S	3/4-16	-08	75,4 2.97	38,1 1.50	9,9 .39
1212S	1 1/16-12	-12	93,0 3.66	52,3 2.06	15,5 .61
1616S	1 5/16-12	-16	107,4 4.23	53,3 2.10	20,8 .82

SAE Male O-Ring Boss

FC7987-

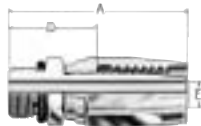

Dash Size	Thread	Hose Size	A	D	EØ
FC7987-			mm in	mm in	mm in
0606S	9/16-18	-06	63,5 2.50	34,8 1.37	7,9 .31
0808S	3/4-16	-08	68,3 2.69	31,0 1.22	9,9 .39
1212S	1 1/16-12	-12	86,4 3.40	45,7 1.80	15,5 .61
1616S	1 5/16-12	-16	96,0 3.78	41,9 1.65	20,8 .82

Lifesaver*

FC7989-

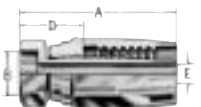

Dash Size	Thread	Hose Size	A	B*	D	EØ
FC7989-			mm in	mm in	mm in	mm in
0404S	1/4	-04	48,0 1.89	6,4 .25	21,6 .85	4,3 .17
0606S	3/8	-06	54,6 2.15	9,7 .38	25,9 1.02	7,9 .31
0808S	1/2	-08	60,5 2.38	12,7 .50	23,1 .91	9,9 .39
1212S	3/4	-12	71,1 2.80	19,1 .75	30,5 1.20	15,5 .61
1616S	1	-16	81,0 3.19	25,4 1.00	26,9 1.06	20,8 .82

*"B" dimension is counterbore for mating tubing.

¹ SAE 100R1 pressures only.

Reusable Fittings

100R1 TTC

For use with Hose:

FC211, GH663¹

SAE 37° (JIC) Swivel 45° Elbow

FC7990-

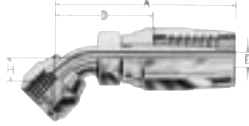

Dash Size	Thread	Hose Size	A		D		EØ		HØ	
FC7990-			mm	in	mm	in	mm	in	mm	in
0404S	7/16-20	-04	60,2	2.37	33,8	1.33	4,3	.17	8,4	.33
0606S	9/16-18	-06	69,9	2.75	41,1	1.62	7,9	.31	9,9	.39
0808S	3/4-16	-08	82,3	3.24	45,0	1.77	9,9	.39	14,0	.55
1212S	1 1/16-12	-12	103,9	4.09	63,2	2.49	15,5	.61	19,8	.78
1616S	1 5/16-12	-16	124,0	4.88	69,9	2.75	20,8	.82	27,2	1.07

SAE 37° (JIC) Swivel 90° Elbow (Short)

FC7992-

SAE 37° (JIC) Swivel 90° Elbow (Long)

FC7991-

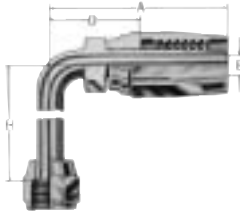

Dash Size	Thread	Hose Size	A		D		EØ		HØ	
FC7992-			mm	in	mm	in	mm	in	mm	in
0404S	7/16-20	-04	57,4	2.26	31,0	1.22	4,3	.17	17,3	.68
0606S	9/16-18	-06	67,3	2.65	38,6	1.52	7,9	.31	21,6	.85
0808S	3/4-16	-08	76,2	3.00	39,1	1.54	9,9	.39	27,7	1.09
1212S	1 1/16-12	-12	102,9	4.05	62,2	2.45	15,5	.61	46,2	1.82
1616S	1 5/16-12	-16	119,1	4.69	65,0	2.56	20,8	.82	60,7	2.39
FC7991-			mm	in	mm	in	mm	in	mm	in
0404S	7/16-20	-04	57,4	2.26	31,0	1.22	4,3	.17	45,7	1.80
0606S	5/16-18	-06	67,3	2.65	38,6	1.52	7,9	.31	55,4	2.18
0808S	3/4-16	-08	79,5	3.13	42,2	1.66	9,9	.39	61,7	2.43
1008S	7/8-14	-08	85,9	3.38	48,5	1.91	9,9	.39	65,3	2.57
1212S	1 1/16-12	-12	102,9	4.05	62,2	2.45	15,5	.61	94,7	3.73
1616S	1 5/16-12	-16	119,1	4.69	65,0	2.56	20,8	.82	116,3	4.58

Code 61 SAE J518 Straight Split Flange

FC5075-

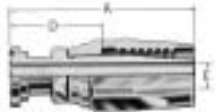

Dash Size	Thread	Hose Size	A		D		EØ	
FC5075-			mm	in	mm	in	mm	in
0808S	1.19	-08	76,5	3.01	39,1	1.54	9,9	.39
1212S	1.50	-12	88,1	3.47	47,5	1.87	15,5	.61
1616S	1.75	-16	114,3	4.50	60,5	2.38	20,8	.82

ORS Swivel Straight

FJ9724-

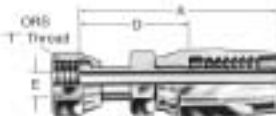

Dash Size	Thread	Hose Size	A		D		EØ	
FJ9724-			mm	in	mm	in	mm	in
0404S	7/16-20	-04	60,2	2.37	33,8	1.33	4,3	.17
0404S	9/16-18	-04	66,5	2.62	40,1	1.58	4,1	.16
0606S	1 1/16-16	-06	74,9	2.95	46,2	1.82	6,6	.26
0808S	1 3/16-16	-08	85,9	3.38	48,5	1.91	9,1	.36
1212S	1 3/16-12	-12	101,6	4.00	60,9	2.40	14,0	.55
1616S	1 7/16-12	-16	117,9	4.64	63,8	2.51	19,8	.78

ORS Swivel 45° Elbow

FJ9725-

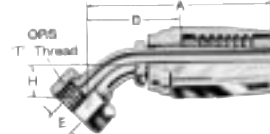

Dash Size	Thread	Hose Size	A		D		EØ		HØ	
FJ9725-			mm	in	mm	in	mm	in	mm	in
0404S	9/16-18	-04	63,0	2.48	36,6	1.44	4,3	.17	10,4	.41
0606S	1 1/16-16	-06	70,9	2.79	42,2	1.66	6,6	.26	10,9	.43
0808S	1 3/16-16	-08	83,3	3.28	46,0	1.81	9,7	.38	15,0	.59
1212S	1 3/16-12	-12	105,4	4.15	63,5	2.50	15,5	.61	21,1	.83
1616S	1 7/16-12	-16	120,9	4.76	67,1	2.64	20,6	.81	23,9	.94

¹ SAE 100R1 pressures only.

NOTE: For correct socket part number, see page 65.

NOTE: For flanges, split flange halves, kits and o-rings, see pages 190-195.

Reusable Fittings

100R1 TTC

For use with Hose:

FC211, GH663¹

ORS Swivel 90° Elbow Short Drop

FJ9726-

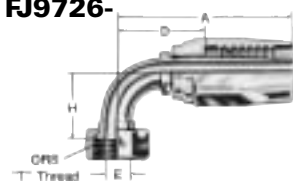

Dash Size	Thread	Hose Size	A		D		EØ		H	
			mm	in	mm	in	mm	in	mm	in
FC9726-			mm	in	mm	in	mm	in	mm	in
0404S	9/16-18	-04	58,9	2.32	32,5	1.28	4,3	.17	20,8	.82
0606S	11/16-16	-06	67,3	2.65	38,6	1.52	6,6	.26	22,9	.90
0808S	13/16-16	-08	76,5	3.01	39,1	1.54	9,7	.38	29,2	1.15
1212S	13/16-12	-12	102,9	4.05	62,2	2.45	15,5	.61	47,8	1.88
1616S	17/16-12	-16	119,1	4.69	65,3	2.57	20,6	.81	56,1	2.21

ORS Swivel 90° Elbow Long Drop

FJ9727-

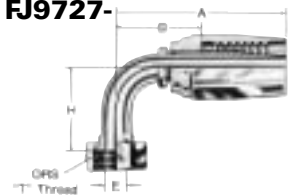

Dash Size	Thread	Hose Size	A		D		EØ		H	
			mm	in	mm	in	mm	in	mm	in
FC9727-			mm	in	mm	in	mm	in	mm	in
0404S	9/16-18	-04	58,9	2.32	32,5	1.28	4,3	.17	45,7	1.80
0606S	11/16-16	-06	70,4	2.77	41,7	1.64	6,6	.26	54,1	2.13
0808S	13/16-16	-08	79,5	3.13	42,2	1.66	9,7	.38	63,8	2.51
1212S	13/16-12	-12	102,9	4.05	62,2	2.45	15,5	.61	96,0	3.78
1616S	17/16-12	-16	119,1	4.69	65,3	2.57	20,6	.81	114,3	4.50

30° Swivel-Metric Threads Special Komatsu

FJ7199-

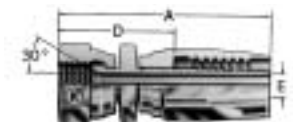

Dash Size	Thread	Hose Size	A		D		EØ	
			mm	in	mm	in	mm	in
FJ7199-			mm	in	mm	in	mm	in
0306S	M18x1.5	-06	77,2	3.04	48,3	1.90	6,4	.25
0408S	M22x1.5	-08	83,8	3.30	46,2	1.82	9,4	.37
0512S	M24x1.5	-12	98,0	3.86	57,4	2.26	12,2	.48
0612S	M30x1.5	-12	102,1	4.02	61,5	2.42	15,5	.61
1016S	M33x1.5	-16	119,9	4.72	65,8	2.59	20,3	.80

¹ SAE 100R1 pressures only.

NOTE: For correct socket part number, see page 65.

Reusable Fittings

For use with Hose:

FC310, FC510

Hi-Pac

Male Pipe

FC5131-

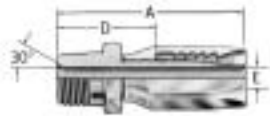

Dash Size	Thread	Hose Size	A		D		EØ	
FC5131-			mm	in	mm	in	mm	in
0404S	1/4-18	-04	62,5	2.46	31,5	1.24	4,3	.17
0406S	1/4-18	-06	69,9	2.75	32,5	1.28	7,9	.31
0606S	3/8-18	-06	69,9	2.75	32,5	1.28	7,9	.31
0808S	1/2-14	-08	74,5	3.09	36,6	1.44	9,9	.39
1212S	3/4-14	-12	91,7	3.61	44,2	1.74	15,5	.61
1616S	1-11 1/2	-16	111,8	4.40	58,2	2.29	20,8	.82
*2020S	1 1/4-11 1/2	-20	129,5	5.10	63,0	2.48	26,7	1.05

SAE 37° (JIC) Swivel

FC5130-

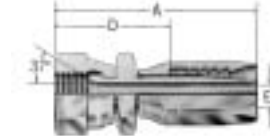

Dash Size	Thread	Hose Size	A		D		EØ	
FC5130-			mm	in	mm	in	mm	in
0404S	7/16-20	-04	66,0	2.60	35,1	1.38	4,3	.17
0606S	9/16-18	-06	75,7	2.98	38,4	1.51	7,9	.31
0806S	3/4-16	-06	79,0	3.11	41,7	1.64	7,9	.31
0808S	3/4-16	-08	81,3	3.20	40,9	1.61	9,9	.39
1008S	7/8-14	-08	84,1	3.31	45,7	1.80	9,9	.39
1010S	7/8-14	-10	87,4	3.44	46,5	1.83	12,7	.50
1212S	1 1/16-12	-12	98,0	3.86	50,5	1.99	15,5	.61
1616S	1 5/16-12	-16	113,8	4.48	60,2	2.37	20,8	.82
*2020S	1 5/8-12	-20	129,5	5.10	62,7	2.47	26,7	1.05

SAE 37° (JIC) Male Flare

FC5133-

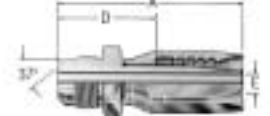

Dash Size	Thread	Hose Size	A		D		EØ	
FC5133-			mm	in	mm	in	mm	in
0404S	7/16-20	-04	62,0	2.44	31,2	1.23	4,3	.17
0606S	9/16-18	-06	69,9	2.75	32,3	1.27	7,6	.30
0806S	3/4-16	-06	73,9	2.91	36,3	1.43	7,9	.31
0808S	3/4-16	-08	75,9	2.99	34,0	1.34	9,9	.39
1008S	7/8-14	-08	78,7	3.10	36,6	1.44	9,9	.39
1010S	7/8-14	-10	81,8	3.22	40,9	1.61	12,2	.48
1212S	1 1/16-12	-12	94,5	3.72	47,0	1.85	15,5	.61
1412S	1 3/16-12	-12	95,5	3.76	47,8	1.88	15,5	.61
1616S	1 5/16-12	-16	111,3	4.38	57,7	2.27	20,8	.82
*2020S	1 5/8-12	-20	124,0	4.88	62,7	2.47	26,7	1.05

SAE Male O-Ring Boss

FC5379†-

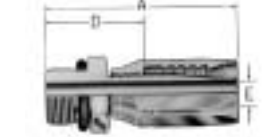

Dash Size	Thread	Hose Size	A		D		EØ	
FC5379-			mm	in	mm	in	mm	in
1008S	7/8-14	-08	72,1	2.84	30,2	1.19	9,9	.39
1208S	9/16-12	-08	76,2	3.00	34,3	1.35	9,9	.39
1616S	1 5/16-12	-16	99,8	3.93	46,2	1.82	20,8	.82
*2020S	1 5/8-12	-20	111,3	4.38	50,8	1.98	26,7	1.05

†O-ring not included. See pages 194, 195 for o-rings.

SAE 37° (JIC) Swivel 45° Elbow

FC5144-

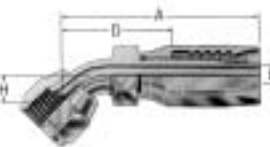

Dash Size	Thread	Hose Size	A		D		EØ		H	
FC5144-			mm	in	mm	in	mm	in	mm	in
0404S	7/16-20	-04	62,7	2.47	31,8	1.25	4,3	.17	8,4	.33
0606S	9/16-18	-06	71,6	2.82	34,3	1.35	7,9	.31	9,9	.39
0806S	3/4-16	-06	80,5	3.17	43,8	1.70	7,9	.31	14,0	.55
0808S	3/4-16	-08	57,4	2.26	39,1	1.54	9,9	.39	14,0	.55
1008S	7/8-14	-08	87,6	3.45	42,2	1.66	9,9	.39	16,3	.64
1010S	7/8-20	-10	89,9	3.54	50,5	1.99	12,7	.50	16,3	.64
1212S	1 1/16-12	-12	105,4	4.15	57,9	2.28	15,5	.61	19,8	.78
1616S	1 5/16-12	-16	127,8	5.03	74,2	2.92	20,8	.82	27,2	1.07
*2020S	1 5/8-12	-20	149,1	5.87	87,9	3.46	26,7	1.05	31,0	1.22

*FC310 only

NOTE: For correct socket part number, see page 65.

Reusable Fittings

Hi-Pac

For use with Hose:

FC310, FC510

SAE 37° (JIC) Swivel 90° Elbow (Short)

FC5143-

SAE 37° (JIC) Swivel 90° Elbow (Long)

FC5142-

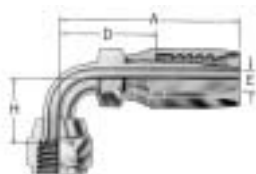

Dash Size	Thread	Hose Size	A		D		EØ		H	
			mm	in	mm	in	mm	in	mm	in
FC5143-										
0404S	7/16-20	-04	59,9	2.36	29,2	1.15	4,3	.17	17,3	.68
0606S	9/16-18	-06	69,1	2.72	31,8	1.25	7,9	.31	21,6	.85
0806S	3/4-16	-06	74,7	2.94	37,1	1.46	7,9	.31	27,7	1.09
0808S	3/4-16	-08	76,7	3.02	35,1	1.38	9,9	.39	27,7	1.09
1008S	7/8-14	-08	80,0	3.15	38,1	1.50	9,9	.39	31,2	1.23
1010S	7/8-14	-10	83,3	3.28	42,4	1.67	12,7	.50	31,2	1.23
1212S	1 1/16-12	-12	104,4	4.11	56,9	2.24	15,5	.61	46,2	1.82
1616S	1 5/16-12	-16	122,9	4.84	69,3	2.73	20,8	.82	60,7	2.39
*2020S	1 5/8-12	-20	144,0	5.67	83,1	3.27	26,7	1.05	69,9	2.75
FC5142-										
0404S	7/16-20	-04	59,9	2.36	29,2	1.15	4,3	.17	45,7	1.80
0606S	9/16-18	-06	69,1	2.72	31,8	1.25	7,9	.31	55,4	2.18
0806S	3/4-16	-06	77,7	3.06	40,3	1.59	7,9	.31	61,7	2.43
0808S	3/4-16	-08	80,0	3.15	38,1	1.50	9,9	.39	61,7	2.43
1008S	7/8-14	-08	86,4	3.40	44,5	1.75	9,9	.39	65,3	2.57
1010S	7/8-14	-10	89,7	3.53	48,8	1.92	12,7	.50	65,3	2.57
1212S	1 1/16-12	-12	104,4	4.11	56,9	2.24	15,5	.61	94,7	3.73
1616S	1 5/16-12	-16	122,9	4.84	69,3	2.73	20,8	.82	116,3	4.58
*2020S	1 5/8-12	-20	144,0	5.67	83,1	3.27	26,7	1.05	140,5	5.53

Lifesaver†

FC5380-

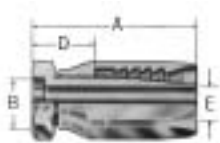

Dash Size	Thread	Hose Size	A		B†	D		EØ		
			mm	in	mm	in	mm	in	mm	in
FC5380-										
0404S	1/4	-04	50,5	1.99	6,4	.25	19,6	.77	4,3	.17
0606S	3/8	-06	56,4	2.22	9,7	.38	19,1	.75	7,9	.31
0808S	1/2	-08	60,9	2.40	12,7	.50	19,1	.75	9,9	.39
1010S	5/8	-10	64,3	2.53	15,7	.62	23,4	.92	12,7	.50
1212S	3/4	-12	72,6	2.86	19,1	.75	25,1	.99	15,5	.61
1616S	1	-16	84,8	3.34	25,4	1.00	31,2	1.23	20,8	.82
*2020S	1 1/4	-20	99,6	3.92	31,8	1.25	38,6	1.52	26,7	1.05

†"B" dimension is counterbore diameter for mating tubing.

Code 61 SAE J518 Straight Split Flange

FC5135-

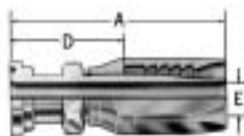

Dash Size	Flange Head Dia.		Hose Size	A		D		EØ	
	mm	in		mm	in	mm	in	mm	in
FC5135-									
0808S	30,2	1.19	-08	77,0	3.03	35,1	1.38	9,9	.39
1208S	38,1	1.50	-08	78,0	3.07	36,1	1.42	9,9	.39
1212S	38,1	1.50	-12	89,7	3.53	42,2	1.66	15,5	.61
1612S	44,5	1.75	-12	99,6	3.92	52,1	2.05	15,5	.61
1616S	44,5	1.75	-16	118,1	4.65	64,5	2.54	20,8	.82
2016S	50,8	2.00	-16	118,1	4.65	64,5	2.54	20,8	.82
*2020S	50,8	2.00	-20	132,8	5.23	71,9	2.83	26,7	1.05

*FC310 only

NOTE: For correct socket part number, see page 65.

NOTE: For flanges, split flange halves, kits and o-rings, see pages 190-195.

Reusable Fittings

Hi-Pac

For use with Hose:

FC310, FC510

Code 61 SAE J518 22½° Split Flange

FC5136-

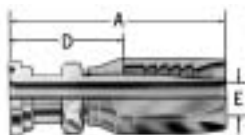

Dash Size	Flange Head Dia.		Hose Size	A		D		EØ		H	
	mm	in		mm	in	mm	in	mm	in	mm	in
FC5136-											
0808S	30,2	1.19	-08	95,5	3.76	53,6	2.11	9,9	.39	12,7	.50
1212S	38,1	1.50	-12	109,7	4.32	62,0	2.44	15,5	.61	12,7	.50
1612S	44,5	1.75	-12	109,7	4.32	62,0	2.44	15,5	.61	12,7	.50
1616S	44,5	1.75	-16	122,9	4.84	69,3	2.73	20,8	.82	12,7	.50
2016S	50,8	2.00	-16	122,9	4.84	69,3	2.73	20,8	.82	12,7	.50
*2020S	50,8	2.00	-20	138,9	5.47	78,0	3.07	26,7	1.05	12,7	.50

Code 61 SAE J518 30° Split Flange

FC5137-

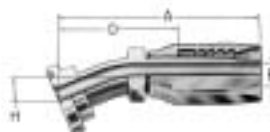

Dash Size	Flange Head Dia.		Hose Size	A		D		EØ		H	
	mm	in		mm	in	mm	in	mm	in	mm	in
FC5137-											
1212S	38,1	1.50	-12	111,3	4.38	63,8	2.51	15,5	.61	17,5	.69
1612S	44,5	1.75	-12	111,3	4.38	63,8	2.51	15,5	.61	17,5	.69
1616S	44,5	1.75	-16	117,1	4.61	63,5	2.50	20,8	.82	12,7	.50
2016S	50,8	2.00	-16	117,1	4.61	63,5	2.50	20,8	.82	12,7	.50
*2020S	50,8	2.00	-20	153,7	6.05	92,7	3.65	26,7	1.05	24,4	.96

Code 61 SAE J518 45° Split Flange

FC5138-

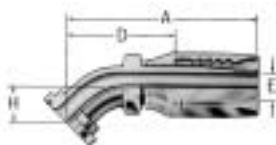

Dash Size	Flange Head Dia.		Hose Size	A		D		EØ		H	
	mm	in		mm	in	mm	in	mm	in	mm	in
FC5138-											
0808S	30,2	1.19	-08	94,2	3.71	52,3	2.06	9,9	.39	25,4	1.00
1212S	38,1	1.50	-12	110,2	4.34	62,7	2.47	15,5	.61	25,4	1.00
1612S	44,5	1.75	-12	111,5	4.39	64,0	2.52	15,5	.61	25,4	1.00
1616S	44,5	1.75	-16	129,3	5.09	75,7	2.98	20,8	.82	28,4	1.12
2016S	50,8	2.00	-16	129,3	5.09	75,7	2.98	20,8	.82	28,4	1.12
*2020S	50,8	2.00	-20	146,6	5.77	85,6	3.37	26,7	1.05	28,4	1.12

Code 61 SAE J518 60° Split Flange

FC5139-



Dash Size	Flange Head Dia.		Hose Size	A		D		EØ		H	
	mm	in		mm	in	mm	in	mm	in	mm	in
FC5139-											
1212S	38,1	1.50	-12	114,8	4.52	67,3	2.65	15,5	.61	41,1	1.62
1612S	44,5	1.75	-12	114,8	4.52	67,3	2.65	15,5	.61	41,1	1.62
1616S	44,5	1.75	-16	130,8	5.15	77,2	3.04	20,8	.82	41,7	1.64
2016S	50,8	2.00	-16	130,8	5.15	77,2	3.04	20,8	.82	41,7	1.64
*2020S	50,8	2.00	-20	149,4	5.88	88,4	3.48	26,7	1.05	41,7	1.64

Code 61 SAE J518 67½° Split Flange

FC5140-



Dash Size	Flange Head Dia.		Hose Size	A		D		EØ		H	
	mm	in		mm	in	mm	in	mm	in	mm	in
FC5140-											
0808S	30,2	1.19	-08	88,1	3.47	46,2	1.82	9,9	.39	35,1	1.38
1212S	38,1	1.50	-12	111,0	4.37	63,5	2.50	15,5	.61	41,1	1.62
1612S	44,5	1.75	-12	111,0	4.37	63,5	2.50	15,5	.61	41,1	1.62
1616S	44,5	1.75	-16	128,7	5.07	75,2	2.96	20,8	.82	44,5	1.75
2016S	50,8	2.00	-16	128,7	5.07	75,2	2.96	20,8	.82	44,5	1.75
*2020S	50,8	2.00	-20	149,1	5.87	87,9	3.46	26,7	1.05	47,8	1.88

NOTE: For flanges, split flange halves, kits and o-rings, see pages 190-195.

Note: For correct socket part number, see page 65.

*FC310 only

SPECIALTY &
TRUCK HOSE

LOW & MEDIUM
PRESSURE HOSE

HIGH PRESSURE HOSE

HOSE FITTINGS

ADAPTERS &
TUBE FITTINGS

ACCESSORIES &
ASSEMBLY INSTRUCTIONS

HOSE ASSEMBLY
EQUIPMENT

APPENDICES

Reusable Fittings

For use with Hose:

FC310, FC510

Hi-Pac

Code 61 SAE J518 90° Split Flange

FC5141-

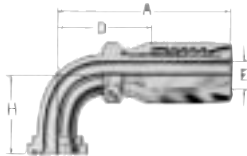

Dash Size	Flange Head Dia.	Hose Size	A	D	EØ	H
FC5141-	mm in		mm in	mm in	mm in	mm in
0808S	30,2 1.19	-08	80,0 3.15	38,1 1.50	9,9 .39	41,1 1.62
1208S	38,1 1.50	-08	80,0 3.15	38,1 1.50	9,9 .39	41,1 1.62
1212S	38,1 1.50	-12	104,4 4.11	56,9 2.24	15,5 .61	53,8 2.12
1612S	44,5 1.75	-12	104,4 4.11	56,9 2.24	15,5 .61	53,8 2.12
1616S	44,5 1.75	-16	122,9 4.84	69,3 2.73	20,8 .82	60,5 2.38
2016S	50,8 2.00	-16	122,9 4.84	69,3 2.73	20,8 .82	60,5 2.38
*2020S	50,8 2.00	-20	144,0 5.67	82,8 3.26	26,7 1.05	63,5 2.50

ORS Swivel Straight

FJ9728-

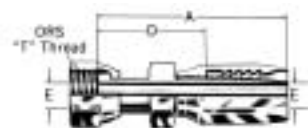

Dash Size	Flange Head Dia.	Hose Size	A	D	EØ	H
FC9728-	mm in		mm in	mm in	mm in	
0404S	9/16-18	-04	68,8 2.71	38,1 1.50	4,3 .17	
0606S	11/16-16	-06	76,7 3.02	39,4 1.55	6,6 .26	
0808S	13/16-16	-08	86,4 3.40	44,5 1.75	9,9 .39	
1010S	1-14	-10	91,9 3.62	51,1 2.01	12,7 .50	
1212S	13/16-12	-12	102,9 4.05	55,4 2.18	15,5 .61	
1616S	17/16-12	-16	121,4 4.78	68,1 2.68	20,8 .82	
*2020S	111/16-12	-20	134,6 5.30	73,7 2.90	26,7 1.05	

ORS Swivel 45° Elbow

FJ9729-

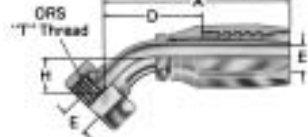

Dash Size	Flange Head Dia.	Hose Size	A	D	EØ	H
FC9729-	mm in		mm in	mm in	mm in	mm in
0404S	9/16-18	-04	65,5 2.58	34,5 1.36	3,8 .15	10,4 .41
0606S	11/16-16	-06	72,6 2.86	35,3 1.39	6,1 .24	10,9 .43
0808S	13/16-16	-08	83,8 3.30	41,9 1.65	9,4 .37	15,0 .59
1010S	1-14	-10	91,9 3.62	51,1 2.01	11,7 .46	16,5 .65
1212S	13/16-12	-12	106,9 4.21	59,4 2.34	14,7 .58	21,1 .83
1616S	17/16-12	-16	124,7 4.91	71,1 2.80	19,3 .76	23,9 .94
*2020S	111/16-12	-20	145,8 5.74	84,8 3.34	25,7 1.01	25,4 1.00

ORS Swivel 90° Elbow Short Drop

FJ9730-

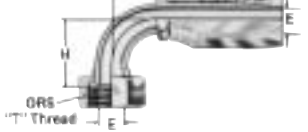

Dash Size	Flange Head Dia.	Hose Size	A	D	EØ	H
FC9730-	mm in		mm in	mm in	mm in	mm in
0404S	9/16-18	-04	61,5 2.42	30,7 1.21	3,8 .15	20,8 .82
0606S	11/16-16	-06	69,1 2.72	31,8 1.25	6,1 .24	22,9 .90
0808S	13/16-16	-08	76,7 3.02	35,1 1.38	9,4 .37	29,2 1.15
1010S	1-14	-10	83,3 3.28	42,4 1.67	11,7 .46	32,3 1.27
1212S	13/16-12	-12	104,4 4.11	56,9 2.24	14,7 .58	47,8 1.88
1616S	17/16-12	-16	122,9 4.84	69,3 2.73	19,3 .76	56,1 2.21
*2020S	111/16-12	-20	144,0 5.67	82,8 3.26	25,7 1.01	63,8 2.51

ORS Swivel 90° Elbow Long Drop

FJ9731-

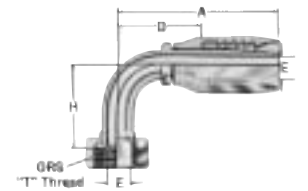

Dash Size	Flange Head Dia.	Hose Size	A	D	EØ	H
FC9731-	mm in		mm in	mm in	mm in	mm in
0404S	9/16-18	-04	61,5 2.42	30,7 1.21	3,8 .15	45,7 1.80
0606S	11/16-16	-06	72,4 2.85	34,8 1.37	6,1 .24	54,1 2.13
0808S	13/16-16	-08	80,0 3.15	38,1 1.50	9,4 .37	63,8 2.51
1010S	1-14	-10	83,3 3.28	42,4 1.67	11,7 .46	70,1 2.76
1212S	13/16-12	-12	104,4 4.11	56,9 2.24	14,7 .58	96,0 3.78
1616S	17/16-12	-16	122,9 4.84	69,3 2.73	19,3 .76	114,3 4.50
*2020S	111/16-12	-20	144,0 5.67	82,8 3.26	25,7 1.01	129,3 5.09

NOTE: For flanges, split flange halves, kits and o-rings, see pages 190-195.

Note: For correct socket part number, see page 65.

*FC310 only

Reusable Fittings

Hi-Pac

For use with Hose:

FC310, FC510

30° Swivel-Metric Threads Special Komatsu

FJ7201-

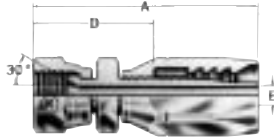

Dash Size	Thread	Hose Size	A		D		EØ	
			mm	in	mm	in	mm	in
FJ7201-			mm	in	mm	in	mm	in
0306S	M18x1.5	-06	79,0	3.11	41,7	1.64	6,4	.25
0408S	M22x1.5	-08	84,3	3.32	42,2	1.66	9,4	.37
0510S	M24x1.5	-10	90,9	3.58	50,0	1.97	12,7	.50
0612S	M30x1.5	-12	103,6	4.08	56,4	2.22	15,5	.61
1016S	M33x1.5	-16	123,4	4.86	70,1	2.76	20,3	.80
1220S	M36x1.5	-20	138,7	5.46	77,7	3.06	24,1	.95

Komatsu Split Flange

FJ7202-

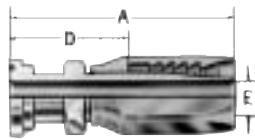

Dash Size	Flange Head Dia.		Hose Size	A		D		EØ	
	mm	in		mm	in	mm	in	mm	in
FJ7202-	mm	in		mm	in	mm	in	mm	in
1010S	34,3	1.35	-10	114,8	4.52	73,9	2.91	11,7	.46

Komatsu Split Flange 45° Elbow

FJ7203-

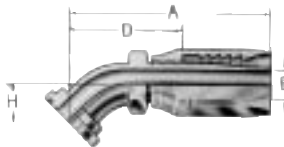

Dash Size	Flange Head Dia.		Hose Size	A		D		EØ		H
	mm	in		mm	in	mm	in	mm	in	
FJ7203-	mm	in		mm	in	mm	in	mm	in	mm
1010S	34,3	1.35	-10	96,5	3.80	55,6	2.19	11,7	.46	21,8

Komatsu Split Flange 90° Elbow

FJ7204-



Dash Size	Flange Head Dia.		Hose Size	A		D		EØ		H
	mm	in		mm	in	mm	in	mm	in	
FJ7204-	mm	in		mm	in	mm	in	mm	in	mm
1010S	34,3	1.35	-10	89,7	3.53	48,8	1.92	11,7	.46	76,7

Note: For correct socket part number, see page 65.

*FC310 only

Komatsu split flange fittings require the use of a special o-ring.

SPECIALTY & TRUCK HOSE

LOW & MEDIUM PRESSURE HOSE

HIGH PRESSURE HOSE

HOSE FITTINGS

ADAPTERS & TUBE FITTINGS

ACCESSORIES & ASSEMBLY INSTRUCTIONS

HOSE ASSEMBLY EQUIPMENT

APPENDICES

Reusable Fittings

100R2 Skive Style

For use with Hose:

2766, 2781¹, FC195¹

Male Pipe

4722-

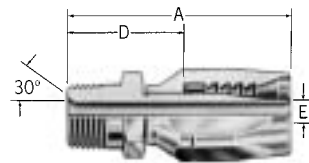

Dash Size	Thread	Hose Size	A		D		EØ	
			mm	in	mm	in	mm	in
4722-								
4-4S	1/4-18	-04	63,5	2.50	32,0	1.26	4,3	.17
6-4S	3/8-18	-04	65,0	2.56	33,5	1.32	4,3	.17
6-6S	3/8-18	-06	69,9	2.75	32,5	1.28	7,9	.31
6-8S	3/8-18	-08	72,1	2.84	33,5	1.32	9,9	.39
8-8S	1/2-14	-08	74,5	3.09	40,1	1.58	9,9	.39
8-10S	1/2-14	-10	80,8	3.18	41,4	1.63	12,7	.50
12-12S	3/4-14	-12	91,7	3.61	44,2	1.74	15,5	.61
16-12S	1-11 1/2	-12	99,6	3.92	52,3	2.06	15,5	.61
16-16S	1-11 1/2	-16	111,8	4.40	59,9	2.36	20,8	.82
20-20S	1 1/4-11 1/2	-20	124,5	4.90	65,8	2.59	26,7	1.05
24-24S	1 1/2-11 1/2	-24	126,5	4.98	69,6	2.74	32,5	1.28
32-32S	2-11 1/2	-32	139,7	5.50	77,5	3.05	44,5	1.75

SAE 37° (JIC) Swivel

4721-

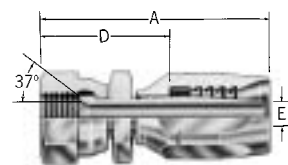

Dash Size	Thread	Hose Size	A		D		EØ	
			mm	in	mm	in	mm	in
4721-								
4-4S	7/16-20	-04	67,1	2.64	35,8	1.41	4,3	.17
5-4S	1 1/2-20	-04	69,1	2.72	37,8	1.49	4,3	.17
6-4S	9/16-18	-04	70,9	2.79	39,6	1.56	4,3	.17
6-6S	9/16-18	-06	75,7	2.98	38,4	1.51	6,6	.26
8-6S	3/4-16	-06	79,0	3.11	41,4	1.63	7,9	.31
8-8S	3/4-16	-08	81,3	3.20	42,7	1.68	9,9	.39
10-8S	7/8-14	-08	84,1	3.31	45,7	1.80	9,9	.39
12-8S	1 1/16-12	-08	86,4	3.40	48,0	1.89	9,9	.39
10S	7/8-14	-10	86,4	3.40	47,0	1.85	12,7	.50
12-10S	1 1/16-12	-10	88,9	3.50	49,3	1.94	12,7	.50
12S	1 1/16-12	-12	98,0	3.86	50,5	1.99	15,5	.61
14-12S	1 3/16-12	-12	100,1	3.94	52,3	2.06	15,5	.61
16-12S	1 5/16-12	-12	101,6	4.00	54,1	2.13	15,5	.61
16S	1 5/16-12	-16	113,8	4.48	61,7	2.43	20,8	.82
20S	1 5/8-12	-20	129,5	5.10	70,6	2.78	26,7	1.05
24S	1 7/8-12	-24	131,1	5.16	74,4	2.93	32,5	1.28
32S	2 1/2-12	-32	149,9	5.90	88,1	3.47	44,5	1.75

SAE 37° (JIC) Swivel

4721-

316 stainless steel

259-4721-

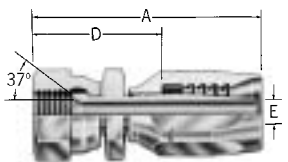

Dash Size	Thread	Hose Size	A		D		EØ	
			mm	in	mm	in	mm	in
259-4721-								
4-4	7/16-20	-04	67,1	2.64	35,8	1.41	4,3	.17
6-4	9/16-18	-04	70,9	2.79	39,6	1.56	4,3	.17
6-6	9/16-18	-06	75,7	2.98	38,4	1.51	6,6	.26
8-6	3/4-16	-06	79,0	3.11	41,7	1.64	7,9	.31
8-8	3/4-16	-08	81,3	3.20	42,7	1.68	9,9	.39
10-8	7/8-14	-08	84,1	3.31	45,7	1.80	9,9	.39
10	7/8-14	-10	86,4	3.40	47,0	1.85	12,7	.50
12	1 1/16-12	-12	98,0	3.86	50,5	1.99	15,5	.61
16	1 5/16-12	-16	113,8	4.48	61,5	2.42	20,8	.82

Note: For correct socket part number, see page 65.

¹SAE 100R2 pressures only.

Reusable Fittings

100R2 Skive Style

For use with Hose:

2766, 2781¹, FC195¹

SAE Male O-Ring Boss

190464†-

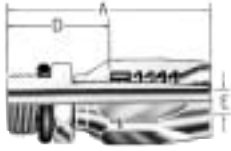

Dash Size	Thread	Hose Size	A		D		EØ	
			mm	in	mm	in	mm	in
190464-			mm	in	mm	in	mm	in
8S	3/4-16	-08	68,8	2.71	30,5	1.20	9,9	.39
10-8S	7/8-14	-08	72,1	2.84	33,8	1.33	9,9	.39
12-8S	1 1/16-12	-08	76,2	3.00	37,8	1.49	9,9	.39
12S	1 1/16-12	-12	87,9	3.46	40,3	1.59	15,5	.61
14-12S	1 3/16-12	-12	87,9	3.46	40,3	1.59	15,5	.61
16S	1 5/8-12	-16	99,8	3.93	47,5	1.87	20,8	.82
20S	1 5/8-12	-20	111,8	4.40	52,6	2.07	26,7	1.05
24S	1 7/8-12	-24	109,5	4.31	52,6	2.07	32,5	1.28
32S	2 1/2-12	-32	118,9	4.68	56,6	2.23	44,5	1.75

†O-ring not included. See page 195 for o-rings.

SAE 37° (JIC) Male Flare

4725-

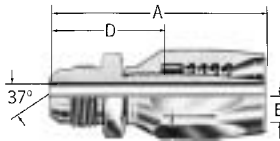

Dash Size	Thread	Hose Size	A		D		EØ	
			mm	in	mm	in	mm	in
4725-			mm	in	mm	in	mm	in
4-4S	7/16-20	-4	63,2	2.49	31,8	1.25	4,3	.17
5-4S	1/2-20	-4	63,2	2.49	31,8	1.25	4,3	.17
6-4S	9/16-18	-4	64,8	2.55	33,8	1.33	4,3	.17
6-6S	9/16-18	-6	69,9	2.75	32,5	1.28	7,6	.30
8-6S	3/4-16	-6	73,9	2.91	36,6	1.44	7,9	.31
8-8S	3/4-16	-8	75,9	2.99	37,6	1.48	9,9	.39
10-8S	7/8-14	-8	78,7	3.10	40,3	1.59	9,9	.39
10S	7/8-14	-10	81,0	3.19	41,7	1.64	13,0	.51
12-8S	1 1/16-12	-8	82,8	3.26	44,5	1.75	9,9	.39
12-10S	1 1/16-12	-10	85,3	3.36	46,0	1.81	12,7	.50
12S	1 1/16-12	-12	94,5	3.72	47,0	1.85	15,5	.61
14-12S	1 3/16-12	-12	95,5	3.76	47,8	1.88	15,5	.61
16-12S	1 5/16-12	-12	99,1	3.90	51,6	2.03	15,5	.61
16S	1 5/16-12	-16	111,3	4.38	59,2	2.33	20,8	.82
20S	1 5/8-12	-12	124,2	4.89	65,5	2.58	26,7	1.05
24S	1 7/8-12	-24	128,5	5.06	71,6	2.82	32,5	1.28

Lifesaver*

191000-

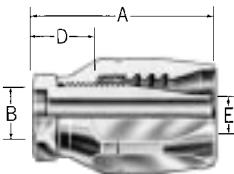

Dash Size	Tube Size	Hose Size	A		D		EØ		H	
			mm	in	mm	in	mm	in	mm	in
191000-			mm	in	mm	in	mm	in	mm	in
4S	1/4	-04	51,6	2.03	6,4	.25	20,3	.80	4,3	.17
6S	3/8	-06	56,4	2.22	9,7	.38	19,1	.75	7,9	.31
8-6S	1/2	-06	58,9	2.32	12,7	.50	21,3	.84	7,9	.31
8S	1/2	-08	60,9	2.40	12,7	.50	22,6	.89	9,9	.39
10-8S	5/8	-08	60,9	2.40	15,7	.62	22,6	.89	9,9	.39
10S	5/8	-10	63,5	2.50	15,7	.62	23,9	.94	12,7	.50
12S	3/4	-12	72,6	2.86	19,1	.75	25,1	.99	15,5	.61
16-12S	1	-12	72,6	2.86	25,4	1.00	25,1	.99	15,5	.61
16S	1	-16	84,8	3.34	25,4	1.00	32,8	1.29	20,8	.82
20-16S	1 1/4	-16	87,9	3.46	31,8	1.25	36,1	1.42	20,8	.82
24-16S	1 1/2	-16	89,7	3.53	38,1	1.50	37,6	1.48	20,8	.82
16-20S	1	-20	100,1	3.94	25,4	1.00	41,1	1.62	20,8	.82
20-20S	1 1/4	-20	100,1	3.94	31,8	1.25	41,1	1.62	26,7	1.05
24-20S	1 1/2	-20	101,6	4.00	38,1	1.50	42,7	1.68	26,7	1.05
20-24S	1 1/4	-24	99,3	3.91	31,8	1.25	42,7	1.68	26,7	1.05
24S	1 1/2	-24	99,3	3.91	38,1	1.50	42,7	1.68	32,5	1.28
32S	2	-32	110,2	4.34	50,8	2.00	41,7	1.64	44,5	1.75

*"B" dimension is counterbore diameter for mating tubing.

Also available with metric and jump size counterbores.

Note: For correct socket part number, see page 65.

¹SAE 100R2 pressures only.

Reusable Fittings

100R2 Skive Style

For use with Hose:

2766, 2781¹, FC195¹

SAE 37° (JIC) Swivel 45° Elbow

190287-

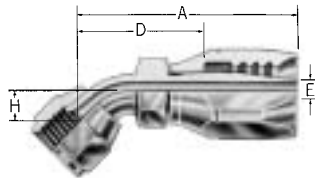

Dash Size	Thread	Hose Size	A		D		EØ		H	
			mm	in	mm	in	mm	in	mm	in
190287-										
4S	7/16-20	-04	63,8	2.51	32,5	1.28	4,3	.17	8,4	.33
6S	9/16-18	-06	71,6	2.82	34,3	1.35	7,9	.31	9,9	.39
8-6S	3/4-16	-06	80,5	3.17	43,8	1.70	7,9	.31	14,0	.55
8S	3/4-16	-08	82,8	3.26	44,5	1.75	9,9	.39	14,0	.55
10-8S	7/8-14	-08	87,6	3.45	49,3	1.94	9,9	.39	16,3	.64
10S	7/8-14	-10	89,9	3.54	50,5	1.99	12,7	.50	16,3	.64
12S	11/16-12	-12	105,4	4.15	57,9	2.28	15,5	.61	19,8	.78
16S	15/16-12	-16	127,8	5.03	75,4	2.97	20,8	.82	27,2	1.07
20S	15/8-12	-20	149,4	5.88	90,4	3.56	26,7	1.05	31,0	1.22

SAE 37° (JIC) Swivel

90° Elbow (Short) 190264-

90° Elbow (Long) 190263-

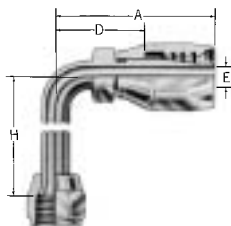

Dash Size	Thread	Hose Size	A		D		EØ		H	
			mm	in	mm	in	mm	in	mm	in
190264-										
4S	7/16-20	-04	60,9	2.40	29,7	1.17	4,3	.17	17,3	.68
6S	9/16-18	-06	69,1	2.72	31,8	1.25	7,9	.31	21,6	.85
8-6S	3/4-16	-06	74,7	2.94	37,1	1.46	7,9	.31	27,7	1.09
8S	3/4-16	-08	76,7	3.02	38,6	1.52	9,9	.39	27,7	1.09
10-8S	7/8-14	-08	80,0	3.15	41,7	1.64	9,9	.39	31,2	1.23
10S	7/8-14	-10	82,3	3.24	42,9	1.69	12,7	.50	31,2	1.23
12S	11/16-12	-12	104,4	4.11	56,9	2.24	15,5	.61	46,2	1.82
16S	15/16-12	-16	122,9	4.84	70,9	2.79	20,8	.82	60,7	2.39
20S	15/8-12	-20	144,3	5.68	85,3	3.36	26,7	1.05	69,9	2.75
190263-										
4S	7/16-20	-04	60,9	2.40	29,7	1.17	4,3	.17	45,7	1.80
6S	9/16-18	-06	69,1	2.72	31,8	1.25	7,9	.31	55,4	2.18
8-6S	3/4-16	-06	77,7	3.06	40,3	1.59	7,9	.31	61,7	2.43
8S	3/4-16	-08	80,0	3.15	41,7	1.64	9,9	.39	61,7	2.43
10-8S	7/8-14	-08	86,4	3.40	48,0	1.89	9,9	.39	65,3	2.57
10S	7/8-14	-10	88,9	3.50	49,3	1.94	12,7	.50	65,3	2.57
12S	11/16-12	-12	104,4	4.11	56,9	2.24	15,5	.61	94,7	3.73
16S	15/16-12	-16	122,9	4.84	70,6	2.78	20,8	.82	116,3	4.58
20S	15/8-12	-20	144,3	5.68	85,3	3.36	26,7	1.05	140,5	5.53

NOTE: For socket part numbers, see page 65.

¹SAE 100R2 pressures only.

Reusable Fittings

100R2 Skive Style

For use with Hose:

2766, 2781¹, FC195¹

Code 61 SAE J518 Straight Split Flange

4744-

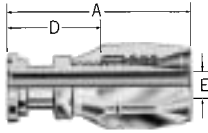

Dash Size	Flange Head Dia.		Hose Size	A		D		EØ	
	mm	in		mm	in	mm	in	mm	in
4744-									
8S	30,2	1.19	-08	77,0	3.03	38,6	1.52	9,9	.39
12-8S	38,1	1.50	-08	78,0	3.07	39,6	1.56	9,9	.39
12S	38,1	1.50	-12	89,7	3.53	42,2	1.66	15,5	.61
16-12S	44,5	1.75	-12	99,6	3.92	52,1	2.05	15,5	.61
16S	44,5	1.75	-16	118,1	4.65	65,8	2.59	20,8	.82
20-16S	50,8	2.00	-16	118,1	4.65	66,0	2.60	20,8	.82
24-16S	60,5	2.38	-16	119,9	4.72	67,6	2.66	20,8	.82
16-20S	44,5	1.75	-20	142,5	5.61	83,6	3.29	20,8	.82
20S	50,8	2.00	-20	133,4	5.25	74,4	2.93	26,7	1.05
24-20S	60,5	2.38	-20	133,4	5.25	74,4	2.93	26,7	1.05
24S	60,5	2.38	-24	140,0	5.51	83,1	3.27	32,5	1.28
20-24S	50,8	2.00	-24	132,6	5.22	75,9	2.99	26,7	1.05
32-24S	71,4	2.81	-24	140,0	5.51	83,1	3.27	32,5	1.28
32S	71,4	2.81	-32	161,8	6.37	99,8	3.93	44,5	1.75

Code 61 SAE J518 22½° Split Flange

4720-

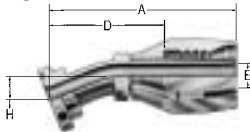

Dash Size	Flange Head Dia.		Hose Size	A		D		EØ		H	
	mm	in		mm	in	mm	in	mm	in		
4720-											
8S	30,2	1.19	-08	95,5	3.76	57,2	2.25	9,9	.39	12,7	.50
12S	38,1	1.50	-12	107,2	4.22	62,0	2.44	15,5	.61	12,7	.50
16-12S	44,5	1.75	-12	109,7	4.32	62,0	2.44	15,5	.61	12,7	.50
16S	44,5	1.75	-16	122,9	4.84	70,9	2.79	20,8	.82	12,7	.50
20-16S	50,8	2.00	-16	122,9	4.84	70,9	2.79	20,8	.82	12,7	.50
20S	50,8	2.00	-20	139,4	5.49	80,5	3.17	26,7	1.05	12,7	.50
24S	60,5	2.38	-24	140,2	5.52	83,3	3.28	32,5	1.28	12,7	.50
32S	71,4	2.81	-32	153,4	6.04	91,4	3.60	44,5	1.75	12,7	.50

Code 61 SAE J518 30° Split Flange

190414-

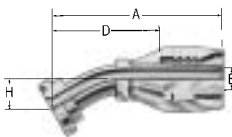

Dash Size	Flange Head Dia.		Hose Size	A		D		EØ		H	
	mm	in		mm	in	mm	in	mm	in		
190414-											
12S	38,1	1.50	-12	111,3	4.38	63,8	2.51	15,5	.61	17,5	.69
16-12S	44,5	1.75	-12	111,3	4.38	63,8	2.51	15,5	.61	17,5	.69
20-12S	50,8	2.00	-12	111,3	4.38	63,8	2.51	15,5	.61	17,5	.69
16S	44,5	1.75	-16	117,1	4.61	65,0	2.56	20,8	.82	12,7	.50
20-16S	50,8	2.00	-16	117,1	4.61	65,0	2.56	20,8	.82	12,7	.50
16-20S	44,5	1.75	-20	153,9	6.06	95,0	3.74	26,7	1.05	24,4	.96
20S	50,8	2.00	-20	153,9	6.06	95,0	3.74	26,7	1.05	24,4	.96
24-20S	60,5	2.38	-20	153,9	6.06	95,0	3.74	26,7	1.05	24,4	.96
32-20S	71,4	2.81	-20	155,4	6.12	96,5	3.80	26,7	1.05	25,1	.99
20-24S	50,8	2.00	-24	153,4	6.04	96,7	3.81	26,7	1.05	24,4	.96
24S	60,5	2.38	-24	138,4	5.45	81,8	3.22	32,5	1.28	14,7	.58
32-24S	71,4	2.81	-24	138,4	5.45	81,8	3.22	32,5	1.28	14,7	.58
32S	71,4	2.81	-32	155,7	6.13	93,7	3.69	44,5	1.75	16,5	.65

NOTE: For flanges, split flange halves, kits and o-rings, see pages 190-195.

NOTE: For socket part numbers, see page 65.

¹SAE 100R2 pressures only.

SPECIALTY &
TRUCK HOSE

LOW & MEDIUM
PRESSURE HOSE

HIGH PRESSURE HOSE

HOSE FITTINGS

ADAPTERS &
TUBE FITTINGS

ACCESSORIES &
ASSEMBLY INSTRUCTIONS

HOSE ASSEMBLY
EQUIPMENT

APPENDICES

Reusable Fittings

100R2 Skive Style

For use with Hose:

2766, 2781¹, FC195¹

Code 61 SAE J518 45° Split Flange

4745-

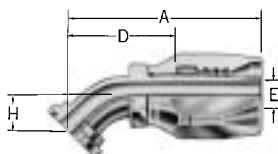

Dash Size	Flange Head Dia.		Hose Size	A		D		EØ		H	
	mm	in		mm	in	mm	in	mm	in	mm	in
4745-											
8S	30,2	1.19	-08	94,2	3.71	55,9	2.20	9,9	.39	25,4	1.00
12-8S	38,1	1.50	-08	94,2	3.71	55,9	2.20	9,9	.39	25,4	1.00
16-10S	44,5	1.75	-10	99,3	3.91	59,7	2.35	12,7	.50	25,4	1.00
12S	38,1	1.50	-12	110,2	4.34	62,7	2.47	15,5	.61	25,4	1.00
16-12S	44,5	1.75	-12	111,5	4.39	64,0	2.52	15,5	.61	25,4	1.00
20-12S	50,8	2.00	-12	111,3	4.38	64,0	2.52	15,5	.61	25,4	1.00
24-12S	60,5	2.38	-12	113,0	4.45	65,0	2.56	15,5	.61	26,7	1.05
32-12S	71,4	2.81	-12	111,0	4.37	63,5	2.50	15,5	.61	25,1	.99
16S	44,5	1.75	-16	129,3	5.09	77,2	3.04	20,8	.82	28,4	1.12
20-16S	50,8	2.00	-16	129,3	5.09	77,2	3.04	20,8	.82	28,4	1.12
24-16S	60,5	2.38	-16	130,3	5.13	78,2	3.08	20,8	.82	29,7	1.17
16-20S	44,5	1.75	-20	144,3	5.68	85,3	3.36	20,8	.82	28,4	1.12
20S	50,8	2.00	-20	146,8	5.78	87,9	3.46	26,7	1.05	28,4	1.12
24-20S	60,5	2.38	-20	146,8	5.78	87,9	3.46	26,7	1.05	28,4	1.12
32-20S	71,4	2.81	-20	148,1	5.83	89,2	3.51	26,7	1.05	29,7	1.17
20-24S	50,8	2.00	-24	146,3	5.76	89,7	3.53	26,7	1.05	28,4	1.12
24S	60,5	2.38	-24	149,1	5.87	92,2	3.63	32,5	1.28	28,4	1.12
32-24S	71,4	2.81	-24	148,8	5.86	92,2	3.63	32,5	1.28	28,4	1.12
32S	71,4	2.81	-32	168,4	6.63	106,4	4.19	44,5	1.75	31,8	1.25
40-32S	84,1	3.31	-32	169,4	6.67	107,4	4.23	44,5	1.75	33,0	1.30

Code 61 SAE J518 67¹/₂° Split Flange

4767-

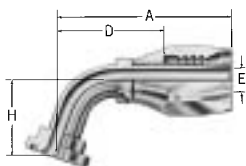

Dash Size	Flange Head Dia.		Hose Size	A		D		EØ		H	
	mm	in		mm	in	mm	in	mm	in	mm	in
4767-											
8S	30,2	1.19	-08	88,1	3.47	49,8	1.96	9,9	.39	35,1	1.38
12S	38,1	1.50	-12	111,0	4.37	63,5	2.50	15,5	.61	41,1	1.62
16-12S	44,5	1.75	-12	111,0	4.37	63,5	2.50	15,5	.61	41,1	1.62
16S	44,5	1.75	-16	128,7	5.07	76,7	3.02	20,8	.82	44,5	1.75
20-16S	50,8	2.00	-16	128,7	5.07	76,7	3.02	20,8	.82	44,5	1.75
20S	50,8	2.00	-20	149,4	5.88	90,4	3.56	26,7	1.05	47,8	1.88
24S	60,5	2.38	-24	154,4	6.08	97,5	3.84	32,5	1.28	50,8	2.00
32S	71,4	2.81	-32	176,3	6.94	114,3	4.50	44,5	1.75	57,2	2.25

NOTE: For flanges, split flange halves, kits and o-rings, see pages 190-195.

NOTE: For socket part numbers, see page 65.

¹SAE 100R2 pressures only.

Reusable Fittings

100R2 Skive Style

For use with Hose:

2766, 2781¹, FC195¹

Code 61 SAE J518 90° Split Flange

4790-

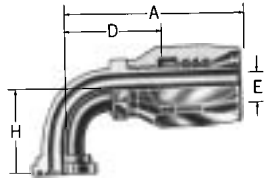

Dash Size	Thread		Hose Size	A		D		EØ		H	
	mm	in		mm	in	mm	in	mm	in	mm	in
4790-											
8S	30,2	1.19	-08	80,0	3.15	41,7	1.64	9,9	.39	41,1	1.62
12-8S	38,1	1.50	-08	80,0	3.15	41,7	1.64	9,9	.39	41,1	1.62
16-8S	44,5	1.75	-08	80,0	3.15	41,7	1.64	9,9	.39	45,2	1.78
12-10S	38,1	1.50	-10	88,9	3.50	49,3	1.94	12,7	.50	51,6	2.03
16-10S	44,5	1.75	-10	88,9	3.50	49,3	1.94	12,7	.50	53,8	2.12
8-12S	30,2	1.19	-12	91,7	3.61	44,2	1.74	9,4	.37	41,1	1.62
12S	38,1	1.50	-12	104,4	4.11	56,9	2.24	15,5	.61	53,8	2.12
16-12S	44,5	1.75	-12	104,4	4.11	56,9	2.24	15,5	.61	53,8	2.12
20-12S	50,8	2.00	-12	104,4	4.11	56,9	2.24	15,5	.61	53,8	2.12
24-12S	60,5	2.38	-12	104,4	4.11	56,9	2.24	15,5	.61	56,4	2.22
12-16S	38,1	1.50	-16	116,6	4.59	64,5	2.54	20,8	.82	53,8	2.12
16S	44,5	1.75	-16	122,9	4.84	70,9	2.79	20,8	.82	60,5	2.38
20-16S	50,8	2.00	-16	122,9	4.84	70,9	2.79	20,8	.82	60,5	2.38
24-16S	60,5	2.38	-16	122,9	4.84	70,9	2.79	20,8	.82	62,0	2.44
32-16S	71,4	2.81	-16	122,9	4.84	70,9	2.79	20,8	.82	59,4	2.34
16-20S	44,5	1.75	-20	138,2	5.44	79,2	3.12	20,8	.82	60,5	2.38
20S	50,8	2.00	-20	144,3	5.68	85,3	3.36	26,7	1.05	63,5	2.50
24-20S	60,5	2.38	-20	144,3	5.68	85,3	3.36	26,7	1.05	63,5	2.50
32-20S	71,4	2.81	-20	144,3	5.68	85,3	3.36	26,7	1.05	65,0	2.56
20-24S	50,8	2.00	-24	143,8	5.66	86,9	3.42	26,7	1.05	63,5	2.50
24S	60,5	2.38	-24	150,1	5.91	93,5	3.68	32,5	1.28	69,9	2.75
32-24S	71,4	2.81	-24	150,1	5.91	93,5	3.68	32,5	1.28	69,9	2.75
32S	71,4	2.81	-32	173,7	6.84	111,8	4.40	44,5	1.75	82,6	3.25
40-32S	84,1	3.31	-32	173,7	6.84	111,8	4.40	44,5	1.75	84,1	3.31

ORS Swivel Straight

FJ9732-

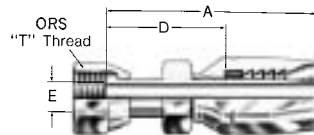

Dash Size	Thread		Hose Size	A		D		EØ	
	mm	in		mm	in	mm	in	mm	in
FJ9732-									
0404S	9/16-18		-04	69,9	2.75	38,6	1.52	4,3	.17
0606S	11/16-16		-06	76,7	3.02	39,4	1.55	6,6	.26
0808S	13/16-16		-08	86,4	3.40	48,0	1.89	9,9	.39
1010S	1-14		-10	90,9	3.58	51,6	2.03	12,7	.50
1212S	1 ³ /16-12		-12	102,9	4.05	55,4	2.18	15,5	.61
1616S	1 ⁷ /16-12		-16	121,4	4.78	69,3	2.73	20,8	.82
2020S	1 ¹¹ /16-12		-20	135,1	5.32	76,2	3.00	26,7	1.05
2424S	2-12		-24	135,9	5.35	79,2	3.12	32,0	1.26

ORS Swivel 45° Elbow

FJ9733-

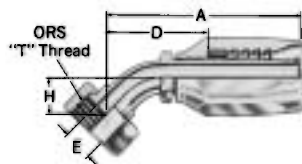

Dash Size	"T" Thread		Hose Size	A		D		EØ		H	
	mm	in		mm	in	mm	in	mm	in	mm	in
FJ9733-											
0404S	9/16-18		-04	66,5	2.62	35,3	1.39	3,8	.15	10,4	.41
0606S	11/16-16		-06	72,6	2.86	35,3	1.39	6,1	.24	10,9	.43
0808S	13/16-16		-08	83,8	3.30	45,5	1.79	9,4	.37	15,0	.59
1010S	1-14		-10	91,2	3.59	51,6	2.03	11,7	.46	16,5	.65
1212S	1 ³ /16-12		-12	106,9	4.21	59,4	2.34	14,7	.58	21,1	.83
1616S	1 ⁷ /16-12		-16	124,7	4.91	72,4	2.85	19,3	.76	23,9	.94
2020S	1 ¹¹ /16-12		-20	146,3	5.76	87,4	3.44	25,7	1.01	25,4	1.00
2424S	2-12		-24	147,6	5.81	90,9	3.58	32,0	1.26	27,2	1.07

NOTE: For flanges, split flange halves, kits and o-rings, see pages 190-195.

NOTE: For socket part numbers, see page 65.

¹SAE 100R2 pressures only.

Reusable Fittings

For use with Hose:

2766, 2781¹, FC195¹

100R2 Skive Style

ORS Swivel 90° Elbow Short Drop

FJ9734-

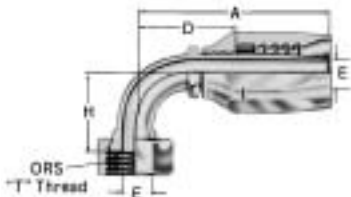

Dash Size	"T" Thread	Hose Size	A		D		EØ		H	
FJ9734-			mm	in	mm	in	mm	in	mm	in
0404S	9/16-18	-04	62,7	2.47	31,2	1.23	3,8	.15	20,8	.82
0606S	11/16-16	-06	69,1	2.72	31,8	1.25	6,1	.24	22,9	.90
0808S	13/16-16	-08	76,7	3.02	38,6	1.52	9,4	.37	29,2	1.15
1010S	1-14	-10	82,3	3.24	42,9	1.69	11,7	.46	32,3	1.27
1212S	13/16-12	-12	104,4	4.11	56,9	2.24	14,7	.58	47,8	1.88
1616S	17/16-12	-16	122,9	4.84	70,6	2.78	19,3	.76	56,1	2.21
2020S	11/16-12	-20	144,3	5.68	85,3	3.36	25,7	1.01	63,8	2.51
2424S	2-12	-24	150,1	5.91	93,5	3.68	32,0	1.26	68,6	2.70

ORS Swivel 90° Elbow Long Drop

FJ9735-

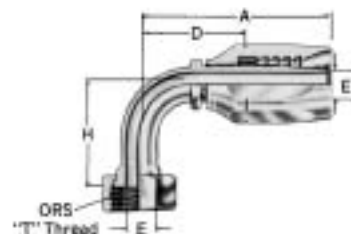

Dash Size	"T" Thread	Hose Size	A		D		EØ		H	
FJ9735-			mm	in	mm	in	mm	in	mm	in
0404S	9/16-18	-04	66,5	2.62	35,3	1.39	3,8	.15	45,7	1.80
0606S	11/16-16	-06	72,4	2.85	34,8	1.37	6,1	.24	54,1	2.13
0808S	13/16-16	-08	80,0	3.15	41,7	1.64	9,4	.37	63,8	2.51
1010S	1-14	-10	82,3	3.24	42,9	1.69	11,7	.46	70,1	2.76
1212S	13/16-12	-12	104,4	4.11	56,9	2.24	14,7	.58	96,0	3.78
1616S	17/16-12	-16	122,9	4.84	70,6	2.78	19,3	.76	114,3	4.50
2020S	11/16-12	-20	144,3	5.68	85,3	3.36	25,7	1.01	129,3	5.09
2424S	2-12	-24	150,1	5.91	93,5	3.68	32,0	1.26	140,7	5.54

BSP Male

07.020-

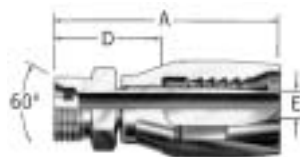

Dash Size	Thread	Hose Size	A		D		EØ	
07.020-			mm	in	mm	in	mm	in
4-4	1/4-19	-04	62.5	2.46	31	1.22	4.0	.16
6-6	3/8-19	-06	69	2.72	31.5	1.24	8.0	.31
8-8	1/2-14	-08	73	2.87	34.5	1.36	10.0	.39
10-10	5/8-14	-10	78.5	3.09	39	1.54	13.0	.51
12-10	3/4-14	-10	79.5	3.13	40	1.57	13.0	.51
12-12	3/4-14	-12	89	3.50	41.5	1.63	15.5	.61
16-12	1-11	-12	92.5	3.64	45	1.77	15.5	.61
16-16	1-11	-16	104.5	4.11	52.5	2.07	20.5	.81
20-20	1 1/4-11	-20	116.5	4.59	57.5	2.26	26.5	1.04
24-24	1 1/2-11	-24	115.5	4.55	58.5	2.30	32.5	1.28
32-32	2-11	-32	130.5	5.14	68.5	2.70	44.5	1.75

BSP Female Swivel

07.420-

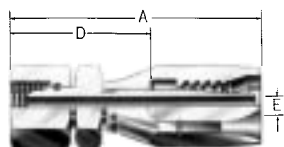

Dash Size	Thread	Hose Size	A		D		EØ	
07.420-			mm	in	mm	in	mm	in
4-4	1/4-19	-04	69	2.72	37.5	1.48	4.0	.16
6-6	3/8-19	-06	75.5	2.97	38	1.50	8.0	.31
8-6	1/2-14	-06	77	3.03	39.5	1.56	8.0	.31
8-8	1/2-14	-08	79	3.11	40.5	1.59	10.0	.39
10-8	5/8-14	-08	80.5	3.17	42	1.65	10.0	.39
10-10	5/8-14	-10	83	3.27	43.5	1.71	13.0	.51
12-10	3/4-14	-10	84.5	3.33	45	1.77	13.0	.51
12-12	3/4-14	-12	94	3.70	46.5	1.83	15.5	.61
16-12	1-11	-12	99	3.90	51.5	2.03	15.5	.61
16-16	1-11	-16	111	4.37	59	2.32	20.5	.81
20-16	1 1/4-11	-16	112	4.41	60	2.36	20.5	.81
20-20	1 1/4-11	-20	124	4.88	65	2.56	26.5	1.04
24-24	1 1/2-11	-24	125	4.92	68.5	2.70	32.5	1.28
32-32	2-11	-32	138	5.43	76.1	3.00	44.5	1.75

NOTE: For correct socket part number, see page 65.

Reusable Fittings

100R2 Skive Style

For use with Hose:

2766, 2781¹, FC195¹

Male 60° DIN 7631/7647

07.078-

For use with Hose:

2781, FC195

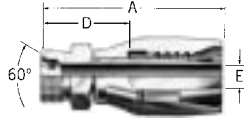

Dash Size	Thread	Hose Size	A		D		EØ	
			mm	in	mm	in	mm	in
07.078-			mm	in	mm	in	mm	in
4-4	M12 x 1.5	-04	61,0	2.40	29,5	1.16	4,0	.16
6-4	M14 x 1.5	-04	61,0	2.40	29,5	1.16	4,0	.16
8-6	M16 x 1.5	-06	66,0	2.60	28,5	1.12	8,0	.31
10-6	M18 x 1.5	-06	66,0	2.60	28,5	1.12	8,0	.31
13-8	M22 x 1.5	-08	70,0	2.76	31,5	1.24	10,0	.39
16-10	M26 x 1.5	-10	72,5	2.85	33,0	1.30	13,0	.51
20-12	M30 x 1.5	-12	84,0	3.31	36,5	1.44	15,5	.61
25-16	M38 x 1.5	-16	98,0	3.86	46,0	1.81	20,5	.81
32-20	M45 x 1.5	-20	110,0	4.33	51,0	2.01	26,5	1.04
40-24	M52 x 1.5	-24	110,0	4.33	53,0	2.09	32,5	1.28
50-32	M65 x 2	-32	122,0	4.80	60,0	2.36	44,5	1.75

Male 24° DIN 3901/3902 I.Rh

07.013-

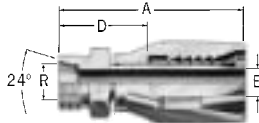

Dash Size	Thread	Hose Size	A		D		EØ		RØ	
			mm	in	mm	in	mm	in	mm	in
07.013-			mm	in	mm	in	mm	in	mm	in
6-4	M12 x 1.5	-04	61,0	2.40	29,5	1.16	4,0	.16	6,0	.24
8-4	M14 x 1.5	-04	61,0	2.40	29,5	1.16	4,0	.16	8,0	.31
10-6	M16 x 1.5	-06	67,0	2.64	29,5	1.16	8,0	.31	10,0	.39
12-6	M18 x 1.5	-06	77,0	2.64	29,5	1.16	8,0	.31	12,0	.47
15-8	M22 x 1.5	-08	70,0	2.76	31,5	1.24	10,0	.39	15,0	.59
18-10	M26 x 1.5	-10	72,5	2.85	33,0	1.30	13,0	.51	18,0	.71
22-12	M30 x 2	-12	86,0	3.39	38,5	1.52	15,5	.61	22,0	.87
28-16	M36 x 2	-16	98,0	3.86	46,0	1.81	20,5	.81	28,0	1.10
35-20	M45 x 2	-20	112,0	4.41	53,0	2.09	26,5	1.04	35,0	1.38
42-24	M52 x 2	-24	112,0	4.41	55,0	2.17	32,5	1.28	42,0	1.65

Male 24° DIN 3901/3902 s.Rh

07.005-

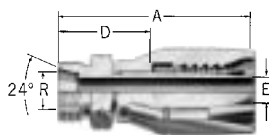

Dash Size	Thread	Hose Size	A		D		EØ		RØ	
			mm	in	mm	in	mm	in	mm	in
07.005-			mm	in	mm	in	mm	in	mm	in
8-4	M16 x 1.5	-04	63,0	2.48	31,5	1.24	4,0	.16	8,0	.31
10-4	M18 x 1.5	-04	63,0	2.48	31,5	1.24	4,0	.16	10,0	.39
12-6	M20 x 1.5	-06	68,0	2.68	30,5	1.20	8,0	.31	12,0	.47
14-6	M22 x 1.5	-06	70,0	2.76	32,5	1.28	8,0	.31	14,0	.55
16-8	M24 x 1.5	-08	70,0	2.83	33,5	1.32	10,0	.39	16,0	.63
20-10	M30 x 2	-10	72,0	3.09	39,0	1.54	13,0	.51	20,0	.79
25-12	M36 x 2	-12	90,0	3.54	42,5	1.67	15,5	.61	25,0	.98
30-16	M42 x 2	-16	104,0	4.09	52,0	2.05	20,5	.81	30,0	1.18
38-20	M52 x 2	-20	120,0	4.72	59,0	2.32	26,5	1.04	38,0	1.50

Female Swivel 60° DIN 7631/7647

07.357-

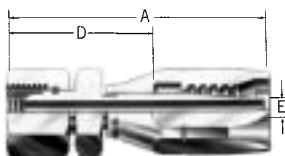

Dash Size	Thread	Hose Size	A		D		EØ	
			mm	in	mm	in	mm	in
07.357-			mm	in	mm	in	mm	in
20-12	M30 x 1.5	-12	93,5	3.68	46,0	1.81	15,5	.61
25-16	M38 x 1.5	-16	108,0	4.25	56,0	.20	20,5	.81
32-20	M45 x 1.5	-20	122,0	4.80	63,0	2.48	26,5	1.04
40-24	M52 x 1.5	-24	119,5	4.70	62,5	2.46	32,5	1.28
50-32	M65 x 2	-32	133,5	5.26	71,5	2.81	44,5	1.75

*Rf dimension is tube O.D. and refers to mating component when not called out on the illustration.
NOTE: For correct socket part number, see page 65.

¹SAE 100R2 pressures only.

SPECIALTY &
TRUCK HOSE

LOW & MEDIUM
PRESSURE HOSE

HIGH PRESSURE HOSE

HOSE FITTINGS

ADAPTERS &
TUBE FITTINGS

ACCESSORIES &
ASSEMBLY INSTRUCTIONS

HOSE ASSEMBLY
EQUIPMENT

APPENDICES

Reusable Fittings

100R2 Skive Style

For use with Hose:

2766, 2781¹, FC195¹

Female Swivel 24° DIN 3901/3902 I.Rh.

07.327-

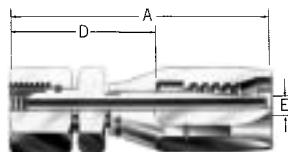

Dash Size	Thread	Hose Size	A	D	EØ	H
07.327-			mm in	mm in	mm in	mm in
4-4†	M12 x 1.5	-04	67,0 2.64	35,5 1.40	4,0 .16	6,0 .24
6-4†	M14 x 1.5	-04	67,0 2.64	35,5 1.40	4,0 .16	8,0 .31
8-6†	M16 x 1.5	-06	73,5 2.89	36,0 1.42	8,0 .31	10,0 .39
10-6†	M18 x 1.5	-06	73,5 2.89	36,0 1.42	8,0 .31	12,0 .47
13-8†	M22 x 1.5	-08	77,5 3.05	39,0 1.54	10,0 .39	15,0 .59
16-8†	M26 x 1.5	-08	80,5 3.17	42,0 1.65	10,0 .39	18,0 .71
16-10†	M26 x 1.5	-10	83,0 3.27	43,5 1.71	13,0 .51	18,0 .71
22-12	M30 x 2	-12	95,0 3.74	47,5 1.87	15,5 .61	22,0 .87
28-16	M36 x 2	-16	108,5 4.27	56,5 2.22	20,5 .81	28,0 1.10
35-20	M45 x 2	-20	121,5 4.78	62,5 2.46	26,5 1.04	35,0 1.38
42-24	M52 x 2	-24	122,0 4.80	65,0 2.56	32,5 1.28	42,0 1.65

Female Swivel 24° DIN 3901/3902 s.Rh.

07.721-

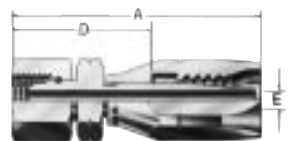

Dash Size	Thread	Hose Size	A	D	EØ	H
07.721-			mm in	mm in	mm in	mm in
8-4	M16 x 1.5	-04	68,5 2.70	37,0 1.46	4,0 .16	8,0 .31
10-4	M18 x 1.5	-04	68,5 2.70	37,0 1.46	4,0 .16	10,0 .39
12-6	M20 x 1.5	-06	75,5 2.97	38,0 1.50	8,0 .31	12,0 .47
14-6	M22 x 1.5	-06	75,5 2.97	38,0 1.50	8,0 .31	14,0 .55
16-8	M24 x 1.5	-08	79,5 3.13	41,0 1.61	10,0 .39	16,0 .63
20-10	M30 x 2	-10	85,5 3.37	46,0 1.81	13,0 .51	20,0 .79
20-12	M30 x 2	-12	95,0 3.74	47,5 1.87	15,5 .61	20,0 .79
25-12	M36 x 2	-12	96,0 3.78	48,5 1.91	15,5 .61	25,0 .98
30-16	M42 x 2	-16	109,0 4.29	57,0 2.24	20,5 .81	30,0 1.18
38-20	M52 x 2	-20	122,0 4.80	63,0 2.48	26,5 1.04	38,0 1.50

30° Swivel-Metric Threads Special Komatsu

FC5432-

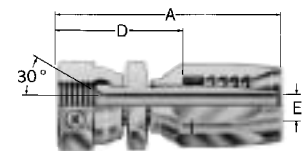

Dash Size	Thread	Hose Size	A	D	EØ
FC5432-			mm in	mm in	mm in
0306S	M18 x 1.5	-06	79,0 3.11	41,7 1.64	6,4 .25
0408S	M22 x 1.5	-08	84,3 3.32	45,7 1.80	9,4 .37
0510S	M24 x 1.5	-10	90,2 3.55	50,8 2.00	12,7 .50
0612S	M30 x 1.5	-12	103,6 4.08	56,1 2.21	15,5 .61
1016S	M33 x 1.5	-16	123,7 4.87	71,4 2.81	20,8 .82
1220S	M36 x 1.5	-20	139,2 5.48	80,0 3.15	24,1 .95
1424S	M42 x 1.5	-24	140,2 5.52	83,6 3.29	30,2 1.19

Komatsu Split Flange

FJ9066-

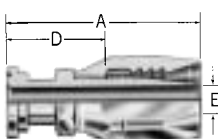

Dash Size	Thread	Hose Size	A	D	EØ
FJ9066-			mm in	mm in	mm in
1010S	34,3 1.35	-10	113,8 4.48	74,4 2.93	11,7 .46

Komatsu Split Flange 45° Elbow

FJ9065-

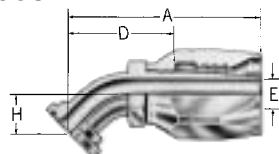

Dash Size	Thread	Hose Size	A	D	EØ	H
FJ9065-			mm in	mm in	mm in	mm in
1010S	34,3 1.35	-10	95,8 3.77	56,4 2.22	11,7 .46	21,8 .86

Komatsu Split Flange 90° Elbow

FJ9064-

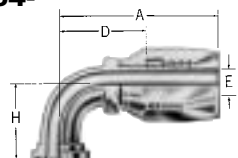

Dash Size	Thread	Hose Size	A	D	EØ	H
FJ9064-			mm in	mm in	mm in	mm in
1010S	34,3 1.35	-10	88,9 3.50	49,3 1.94	11,7 .46	51,3 2.02

[†]Universal fitting also mates with DIN 7631/7647 60° connection

*Rø dimension is tube O.D. and refers to mating component when not called out on the illustration.

NOTE: For correct socket part number, see page 65

¹SAE 100R2 pressures only.

Komatsu split flange fittings require the use of a special o-ring.

Reusable Fittings

100R2 TTC

For use with Hose:

FC212, GH793¹

Male Pipe

FC5985-

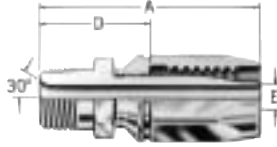

Dash Size	Thread	Hose Size	A		D		EØ	
			mm	in	mm	in	mm	in
FC5985-								
0404S	1/4-18	-04	63,5	2.50	33,8	1.33	4,3	.17
0606S	3/8-18	-06	69,9	2.75	35,8	1.41	7,9	.31
0608S	3/8-18	-08	72,1	2.84	33,3	1.31	9,9	.39
0808S	1/2-14	-08	74,5	3.09	40,1	1.58	9,9	.39
1212S	3/4-14	-12	91,7	3.61	44,2	1.74	15,5	.61
1616S	1-11 1/2	-16	111,8	4.40	59,7	2.35	20,8	.82

SAE 37° (JIC) Swivel

FC5988-

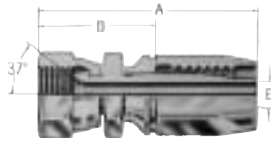

Dash Size	Thread	Hose Size	A		D		EØ	
			mm	in	mm	in	mm	in
FC5988-								
0404S	7/16-20	-04	67,1	2.64	37,3	1.47	4,3	.17
0606S	9/16-18	-06	75,7	2.98	41,7	1.64	7,9	.31
0808S	3/4-16	-08	81,3	3.20	42,7	1.68	9,9	.39
1212S	1 1/16-12	-12	98,0	3.86	50,5	1.99	15,5	.61
1616S	1 5/16-12	-16	113,8	4.48	61,7	2.43	20,8	.82

SAE 37° (JIC) Male Flare

FC5986-

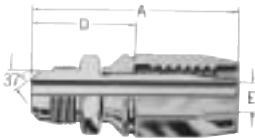

Dash Size	Thread	Hose Size	A		D		EØ	
			mm	in	mm	in	mm	in
FC5986-								
0404S	7/16-20	-04	63,2	2.49	33,5	1.32	4,3	.17
0606S	9/16-18	-06	69,9	2.75	35,8	1.41	7,6	.30
0808S	3/4-16	-08	75,9	2.99	37,6	1.48	9,9	.39
1212S	1 1/16-12	-12	94,5	3.72	47,0	1.85	15,5	.61
1616S	1 5/16-12	-16	111,3	4.38	59,2	2.33	20,8	.82

SAE Male O-Ring Boss**

FC5987-

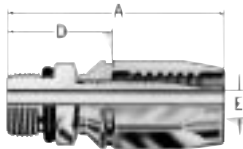

Dash Size	Thread	Hose Size	A		D		EØ	
			mm	in	mm	in	mm	in
FC5987-								
0606S	9/16-18	-06	65,5	2.58	31,5	1.24	7,9	.31
0806S	3/4-16	-06	66,8	2.63	32,8	1.29	7,9	.31
0808S	3/4-16	-08	68,8	2.71	30,5	1.20	9,9	.39
1212S	1 1/16-12	-12	87,9	3.46	40,3	1.59	15,5	.61
1616S	1 5/16-12	-16	99,8	3.93	47,8	1.88	20,8	.82

NOTE: For socket part numbers, see page 65.

¹SAE 100R2 pressures only.

** See pages 194, 195 for o-rings.

SPECIALTY & TRUCK HOSE

LOW & MEDIUM PRESSURE HOSE

HIGH PRESSURE HOSE

HOSE FITTINGS

ADAPTERS & TUBE FITTINGS

ACCESSORIES & ASSEMBLY INSTRUCTIONS

HOSE ASSEMBLY EQUIPMENT

APPENDICIES

Reusable Fittings

100R2 TTC

For use with Hose:

FC212, GH793¹

Lifesaver*

FC5989-

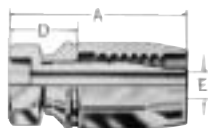

Dash Size	Tube Size	Hose Size	A		B*		D		EØ	
			mm	in	mm	in	mm	in	mm	in
FC5989-			mm	in	mm	in	mm	in	mm	in
0404S	1/4	-04	51,6	2.03	6,4	.25	21,8	.86	4,3	.17
0606S	3/8	-06	56,4	2.22	9,7	.38	22,4	.88	7,9	.31
0808S	1/2	-08	60,9	2.40	12,7	.50	22,6	.89	9,9	.39
1212S	3/4	-12	72,6	2.86	19,1	.75	25,1	.99	15,5	.61
1616S	1	-16	84,8	3.34	25,4	1.00	32,8	1.29	20,8	.82

*B dimension is counterbore diameter for mating tubing.

**SAE 37° (JIC) Swivel
45° Elbow**

FC5990-

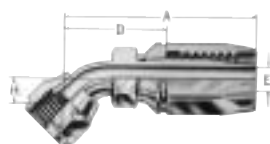

Dash Size	Thread	Hose Size	A		D		EØ		H	
			mm	in	mm	in	mm	in	mm	in
FC5990-			mm	in	mm	in	mm	in	mm	in
0404S	7/16-20	-04	63,8	2.51	34,0	1.34	4,3	.17	8,4	.33
0606S	9/16-18	-06	71,6	2.82	37,6	1.48	7,9	.31	9,9	.39
0808S	3/4-16	-08	82,8	3.26	44,5	1.75	9,9	.39	14,0	.55
1212S	1 1/16-12	-12	105,4	4.15	57,9	2.28	15,5	.61	19,8	.78
1616S	1 5/16-12	-16	127,8	5.03	75,7	2.98	20,8	.82	27,2	1.07

**SAE 37° (JIC) Swivel
90° Elbow (Short)**

FC5992-

90° Elbow (Long)

FC5991-

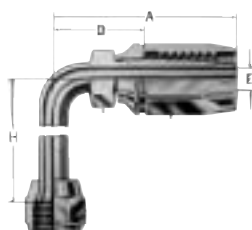

Dash Size	Thread	Hose Size	A		D		EØ		H	
			mm	in	mm	in	mm	in	mm	in
FC5992-			mm	in	mm	in	mm	in	mm	in
4-4										
0404S	7/16-20	-04	60,9	2.40	31,2	1.23	4,3	.17	17,3	.68
0606S	9/16-18	-06	69,1	2.72	35,1	1.38	7,9	.31	21,6	.85
0808S	3/4-16	-08	76,7	3.02	38,6	1.52	9,9	.39	27,7	1.09
1212S	1 1/16-12	-12	104,4	4.11	56,9	2.24	15,5	.61	46,2	1.82
1616S	1 5/16-12	-16	122,9	4.84	70,9	2.79	20,8	.82	60,7	2.39
FC5991-			mm	in	mm	in	mm	in	mm	in
0404S	7/16-20	-04	60,9	2.40	31,2	1.23	4,3	.17	45,7	1.80
0606S	9/16-18	-06	69,1	2.72	35,1	1.38	7,9	.31	55,4	2.18
0808S	3/4-16	-08	80,0	3.15	41,7	1.64	9,9	.39	61,7	2.43
1212S	1 1/16-12	-12	104,4	4.11	56,9	2.24	15,5	.61	94,7	3.73
1616S	1 5/16-12	-16	122,9	4.84	70,9	2.79	20,8	.82	116,3	4.58

**Code 61 SAE J518
Straight Split Flange**

FC5993-

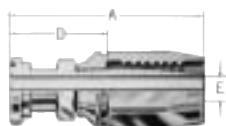

Dash Size	Flange Head Dia.	Hose Size	A		D		EØ	
	mm in		mm	in	mm	in	mm	in
FC5993-			mm	in	mm	in	mm	in
0808S	30,2 1.19	-08	77,0	3.03	38,6	1.52	9,9	.39
1212S	38,1 1.50	-12	89,7	3.53	42,2	1.66	15,5	.61
1616S	44,5 1.75	-16	118,1	4.65	66,0	2.60	20,8	.82

NOTE: For correct socket part number, see page 65.

NOTE: For flanges, split flange halves, kits and o-rings, see pages 190-195.

¹SAE 100R2 pressures only.

Reusable Fittings

100R2 TTC

For use with Hose:

FC212, GH793¹

ORS Swivel Straight FJ7344-

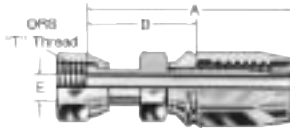

Dash Size	"T" Thread	Hose Size	A		D		EØ	
			mm	in	mm	in	mm	in
FJ7344-								
0404S	9/16-18	-04	70,1	2.76	40,3	1.59	4,1	.16
0606S	11/16-16	-06	77,0	3.03	42,9	1.69	6,6	.26
0808S	13/16-16	-08	86,4	3.40	48,0	1.89	9,1	.36
1212S	13/16-12	-12	103,1	4.06	59,9	2.36	14,0	.55
1616S	17/16-12	-16	121,7	4.79	69,6	2.74	19,8	.78

ORS Swivel 45° Elbow FJ7345-

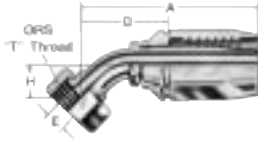

Dash Size	"T" Thread	Hose Size	A		D		EØ		H	
			mm	in	mm	in	mm	in	mm	in
FJ7345-										
0404S	9/16-18	-04	66,5	2.62	36,8	1.45	4,3	.17	10,4	.41
0606S	11/16-16	-06	72,9	2.87	38,9	1.53	6,6	.26	10,9	.43
0808S	13/16-16	-08	83,8	3.30	45,5	1.79	9,7	.38	15,0	.59
1212S	13/16-12	-12	106,9	4.21	59,4	2.34	15,5	.61	21,1	.83
1616S	17/16-12	-16	124,7	4.91	72,6	2.86	20,6	.81	23,9	.94

ORS Swivel 90° Elbow Short Drop FJ7346-

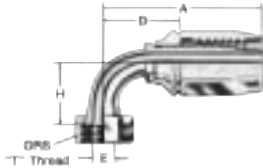

Dash Size	"T" Thread	Hose Size	A		D		EØ		H	
			mm	in	mm	in	mm	in	mm	in
FJ7346-										
0404S	9/16-18	-04	62,7	2.47	33,0	1.30	4,3	.17	20,8	.82
0606S	11/16-16	-06	69,1	2.72	35,1	1.38	6,6	.26	22,9	.90
0808S	13/16-16	-08	77,0	3.03	38,6	1.52	9,7	.38	29,2	1.15
1212S	13/16-12	-12	104,4	4.11	56,9	2.24	15,5	.61	47,8	1.88
1616S	17/16-12	-16	122,9	4.84	70,9	2.79	20,6	.81	56,1	2.21

ORS Swivel 90° Elbow Long Drop FJ7347-

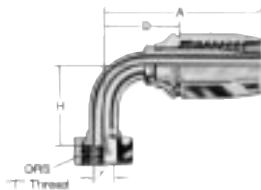

Dash Size	"T" Thread	Hose Size	A		D		EØ		H	
			mm	in	mm	in	mm	in	mm	in
FJ7347-										
0404S	9/16-18	-04	62,7	2.47	33,0	1.30	4,3	.17	45,7	1.80
0606S	11/16-16	-06	72,4	2.85	38,4	1.51	6,6	.26	54,1	2.13
0808S	13/16-16	-08	80,0	3.15	41,7	1.64	9,7	.38	63,8	2.51
1212S	13/16-12	-12	104,4	4.11	56,9	2.24	15,5	.61	96,0	3.78
1616S	17/16-12	-16	122,9	4.84	70,9	2.79	20,6	.81	114,3	4.50

NOTE: For socket part number, see page 65.

¹SAE 100R2 pressures only.

SPECIALTY &
TRUCK HOSE

LOW & MEDIUM
PRESSURE HOSE

HIGH PRESSURE HOSE

HOSE FITTINGS

ADAPTERS &
TUBE FITTINGS

ACCESSORIES &
ASSEMBLY INSTRUCTIONS

HOSE ASSEMBLY
EQUIPMENT

APPENDICES

Reusable Fittings

100R2 TTC

For use with Hose:

FC212, GH793¹

30° Swivel-Metric Threads Special Komatsu FJ7200-

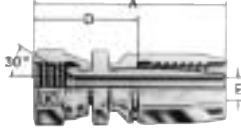

Dash Size	"T" Thread	Hose Size	A		D		EØ	
			mm	in	mm	in	mm	in
FJ7200-								
0306S	M18x1.5	-06	79,0	3.11	45,0	1.77	6,4	.25
0408S	M22x1.5	-08	84,3	3.32	45,7	1.80	9,4	.37
0512S	M24x1.5	-12	99,6	3.92	52,3	2.06	12,2	.48
0612S	M30x1.5	-12	103,6	4.08	56,4	2.22	15,5	.61
1016S	M33x1.5	-16	123,4	4.86	71,6	2.82	20,3	.80

¹SAE 100R2 pressures only.

SPECIALTY &
TRUCK HOSE

LOW & MEDIUM
PRESSURE HOSE

HIGH PRESSURE HOSE

HOSE FITTINGS

ADAPTERS &
TUBE FITTINGS

ACCESSORIES &
ASSEMBLY INSTRUCTIONS

HOSE ASSEMBLY
EQUIPMENT

APPENDICES

Reusable Fittings

Spiral Skive Style

For use with Hose:

FC136, FC324 (-08), GH493,
FC736

Male Pipe

**190934-
FC7640-**

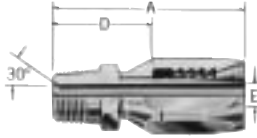

Dash Size	Thread	Hose Size	A		D		EØ	
190934-			mm	in	mm	in	mm	in
4-6S	1/4-18	-06	78,0	3.07	36,8	1.45	7,6	.30
6-6S	3/8-18	-06	78,0	3.07	36,8	1.45	7,6	.30
6-8S	3/8-18	-08	72,1	2.84	33,8	1.33	9,9	.39
8-8S	1/2-14	-08	74,5	3.09	40,1	1.58	9,9	.39
12-12S	3/4-14	-12	91,7	3.61	44,2	1.74	15,5	.61
16-16S	1-11 1/2	-16	111,8	4.40	59,7	2.35	20,8	.82
FC7640-			mm	in	mm	in	mm	in
2020S	1 1/4-11 1/2	-20	138,2	5.44	62,0	2.44	26,7	1.05
2424S	1 1/2-11 1/2	-24	146,3	5.76	71,6	2.82	32,5	1.28

SAE 37° (JIC) Swivel

**190933-
FC7639-**

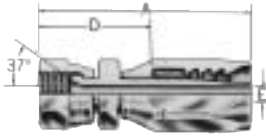

Dash Size	Thread	Hose Size	A		D		EØ	
190933-			mm	in	mm	in	mm	in
6-6S	9/16-18	-06	83,8	3.30	42,7	1.68	7,6	.30
8-6S	3/4-16	-06	87,1	3.43	46,0	1.81	7,6	.30
8-8S	3/4-16	-08	81,3	3.20	42,7	1.68	9,9	.39
10-8S	7/8-14	-08	84,1	3.31	45,7	1.80	9,9	.39
12S	1 1/16-12	-12	98,0	3.86	50,5	1.99	15,5	.61
16S	1 5/16-12	-16	113,8	4.48	61,7	2.43	20,8	.82
FC7639-			mm	in	mm	in	mm	in
2020S	1 5/8-12	-20	143,3	5.64	67,1	2.64	26,7	1.05
2424S	1 7/8-12	-24	154,4	6.08	79,5	3.13	32,5	1.28

SAE 37° (JIC) Male Flare

**190992-
FC7740-**

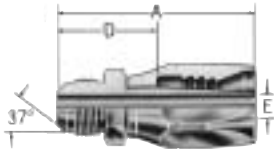

Dash Size	Thread	Hose Size	A		D		EØ	
190992-			mm	in	mm	in	mm	in
8-8S	3/4-16	-08	75,9	2.99	37,6	1.48	9,9	.39
10-8S	7/8-14	-08	78,7	3.10	40,1	1.58	9,9	.39
12S	1 1/16-12	-12	94,5	3.72	47,0	1.85	15,5	.61
16S	1 5/16-12	-16	111,3	4.38	59,2	2.33	20,8	.82
FC7740-			mm	in	mm	in	mm	in
2020S	1 5/8-12	-20	137,9	5.43	61,7	2.43	26,7	1.05
2424S	1 7/8-12	-24	148,6	5.85	73,7	2.90	32,5	1.28

SAE 37° (JIC) swivel 22 1/2° elbow

**FC5978-
FC5979-**

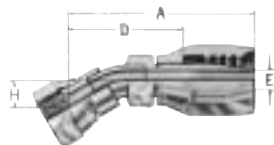

Dash Size	Thread	Hose Size	A		D		EØ		H
FC5978-			mm	in	mm	in	mm	in	mm
0808S	3/4-16	-08	102,4	4.03	64,0	2.52	9,9	.39	11,9
1212S	1 1/16-12	-12	119,9	4.72	72,4	2.85	15,5	.61	13,2
1616S	1 5/16-12	-16	147,1	5.79	95,0	3.74	20,8	.82	17,5
FC5979-			mm	in	mm	in	mm	in	mm
2020S	1 5/8-12	-20	185,9	7.32	109,7	4.32	26,7	1.05	20,3
2424S	1 7/8-12	-24	211,3	8.32	136,4	5.37	32,5	1.28	24,1

NOTE: For socket part numbers, see page 65.

SPECIALTY &
TRUCK HOSE

LOW & MEDIUM
PRESSURE HOSE

HIGH PRESSURE HOSE

HOSE FITTINGS

ADAPTERS &
TUBE FITTINGS

ACCESSORIES &
ASSEMBLY INSTRUCTIONS

HOSE ASSEMBLY
EQUIPMENT

APPENDICES

Reusable Fittings

Spiral Skive Style

For use with Hose:

FC136, FC324 (-08), GH493,
FC736

SAE 37° (JIC) Swivel 30° Elbow

FC5980-
FC5981-

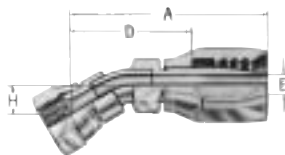

Dash Size	Thread	Hose Size	A		D		EØ		H	
FC5980-			mm	in	mm	in	mm	in	mm	in
0808S	3/4-16	-08	101,1	3.98	62,7	2.47	9,9	.39	15,7	.62
1212S	1 1/16-12	-12	118,1	4.65	70,6	2.78	15,5	.61	17,5	.69
1616S	1 5/16-12	-16	148,8	5.86	96,5	3.80	20,8	.82	24,1	.95
FC5981-			mm	in	mm	in	mm	in	mm	in
2020S	1 5/8-12	-20	189,5	7.46	113,3	4.46	26,7	1.05	28,2	1.11
2424S	1 7/8-12	-24	213,1	8.39	138,2	5.44	32,5	1.28	32,8	1.29

SAE 37° (JIC) Swivel 45° Elbow

FC5982-
FC5983-

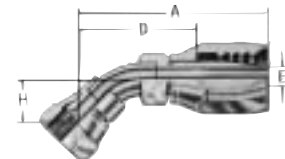

Dash Size	Thread	Hose Size	A		D		EØ		H	
FC5982-			mm	in	mm	in	mm	in	mm	in
0808S	3/4-16	-08	100,3	3.95	62,0	2.44	9,9	.39	24,1	.95
1212S	1 1/16-12	-12	123,7	4.87	76,2	3.00	15,5	.61	29,5	1.16
1616S	1 5/16-12	-16	152,4	6.00	100,1	3.94	20,8	.82	38,9	1.53
FC5983-			mm	in	mm	in	mm	in	mm	in
2020S	1 5/8-12	-20	188,5	7.42	112,2	4.42	26,7	1.05	43,8	1.70
2424S	1 7/8-12	-24	212,9	8.38	137,9	5.43	32,5	1.28	50,5	1.99

SAE 37° (JIC) Swivel 60° Elbow

FC5984-
FJ9024-

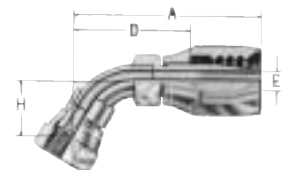

Dash Size	Thread	Hose Size	A		D		EØ		H	
FC5984-			mm	in	mm	in	mm	in	mm	in
0808S	3/4-16	-08	97,5	3.84	59,2	2.33	9,9	.39	32,0	1.26
1212S	1 1/16-12	-12	123,2	4.85	75,7	2.98	15,5	.61	40,6	1.60
1616S	1 5/16-12	-16	149,9	5.90	97,5	3.84	20,8	.82	52,8	2.08
FJ9024-			mm	in	mm	in	mm	in	mm	in
2020S	1 5/8-12	-20	186,9	7.36	110,7	4.36	26,7	1.05	59,2	2.33
2424S	1 7/8-12	-24	210,1	8.27	135,1	5.32	32,5	1.28	68,8	2.71

SAE 37° (JIC) Swivel 67 1/2° Elbow

FJ9025-
FJ9026-

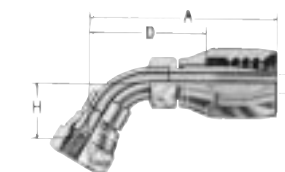

Dash Size	Thread	Hose Size	A		D		EØ		H	
FJ9025-			mm	in	mm	in	mm	in	mm	in
0808S	3/4-16	-08	98,0	3.86	59,7	2.35	9,9	.39	37,3	1.47
1212S	1 1/16-12	-12	121,4	4.78	73,9	2.91	15,5	.61	45,7	1.80
1616S	1 5/16-12	-16	148,3	5.84	96,0	3.78	20,8	.82	59,9	2.36
FJ9026-			mm	in	mm	in	mm	in	mm	in
2020S	1 5/8-12	-20	183,9	7.24	107,7	4.24	26,7	1.05	66,5	2.62
2424S	1 7/8-12	-24	195,6	7.70	120,7	4.75	32,5	1.28	70,1	2.76

NOTE: For socket part numbers, see page 65.

Reusable Fittings

Spiral Skive Style

For use with Hose:

FC136, FC324 (-08), GH493,
FC736

SAE 37° (JIC) Swivel 90° Elbow

FJ9027-
FJ9028-

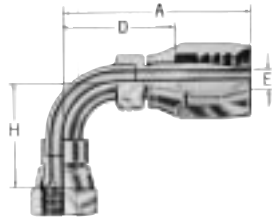

Dash Size	Thread	Hose Size	A		D		EØ		H	
			mm	in	mm	in	mm	in	mm	in
FJ9027-										
0808S	3/4-16	-08	89,4	3.52	51,3	2.02	9,9	.39	47,5	1.87
1212S	1 1/16-12	-12	112,5	4.43	65,0	2.56	15,5	.61	59,7	2.35
1616S	1 5/16-12	-16	135,6	5.34	83,3	3.28	20,8	.82	77,2	3.04
FJ9028-										
2020S	1 5/8-12	-20	170,7	6.72	94,5	3.72	26,7	1.05	86,4	3.40
2424S	1 7/8-12	-24	191,0	7.52	115,8	4.56	32,5	1.28	100,3	3.95

Straight Split Flange

Code 61 SAE J518

190935-
FC7713-

Code 62 SAE J518

FC7370-
FC5973-

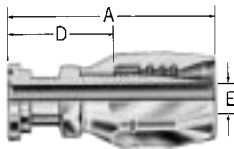

Dash Size	Flange Head Dia.		Hose Size	A		D		EØ	
	mm	in		mm	in	mm	in	mm	in
190935-									
8S	30,2	1.19	-08	102,9	4.05	64,5	2.54	9,4	.37
12-8S	38,1	1.50	-08	102,9	4.05	64,5	2.54	9,4	.37
12S	38,1	1.50	-12	121,7	4.79	74,2	2.92	14,2	.56
16-12S	44,5	1.75	-12	121,7	4.79	74,2	2.92	14,2	.56
16S	44,5	1.75	-16	144,5	5.69	92,2	3.63	20,6	.81
20-16S	50,8	2.00	-16	144,5	5.69	92,2	3.63	20,6	.81
FC7713-									
2020S	50,8	2.00	-20	174,2	6.86	98,0	3.86	26,7	1.05
2420S	60,5	2.38	-20	174,2	6.86	98,0	3.86	26,7	1.05
2424S	60,5	2.38	-24	199,6	7.86	124,5	4.90	32,5	1.28
3224S	71,4	2.81	-24	199,6	7.86	124,5	4.90	32,5	1.28
FC7370-									
1208S	41,1	1.62	-08	102,9	4.05	64,5	2.54	9,4	.37
1212S	41,1	1.62	-12	121,7	4.79	74,2	2.92	14,2	.56
1612S	47,8	1.88	-12	121,7	4.79	74,2	2.92	14,2	.56
1616S	47,8	1.88	-16	144,5	5.69	92,2	3.63	20,6	.81
2016S	53,8	2.12	-16	144,5	5.69	92,2	3.63	20,6	.81
FC5973-									
2020S	53,8	2.12	-20	174,2	6.86	97,8	3.85	26,7	1.05
2420S	63,5	2.50	-20	174,2	6.86	97,8	3.85	26,7	1.05
2424S	63,5	2.50	-24	199,6	7.86	124,5	4.90	32,5	1.28
3224S	mm	3.12	-24	199,6	7.86	124,5	4.90	32,5	1.28

NOTE: For flanges, split flange halves, kits and o-rings, see pages 190-195.

NOTE: For socket part numbers, see page 65.

SPECIALTY &
TRUCK HOSE

LOW & MEDIUM
PRESSURE HOSE

HIGH PRESSURE HOSE

HOSE FITTINGS

ADAPTERS &
TUBE FITTINGS

ACCESSORIES &
ASSEMBLY INSTRUCTIONS

HOSE ASSEMBLY
EQUIPMENT

APPENDICES

Reusable Fittings

Spiral Skive Style

For use with Hose:

FC136, FC324 (-08), GH493,
FC736

22 1/2° Split Flange

Code 61 SAE J518

FC9634-

FC7714-

Code 62 SAE J518

FC7983-

FC5974-

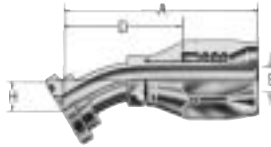

Dash Size	Flange Head Dia.		Hose Size	A		D		EØ		H	
	mm	in		mm	in	mm	in	mm	in	mm	in
FC9634-											
0808S	30,2	1.19	-08	96,7	3.81	58,4	2.30	9,9	.39	9,7	.38
1208S	38,1	1.50	-08	96,7	3.81	58,4	2.30	9,9	.39	9,7	.38
1212S	38,1	1.50	-12	114,6	4.51	67,1	2.64	15,5	.61	11,2	.44
1612S	44,5	1.75	-12	114,6	4.51	67,1	2.64	15,5	.61	11,2	.44
1616S	44,5	1.75	-16	131,6	5.18	79,2	3.12	20,8	.82	11,2	.44
2016S	50,8	2.00	-16	131,6	5.18	79,2	3.12	20,8	.82	11,2	.44
FC7714-											
2020S	50,8	2.00	-20	167,9	6.61	91,7	3.61	26,7	1.05	12,7	.50
2420S	60,5	2.38	-20	167,9	6.61	91,7	3.61	26,7	1.05	12,7	.50
2424S	60,5	2.38	-24	192,0	7.56	117,1	4.61	32,5	1.28	16,0	.63
3224S	71,4	2.81	-24	192,0	7.56	117,1	4.61	32,5	1.28	16,0	.63
FC7983-											
1208S	41,1	1.62	-08	96,7	3.81	58,4	2.30	9,9	.39	9,7	.38
1212S	41,1	1.62	-12	114,6	4.51	67,1	2.64	15,5	.61	11,2	.44
1612S	47,8	1.88	-12	114,6	4.51	67,1	2.64	15,5	.61	11,2	.44
1616S	47,8	1.88	-16	131,6	5.18	79,2	3.12	20,8	.82	11,2	.44
2016S	53,8	2.12	-16	131,6	5.18	79,2	3.12	20,8	.82	11,2	.44
FC5974-											
2020S	53,8	2.12	-20	167,9	6.61	91,7	3.61	26,7	1.05	12,7	.50
2420S	63,5	2.50	-20	167,9	6.61	91,7	3.61	26,7	1.05	12,7	.50
2424S	63,5	2.50	-24	192,0	7.56	117,1	4.61	32,5	1.28	16,0	.63
3224S	79,2	3.12	-24	192,0	7.56	117,1	4.61	57,9	2.28	16,0	.63

30° Split Flange

Code 61 SAE J518

FC9459-

FC7790-

Code 62 SAE J518

FC7371-

FC5975-

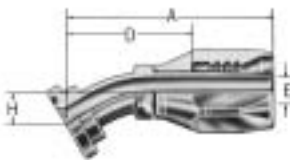

Dash Size	Flange Head Dia.		Hose Size	A		D		EØ		H	
	mm	in		mm	in	mm	in	mm	in	mm	in
FC9459-											
0808S	30,2	1.19	-08	95,8	3.77	57,4	2.26	9,9	.39	12,7	.50
1208S	38,1	1.50	-08	95,8	3.77	57,4	2.26	9,9	.39	12,7	.50
1212S	38,1	1.50	-12	113,3	4.46	65,8	2.59	15,5	.61	14,7	.58
1612S	44,5	1.75	-12	113,3	4.46	65,8	2.59	15,5	.61	14,7	.58
1616S	44,5	1.75	-16	134,1	5.28	81,8	3.22	20,8	.82	15,7	.62
2016S	50,8	2.00	-16	134,1	5.28	81,8	3.22	20,8	.82	15,7	.62
FC7790-											
2020S	50,8	2.00	-20	172,2	6.78	96,0	3.78	26,7	1.05	18,3	.72
2420S	60,5	2.38	-20	172,2	6.78	96,0	3.78	26,7	1.05	18,3	.72
2424S	60,5	2.38	-24	195,1	7.68	120,1	4.73	32,5	1.28	22,4	.88
3224S	71,4	2.81	-24	195,1	7.68	120,1	4.73	32,5	1.28	22,4	.88
FC7371-											
1208S	41,1	1.62	-08	95,8	3.77	57,4	2.26	9,9	.39	12,7	.50
1212S	41,1	1.62	-12	113,3	4.46	65,8	2.59	15,5	.61	14,7	.58
1612S	47,8	1.88	-12	113,3	4.46	65,8	2.59	15,5	.61	14,7	.58
1616S	47,8	1.88	-16	134,1	5.28	81,8	3.22	20,8	.82	15,7	.62
2016S	53,8	2.12	-16	134,1	5.28	81,8	3.22	20,8	.82	15,7	.62
FC5975-											
2020S	53,8	2.12	-20	172,2	6.78	96,0	3.78	26,7	1.05	18,3	.72
2420S	63,5	2.50	-20	172,2	6.78	96,0	3.78	26,7	1.05	18,3	.72
2424S	63,5	2.50	-24	195,1	7.68	120,1	4.73	32,5	1.28	22,4	.88
3224S	79,2	3.12	-24	195,1	7.68	120,1	4.73	32,5	1.28	22,4	.88

NOTE: For correct socket part number, see page 65.

NOTE: For flanges, split flange halves, kits and o-rings, see pages 190-195.

Reusable Fittings

Spiral Skive Style

For use with Hose:

FC136, FC324 (-08), GH493,
FC736

45° Split Flange

Code 61 SAE J518

190936-

FC7715-

Code 62 SAE J518

FC7372-

FC5976-

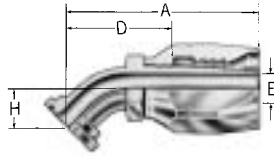

Dash Size	Flange Head Dia.		Hose Size	A		D		EØ		H	
	mm	in		mm	in	mm	in	mm	in	mm	in
190936-											
8S	30,2	1.19	-08	96,0	3.78	57,7	2.27	9,4	.37	19,8	.78
12-8S	38,1	1.50	-08	96,0	3.78	57,7	2.27	9,4	.37	19,8	.78
12S	38,1	1.50	-12	119,6	4.71	72,1	2.84	14,2	.56	25,4	1.00
16-12S	44,5	1.75	-12	119,6	4.71	72,1	2.84	14,2	.56	25,4	1.00
16S	44,5	1.75	-16	140,5	5.53	88,1	3.47	20,6	.81	26,9	1.06
20-16S	50,8	2.00	-16	140,5	5.53	88,1	3.47	20,6	.81	26,9	1.06
FC7715-											
1620S	44,5	1.75	-20	169,2	6.66	93,0	3.66	20,8	.82	26,9	1.06
2020S	50,8	2.00	-20	174,5	6.87	98,3	3.87	26,7	1.05	29,2	1.15
2420S	60,5	2.38	-20	174,5	6.87	98,3	3.87	26,7	1.05	29,2	1.15
2424S	60,5	2.38	-24	197,9	7.79	122,9	4.84	32,5	1.28	35,8	1.41
3224S	71,4	2.81	-24	197,9	7.79	122,9	4.84	32,5	1.28	35,8	1.41
FC7372-											
0808S	31,8	1.25	-08	96,0	3.78	57,7	2.27	9,4	.37	19,8	.78
1208S	41,1	1.62	-08	96,0	3.78	57,7	2.27	9,9	.39	19,8	.78
1212S	41,1	1.62	-12	119,6	4.71	72,1	2.84	15,5	.61	25,4	1.00
1612S	47,8	1.88	-12	119,6	4.71	72,1	2.84	15,5	.61	25,4	1.00
1616S	47,8	1.88	-16	140,5	5.53	88,1	3.47	20,8	.82	26,9	1.06
2016S	53,8	2.12	-16	140,5	5.53	88,1	3.47	20,8	.82	26,9	1.06
FC5976-											
2020S	53,8	2.12	-20	174,5	6.87	98,3	3.87	26,7	1.05	29,2	1.15
2420S	63,5	2.50	-20	174,5	6.87	98,3	3.87	26,7	1.05	29,2	1.15
2424S	63,5	2.50	-24	197,9	7.79	122,9	4.84	32,5	1.28	35,8	1.41
3224S	79,2	3.12	-24	197,9	7.79	122,9	4.84	32,5	1.28	35,8	1.41

60° Split Flange

Code 61 SAE J518

FC9066-/FC5060-

Code 62 SAE J518

FC7373-

FC5977-



Dash Size	Flange Head Dia.		Hose Size	A		D		EØ		H	
	mm	in		mm	in	mm	in	mm	in	mm	in
FC9066-											
0808S	30,2	1.19	-08	94,5	3.72	56,1	2.21	9,9	.39	26,7	1.05
1208S	38,1	1.50	-08	94,5	3.72	56,1	2.21	9,9	.39	26,7	1.05
1212S	38,1	1.50	-12	120,4	4.74	72,9	2.87	15,5	.61	35,8	1.41
1612S	44,5	1.75	-12	120,4	4.74	72,9	2.87	15,5	.61	35,8	1.41
1616S	44,5	1.75	-16	141,2	5.56	88,9	3.50	20,8	.82	38,1	1.50
2016S	50,8	2.00	-16	141,2	5.56	88,9	3.50	20,8	.82	38,1	1.50
FC5060-											
2020S	50,8	2.00	-20	177,0	6.97	100,8	3.97	26,7	1.05	42,2	1.66
2420S	60,5	2.38	-20	177,0	6.97	100,8	3.97	26,7	1.05	42,2	1.66
2024S	50,8	2.00	-24	184,7	7.27	109,7	4.32	26,7	1.05	42,2	1.66
2424S	60,5	2.38	-24	199,4	7.85	124,5	4.90	32,5	1.28	50,8	2.00
3224S	71,4	2.81	-24	199,4	7.85	124,5	4.90	32,5	1.28	50,8	2.00
FC7373-											
1208S	41,1	1.62	-08	94,5	3.72	56,1	2.21	9,9	.39	26,7	1.05
1212S	41,1	1.62	-12	120,4	4.74	72,9	2.87	15,5	.61	35,8	1.41
1612S	47,8	1.88	-12	120,4	4.74	72,9	2.87	15,5	.61	35,8	1.41
1616S	47,8	1.88	-16	141,2	5.56	88,9	3.50	20,8	.82	38,1	1.50
2016S	53,8	2.12	-16	141,2	5.56	88,9	3.50	20,8	.82	38,1	1.50
FC5977-											
2020S	53,8	2.12	-20	177,0	6.97	100,8	3.97	26,7	1.05	42,2	1.66
2420S	63,5	2.50	-20	177,0	6.97	100,8	3.97	26,7	1.05	42,2	1.66
2424S	63,5	2.50	-24	199,4	7.85	124,5	4.90	32,5	1.28	50,8	2.00
3224S	79,2	3.12	-24	199,4	7.85	124,5	4.90	32,5	1.28	50,8	2.00

NOTE: For flanges, split flange halves, kits and o-rings, see pages 190-195.

NOTE: For correct socket part number, see page 65.

Reusable Fittings

Spiral Skive Style

For use with Hose:

FC136, FC324 (-08), GH493, FC736

67¹/₂° Split Flange

Code 61 SAE J518

FC9118-

FC7811-

Code 62 SAE J518

FC7984-

FJ9034-

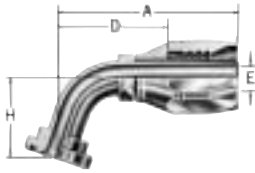

Dash Size	Flange Head Dia.		Hose Size	A		D		EØ		H	
	mm	in		mm	in	mm	in	mm	in	mm	in
FC9118-											
0808S	30,2	1.19	-08	95,8	3.77	57,4	2.26	9,9	.39	31,8	1.25
1208S	38,1	1.50	-08	95,8	3.77	57,4	2.26	9,9	.39	31,8	1.25
1212S	38,1	1.50	-12	119,1	4.69	71,6	2.82	15,5	.61	40,6	1.60
1612S	44,5	1.75	-12	119,1	4.69	71,6	2.82	15,5	.61	40,6	1.60
1616S	44,5	1.75	-16	141,7	5.58	89,7	3.53	20,8	.82	44,5	1.75
2016S	50,8	2.00	-16	141,7	5.58	89,7	3.53	20,8	.82	44,5	1.75
FC7811-											
2020S	50,8	2.00	-20	176,3	6.94	100,1	3.94	26,7	1.05	48,3	1.90
2420S	60,5	2.38	-20	176,3	6.94	100,1	3.94	26,7	1.05	48,3	1.90
2424S	60,5	2.38	-24	187,5	7.38	112,5	4.43	32,5	1.28	50,8	2.00
3224S	71,4	2.81	-24	187,5	7.38	112,5	4.43	32,5	1.28	50,8	2.00
FC7984-											
1208S	41,1	1.62	-08	95,8	3.77	57,4	2.26	9,9	.39	31,8	1.25
1212S	41,1	1.62	-12	119,1	4.69	71,6	2.82	5,5	.61	40,6	1.60
1612S	47,8	1.88	-12	119,1	4.69	71,6	2.82	15,5	.61	40,6	1.60
1616S	47,8	1.88	-16	141,7	5.58	89,7	3.53	20,8	.82	44,5	1.75
2016S	53,8	2.12	-16	141,7	5.58	89,7	3.53	20,8	.82	44,5	1.75
FC9034-											
2020S	53,8	2.12	-20	176,3	6.94	100,1	3.94	26,7	1.05	48,3	1.90
2420S	63,5	2.50	-20	176,3	6.94	100,1	3.94	26,7	1.05	48,3	1.90
2424S	63,5	2.50	-24	187,5	7.38	112,5	4.43	32,5	1.28	50,8	2.00
3224S	79,2	3.12	-24	187,5	7.38	112,5	4.43	32,5	1.28	50,8	2.00

90° Split Flange

Code 61 SAE J518

190937-

FC7703-

Code 62 SAE J518

FC7374-

FJ9033-

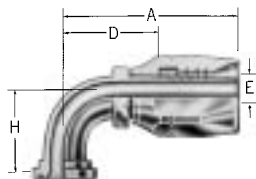

Dash Size	Flange Head Dia.		Hose Size	A		D		EØ		H	
	mm	in		mm	in	mm	in	mm	in	mm	in
190937-											
8S	30,2	1.19	-08	89,4	3.52	51,3	2.02	9,9	.39	41,1	1.62
12-8S	38,1	1.50	-08	89,4	3.52	51,3	2.02	9,9	.39	41,1	1.62
12S	38,1	1.50	-12	112,5	4.43	65,0	2.56	15,5	.61	54,1	2.13
16-12S	44,5	1.75	-12	112,5	4.43	65,0	2.56	15,5	.61	54,1	2.13
20-12S	50,8	2.00	-12	112,5	4.43	65,0	2.56	15,5	.61	54,1	2.13
16S	44,5	1.75	-16	135,6	5.34	83,3	3.28	20,8	.82	60,5	2.38
20-16S	50,8	2.00	-16	135,6	5.34	83,3	3.28	20,8	.82	60,5	2.38
24-16S	60,5	2.38	-16	135,6	5.34	83,3	3.28	20,8	.82	60,5	2.38
FC7703-											
2020S	50,8	2.00	-20	170,7	6.72	94,5	3.72	26,7	1.05	66,5	2.62
2420S	60,5	2.38	-20	170,7	6.72	94,5	3.72	26,7	1.05	66,5	2.62
2424S	60,5	2.38	-24	191,0	7.52	115,8	4.56	32,5	1.28	79,2	3.12
3224S	71,4	2.81	-24	191,0	7.52	115,8	4.56	32,5	1.28	79,2	3.12
FC7374-											
0808S	31,8	1.25	-08	89,4	3.52	51,3	2.02	9,9	.39	41,1	1.62
1208S	41,1	1.62	-08	89,4	3.52	51,3	2.02	9,9	.39	41,1	1.62
1212S	41,1	1.62	-12	112,5	4.43	65,0	2.56	15,5	.61	54,1	2.13
1612S	47,8	1.88	-12	112,5	4.43	65,0	2.56	15,5	.61	54,1	2.13
1616S	47,8	1.88	-16	135,6	5.34	83,3	3.28	20,8	.82	60,5	2.38
2016S	53,8	2.12	-16	135,6	5.34	83,3	3.28	20,8	.82	57,9	2.28
FJ9033-											
2020S	53,8	2.12	-20	170,7	6.72	94,5	3.72	26,7	1.05	66,5	2.62
2420S	63,5	2.50	-20	170,7	6.72	94,5	3.72	26,7	1.05	66,5	2.62
2424S	65,5	2.50	-24	191,0	7.52	115,8	4.56	32,5	1.28	79,2	3.12
3224S	79,2	3.12	-24	191,0	7.52	115,8	4.56	32,5	1.28	79,2	3.12

NOTE: For flanges, split flange halves, kits and o-rings, see pages 190-195.

NOTE: For correct socket part number, see page 65.

Reusable Fittings

Spiral Skive Style

For use with Hose:

FC136, FC324 (-08), GH493, FC736

ORS Swivel Straight

FJ9740-
FJ9744-

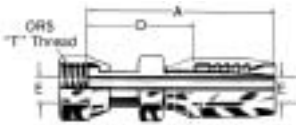

Dash Size	Thread	Hose Size	A		D		EØ	
FJ9740-			mm	in	mm	in	mm	in
0606S	1 ¹ / ₁₆ -16	-06	85,1	3.35	43,7	1.72	6,6	.26
0808S	1 ³ / ₁₆ -16	-08	86,4	3.40	48,0	1.89	9,9	.39
1212S	1 ³ / ₁₆ -12	-12	102,9	4.05	55,4	2.18	15,5	.61
1616S	1 ⁷ / ₁₆ -12	-16	121,4	4.78	67,6	2.66	20,8	.82
FJ9744-			mm	in	mm	in	mm	in
2020S	1 ¹¹ / ₁₆ -12	-20	148,6	5.85	72,4	2.85	26,7	1.05
2424S	2-12	-24	156,0	6.14	81,3	3.20	32,0	1.26

ORS Swivel 45° Elbow

FJ9741-
FJ9745-

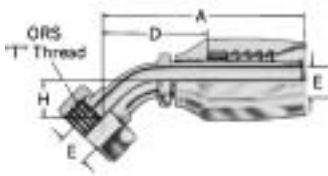

Dash Size	Thread	Hose Size	A		D		EØ		H
FJ9741-			mm	in	mm	in	mm	in	mm
0808S	1 ³ / ₁₆ -16	-08	89,9	3.54	51,3	2.02	9,4	.37	15,0
1212S	1 ³ / ₁₆ -12	-12	115,1	4.53	67,6	2.66	14,2	.56	21,1
1616S	1 ⁷ / ₁₆ -12	-16	140,5	5.53	88,1	3.47	20,6	.81	23,9
FJ9745-			mm	in	mm	in	mm	in	mm
2020S	1 ¹¹ / ₁₆ -12	-20	167,1	6.58	90,9	3.58	25,7	1.01	25,4

ORS Swivel 90° Elbow Short Drop

FJ9742-
FJ9746-

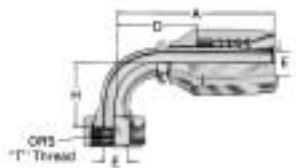

Dash Size	Thread	Hose Size	A		D		EØ		H
FJ9742-			mm	in	mm	in	mm	in	mm
0808S	1 ³ / ₁₆ -16	-08	83,8	3.30	45,5	1.79	9,4	.37	29,2
1212S	1 ³ / ₁₆ -12	-12	112,5	4.43	65,0	2.56	14,2	.56	47,8
1616S	1 ⁷ / ₁₆ -12	-16	133,1	5.24	80,8	3.18	20,6	.81	56,1
FJ9746-			mm	in	mm	in	mm	in	mm
2020S	1 ¹¹ / ₁₆ -12	-20	169,2	6.66	93,0	3.66	25,7	1.01	63,8
2424S	2-12	-24	191,0	7.52	115,8	4.56	30,2	1.19	68,6

ORS Swivel 90° Elbow Long Drop

FJ9743-
FJ9747-

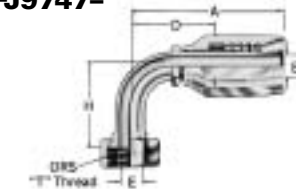

Dash Size	Thread	Hose Size	A		D		EØ		H
FJ9743-			mm	in	mm	in	mm	in	mm
0808S	1 ³ / ₁₆ -16	-08	89,4	3.52	51,3	2.02	9,4	.37	63,8
1212S	1 ³ / ₁₆ -12	-12	112,5	4.43	65,0	2.56	14,2	.56	96,0
1616S	1 ⁷ / ₁₆ -12	-16	135,6	5.34	83,3	3.28	20,6	.81	114,3
FJ9747-			mm	in	mm	in	mm	in	mm
2020S	1 ¹¹ / ₁₆ -12	-20	170,7	6.72	94,5	3.72	25,7	1.01	129,3
2424S	2-12	-24	191,0	7.52	115,8	4.56	32,8	1.29	140,7

Komatsu 30° Swivel-Metric Threads

FJ7286-

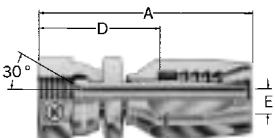

Dash Size	Thread	Hose Size	A		D		EØ	
FJ7286-			mm	in	mm	in	mm	in
0408S	M22 x 1.5	-08	84,3	3.32	42,2	1.66	9,4	.37
0512S	M24 x 1.5	-12	99,6	3.92	52,3	2.06	12,2	.48
0612S	M30 x 1.5	-12	103,6	4.08	56,4	2.22	15,5	.61
1016S	M33 x 1.5	-16	123,4	4.86	70,1	2.76	20,3	.80

NOTE: For correct socket part number, see page 65.

SPECIALTY & TRUCK HOSE

LOW & MEDIUM PRESSURE HOSE

HIGH PRESSURE HOSE

HOSE FITTINGS

ADAPTERS & TUBE FITTINGS

ACCESSORIES & ASSEMBLY INSTRUCTIONS

HOSE ASSEMBLY EQUIPMENT

APPENDICES

Reusable Fittings

Socketless

For use with Hose:

2556, 2565, 2575, FC332, FC647

Socketless, Male Pipe

4738-

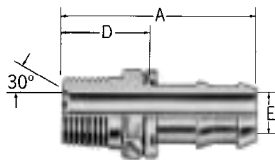

Dash Size	Thread	Hose Size	A		D		EØ	
			mm	in	mm	in	mm	in
4738-			mm	in	mm	in	mm	in
2-4B	1/8-27	-04	35,6	1.40	16,5	.65	4,3	.17
4-4B	1/4-18	-04	40,1	1.58	21,1	.83	4,3	.17
4-6B	1/4-18	-06	44,7	1.76	22,6	.89	7,6	.30
6-6B	3/8-18	-06	44,7	1.76	22,6	.89	7,6	.30
6-8B	3/8-18	-08	48,5	1.91	22,6	.89	9,9	.39
8-8B	1/2-14	-08	54,9	2.16	29,0	1.14	9,9	.39
8-10B	1/2-14	-10	68,1	2.68	29,0	1.14	12,2	.48
12-12B	3/4-14	-12	69,1	2.72	30,7	1.21	15,5	.61

Male Pipe Swivel

FJ9068-

FJ9486-

**Uses Neoprene o-ring

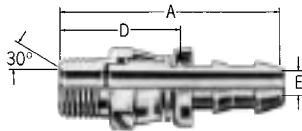

Dash Size	Thread	Hose Size	A		D		EØ	
			mm	in	mm	in	mm	in
FJ9068-			mm	in	mm	in	mm	in
0404S	1/4-18	-04	55,6	2.19	36,3	1.43	4,3	.17
0606S	3/8-18	-06	58,4	2.30	36,3	1.43	7,6	.30
0808S	1/2-14	-08	68,6	2.70	42,9	1.69	9,9	.39
FJ9486-			mm	in	mm	in	mm	in
0204B	1/8-27	-04	43,8	1.70	23,9	.94	3,0	.12

Female Pipe

4753-

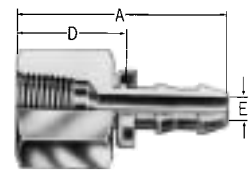

Dash Size	Thread	Hose Size	A		D		EØ	
			mm	in	mm	in	mm	in
4753-			mm	in	mm	in	mm	in
4-4B	1/4-18	-04	38,6	1.52	19,6	.77	4,3	.17
6-6B	3/8-18	-06	43,8	1.70	21,1	.83	7,6	.30
8-8B	1/2-14	-08	51,6	2.03	25,9	1.02	9,9	.39

Female NPSM Swivel

FC5853-

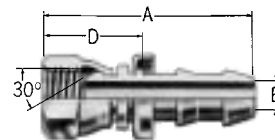

Dash Size	Thread	Hose Size	A		D		EØ	
			mm	in	mm	in	mm	in
FC5853-			mm	in	mm	in	mm	in
0404S	1/4-18	-04	41,7	1.64	22,6	.89	4,3	.17
0606S	3/8-18	-06	44,5	1.75	22,6	.89	7,6	.30
0808S	1/2-14	-08	51,6	2.03	25,7	1.01	9,9	.39
1212S	3/4-14	-12	66,8	2.63	28,2	1.11	15,5	.61

Reusable Fittings

Socketless

For use with Hose:

2556, 2565, 2575, FC332, FC647

Universal†

4797-

SAE 45°*

4739-

SAE 37° (JIC)

4741-

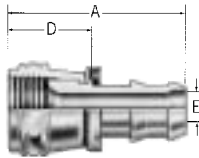

Dash Size	Thread	Hose Size	A		D		EØ	
4797-			mm	in	mm	in	mm	in
4B†	7/16-20	-04	37,1	1.46	18,0	.71	4,3	.17
5-4B†	1/2-20	-04	38,6	1.52	19,6	.77	4,3	.17
8-6B†	3/4-16	-06	45,5	1.79	23,6	.93	7,6	.30
8B†	3/4-16	-08	49,5	1.95	23,6	.93	9,9	.39
10-8B†	7/8-14	-08	52,6	2.07	26,9	1.06	9,9	.39
10B†	7/8-14	-10	66,0	2.60	26,9	1.06	12,2	.48

Dash Size	Thread	Hose Size	A		D		EØ	
4739-			mm	in	mm	in	mm	in
6B*	5/8-18	-06	42,4	1.67	20,6	.81	7,6	.30
12B*	1 1/16-14	-12	68,8	2.71	30,2	1.19	15,5	.61

Dash Size	Thread	Hose Size	A		D		EØ	
4741-			mm	in	mm	in	mm	in
6B	9/16-18	-06	42,4	1.67	20,3	.80	7,6	.30
12B	1 1/16-12	-12	68,8	2.71	30,2	1.19	15,5	.61

SAE 37° (JIC)

Male Flare

190672-

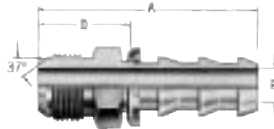

Dash Size	Thread	Hose Size	A		D		EØ	
190672-			mm	in	mm	in	mm	in
4B	7/16-20	-04	41,4	1.63	22,4	.88	4,3	.17
6B	9/16-18	-06	44,5	1.75	22,6	.89	7,6	.30

SAE 45° Male Flare

4742-

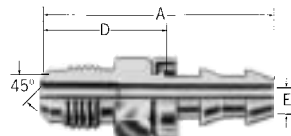

Dash Size	Thread	Hose Size	A		D		EØ	
4742-			mm	in	mm	in	mm	in
4B	7/16-20	-04	40,1	1.58	21,1	.83	4,3	.17
5-4B	1/2-20	-04	41,7	1.64	22,6	.89	4,3	.17
6B	5/8-18	-06	46,2	1.82	24,1	.95	7,1	.28
8B	3/4-16	-08	53,3	2.10	27,4	1.08	9,9	.39

SAE 45° Inverted Male Flare

4740-

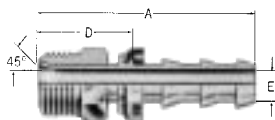

Dash Size	Thread	Hose Size	A		D		EØ	
4740-			mm	in	mm	in	mm	in
3-4B	3/8-24	-04	38,1	1.50	19,1	.75	3,3	.13
4B	7/16-24	-04	38,1	1.50	19,1	.75	4,3	.17
5-4B	1/2-20	-04	40,1	1.58	20,8	.82	4,3	.17
6B	5/8-18	-06	43,7	1.72	21,8	.86	7,6	.30
8B	3/4-18	-08	49,8	1.96	23,9	.94	9,9	.39
10B	7/8-18	-10	64,8	2.55	25,7	1.01	12,2	.48

SAE 42° Inverted Female Flare

4743-

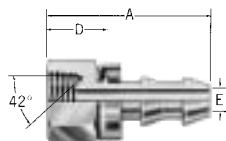

Dash Size	Thread	Hose Size	A		D		EØ	
4743-			mm	in	mm	in	mm	in
3-4B	3/8-24	-04	30,7	1.21	11,7	.46	3,3	.13
4B	7/16-24	-04	30,7	1.21	11,7	.46	4,3	.17
5-4B	1/2-20	-04	31,5	1.24	12,4	.49	4,3	.17
6B	5/8-18	-06	35,8	1.41	14,0	.55	7,6	.30
8-6B	3/4-18	-06	36,6	1.44	14,7	.58	7,6	.30

†Double notch in nut for Universal type identification for both SAE 45° and 37° (JIC) connections.

*Single notch in nut for SAE 45° identification.

SPECIALTY & TRUCK HOSE

LOW & MEDIUM PRESSURE HOSE

HIGH PRESSURE HOSE

HOSE FITTINGS

ADAPTERS & TUBE FITTINGS

ACCESSORIES & ASSEMBLY INSTRUCTIONS

HOSE ASSEMBLY EQUIPMENT

APPENDICES

Reusable Fittings

Socketless

For use with Hose:

2556, 2565, 2575, FC332, FC647

Hose Mender

4772-

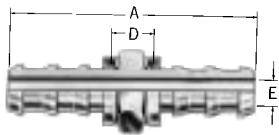

Dash Size	Hose Size	A		D		EØ	
		mm	in	mm	in	mm	in
4772-							
4B	-04	47,0	1.85	8,1	.32	4,3	.17
6B	-06	52,8	2.08	8,1	.32	7,6	.30
8B	-08	62,0	2.44	9,7	.38	9,9	.39
10B	-10	90,2	3.55	11,9	.47	12,2	.48
12B	-12	90,7	3.57	13,7	.54	15,5	.61

Compression Type

4750-

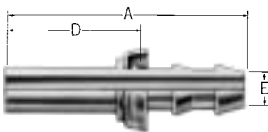

Dash Size	Tube Size	Hose Size	A		D		EØ	
			mm	in	mm	in	mm	in
4750-								
3-4B	-03	-04	45,0	1.77	25,9	1.02	3,3	.13
4B	-04	-04	45,0	1.77	25,9	1.02	4,3	.17
5-4B	-05	-04	46,5	1.83	27,4	1.08	4,3	.17
6B	-06	-06	52,6	2.07	30,7	1.21	7,6	.30
8B	-08	-08	59,4	2.34	33,8	1.33	9,9	.39
10B	-10	-10	65,3	2.57	26,2	1.03	12,2	.48

45° Elbow

SAE 45° Swivel*

FC5848-

SAE 37° (JIC) Swivel

FC5847-

Universal Swivel†

FC5849-

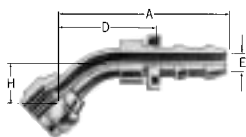

Dash Size	Tube Size	Hose Size	A		D		EØ		H
			mm	in	mm	in	mm	in	
FC5848-									
0606S*	5/8-18	-06	45,7	1.80	23,6	.93	7,6	.30	9,9 .39
FC5847-									
0606S	9/16-18	-06	45,7	1.80	23,6	.93	7,6	.30	9,9 .39
FC5849-									
0404S†	7/16-20	-04	39,6	1.56	20,6	.81	4,3	.17	8,4 .33
0808S†	3/4-16	-08	58,4	2.30	32,5	1.28	9,9	.39	14,0 .55

†Double notch in nut for Universal type identification for both SAE 45° and 37° (JIC) connections.

*Single notch in nut for SAE 45° identification.

Reusable Fittings

Socketless

For use with Hose:

2556, 2565, 2575, FC332, FC647

90° Elbow (Short)

SAE 45° Swivel*

190328-

SAE 37° (JIC) Swivel

190516-

90° Elbow (Long)

SAE 37° (JIC) Swivel

190465-

Universal Swivel†

FC5852-

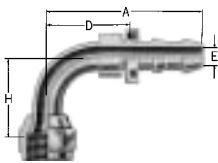

Dash Size	Thread	Hose Size	A		D		EØ		H	
			mm	in	mm	in	mm	in	mm	in
190328-										
6S*	5/8-18	-06	42,9	1.69	21,1	.83	7,6	.30	21,6	.85
190516-										
6S	9/16-18	-06	43,8	1.70	21,1	.83	7,6	.30	21,6	.85
190465-										
6S	9/16-18	-06	43,8	1.70	21,1	.83	7,6	.30	55,4	2.18
FC5852-										
0404S†	7/16-20	-04	36,8	1.45	17,8	.70	4,3	.17	45,7	1.80

SAE Male Inverted Flare 45° Elbow

190944-



Dash Size	Thread	Hose Size	A		D		EØ		H	
			mm	in	mm	in	mm	in	mm	in
190944-										
4S	7/16-24	-04	62,5	2.46	43,8	1.70	4,3	.17	24,4	.96
6S	5/8-18	-06	65,3	2.57	43,8	1.70	7,6	.30	24,4	.96

SAE Male Inverted Flare 90° Elbow (Short)

190327

SAE Male Inverted Flare 90° Elbow (Long)

190326

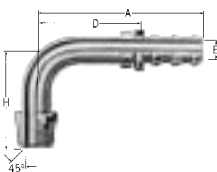

Dash Size	Thread	Hose Size	A		D		EØ		H	
			mm	in	mm	in	mm	in	mm	in
190327-										
4S	7/16-24	-04	52,8	2.08	33,8	1.33	4,3	.17	42,9	1.69
6S	5/8-18	-06	55,9	2.20	33,8	1.33	7,6	.30	43,9	1.73
8S	3/4-18	-08	59,4	2.34	33,8	1.33	9,9	.39	44,5	1.75
190326-										
6S	5/8-18	-06	82,3	3.24	60,5	2.38	7,6	.30	69,3	2.73

ORS Swivel Straight

FJ7044-

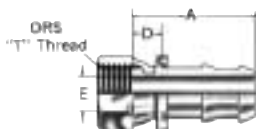

Dash Size	Thread	Hose Size	A		D		EØ	
			mm	in	mm	in	mm	in
FJ7044-								
0404S	9/16-18	-04	27,9	1.10	9,0	.35	4,3	.17
0606S	11/16-16	-06	32,0	1.26	9,9	.39	6,6	.26
0808S	13/16-16	-08	38,1	1.50	12,4	.49	9,7	.38
1212S	13/16-12	-12	52,6	2.07	14,0	.55	15,5	.61

†Double notch in nut for Universal type identification for both SAE 45° and 37° (JIC) connections.

*Single notch in nut for SAE 45° identification.

SPECIALTY & TRUCK HOSE

LOW & MEDIUM PRESSURE HOSE

HIGH PRESSURE HOSE

HOSE FITTINGS

ADAPTERS & TUBE FITTINGS

ACCESSORIES & ASSEMBLY INSTRUCTIONS

HOSE ASSEMBLY EQUIPMENT

APPENDICES

Reusable Fittings

Socketless

For use with Hose:

2556, 2565, 2575, FC332, FC647

ORS Swivel 45° Elbow FJ7023-

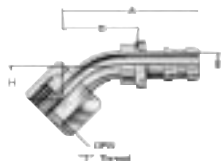

Dash Size	Thread	Hose Size	A		D		EØ		H	
			mm	in	mm	in	mm	in	mm	in
FJ7023-										
0404S	9/16-18	-04	41,7	1.64	22,6	.89	4,3	.17	10,4	.41
0606S	11/16-16	-06	46,7	1.84	24,6	.97	7,6	.30	11,2	.44
0808S	13/16-16	-08	59,4	2.34	33,5	1.32	9,9	.39	15,0	.59
1212S	13/16-12	-12	86,9	3.42	48,3	1.90	15,5	.61	21,1	.83

ORS Swivel 90° Elbow FJ7358-

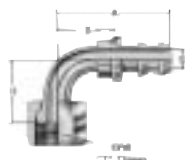

Dash Size	Thread	Hose Size	A		D		EØ		H	
			mm	in	mm	in	mm	in	mm	in
FJ7358-										
0404S	9/16-18	-04	38,6	1.52	19,6	.77	4,3	.17	20,8	.82
0606S	11/16-16	-06	43,8	1.70	23,6	.93	7,6	.30	23,1	.91
0808S	13/16-16	-08	52,3	2.06	26,7	1.05	9,9	.39	29,2	1.15
1212S	13/16-12	-12	84,3	3.32	43,8	1.70	15,5	.61	48,3	1.90

BSP Socketless Male 07.122-

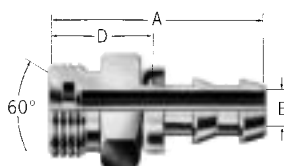

Dash Size	Thread	Hose Size	A		D		EØ	
			mm	in	mm	in	mm	in
07.122-								
4-4	1/4-19	-04	39,5	1.56	20,5	0.81	4.0	.16
6-6	3/8-19	-06	44,0	1.73	22,0	0.87	7.5	.30
8-8	1/2-14	-08	50,0	1.97	24,0	0.94	10.0	.39
10-10	5/8-14	-10	67,0	2.64	28,0	1.10	12.0	.47
12-12	3/4-14	-12	66,5	2.62	28,0	1.10	15.5	.61
16-12	1-11	-12	70,0	2.76	31,5	1.24	15.5	.61

BSP Socketless, Metric Female Swivel 07.390-

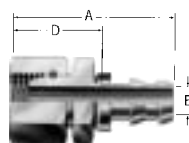

Dash Size	Thread	Hose Size	A		D		EØ	
			mm	in	mm	in	mm	in
07.390-								
4-4	1/4-19	-04	45,0	1.79	26,5	1.04	4.0	.16
6-6	3/8-19	-06	50,0	1.97	28,0	1.10	7.5	.30
8-8	1/2-14	-08	56,0	2.20	30,0	1.18	10.0	.39
10-10	5/8-14	-10	70,0	2.76	31,0	1.22	12.0	.47
12-12	3/4-14	-12	71,5	2.81	33,0	1.30	15.5	.61
16-12	1-11	-12	74,5	2.93	36,0	1.42	15.5	.61

Material for BSP and metric fittings is steel.

Reusable Fittings

Socketless

For use with Hose:

2556, 2565, 2575, FC332, FC647

Metric Male 24° DIN 3901/3902 I. Rh.

07.021-

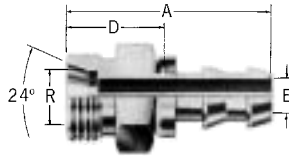

Dash Size	Thread	Hose Size	A		D		EØ		RØ	
			mm	in	mm	in	mm	in	mm	in
07.021-			mm	in	mm	in	mm	in	mm	in
6-4	M12 x 1.5	-04	38,0	1.50	19,0	.75	4,0	.16	6,0	.24
10-6	M16 x 1.5	-06	42,0	1.65	20,0	.79	7,5	.30	10,0	.39
15-8	M22 x 1.5	-08	47,0	1.85	21,0	.83	10,0	.39	15,0	.59

Metric Female Swivel 60° DIN 7631/ 7647

07.114-

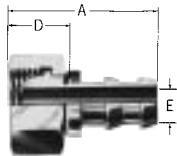

Dash Size	Thread	Hose Size	A		D		EØ	
			mm	in	mm	in	mm	in
07.114-			mm	in	mm	in	mm	in
20-12	M30 x 1.5	-12	56,5	2.22	18	.71	15,5	.61

Metric Universal Female Swivel 24° DIN 3901/3902 I. Rh.

07.006-

07.001-

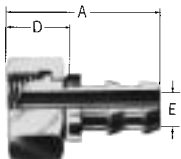

Dash Size	Thread	Hose Size	A		D		EØ		RØ	
			mm	in	mm	in	mm	in	mm	in
07.006-			mm	in	mm	in	mm	in	mm	in
4-4†	M12 x 1.5	-04	37,5	1.48	18,5	.73	4,0	.16	6,0	.24
8-6†	M16 x 1.5	-06	41,5	1.63	19,5	.77	7,5	.30	10,0	.39
07.001-			mm	in	mm	in	mm	in	mm	in
6-4†	M14 x 1.5	-04	35,0	1.38	16,0	.63	4,0	.16	8,0	.31
10-6†	M18 x 1.5	-06	38,5	1.52	16,5	.65	7,5	.30	12,0	.47
13-8†	M22 x 1.5	-08	46,5	1.83	20,5	.81	10,0	.39	15,0	.59
16-10†	M26 x 1.5	-10	57,0	2.24	18,0	.71	12,0	.47	18,0	.71

Material for BSP and metric fittings is steel.

*RØ is tube O.D. and refers to mating component when not called out on the illustration.

†Universal fitting also mates with DIN 7631/7647 60° connections.

SPECIALTY &
TRUCK HOSE

LOW & MEDIUM
PRESSURE HOSE

HIGH PRESSURE HOSE

HOSE FITTINGS

ADAPTERS &
TUBE FITTINGS

ACCESSORIES &
ASSEMBLY INSTRUCTIONS

HOSE ASSEMBLY
EQUIPMENT

APPENDICES

Reusable Fittings

For use with Hose:

2550, 2554, 2570

Power Steering & Airbrake

Male Pipe 479301-

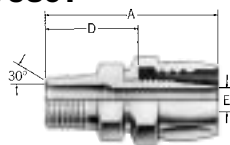

Dash Size	Thread	Hose Size	A		D		EØ	
479301-			mm	in	mm	in	mm	in
4-4S	1/4-18	-04	51,6	2.03	27,7	1.09	4,8	.19
4-6S	1/4-18	-06	54,4	2.14	29,0	1.14	7,6	.30
6-6S	3/8-18	-06	54,4	2.14	29,0	1.14	7,6	.30
8-6S	1/2-14	-06	58,9	2.32	33,5	1.32	7,6	.30
8-8S	1/2-14	-08	72,4	2.85	40,1	1.58	9,1	.36

SAE 37° (JIC) Swivel 190800-

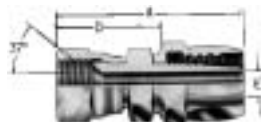

Dash Size	Thread	Hose Size	A		D		EØ	
190800-			mm	in	mm	in	mm	in
4S	7/16-20	-04	52,8	2.08	29,0	1.14	4,3	.17
5-4S	1/2-20	-04	54,1	2.13	30,2	1.19	4,8	.19
6S	9/16-18	-06	58,6	2.31	33,3	1.31	7,6	.30

SAE 37° (JIC) Male Flare FC7275-

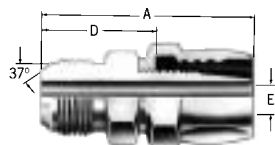

Dash Size	Thread	Hose Size	A		D		EØ	
FC7275-			mm	in	mm	in	mm	in
0606S	9/16-18	-06	58,9	2.32	33,5	1.32	7,6	.30

USF Swivel 479501-

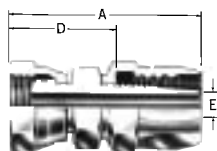

Dash Size	Thread	Hose Size	A		D		EØ	
479501-			mm	in	mm	in	mm	in
8-6S	3/4-20	-06	58,2	2.29	33,0	1.30	7,6	.30

Male Inverted Flare 190604-

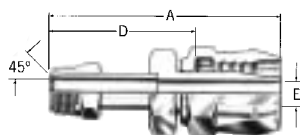

Dash Size	Thread	Hose Size	A		D		EØ	
190604-			mm	in	mm	in	mm	in
4-6S	7/16-24	-06	67,8	2.67	42,4	1.67	4,6	.18
6S	5/8-18	-06	67,8	2.67	42,4	1.67	7,6	.30

Male Inverted Flare 45° Elbow 190605-

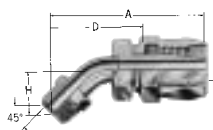

Dash Size	Thread	Hose Size	A		D		EØ		H
190605-			mm	in	mm	in	mm	in	mm
4-6S	7/16-24	-06	74,9	2.95	49,5	1.95	4,6	.18	24,4
6S	5/8-18	-06	74,9	2.95	49,5	1.95	7,6	.30	24,4

NOTE: For correct socket part number, see page 65.

Reusable Fittings

Power Steering & Airbrake

For use with Hose:

2550, 2554, 2570

Male Inverted Flare 90° Elbow 190606-

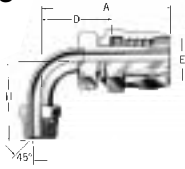

Dash Size	Thread	Hose Size	A		D		EØ		H	
190606-			mm	in	mm	in	mm	in	mm	in
4-6S	7/16-24	-06	65,5	2.58	40,1	1.58	4,6	.18	42,9	1.69
5-6S	1/2-20	-06	65,5	2.58	40,1	1.58	6,1	.24	42,9	1.69
6S	5/8-18	-06	65,5	2.58	40,1	1.58	7,6	.30	43,9	1.73

SAE 45° Swivel 479601-

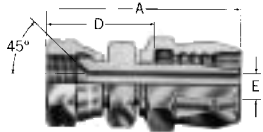

Dash Size	Thread	Hose Size	A		D		EØ	
479601-			mm	in	mm	in	mm	in
4-6S	7/16-20	-06	53,8	2.12	28,7	1.13	4,3	.17
6S	5/8-18	-06	58,6	2.31	33,3	1.31	7,6	.30

SAE 45° Swivel 45° Elbow 190607-

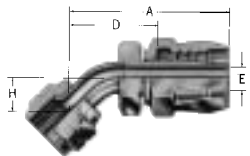

Dash Size	Thread	Hose Size	A		D		EØ		H	
190607-			mm	in	mm	in	mm	in	mm	in
4-6S	7/16-20	-06	52,3	2.06	26,9	1.06	4,6	.18	8,4	.33
6S	5/8-18	-06	55,4	2.18	30,0	1.18	7,6	.30	9,9	.39

SAE 45° Swivel 90° Elbow 190608-

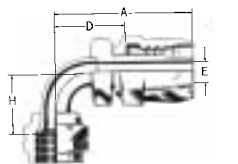

Dash Size	Thread	Hose Size	A		D		EØ		H	
190608-			mm	in	mm	in	mm	in	mm	in
4-6S	7/16-20	-06	49,5	1.95	24,1	.95	4,6	.18	17,3	.68
6S	5/8-18	-06	52,8	2.08	27,4	1.08	7,6	.30	21,6	.85

SAE Male Flareless with Nut and Ferrule 190609-

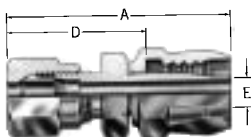

Dash Size	Thread	Hose Size	A		D		EØ	
190609-			mm	in	mm	in	mm	in
4-6S	7/16-20	-06	62,0	2.44	24,6	.97	5,1	.20
6S	9/16-18	-06	63,5	2.50	24,9	.98	7,1	.28

NOTE: For correct socket part number, see page 65.

SPECIALTY &
TRUCK HOSE

LOW & MEDIUM
PRESSURE HOSE

HIGH PRESSURE HOSE

HOSE FITTINGS

ADAPTERS &
TUBE FITTINGS

ACCESSORIES &
ASSEMBLY INSTRUCTIONS

HOSE ASSEMBLY
EQUIPMENT

APPENDICES

Reusable Fittings Accessories

For use with Hose:
2550, 2554, 2570



Union
3/4-20 USF to 1/4-inch
male pipe thread
2038-4-8S

3/4-20 USF to 3/8-inch
male pipe thread
2038-6-8S



Gladhand
1/2-inch female
pipe thread
190231-8

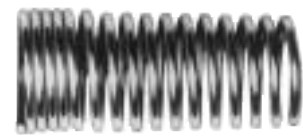

Spring Guard
Fittings specified in
charts can be used
with or without
spring guard
900774-6

Band Clamp

For use with Hose:
FC252, FC352



**Band Clamp,
Silicone Hose Clamp**

FF9148-

Dash Size	Use with FC252 Hose Dash Size	Use with FC352 Hose Dash Size
FF9148-		
12	-08, -10	-08, -10
16	-12	-12, -14
24	-16	-16, -18, -20, -22
32		-24, -26, -28
40		-32, -36, -38
48		-40, -44
52		-48
60		-56
68		-64

Band Clamp and Nipples

For use with Hose:
2661, FC619



**Band Clamp and
Nipples, Bank Clamp**

FF90152-

Dash Size	Hose Size
FF90152-	
01	-12
01	-16
01	-20

Reusable Fittings

Railroad Airbrake

For use with Hose:

1531, 1531A

Straight Split Flange

FJ4649-

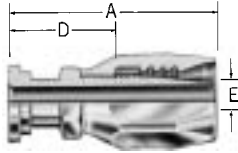

Nipple Part #	Socket Part #	Hose Size	A		D		EØ	
			mm	in	mm	in	mm	in
FJ4649-1216S	1219-16S	-16	78,2	3.08	43,4	1.71	20,6	.81
FJ4649-1620S	1219-20S	-20	87,9	3.46	50,0	1.97	26,7	1.05
FJ4649-2024S	1219-24S	-24	84,8	3.34	43,9	1.73	32,5	1.28

45° Elbow 2 Bolt Split Flange

FJ4709-

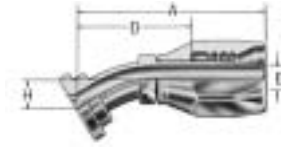

Nipple Part #	Socket Part #	Hose Size	A		D		EØ		H	
			mm	in	mm	in	mm	in	mm	in
FJ4709-1620S	1219-20S	-20	102,4	4.03	64,5	2.54	26,7	1.05	23,1	.91
FJ4709-2024S	1219-24S	-24	120,1	4.73	79,2	3.12	32,5	1.28	26,2	1.03

90° Elbow 2 Bolt Split Flange

FJ4650-

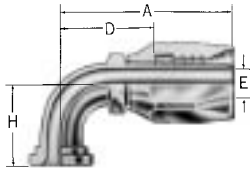

Nipple Part #	Socket Part #	Hose Size	A		D		EØ		H	
			mm	in	mm	in	mm	in	mm	in
FJ4650-1216S	1219-16S	-16	92,7	3.65	57,9	2.28	20,6	.81	52,3	2.06
FJ4650-1620S	1219-20S	-20	105,4	4.15	67,6	2.66	26,7	1.05	58,6	2.31
FJ4650-2024S	1219-24S	-24	116,8	4.60	116,8	4.60	32,5	1.28	66,8	2.63

*Contact Eaton for flange part number

Male Pipe

458-

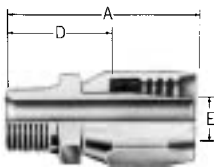

Dash Size	Thread	Hose Size	A		D		EØ	
			mm	in	mm	in	mm	in
8-10S	1/2-14	-10	72,4	2.85	42,4	1.67	11,4	.45
12-12S	3/4-14	-12	74,2	2.92	42,4	1.67	14,7	.58
12-16S	3/4-14	-16	80,2	3.16	45,5	1.79	20,6	.81
16-16S	1-11 1/2	-16	85,1	3.35	50,8	1.98	20,6	.81
16-20S	1-11 1/2	-20	91,7	3.61	53,6	2.11	26,7	1.05
16-24S	1-11 1/2	-24	94,7	3.73	53,8	2.12	32,5	1.28
20-24S	1 1/4-11 1/2	-24	95,5	3.76	54,6	2.15	32,5	1.28

SPECIALTY & TRUCK HOSE

LOW & MEDIUM PRESSURE HOSE

HIGH PRESSURE HOSE

HOSE FITTINGS

ADAPTERS & TUBE FITTINGS

ACCESSORIES & ASSEMBLY INSTRUCTIONS

HOSE ASSEMBLY EQUIPMENT

APPENDICES

Reusable Fittings

"Super Gem"

For use with PTFE Hose:

2807, FC465, FC807

Male Pipe 38-190627-

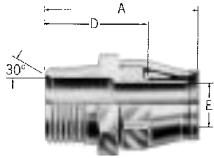

Dash Size	Thread	Hose Size	A		D		EØ	
			mm	in	mm	in	mm	in
38-190627-								
2-4*	1/8-27	-04	34,3	1.35	22,6	.89	4,1	.16
4-4*	1/4-18	-04	39,1	1.54	27,4	1.08	4,1	.16
4-5*	1/4-18	-05	40,1	1.58	27,2	1.07	5,8	.23
4-6*	1/4-18	-06	42,2	1.66	28,7	1.13	7,1	.28
6-6*	3/8-18	-06	42,2	1.66	28,7	1.13	7,1	.28
6-8*	3/8-18	-08	45,5	1.79	29,5	1.16	9,7	.38
8-10*	1 1/2-14	-10	54,1	2.13	37,1	1.46	11,9	.47
12-12*	3/4-14	-12	57,4	2.26	40,9	1.61	15,0	.59
16-16*	1-11 1/2	-16	63,0	2.48	47,2	1.86	21,1	.83
20-20*	1 1/4-11 1/2	-20	71,9	2.83	55,1	2.17	26,9	1.06

SAE 37° (JIC) Swivel 63-190600-

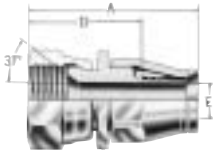

Dash Size	Thread	Hose Size	A		D		EØ	
			mm	in	mm	in	mm	in
63-190600-								
3*	3/8-24	-03	35,0	1.38	26,4	1.04	2,2	.09
4*	7/16-20	-04	40,1	1.58	28,7	1.13	4,1	.16
5*	1/2-20	-05	42,7	1.68	29,7	1.17	5,8	.23
6*	9/16-18	-06	44,2	1.74	31,0	1.22	6,6	.26
8*	3/4-16	-08	50,8	1.98	34,3	1.35	9,7	.38
10*	7/8-14	-10	56,4	2.22	39,1	1.54	11,9	.47
12*	1 1/16-12	-12	59,2	2.33	42,4	1.67	15,0	.59
16*	1 5/16-12	-16	64,0	2.52	48,5	1.91	21,1	.83
20*	1 5/8-12	-20	74,2	2.92	57,7	2.27	26,9	1.06

*Also supplied in stainless steel. Add suffix "C" to part number and delete prefix "63" or "38".

NOTE: Sleeve part number 900568-(size).

Note: For correct socket part number, see page 65.

Reusable Fittings

“Super Gem”

For use with PTFE Hose:

2807, FC465, FC807

SAE 45° Swivel 63-190990-

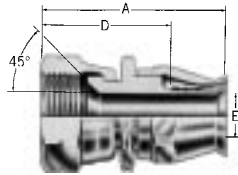

Dash Size	Thread	Hose Size	A		D		EØ	
			mm	in	mm	in	mm	in
63-190990-								
4	7/16-20	-04	40,1	1.58	28,4	1.12	4,1	.16
5	1/2-20	-05	42,7	1.68	29,7	1.17	5,8	.23
6	5/8-18	-06	45,0	1.77	31,8	1.25	7,1	.28
8	3/4-16	-08	50,8	1.98	34,5	1.36	9,7	.38
10	7/8-14	-10	56,4	2.22	39,1	1.54	11,9	.47
12	1 1/16-14	-12	59,2	2.33	42,4	1.67	15,0	.59

45° Elbow

Universal 190773-

SAE 45° Swivel FC9341-

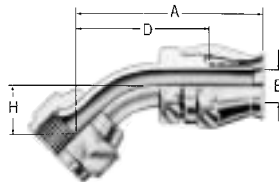

Dash Size	Thread	Hose Size	A		D		EØ		H	
			mm	in	mm	in	mm	in	mm	in
190773-										
3S	3/8-24	-03	38,1	1.50	29,7	1.17	2,3	.09	11,7	.46
4S	7/16-20	-04	38,4	1.51	26,7	1.05	4,1	.16	8,4	.33
5S	1/2-20	-05	41,1	1.62	28,2	1.11	5,8	.23	9,1	.36
6S†	9/16-18	-06	43,7	1.72	30,5	1.20	7,1	.28	9,9	.39
8S	3/4-16	-08	57,7	2.27	41,7	1.64	9,7	.38	14,0	.55
10S	7/8-14	-10	62,5	2.46	45,5	1.79	11,9	.47	16,3	.64
12S†	1 1/16-12	-12	72,6	2.86	56,1	2.21	15,0	.59	19,8	.78
16S†	1 5/16-12	-16	83,8	3.30	68,1	2.68	21,1	.83	27,2	1.07
20S	1 5/8-12	-20	96,5	3.80	79,8	3.14	26,9	1.06	31,0	1.22
FC9341-			mm in		mm in		mm in		mm in	
0606S	5/8-18	-06	43,7	1.72	30,5	1.20	7,1	.28	9,9	.39
1212S	1 1/16-14	-12	72,6	2.86	56,1	2.21	15,0	.59	19,8	.78

Universal 190772-

SAE 45° Swivel FC9171-

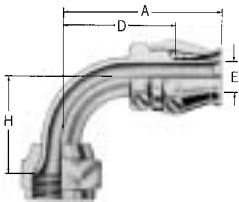

Dash Size	Thread	Hose Size	A		D		EØ		H	
			mm	in	mm	in	mm	in	mm	in
190772-										
3S	3/8-24	-03	32,3	1.27	23,6	.93	2,3	.09	22,1	.87
4S	7/16-20	-04	35,8	1.41	24,1	.95	4,1	.16	17,3	.68
5S	1/2-20	-05	38,6	1.52	25,4	1.00	5,8	.23	19,6	.77
6S†	9/16-18	-06	41,1	1.62	27,9	1.10	7,1	.28	21,6	.85
8S	3/4-16	-08	51,6	2.03	35,8	1.41	9,7	.38	27,7	1.09
10S	7/8-14	-10	54,9	2.16	37,8	1.49	11,9	.47	31,2	1.23
10-12S	7/8-14	-12	56,6	2.23	39,9	1.57	11,7	.46	31,2	1.23
12S†	1 1/16-12	-12	71,6	2.82	55,1	2.17	15,0	.59	46,2	1.82
12-16S†	1 1/16-14	-16	72,9	2.87	56,4	2.22	14,7	.58	46,2	1.82
16S†	1 5/16-12	-16	78,7	3.10	63,2	2.49	20,8	.82	60,7	2.39
FC9171-			mm in		mm in		mm in		mm in	
0606S	5/8-18	-06	41,1	1.62	27,9	1.10	7,1	.28	21,6	.85
1212S	1 1/16-14	-12	71,1	2.80	55,6	2.19	15,0	.59	46,2	1.82

†SAE 37° (JIC) swivel only

Universal type identification for both SAE 45° and 37° connections.

NOTE: Sleeve part number 900568-(size).

Note: For correct socket part number, see page 65.

SPECIALTY &
TRUCK HOSE

LOW & MEDIUM
PRESSURE HOSE

HIGH PRESSURE HOSE

HOSE FITTINGS

ADAPTERS &
TUBE FITTINGS

ACCESSORIES &
ASSEMBLY INSTRUCTIONS

HOSE ASSEMBLY
EQUIPMENT

APPENDICES

Reusable Fittings

"Super Gem"

For use with PTFE Hose:

2807, FC465, FC807

2-Bolt Swivel Flange 63-190626-

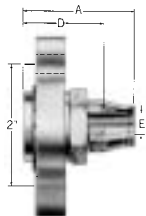

Dash Size	Flange Head Dia.		Hose Size	A		D		EØ	
	mm	in		mm	in	mm	in	mm	in
63-190626-									
6	73,2	2.88	-06	45,2	1.78	32,0	1.26	7,1	.28
12	73,2	2.88	-12	52,6	2.07	36,1	1.42	14,2	.56
16	73,2	2.88	-16	55,4	2.18	37,8	1.49	4,8	.19

Compression Ball Sleeve 38-191074-

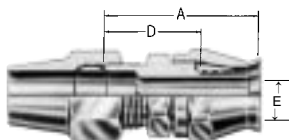

Dash Size	Tube Size	Hose Size	A		D		EØ	
			mm	in	mm	in	mm	in
38-191074								
8	-08	-08	42,2	1.66	26,4	1.04	9,7	.38
10	-10	-10	47,0	1.85	30,0	1.18	11,9	.47
12	-12	-12	52,8	2.08	35,8	1.41	15,0	.59

SAE Ball Sleeve* 190718-

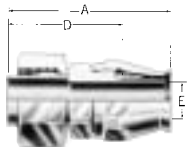

Dash Size	Thread Size	Hose Size	A		D		EØ	
			mm	in	mm	in	mm	in
190718-								
8S	1 ¹ / ₁₆ -20	-08	52,6	2.07	36,6	1.44	9,7	.38
10-8S	1 ³ / ₁₆ -18	-08	52,6	2.07	36,6	1.44	9,7	.38
10S	1 ³ / ₁₆ -18	-10	54,9	2.16	37,8	1.49	12,2	.48
12S	1-18	-12	61,5	2.42	44,7	1.76	15,0	.59

Special Ball Sleeve* 190742-

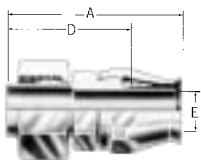

Dash Size	Thread Size	Hose Size	A		D		EØ	
			mm	in	mm	in	mm	in
190742-								
10S	7/ ₈ -18	-10	54,9	2.16	37,8	1.49	12,2	.48

SAE Male Inverted Flare Straight FC9062-

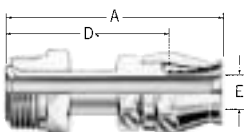

Dash Size	Thread Size	Hose Size	A		D		EØ	
			mm	in	mm	in	mm	in
FC9062-								
0404S	7/ ₁₆ -24	-04	54,1	2.13	42,2	1.66	4,1	.16
0505S	1/ ₂ -20	-05	55,1	2.17	42,2	1.66	5,8	.23
0506S	1/ ₂ -20	-06	56,1	2.21	42,9	1.69	5,3	.21
0606S	5/ ₈ -18	-06	56,1	2.21	42,9	1.69	7,1	.28
0808S	3/ ₄ -18	-08	62,7	2.47	46,7	1.84	9,7	.38
1010S	7/ ₈ -18	-10	70,6	2.78	53,6	2.11	11,9	.47
1212S	1 ¹ / ₁₆ -16	-12	76,7	3.02	60,2	2.37	15,0	.59

NOTE: For correct socket part number, see page 65

*Some B-W compressor adapters require special mating nuts. For 1³/₁₆"-18 thread size for 1/2" O.D. tubing, use fitting 190718-10-8S with 2807-8 Hose.

For special thread size 7/₈"-18, use fitting 190742-10S with 2807-10 Hose.

NOTE: Sleeve part number is 900568-(size)

Reusable Fittings

“Super Gem”

For use with PTFE Hose:

2807, FC465, FC807

SAE Male Inverted Flare 45° Elbow FC9063-

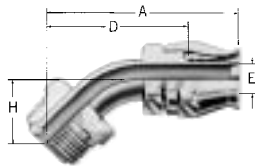

Dash Size	Thread	Hose Size	A		D		EØ		H	
			mm	in	mm	in	mm	in	mm	in
FC9063-										
0505S	1/2-20	-05	62,5	2.46	49,3	1.94	5,8	.23	24,4	.96
0506S	1/2-20	-06	63,5	2.50	50,0	1.97	5,3	.21	24,4	.96
0606S	5/8-18	-06	63,5	2.50	50,0	1.97	7,1	.28	24,4	.96
0808S	3/4-18	-08	67,6	2.66	51,8	2.04	9,7	.38	23,6	.93
1010S	7/8-18	-10	75,2	2.96	58,2	2.29	11,9	.47	26,2	1.03
1212S	1 1/16-16	-12	78,7	3.10	62,0	2.44	15,0	.59	27,9	1.10

SAE Male Inverted Flare 90° Elbow 190950-

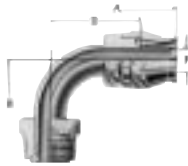

Dash Size	Thread	Hose Size	A		D		EØ		H	
			mm	in	mm	in	mm	in	mm	in
190950-										
4S	7/16-24	-04	51,8	2.04	39,9	1.57	4,1	.16	42,9	1.69
5S	1/2-20	-05	52,8	2.08	39,9	1.57	5,8	.23	42,9	1.69
5-6S	1/2-20	-06	53,8	2.12	40,6	1.60	5,3	.21	42,9	1.69
6S	5/8-18	-06	53,8	2.12	40,6	1.60	7,1	.28	43,9	1.73
8S	3/4-18	-08	58,9	2.32	42,9	1.69	9,7	.38	44,2	1.74
10S	7/8-18	-10	67,6	2.66	50,5	1.99	11,9	.47	56,1	2.21
12S	1 1/16-16	-12	69,3	2.73	52,6	2.07	15,0	.59	59,7	2.35

Note: Sleeve part number is 9005168-(size).

For use with PTFE Hose:

2808

Male Pipe 38-190628-

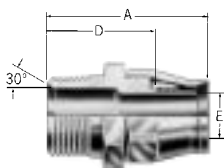

Dash Size	Thread	Hose Size	A		D		EØ	
			mm	in	mm	in	mm	in
38-190628-								
6-8	3/8-18	-08	48,5	1.91	33,5	1.32	8,9	.35
8-10	1/2-14	-10	53,8	2.12	39,4	1.55	11,2	.44
12-12	3/4-14	-12	60,9	2.40	41,4	1.63	14,2	.56
16-16	1-11 1/2	-16	66,8	2.63	47,2	1.86	21,1	.83
20-20	1 1/4-11 1/2	-20	77,5	3.05	53,1	2.09	26,9	1.06
24-24	1 1/2-11 1/2	-24	80,2	3.16	55,9	2.20	32,5	1.28

SAE 37° (JIC) Swivel 63-190535-

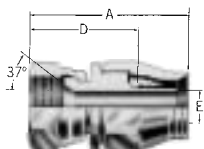

Dash Size	Thread	Hose Size	A		D		EØ	
			mm	in	mm	in	mm	in
63-190535-								
8	3/4-16	-08	52,6	2.07	37,6	1.48	8,9	.35
10	7/8-14	-10	56,4	2.22	41,7	1.64	11,2	.44
12	1 1/16-12	-12	62,5	2.46	43,8	1.70	14,2	.56
16	1 5/16-12	-16	67,6	2.66	48,3	1.90	21,1	.83
20	1 5/8-12	-20	79,8	3.14	55,6	2.19	26,9	1.06
24	1 7/8-12	-24	85,9	3.38	61,5	2.42	32,5	1.28

Note: Sleeve part number is 900515-(size)

SPECIALTY & TRUCK HOSE

LOW & MEDIUM PRESSURE HOSE

HIGH PRESSURE HOSE

HOSE FITTINGS

ADAPTERS & TUBE FITTINGS

ACCESSORIES & ASSEMBLY INSTRUCTIONS

HOSE ASSEMBLY EQUIPMENT

APPENDICES

Split Flanges Kits & O-Rings

SPECIALTY & TRUCK HOSE

LOW & MEDIUM PRESSURE HOSE

HIGH PRESSURE HOSE

HOSE FITTINGS

ADAPTERS & TUBE FITTINGS

ACCESSORIES & ASSEMBLY INSTRUCTIONS

HOSE ASSEMBLY EQUIPMENT

APPENDICES



Split flanges

Eaton has standard pressure series (code 61) and high pressure series (code 62) split flange components in kit form that save time in selecting and ordering. Each kit includes two flange

halves, four grade-8 hex bolts, four lock washers and an o-ring. The standard kit has a Buna-N 90 durometer o-ring that is compatible with petroleum and water-base hydraulic fluids. Optional kits contain EPR

and Viton* o-rings for applications where fluid compatibility or high temperatures require other than Buna-N o-rings.

**Viton is a trademark of E.I. DuPont.*

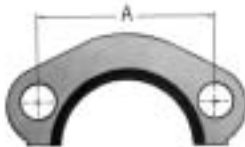

Two methods can be used to determine the flange dash size and code. The first is by measuring the flange head diameter on the fitting itself. This is referred to as the "K" dimension. The second is by measuring the "A" dimension on the flange or

the flange port. Either will determine the dash size and the code since these dimensions are exclusive to either code 61 or code 62 split flange kits. See chart below for these dimensions.

In some cases, split flange fittings are available for hoses which exceed the pressures listed; when ordering fittings or hose assemblies, the terminal end performance rating may reduce the overall rating of the assembly.

"A" Dim.	"K" Flange Head Dia.	Flange Dash Size	Maximum Operating Pressure*		Recommended Bolt Torque (lb-in)
			bar	psi	
Code 61					
1.50	1.19	-08	350,0	5000	175-225
1.88	1.50	-12	350,0	5000	225-350
2.06	1.75	-16	350,0	5000	325-425
2.31	2.00	-20	280,0	4000	425-550
2.75	2.38	-24	210,0	3000	550-700
3.06	2.81	-32	210,0	3000	650-800
3.50	3.31	-40	175,0	2500	950-1100
4.19	4.00	-48	140,0	2000	1650-1800
Code 62					
1.59	1.25	-08	420,0	6000	175-225
2.00	1.63	-12	420,0	6000	300-400
2.25	1.88	-16	420,0	6000	500-600
2.62	2.12	-20	420,0	6000	750-900
3.12	2.50	-24	420,0	6000	1400-1600
3.81	3.12	-32	420,0	6000	2400-2600

**Per SAE J518 standard.*

Assembly Procedure

Many leakage problems can be avoided if the split flanges are properly assembled.

To Properly Assemble:

1. Clean all mating surfaces.
2. Lubricate the o-ring.
3. Partially tighten each bolt in rotation until all are fully tightened to the recommended torque value.

How to Order:

1. Determine the dash size and the code.
2. Select o-ring for fluid compatibility.
3. Order by kit number shown on pages 190-194.

Split Flanges, Kits, O-Rings

Split Flange Kits – SAE Standard Pressure Series (Code 61) SAE J518

O-Ring Material:
Buna-N 90 Durometer

Temperature Range:
-40°F to +250°F
(-40°C to + 121°C)

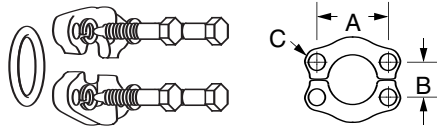

Nominal Flange Size	Complete Kit	*Flange Halves 2 Req'd	*Buna-N O-ring 1 Req'd	*Bolts 4 Req'd	*Lock Washer 4 Req'd	A	B	C	Bolt Torque lb.-in
1/2	FF593-08	449-74446-8	FF9446-210	FF9442-0520-94	210104-5S	1.50	.68	.34	175-225
3/4	FF593-12	449-74446-12	FF9446-214	FF9442-0620-94	210104-6S	1.88	.88	.41	250-350
1	FF593-16	449-74446-16	FF9446-219	FF9442-0620-94	210104-6S	2.06	1.04	.41	325-425
1-1/4	FF593-20	449-74446-20	FF9446-222	FF9442-0724-94	210104-7S	2.31	1.18	.48	425-550
1-1/2	FF593-24	449-74446-24	FF9446-225	FF9442-0824-94	210104-8S	2.75	1.40	.53	550-700
2	FF593-32	449-74446-32	FF9446-228	FF9442-0824-94	210104-8S	3.06	1.68	.53	650-800
2-1/2	FF593-40	449-74446-40	FF9446-232	FF9442-0828-94	210104-8S	3.50	2.00	.53	950-1100
3	FF593-48	449-74446-48	FF9446-237	FF9442-1028-94	210104-10S	4.19	2.44	.66	1650-1800

* Included in Kit.

**Viton kit available as part # FF687-Size. EPR kit available as part # FF688-size. See pg. 192 for Viton and EPR o-ring part numbers.
Note: All measurements in inches.

Split Flange Kits – SAE High Pressure Series (Code 62) SAE J518

O-Ring Material:
Buna-N 90 Durometer

Temperature Range:
-40°F to +250°F
(-40°C to + 121°C)

Note: Code 62 split flange kits cannot be used with Cat flange fittings. Use existing split flanges.

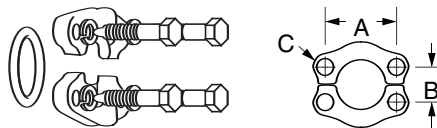

Nominal Flange Size	Complete Kit	*Flange Halves 2 Req'd	*Buna-N O-ring 1 Req'd	*Bolts 4 Req'd	*Lock Washer 4 Req'd	A	B	C	Bolt Torque lb.-in
3/4	FF595-12	FC3425-12-449	FF9446-214	FF9442-0624-94	210104-6S	2.00	.94	.42	300-400
1	FF595-16	FC3425-16-449	FF9446-219	FF9442-0728-94	210104-7S	2.25	1.10	.50	500-600
1-1/4	FF595-20	FC3425-20-449	FF9446-222	FF9442-0828-94	210104-8S	2.62	1.24	.60	750-900
1-1/2	FF595-24	FC3425-24-449	FF9446-225	FF9442-1036-94	210104-10S	3.12	1.44	.66	1400-1600
2	FF595-32	FC3425-32-449	FF9446-228	FF9442-1244-94	210104-12S	3.81	1.76	.78	2400-2600

* Included in Kit.

Viton Kit available as part #FF689-size. See page 192 for Viton o-ring part numbers.
Note: All measurements in inches.

SPECIALTY & TRUCK HOSE

LOW & MEDIUM PRESSURE HOSE

HIGH PRESSURE HOSE

HOSE FITTINGS

ADAPTERS & TUBE FITTINGS

ACCESSORIES & ASSEMBLY INSTRUCTIONS

HOSE ASSEMBLY EQUIPMENT

APPENDICIES

Split Flanges, Kits, O-Rings

Split Flange Kits

Split Flange Kits – SAE Standard Pressure Series (Code 61) Performance

O-Ring Material:
Buna-N 90 Durometer

Temperature Range:
-40°F to +250°F
(-40°C to + 121°C)

Flange Material:
Powdered Metal. Equivalent to SAE J518 Code 61 Performance.

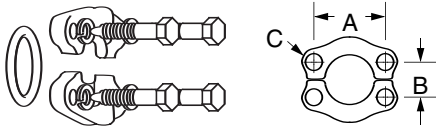

Nominal Flange Size	Complete Kit	*Flange Halves 2 Req'd	*Buna-N O-ring 1 Req'd	*Bolts 4 Req'd	*Lock Washer 4 Req'd	A	B	C	Bolt Torque lb.-in
1	FF824-16	FC2713-16-170	FF9446-219	FF9442-0620-94	210104-2-6S	2.06	1.04	.41	325-425
1-1/4	FF824-20	FC2713-20-170	FF9446-222	FF9442-0724-94	210104-7S	2.31	1.18	.47	425-550
1-1/2	FF824-24	FC2713-24-170	FF9446-225	FF9442-0824-94	210104-8S	2.75	1.40	.53	550-700

* Included in Kit.

Note: All measurements in inches.

4 Hole Flange - SAE Standard Pressure Series (Code 61) SAE J518

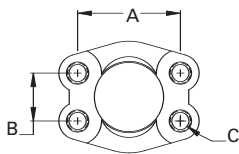

Nominal Flange Size	4 Bolt Flange*	A	B	C (Threaded)
3/4	FC2119-12-449	1.88	.88	3/8-16
1	FC2119-12-449	2.06	1.03	7/16-14
1-1/4	FC2119-12-449	2.31	1.19	3/8-16
1-1/2	FC2119-12-449	2.75	1.41	1/2-13
2	FC2119-12-449	3.06	1.69	1/2-13
2-1/2	FC2119-12-449	3.50	2.00	1/2-13

*Available without threaded hoses as part #FC3459-size-449.

Note: All measurements in inches.

O-Rings for SAE J518 Split Flange



O-Ring Base No.	Material	Operating Temperature Range
FF9016 EPDM	80 durometer	-65°F to +300°F (-55°C to +150°C)
FF9446 Buna-N	90 durometer Buna-N	-40°F to +250°F (-40°C to +121°C)
22046 Viton	90 durometer	-15°F to +400°F (-25°C to +205°C)

O-Ring Dash Size Designation	Flange Dash Size	Nominal Flange Size	A		E	
			mm	in	mm	in
210	08	1/2	18,5	.734	3.5	.139
214	12	3/4	24,9	.984	3.5	.139
219	16	1	32,9	1.296	3.5	.139
222	20	1 1/4	37,7	1.484	3.5	.139
225	24	1 1/2	47,2	1.859	3.5	.139
228	32	2	56,7	2.234	3.5	.139
232	40	2 1/2	69,4	2.734	3.5	.139
237	48	3	85,3	3.359	3.5	.139

O-Rings

Cat Flange D-Ring*

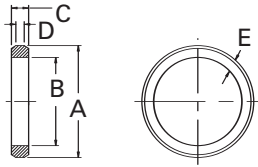

Part Number	A Ref		B Ref		C Ref		D Ref		E Ref	
	mm	in	mm	in	mm	in	mm	in	mm	in
FF90319-12	32,3	1.27	25,4	1.00	5,1	.20	2,5	.10	3,6	.14
FF90319-16	38,6	1.52	31,8	1.25	5,1	.20	2,5	.10	3,6	.14
FF90319-20	45,0	1.77	38,1	1.50	5,1	.20	2,5	.10	3,6	.14
FF90319-24	51,6	2.03	44,7	1.76	5,1	.20	2,5	.10	3,6	.14
FF90319-32	70,6	2.78	64,0	2.52	5,1	.20	2,5	.10	3,6	.14

Temperature range: -40°F to +212°F.

Material: Nitrile (Buna-N)

*To be used only with Cat flange.

O-Rings for Staplok® Fittings



O-Ring Base No.	Material	Operating Temperature Range
FF9508 (Standard)	90 durometer Buna-N	-40°F to +250°F (-40°C to +121°C)

O-Ring Dash Size Designation	Staplok Dash Size	A		E	
		mm	in	mm	in
04	04	6,1	.24	2,0	.08
06	06	9,9	.39	2,0	.08
08	08	13,0	.51	2,5	.10
12	12	19,1	.75	2,5	.10
16	16	24,9	.98	2,5	.10
20	20	33,0	1.30	2,5	.10
24	24	40,2	1.58	3,0	.12
32	32	50,0	1.97	3,0	.12

Backup Rings and Staples for Staplok Fittings



FF9509



FF9672

Hose Size	Backup Ring Part No.	Staple Part No.	Staplok Fittings
-04	FF9509-04	FF9672-04S	04
-06	FF9509-06	FF9672-06S	06
-08	FF9509-08	FF9672-08S	08
-12	FF9509-12	FF9672-12S	12
-16	FF9509-16	FF9672-16S	16
-20	FF9509-20	FF9672-20S	20
-32	FF9509-32	FF9672-32S	32

O-Rings for Bump Tube O-Ring Seal and O-Ring Pilot Fittings



O-Ring Part Number	O-Ring Pilot Dash Size	A		E	
		mm	in	mm	in
22546-11	-06	7,6	.30	1,8	.07
22546-13	-08	10,9	.43	1,8	.07
22546-15	-10	14,0	.55	1,8	.07
22546-17	-12	17,3	.68	1,8	.07

SPECIALTY & TRUCK HOSE

LOW & MEDIUM PRESSURE HOSE

HIGH PRESSURE HOSE

HOSE FITTINGS

ADAPTERS & TUBE FITTINGS

ACCESSORIES & ASSEMBLY INSTRUCTIONS

HOSE ASSEMBLY EQUIPMENT

APPENDICES

O-Rings Seal Kit

FF10280-01

Includes metal box, o-rings for ORS -4 through -24, o-ring boss -04 through -32, Split flange -08 through -32, 24 packages with twelve 90 durometer nitrile o-rings per package. Packages can be ordered individually by part number listed.



Connection	Size	12 O-Ring Package Part No.	Individual O-Ring Part No.
ORS*	-04	FF10266-01-11	FF9446-11
ORS*	-06	FF10266-01-12	FF9446-12
ORS*	-08	FF10266-01-14	FF9446-14
ORS*	-10	FF10266-01-16	FF9446-16
ORS*	-12	FF10266-01-18	FF9446-18
ORS*	-16	FF10266-01-21	FF9446-21
ORS*	-20	FF10266-01-25	FF9446-25
ORS*	-24	FF10266-01-29	FF9446-29
O-Ring Boss	-04	FF10273-01-04	22617-4
O-Ring Boss	-05	FF10273-01-05	22617-5
O-Ring Boss	-06	FF10273-01-06	22617-6
O-Ring Boss	-08	FF10273-01-08	22617-8
O-Ring Boss	-10	FF10273-01-10	22617-10
O-Ring Boss	-12	FF10273-01-12	22617-12
O-Ring Boss	-16	FF10273-01-16	22617-16
O-Ring Boss	-20	FF10273-01-20	22617-20
O-Ring Boss	-24	FF10273-01-24	22617-24
O-Ring Boss	-32	FF10273-01-32	22617-32
Split Flange	-08	FF10266-01-210	FF9446-210
Split Flange	-12	FF10266-01-214	FF9446-214
Split Flange	-16	FF10266-01-219	FF9446-219
Split Flange	-20	FF10266-01-222	FF9446-222
Split Flange	-24	FF10266-01-225	FF9446-225
Split Flange	-32	FF10266-01-228	FF9446-228

*For ORS o-ring kit order part number: FF10265-01, only includes ORS o-rings.

BSPP Bonded Seal for DIN 3852-2 Ports

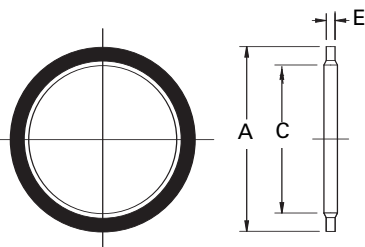

Bonded Seal Part Number	BSPP Thread Size	A Ref Inch	C Ref Inch	E Ref Inch
FF9895-02	1/8 -28	0.625	0.403	0.080
FF9895-04	1/4 -19	0.810	0.536	0.080
FF9895-06	3/8 -19	0.937	0.675	0.080
FF9895-08	1/2 -14	1.125	0.843	0.097
FF9895-10	5/8 -14	1.250	0.920	0.097
FF9895-12	3/4 -14	1.375	1.060	0.097
FF9895-16	1 -11	1.685	1.329	0.133
FF9895-20	1 1/4 -11	2.062	1.685	0.133
FF9895-24	1 1/2 -11	2.307	1.902	0.133
FF9895-32	2 -11	2.875	2.380	0.133

Material: Steel with bonded Nitrile (Buna-N) seal.

Designating Separate SAE Boss O-Rings

To order Eaton o-rings separately without fittings specify the size and material by using the o-ring base number and dash size. The charts below offer a simple method to assure the correct o-ring for your application.



O-Ring Base No.	Material	Operating Temperature Range
22617 (Standard)	90 Durometer Buna-N Nitrile Rubber	-30°F to +250°F (-34°C to +121°C)
22033	EPR Ethylene Propylene Rubber	-65°F to +212°F (-55°C to +100°C)
22068	Viton* Fluoroelastomer	-15°F to +400°F (-25°C to +205°C)
22012	Buna-N, Low Temperature Nitrile Rubber	-65°F to +225°F (-55°C to +107°C)

O-Ring Dash Size	Tube Size	A		E	
		mm	in	mm	in
-4	-04 (1/4)	8,9	.351	1,8	.072
-6	-06 (3/8)	11,9	.468	2,0	.078
-8	-08 (1/2)	16,3	.644	2,3	.087
-10	-10 (5/8)	19,3	.755	2,5	.097
-12	-12 (3/4)	23,4	.924	3,0	.116
-16	-16 (1)	29,7	1.171	3,0	.116
-20	-20 (1 1/4)	37,6	1.475	3,0	.118
-24	-24 (1 1/2)	43,7	1.720	3,0	.118

Designating Separate ORS O-Rings

To order Eaton o-rings separately without fittings specify the size and material by using the o-ring designator and o-ring base number. The charts to the right offer a simple method to assure the correct o-ring for your application.

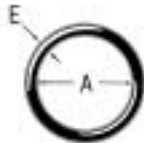

O-Ring Base No.	Material	Operating Temperature Range
FF9446 (Standard)	90 Durometer Buna-N Nitrile Rubber	-40°F to +250°F (-40°C to +121°C)
FF9807	EPR Ethylene Propylene Rubber	-65°F to +300°F (-55°C to +150°C)
22046	Viton Fluoroelastomer	-15°F to +400°F (-25°C to +205°C)
FF9855	Buna-N, Low Temperature Nitrile Rubber	-65°F to +225°F (-55°C to +107°C)
22546	Neoprene	-65°F to +300°F (-55°C to +150°C)

O-Ring Size Designation	ORS Tube Size	A		E	
		mm	in	mm	in
-11	-04	7,6	.301	1,8	.07
-12	-06	9,2	.364	1,8	.07
-14	-08	12,4	.489	1,8	.07
-16	-10	15,6	.614	1,8	.07
-18	-12	18,8	.739	1,8	.07
-21	-16	23,5	.926	1,8	.07
-25	-20	29,9	1.176	1,8	.07
-29	-24	37,8	1.489	1,8	.07

Adapters and Tube Fittings Index

Alphabetical Index

DESCRIPTION	PAGES
Adapters	196
Braze and weld to 37° flare	265
Braze and weld to split flange	263
BSPP to 37° flare	274
BSPT to 37° flare	275
Ermeto®	282
ISO 6149 to ORS	272
JIS 30° to 37° flare	275
Metric to 37° flare	269
O-Rings	199
Pipe to braze and weld	246
Pipe to 45° flare	243
Pipe to pipe	224
Pipe to SAE O-ring boss	244
Pipe to 37° flare	233
SAE flareless to 37° union	266
SAE O-ring to 37° flare	254
SAE split flange to SAE split flange	262
SAE split flange to 37° flare	259
SAE 37° (JIC) flare union	247
SAE Split Flange to ORS	257
Specials	268
Stainless Steel Adapters	276
Versil•Flare™ flare and flareless	267

DESCRIPTION	PAGES
Assembly Instructions	309
O-ring boss	316
ORS braze type tube fittings	313
ORS-TF tube fittings	311
ORS tube fittings	314
Pipe threads	314
SAE 37° (JIC)	314
Versil•Flare tube fittings	315
ORS Tube Fittings	208
ORS accessories	221
ORS braze type	209
ORS to Metric	273
ORS to NPTF	216
ORS to O-ring boss	212
ORS to ORS	218
ORS-TF	208

DESCRIPTION	PAGES
Technical Data	343
Assembly torque	376
BSPP threads	370
BSPT threads	370
Fluid Compatibility Chart (Hose, Seals, Metal)	349-355
Metric threads	367
Tube installation	379
Thread engagement dimensions	375
Through hole dimensions	363
Thread size chart	363
Thread style pressure performance	375
Tubing specifications	376
Versil•Flare Tube Fitting Connection	204

DESCRIPTION	PAGES
Configuration Index	198
Fluid Compatibility Chart (Hose, Seals, Metal)	349-355
How To Order	206
Numerical Index	197
O-Rings	192
O-Ring Kits	194
ORS Connection	203

SPECIALTY &
TRUCK HOSE

LOW & MEDIUM
PRESSURE HOSE

HIGH PRESSURE HOSE

HOSE FITTINGS

ADAPTERS &
TUBE FITTINGS

ACCESSORIES &
ASSEMBLY INSTRUCTIONS

HOSE ASSEMBLY
EQUIPMENT

APPENDICES

Adapter Part Index

PART NUMBER	PAGE	PART NUMBER	PAGE	PART NUMBER	PAGE	PART NUMBER	PAGE
15.000	273	2039	250	2240	233	202113	234
15.063	269	2040	226	2242	235	202114	234
15.117	270	2041	248	2243	236	202124	268
15.147	270	2041-1	248	2244	239	202232	265
15.163	270	2042	249	2246	244	202411	237
15.164	270	2042-1	249	2247	227	202413	238
15.165	270	2043	250	2249	239	202414	238
259-1290	281	2043-1	250	2250	238	202702	254
259-2021	279	2044	236	2251	229	202712	247
259-2022	280	2045	226	2252	229	202713	255
259-2023	279	2046	227	2253	231	202901	241
259-2024	280	2047	230	2254	231	203002	252
259-2027	280	2048	229	2255	231	203002-1	252
259-202702	281	2049	228	2256	230	203003	257
259-2039	280	2050	227	2257	230	203003-1	257
259-2062	281	2056	253	2266	255	203005	256
259-2071	280	2060	253	4624	263	203005-1	256
259-2081	277	2061	255	7015X	288	203006	240
259-2082	277	2061-1	255	7105X	287	203007	239
259-2083	277	2062	256	7129X	288	203008	252
259-2085	277	2062-1	256	7165X	287	203101	252
259-2087	278	2063	274	7205X	289	203102	252
259-2088	278	2066	245	7229X	288	203103	240
259-2089	278	2067	245	7255X	289	203104	241
259-2090	278	2067-1	245	7305X	288	203301	240
259-2091	278	2068	246	7306X	288	206209	255
259-2092	279	2068-1	246	7315X	290	206209-1	255
259-2096	279	2070	249	7325X	289	206801	246
259-2240	279	2071	250	7355X	290	206801-1	246
259-900605	281	2080	232	7405X	291	206804	246
1290	267	2081	225	7455X	291	206804-1	246
2000	243	2082	225	7505X	290	208006	232
2001	243	2083	224	7515X	291	208007	232
2002	244	2084	225	7605X	293	210212	253
2003	244	2085	228	7655X	293	210292	248
2004	268	2087	230	7705X	292	210294	266
2007	243	2088	228	7716X	292	221501	249
2015	224	2089	229	7755X	292	500023	261
2018	234	2090	232	7805X	292	500024	261
2020	253	2091	232	7924X	287	500025	259
2021	233	2092	231	8112X	287	500454	251
2022	235	2093	231	8165X	287	504089	262
2023	235	2096	227	71416	264	504095	251
2024	236	2214	256	71418	263	900598	223
2025	239	2215	249	71422	264	900598-1	223
2027	247	2216	245	71423	263	900599	248
2028	240	2216-1	245	73014	265	900605	267
2029	242	2220	223	73056	246	FC1102	264
2030	241	2222	226	200001	268	FC1132	264
2031	242	2229	224	202003	242	FC1229	209
2033	251	2239	234	202006	242	FC1851	208

SPECIALTY &
TRUCK HOSE

LOW & MEDIUM
PRESSURE HOSE

HIGH PRESSURE HOSE

HOSE FITTINGS

ADAPTERS &
TUBE FITTINGS

ACCESSORIES &
ASSEMBLY INSTRUCTIONS

HOSE ASSEMBLY
EQUIPMENT

APPENDICES

	PART NUMBER	PAGE	PART NUMBER	PAGE	PART NUMBER	PAGE	PART NUMBER	PAGE
SPECIALTY & TRUCK HOSE	FC2325	209	FF1981	269	FF2484T	273	FF6064T	258
	FC2326	212	FF1994T	219	FF2485T	272	FF6071T	259
	FC2875	267	FF2000T	218	FF2522T	259	FF6072T	259
	FF1010	223	FF2001T	217	FF2591	224	FF6073T	259
	FF1065	249	FF2030T	220	FF2593	275	FF9075	222
	FF1066	249	FF2031T	216	FF2742T	272	FF9173	266
	FF1159	246	FF2032T	217	FF2743T	272	FF9605	267
	FF1161	224	FF2033T	221	FF2744T	272	FF9766	222
	FF1162	228	FF2035T	220	FF2745T	272	FF9767	222
	FF1167	224	FF2068T	215	FF2746T	273	FF9768	221
LOW & MEDIUM PRESSURE HOSE	FF1315	266	FF2093T	217	FF5162	262	FF9863	222
	FF1327	268	FF2098T	219	FF5163	250	FF90102	208
	FF1353	269	FF2114T	221	FF5164	251	FF90103	208
	FF1354	269	FF2115T	211	FF5238	261	FF90396	273
	FF1851T	210	FF2127T	215	FF5239	260	GG106-NP	274
	FF1852T	213	FF2130T	212	FF5321	262	GG108-NP	271
	FF1854T	212	FF2133T	219	FF5539	260	GG110-NP	275
	FF1856T	211	FF2137	223	FF5540	262	GG308-NP	271
	FF1857T	221	FF2138	223	FF5541	260	GG310-NP	275
	FF1858T	211	FF2144T	219	FF5943T	257		
HIGH PRESSURE HOSE	FF1861T	215	FF2151T	218	FF5945T	258		
	FF1865T	216	FF2174T	220	FF5946T	258		
	FF1868T	214	FF2209T	218	FF6001T	257		
	FF1898T	220	FF2211T	212	FF6002T	257		
	FF1922T	210	FF2227T	214	FF6033T	257		
	FF1939	273	FF2281T	218	FF6062T	258		
	FF1980	269	FF2313T	218	FF6063T	258		

Configuration Index

ORS-TF



FC1851
page 208



FF90102
page 208



FF90103
page 208

ORS BRAZE TYPE



FC1229
page 209



FC2325
page 209



FF1922T
page 210

ORS BRAZE TYPE (CONTINUED)

ORS/O-RING BOSS



FF1851
page 210



FF1856T
page 211

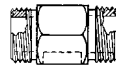

FF1858T
page 211

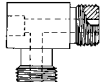

FF2115T
page 211



FC2326,
page 212



FF1852T
page 213



F2211T
page 212



FF1854T
page 212

ORS/O-RING BOSS (CONTINUED)

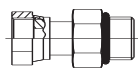

FF2130T
page 212

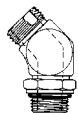

FF2068T
page 215



FF1868T
page 214

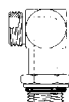

FF2227T
page 214



FF1861T
page 215

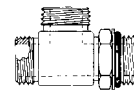

FF1865
page 216



FF2127T
page 215

ORS-NPTF



FF2031T
page 216



FF2093T
page 217

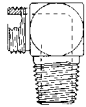

FF2032T
page 217



FF2001T
page 217

ORS TO SAE 37° (JIC) FLARE

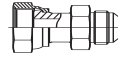

FF2209T
page 218

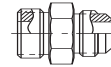

FF2313T
page 218

ORS/ORS



FF2000T
page 218

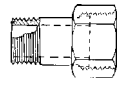

FF2281T
page 218



FF1994T
page 219



FF2133T
page 219



FF2144T
page 219



FF2098T
page 219

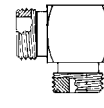

FF2035T
page 220

ORS/ORS (CONTINUED)

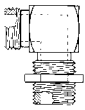

FF2030T
page 220



FF1898T
page 220

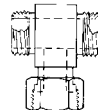

FF1857T
page 221

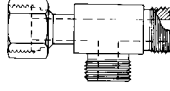

FF2114T
page 221

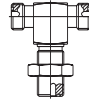

FF2033T
page 221

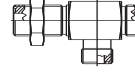

FF2174T
page 220



FF9768
page 221

ORS ACCESSORIES

ORS ACCESSORIES (CONTINUED)



FF9767
page 222



FF9863
page 222



FF9766
page 222



FF9075
ORS Silver
Braze Ring
page 222

PIPE TO PIPE

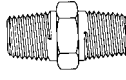

2083
page 224

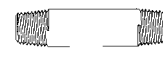

2084
page 225



2015
page 224

PIPE TO PIPE (CONTINUED)



2081
page 225

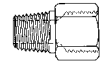

2040
page 226



2082
page 225



2222
page 226

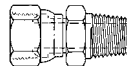

2045
page 226

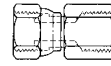

2045
page 227



2096
page 227

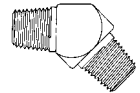

2247
page 227

PIPE TO PIPE (CONTINUED)

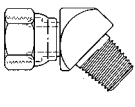

2049
page 228

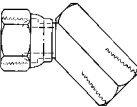

2050
page 227

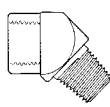

2068
page 228

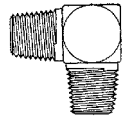

2085
page 228

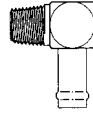

FF1162
page 228

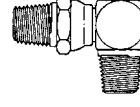

2251
page 229

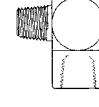

2089
page 229

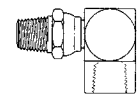

2252
page 229

PIPE TO PIPE (CONTINUED)



2047
page 230

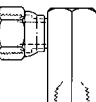

2048
page 229



2087
page 230

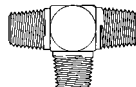

2257
page 230

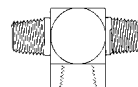

2256
page 230

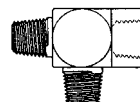

2093
page 231

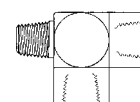

2092
page 231

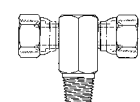

2254
page 231

SPECIALTY &
TRUCK HOSE

LOW & MEDIUM
PRESSURE HOSE

HIGH PRESSURE HOSE

HOSE FITTINGS

ADAPTERS &
TUBE FITTINGS

ACCESSORIES &
ASSEMBLY INSTRUCTIONS

HOSE ASSEMBLY
EQUIPMENT

APPENDICES

PIPE TO PIPE (CONTINUED)

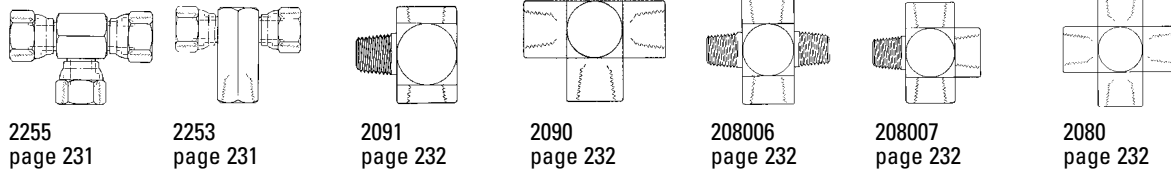

2255 page 231 2253 page 231 2091 page 232 2090 page 232 208006 page 232 208007 page 232 2080 page 232

PIPE TO 37° FLARE

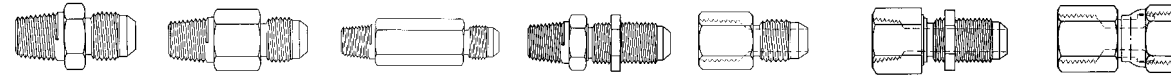

2021 page 233 202113 page 234 202114 page 234 2240 page 233 2022 page 235 2239 page 234 2242 page 235

PIPE TO 37° FLARE (CONTINUED)

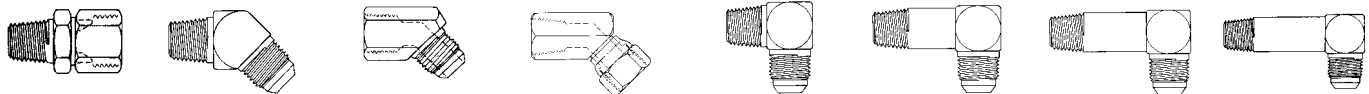

2018 page 234 2023 page 236 2044 page 236 2243 page 236 2024 page 237 202411 page 237 202413 page 238 202414 page 238

PIPE TO 37° FLARE (CONTINUED)

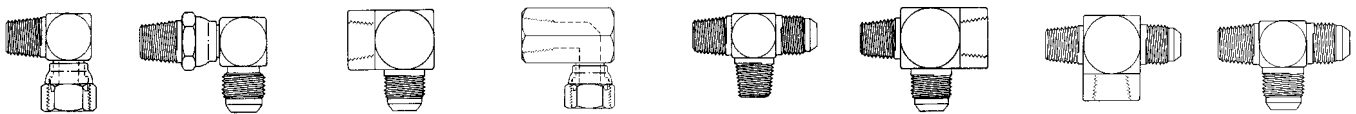

2250 page 238 2249 page 239 2025 page 239 2244 page 239 203007 page 239 203301 page 240 203103 page 240 2028 page 240

PIPE TO 37° FLARE (CONTINUED)

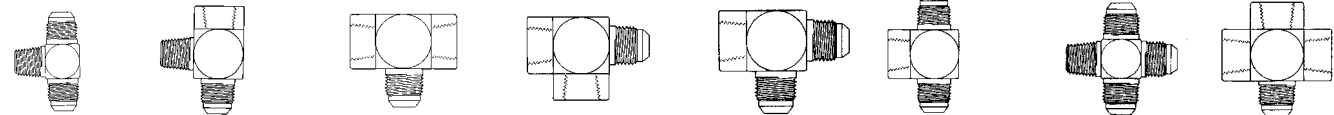

2030 page 241 203006 page 240 202901 page 241 203104 page 241 2029 page 242 2031 page 242 202003 page 242 202006 page 242

PIPE TO 45° FLARE

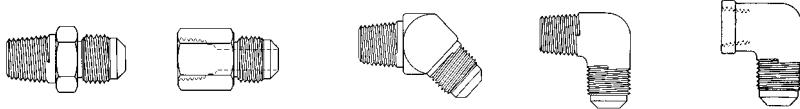

2000 page 243 2001 page 243 2007 page 243 2003 page 244 2002 page 244

PIPE TO SAE O-RING BOSS



2246 page 244

PIPE TO SAE O-RING BOSS (CONTINUED)

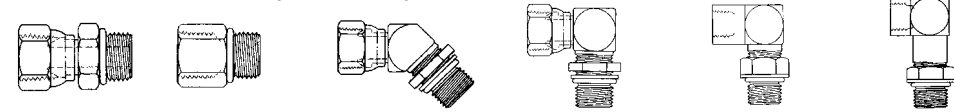

2066 page 245 2216 page 245 2067 page 245 2068 page 246 206801 page 246 206804 page 246

PIPE TO BRAZE AND WELD



73056 page 246 FF1159 page 246

SAE 37° (JIC) FLARE UNION

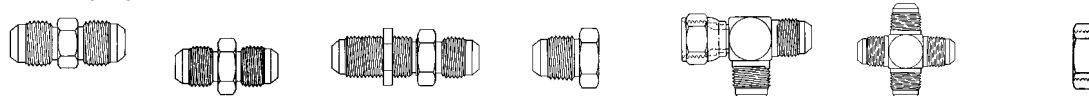

2027 page 247 202712 page 247 2041 page 248 900599 page 248 203102 page 252 2020 page 253 210212 page 253

SPECIALTY & TRUCK HOSE

LOW & MEDIUM PRESSURE HOSE

HIGH PRESSURE HOSE

HOSE FITTINGS

ADAPTERS & TUBE FITTINGS

ACCESSORIES & ASSEMBLY INSTRUCTIONS

HOSE ASSEMBLY EQUIPMENT

APPENDICES

SAE 37° (JIC) FLARE UNION (CONTINUED)

210292 page 248	2215 page 249	221501 page 249	2042 page 249	2070 page 249	2039 page 250	2043 page 250	2071 page 250

SAE 37° (JIC) FLARE UNION (CONTINUED)

500454 page 251	FF5163 page 250	504095 page 251	FF5164 page 251	2033 page 251	203002 page 252	203008 page 252	203101 page 252

SAE 45° FLARE UNION

ORB/ORB

2056 page 253	2060 page 253	2220 page 223	2229 page 224	FF2591 page 224

SAE O-RING TO 37° FLARE

202702 page 254	202713 page 255	2266 page 255	2061 page 255	2052 page 256	206209 page 255	203005 page 256	203003 page 251	2214 page 256

SAE SPLIT FLANGE TO ORS

FF5943T page 257	FF6001T page 257	FF6002T page 257	FF5946T page 258	FF5945T page 258	FF6062T page 258	FF6063T page 258

SAE SPLIT FLANGE TO ORS (CONTINUED)

FF6064T page 258	FF6071T page 259	FF6072T page 259	FF6073T page 259	FF2522T page 259	FF6033T page 257

SAE SPLIT FLANGE TO 37° FLARE

500025 page 259	FF5239 page 260	FF5541 page 260	500023 page 261	FF5238 page 261	FF5539 page 260	500024 page 261	FF5162 page 262	FF5540 page 262

SAE SPLIT FLANGE TO SAE SPLIT FLANGE

SAE FLARELESS TO 37° UNION

FLARE AND FLARELESS

504089 page 262	FF5321 page 262	FF1315 page 266	210294 page 266	FF9173 page 266	FC2875 page 267	FF9605 page 267	1290 page 267	900605 page 268

BRAZE & WELD TO SPLIT FLANGE

BRAZE & WELD TO 37° FLARE

71418 page 263	4624 page 263	71423 page 263	71416 page 264	71422 page 264	FC1102 page 264	FC1132 page 264	73014 page 265	202232 page 265

SPECIALTY & TRUCK HOSE

LOW & MEDIUM PRESSURE HOSE

HIGH PRESSURE HOSE

HOSE FITTINGS

ADAPTERS & TUBE FITTINGS

HOSE ASSEMBLY INSTRUCTIONS

ACCESSORIES & ASSEMBLY INSTRUCTIONS

HOSE ASSEMBLY EQUIPMENT

APPENDICES

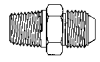
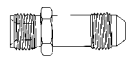
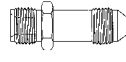
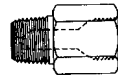
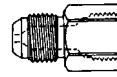
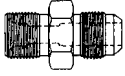
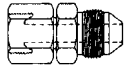
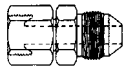
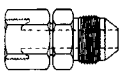
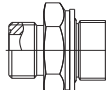
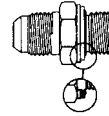
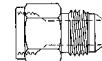
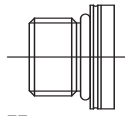
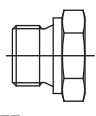
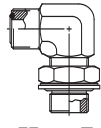
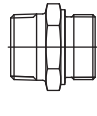
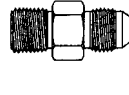
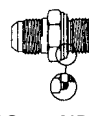
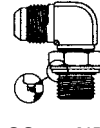
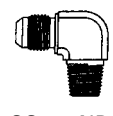
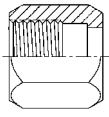
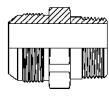
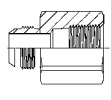
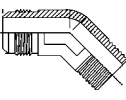
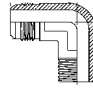
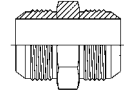
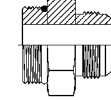
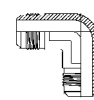
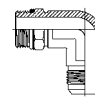
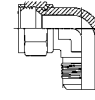
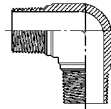
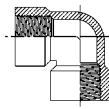
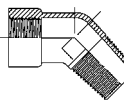
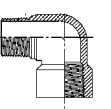
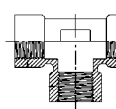
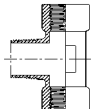
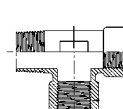
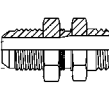
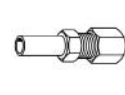
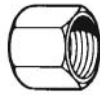
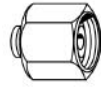
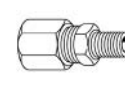
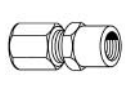
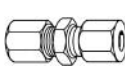
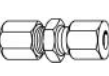
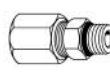
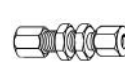
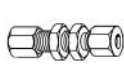
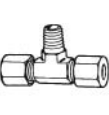
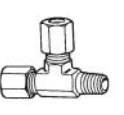
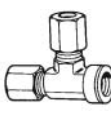
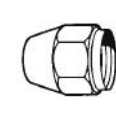
SPECIALS2004
page 268202124/FF1327
page 268FT1353/FF1354
page 269200001
page 268FF1980
page 269FF1981
page 26915.063
page 26915.147
page 270**METRIC THREAD****METRIC THREAD**15.117
page 27015.164
page 27015.163
page 27015.165
page 271FF2485T
page 272GG108-NP
page 271GG308-NP
page 271FF2593
page 275**JIS 30° THREAD****ORS TO METRIC**FF90396
page 273FF1939
page 273FF2484T
page 27315.000
page 273**BSPP THREAD**2063
page 274GG106-NP
page 274GG306-NP
page 274**BSPT THREAD**GG110-NP
page 275GG310-NP
page 275**STAINLESS STEEL**259-1290
page 281259-2021
page 279259-2022
page 280259-2023
page 279259-2024
page 280259-2027
page 280259-202702
page 281259-2039
page 280259-2062
page 281259-2071
page 280**STAINLESS STEEL**259-2081
page 277259-2082
page 277259-2083
page 277259-2085
page 277259-2087
page 278259-2088
page 278259-2089
page 278259-2090
page 278259-2091
page 278259-2092
page 279**STAINLESS STEEL**259-2096
page 279259-2240
page 279259-900605
page 2817015X
page 2887105X
page 2877129x
page 2887165x
page 2877205x
page 2897229x
page 2887255x
page 289**ERMETO****ERMETO**7305x
page 2887306x
page 2887315x
page 2907325x
page 2897325x
page 2897355x
page 2907405x
page 2917455x
page 2917505x
page 290**ERMETO**7515x
page 2917605x
page 2937655x
page 2937716x
page 2927755x
page 2927805x
page 2927924x
page 2878112x
page 2878165x
page 287SPECIALTY &
TRUCK HOSELOW & MEDIUM
PRESSURE HOSE

HIGH PRESSURE HOSE

HOSE FITTINGS

ADAPTERS &
TUBE FITTINGSACCESSORIES &
ASSEMBLY INSTRUCTIONSHOSE ASSEMBLY
EQUIPMENT

APPENDICES

The Eaton ORS Connection is the Universal Answer to Troublesome Fluid Leakage Problems

ORS Connection Hose Assembly

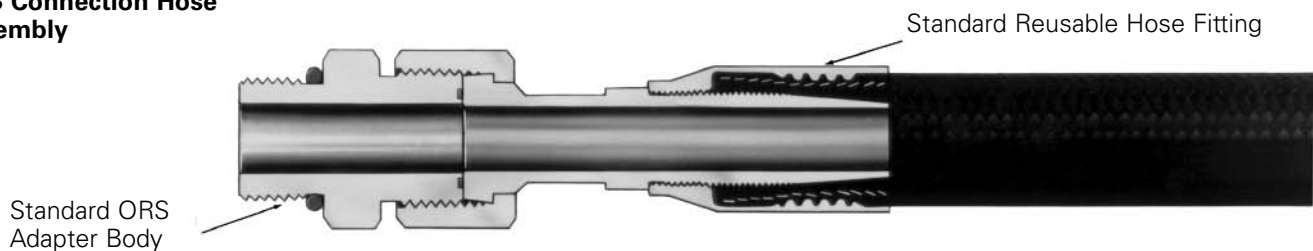

ORS TF Tube Assembly



ORS Braze Type Tube Assembly

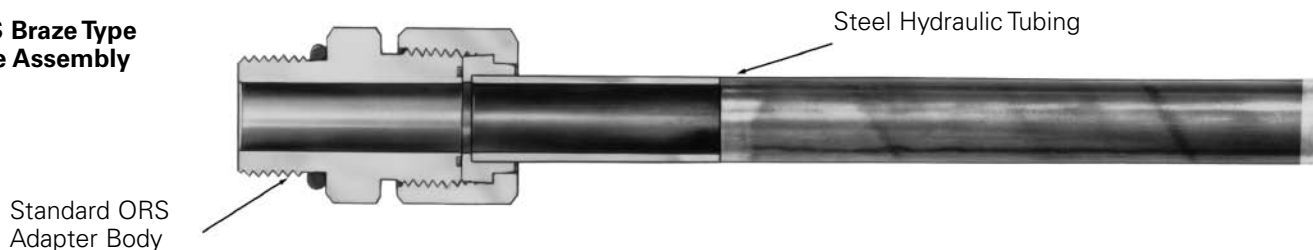

Hose Assemblies

The ORS connection can be used with flexible hydraulic hose, combining the reusability of the hose fitting and the ORS connection. The result is the ultimate reusable fitting.

Tube Assemblies

The ORS connection can be attached to hydraulic tubing to make a tube assembly. Two methods of attachment are available.

1. ORS-TF: The ORS female can be jointed directly to steel tubing with the patented ORS-TF (wedge-type) tube fitting, another Eaton innovation. The fitting becomes an integral part of your system at a fraction of the time and expense brazing requires.

The versatility these options provides make ORS the only connection you need for high-pressure situations.

It attaches to most types of fluid conveying lines, controlling most types of fluid, facing the toughest conditions.

2. ORS-Braze Type: The ORS component can be brazed to hydraulic tubing.

SPECIALTY & TRUCK HOSE

LOW & MEDIUM PRESSURE HOSE

HIGH PRESSURE HOSE

HOSE FITTINGS

ADAPTERS & TUBE FITTINGS

ACCESSORIES & ASSEMBLY INSTRUCTIONS

HOSE ASSEMBLY EQUIPMENT

APPENDICES

**Versil-Flare Flareless and
Versil-Flare SAE 37° Flared type**

*both styles use the same
SAE 37° flared body*

Before Connection

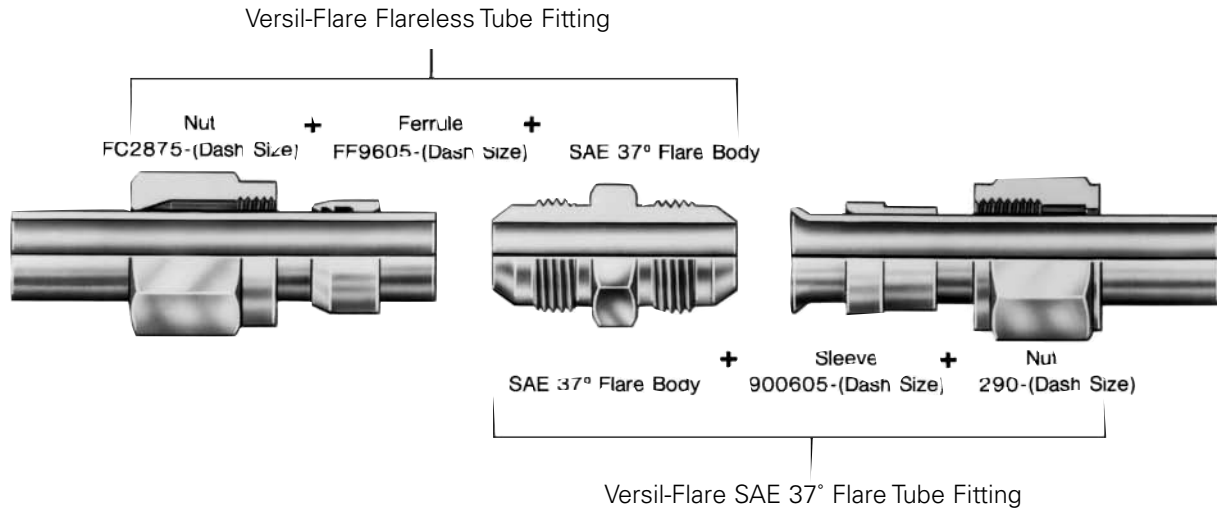

After Connection

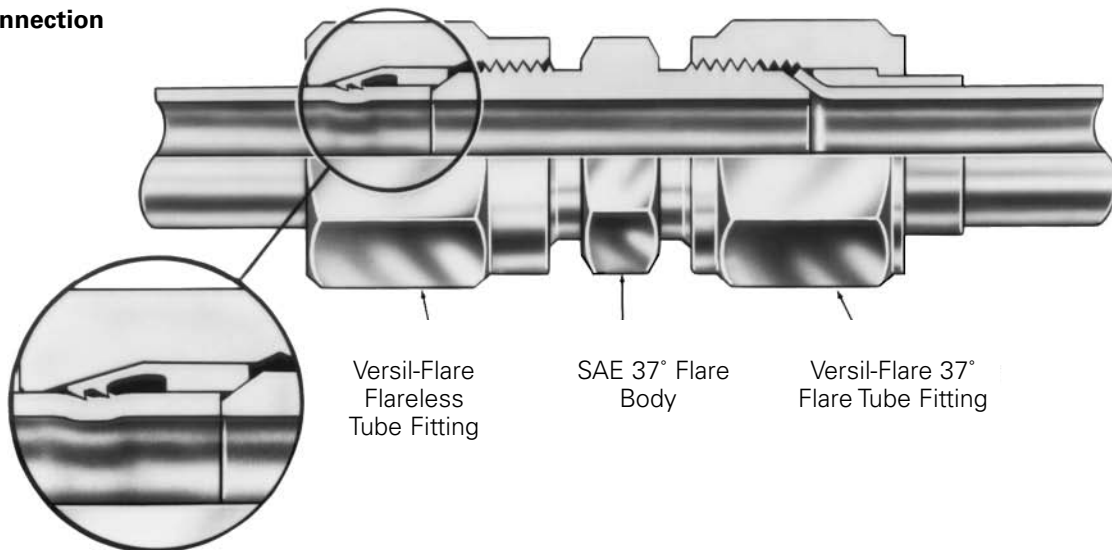

SPECIALTY & TRUCK HOSE
LOW & MEDIUM PRESSURE HOSE
HIGH PRESSURE HOSE
HOSE FITTINGS
ADAPTERS & TUBE FITTINGS
ACCESSORIES & ASSEMBLY INSTRUCTIONS
HOSE ASSEMBLY EQUIPMENT
APPENDICES

One inventory of bodies (any standard SAE 37° flare fitting) allows both flareless and flared type connection of standard steel hydraulic tubing. It is no longer necessary

to inventory flared tube fittings plus the special bodies, nuts and sleeves for flareless tube fittings. The Eaton total tube fitting concept reduces inventory expense.

Eaton Versil-Flare Flareless Tube Fitting

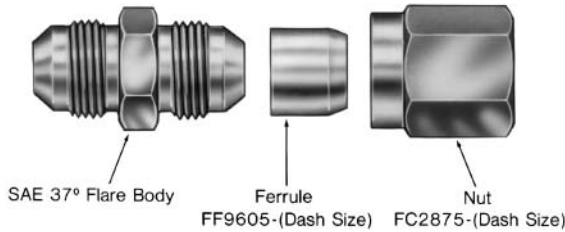

The Eaton Versil-Flare Flareless Tube Fitting can use any standard SAE 37° male flare adapter or hose fitting as a body. This eliminates the need to inventory special flareless tube fitting bodies and results in reduced inventory expense. Eaton Versil-Flare Flareless Tube Fittings are available in size from 3/16" tube O.D. to 2" tube O.D.

Presetting tools and extra assembly time are eliminat-

ed because there's no need for flaring, special preparation or presetting with the Eaton Versil-Flare Flareless Tube Fitting. The chance of assembly error is reduced because the ferrule can be installed only one way and assembly is the same for all sizes and tube wall thicknesses. This assures a tight joint every time. These features improve production rates.

Eaton Versil-Flare Flared Tube Fitting

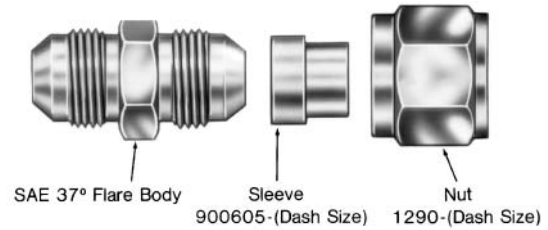

The Eaton industrial standard three piece flare type tube fitting can be used on the full range of standard steel hydraulic tubing in various wall thicknesses from 3/16" tube O.D. to 2" tube O.D. All three components are constructed from high quality zinc plated steel for long service life.

The standard SAE 37° flare angle is used to produce a highly efficient seal under hydraulic pressures. The sleeve is used to help support the tube and absorb vibration.

Assembly is easy. A properly sized wrench and flaring tool are all that is necessary. This is important in tight locations. Eaton standard SAE 37° flare type fittings can also be disassembled and re-assembled repeatedly.

Eaton quality is built into every component to assure leakproof connections.

The Eaton standard SAE 37° flare type tube fitting conforms to the following hydraulic tube fitting standards. Military specification, MIL-F-18866 and Society of Automotive Engineers, SAE J514.

Tubing selection and sizing

Eaton Versil-Flare Flareless and standard SAE 37° flare type, tube fittings can be used with SAE J-525 electric resistance welded, cold worked annealed, SAE J-524 seamless annealed tubing and SAE J527 brazed double wall low carbon steel tubing. SAE J356

welded flash controlled normalized steel tubing can only be used with Eaton Versil-Flare Flareless tube fittings. **The maximum hardness of the above tubing should not exceed Rockwell B65.** Selection of proper tubing material, size and wall thickness depends

on corrosion conditions, pressure and flow requirements and other operating requirements of the system.

Adapter Part Numbers

Adapter part numbers consist of a base number followed by a size designation. If the part number contains a "T" character between the base number and size designator, the first size designator signifies the tube size.

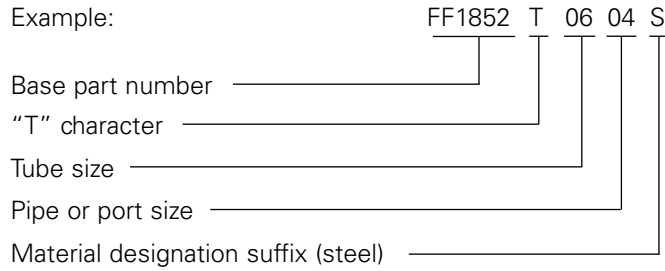

If the part number does not contain a "T" character between the base number and the size description, the first size designation signifies the port size.

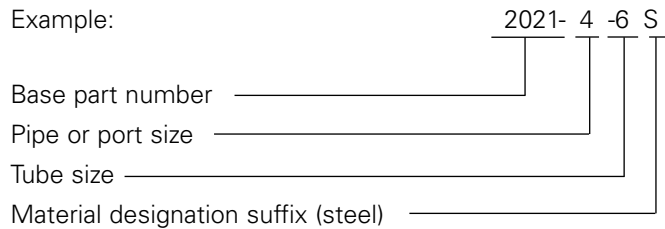

How to Order Adapters

Adapters are ordered using the complete part number as shown on the adapter pages.

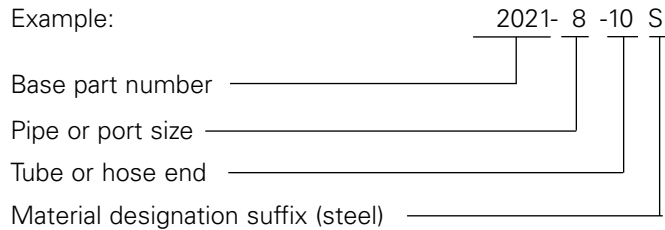

ORS Adapter Conversion*

ORS adapters have been replaced with the half dovetail groove design. The half dovetail groove is manufactured with an angle on the OD wall. This angle captures the o-ring for maximum retention. For ease of installation, a half dovetail groove installation tool may be used.

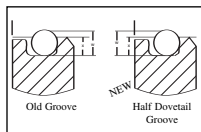

Half Dovetail Groove Installation Tool

The half dovetail groove installation tool compresses the o-ring, allowing it to easily slide into the groove in the adapter. Use of the tool maximizes efficiency and minimizes any fatigue that may be associated with repeated insertions over an extended period of time. One tool is required per dash size (or by adapter size). Each tool comes with an illustrated instruction sheet. Tools are available by using the following part numbers: FT1405-04, FT1405-06, FT1405-08, FT1405-10, FT1405-12, FT1405-16, FT1405-20, FT1405-24.



*Eaton reserves the right to use straight groove on some ORS.

How to order ORS Adapters and Tube Fittings

ORS tube fitting body with o-ring, locknut and washer, where applicable.

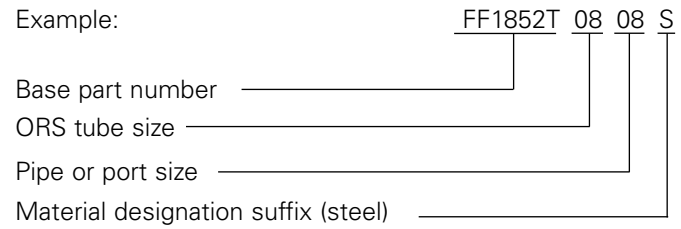

ORS tube fitting body without o-rings

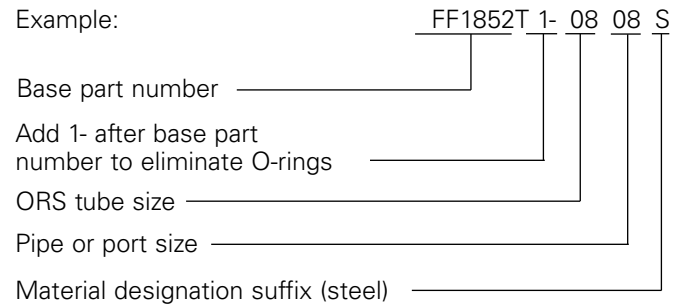

ORS bulkhead tube fitting body without bulkhead nut or o-rings

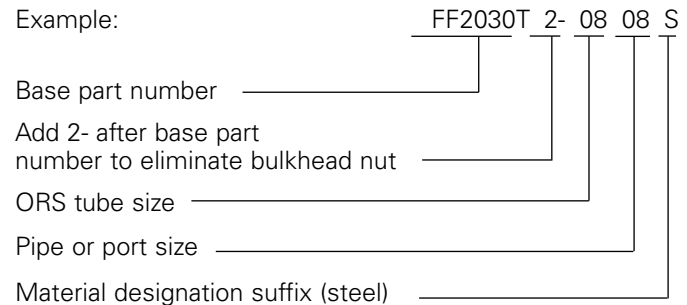

ORS-TF Tube Fitting Components

ORS-TF tube fittings, nut, ferrules, and sleeves can be ordered under the following kit part number:

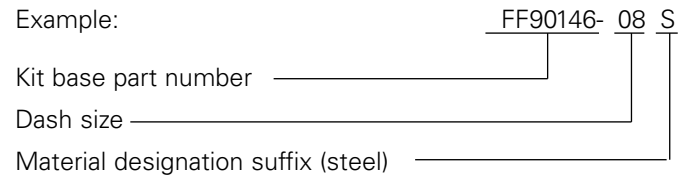

By ordering a single part number in kit form, you will receive the components ready to be assembled to an ORS tube fitting body:

- Example: FF90146-08S includes:
- FC1851-08S (ORS-TF Nut)
 - FF90102-08S (ORS-TF Ferrule)
 - FF90103-08S (ORS-TF Sleeve)

Continued on next page.

How to order ORS Adapters and Tube Fittings (cont.)

Nuts and Shoulders (Braze Type)

Nuts and shoulders can be ordered separately. Simply use the base number, dash size, and material designation.

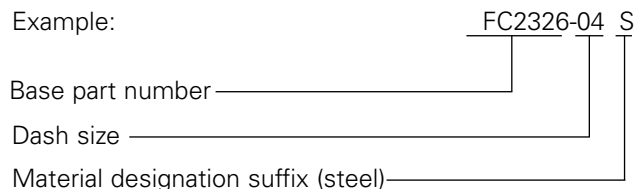

O-Rings

Buna-N O-rings are standard. Other materials may also be specified by adding a material designator prefix if the part number begins with a numeric, and a material designator suffix if the part number begins with an alpha character. In all cases, the suffix "S" shall be omitted.

MATERIAL DESIGNATION PREFIX/SUFFIX	MATERIAL	OPERATING TEMPERATURE RANGE
S (standard)	90 Durometer Buna-N Nitrile Rubber	-40°F to +250°F (-40°C to +121°C)
212	EPR Ethylene Propylene Rubber	-65°F to +300°F (-55°C to +150°C)
213	Viton Fluoroelastomer	-15°F to +400°F (-26°C to +204°C)
214	Buna-N, Low Temperature Nitrile Rubber	-65°F to +225°F (-55°C to +100°C)
352	Neoprene	-65°F to +300°F (-55°C to +150°C)



O-rings can be ordered separately.

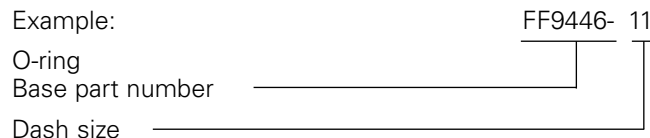

Body Material

Steel is standard. Other materials may also be specified by adding a material designator prefix if the part number begins with a numeric, and a material designator suffix if the part number begins with an alpha character. In all cases, the suffix "S" shall be omitted.

MATERIAL DESIGNATOR PREFIX/SUFFIX	MATERIAL
B (suffix only)	Brass
259	316-Stainless
4	Monel
S	Steel

How to Order Conversion Adapters BSPP/BSPT

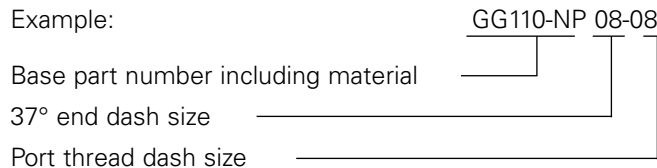

Metric

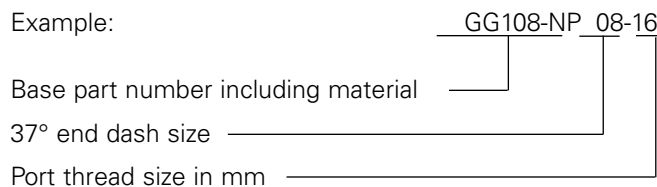

Dimensions

Eaton tube fittings are ordinarily designed and produced to the functional requirements set forth in SAE Standards J512, J513, J514, J1926 and J1453. However, in some cases the envelope dimensions of certain components vary slightly from cataloged or SAE referenced dimensions. The SAE reference numbers and fitting descriptions given are in accordance with SAE Standard J846.

Availability

All items listed in the current price schedule are normally carried in stock. Price and delivery of non-stocked and special parts may be obtained from your Eaton Sales Representative or Distributor.

Loctite* Vibra-Seal 516 for External Pipe Threads

Loctite Vibra-Seal has the following characteristics:

- Non-hardening thread sealant
- Resists shredding and peeling during assembly
- Can be reused up to 5 times without recoating
- Provides resistance to vibrational loosening
- Excellent resistance to solvents and oils
- Operating temperatures range -65°F to +250°F

Machine applied so that it leaves first 1/2 to 2 threads uncovered for ease of assembly. Because of the excellent characteristics of this product, we are offering Loctite Vibra-Seal on all of our parts that have male pipe threads. Factory applied Loctite for external pipe threads may be ordered for steel parts by adding the prefix "307-" to the completed part number, and dropping suffix "S" if the part number begins with a numeral. Example: 307-2021-8-8. If the part number begins with an alpha character, add the suffix "-307" to the completed part number and drop the suffix "S". Example: FF2031T0606-307.

*Loctite is a trademark of Henkel Corporation.

ORS-TF Tube Fittings

The patented* ORS-TF tube fitting utilizing the ORS-TF nut, ferrule and sleeve can be joined directly to steel tubing to solve your fluid leakage problems. It does not require the time and expense of brazing and provides the advantage of repetitive reuse. It is a compression type fitting that works on a variety of tubing (See page 376 for tubing specifications). See page 309 for assembly instructions.

ORS-TF Kit Part No. FF90146-(Size)

Includes:

- FC1851 ORS-TF Nut
- FF90102 ORS-TF Ferrule
- FF90103 ORS-TF Sleeve

*Patent #5,217,261

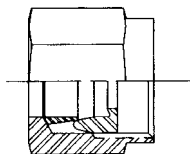

ORS-TF Nut Part No. FC1851- (Size)

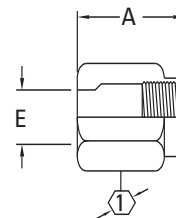

Dash Size	Tube O.D.		Thread T1	A		E		①	
	mm	in		mm	in	mm	in	mm	in
04S	6,3	0.25	9/16-18	21,3	0.84	6,6	0.26	17,5	0.69
06S	9,6	0.38	11/16-16	23,6	0.93	9,6	0.38	20,6	0.81
08S	12,7	0.50	13/16-16	26,9	1.06	12,9	0.51	23,9	0.94
10S	16,0	0.63	1-14	28,7	1.13	16,0	0.63	28,4	1.12
12S	19,0	0.75	13/16-12	32,5	1.28	19,3	0.76	35,0	1.38
16S	25,4	1.00	17/16-12	34,3	1.35	25,6	1.01	41,1	1.62
20S	31,7	1.25	111/16-12	35,8	1.41	32,0	1.26	47,7	1.88
24S	38,1	1.50	2-12	37,3	1.47	38,3	1.51	57,1	2.25

ORS-TF Ferrule Part No. FF90102- (Size)

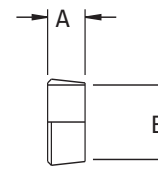

Dash Size	Tube O.D.		A		E	
	mm	in	mm	in	mm	in
04S	6,3	0.25	6,3	.25	6,6	0.26
06S	9,6	0.38	6,3	0.25	9,6	0.38
08S	12,7	0.50	7,6	1.50	12,9	0.51
10S	16,0	0.63	7,6	1.50	16,0	0.63
12S	19,0	0.75	7,6	1.50	19,3	0.76
16S	25,4	1.00	7,6	1.50	25,6	1.01
20S	31,7	1.25	7,6	1.50	32,0	1.26
24S	38,1	1.50	7,6	1.50	38,3	1.51

ORS-TF Sleeve Part No. FF90103- (Size)

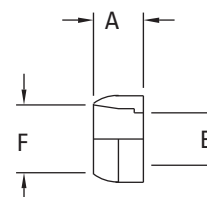

Dash Size	Tube O.D.		A		E		F	
	mm	in	mm	in	mm	in	mm	in
04S	6,3	0.25	8,1	0.32	4,3	0.17	6,3	0.25
06S	9,6	0.38	8,6	0.34	6,6	0.26	9,6	0.38
08S	12,7	0.50	9,4	0.37	9,6	0.38	12,7	0.50
10S	16,0	0.63	10,2	0.40	12,2	0.48	16,0	0.63
12S	19,0	0.75	11,2	0.44	15,5	0.61	19,3	0.76
16S	25,4	1.00	12,7	0.50	20,6	0.81	25,4	1.00
20S	31,7	1.25	14,2	0.56	26,7	1.05	32,0	1.26
24S	38,1	1.50	15,7	0.62	32,0	1.26	38,3	1.51

Material: Corrosion-resistant plated steel.

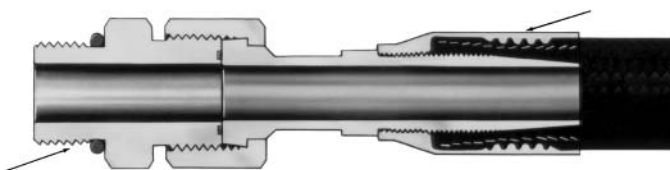

Keep It Simple and Clean with ORS

SPECIALTY & TRUCK HOSE
 LOW & MEDIUM PRESSURE HOSE
 HIGH PRESSURE HOSE
 HOSE FITTINGS
 ADAPTERS & TUBE FITTINGS
 ACCESSORIES & ASSEMBLY INSTRUCTIONS
 HOSE ASSEMBLY EQUIPMENT
 APPENDICES

ORS Braze Type

ORS-BR Shoulder Internal Braze

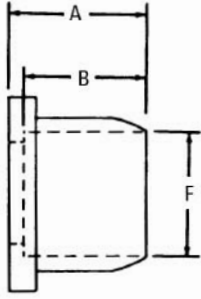

CAUTION

In applications exceeding +480°F (such as during brazing) order the oil-coated/non-plated nut by using part number FC1857-Size-186. When plating is heated above +480°F, toxic gases are given off.

Part No. FC1229- (Dash size)* (Ref. SAE 520115)

Dash Size	Tube O.D.		A		B		F	
	mm	in	mm	in	mm	in	mm	in
0404S	6,4	0.25	7,4	0.29	6,4	0.25	6,4	0.25
0604S	9,7	0.38	8,4	0.33	6,4	0.25	6,4	0.25
0606S	9,7	0.38	7,4	0.29	6,4	0.25	9,7	0.38
0806S	12,7	0.50	9,9	0.39	6,4	0.25	9,7	0.38
0808S	12,7	0.50	10,7	0.42	9,7	0.38	12,7	0.50
1008S	16,0	0.63	14,5	0.57	9,7	0.38	12,7	0.50
1208S	12,7	0.50	15,5	0.61	9,7	0.38	12,7	0.50
1010S	16,0	0.63	10,7	0.42	9,7	0.38	15,7	0.62
1210S	19,0	0.75	15,5	0.61	9,7	0.38	15,7	0.62
1212S	19,0	0.75	11,2	0.44	9,7	0.38	19,0	0.75
1414S	22,3	0.88	17,3	0.68	15,7	0.62	22,3	0.88
1612S	25,4	1.00	14,0	0.55	9,7	0.38	19,0	0.75
1614S	25,4	1.00	14,2	0.56	11,2	0.44	22,3	0.88
1616S	25,4	1.00	14,2	0.56	12,7	0.50	25,4	1.00
2016S	31,8	1.25	17,3	0.68	12,7	0.50	25,4	1.00
2020S	31,8	1.25	14,2	0.56	12,7	0.50	31,8	1.25
2420S	38,1	1.50	18,8	0.74	12,7	0.50	31,8	1.25
2424S	38,1	1.50	14,2	0.56	12,7	0.50	38,1	1.50

ORS-BR Shoulder External Braze/Weld

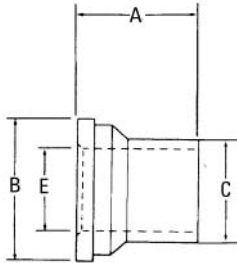

CAUTION

In applications exceeding +480°F (such as during brazing) order the oil-coated/non-plated nut by using part number FC1857-Size-186. When plating is heated above +480°F, toxic gases are given off.

Part No. FC2325- (Dash size)* (Ref. SAE 520172)

Dash Size	Tube O.D.		A		B		C		E	
	mm	in	mm	in	mm	in	mm	in	mm	in
0404S	6,4	0.25	22,3	0.88	12,7	0.50	6,4	0.25	4,3	0.17
0604S	9,7	0.38	24,4	0.96	15,7	0.62	6,4	0.25	4,0	0.16
0606S	9,7	0.38	24,4	0.96	15,7	0.62	9,7	0.38	6,6	0.26
0806S	12,7	0.50	28,5	1.12	18,8	0.74	9,7	0.38	6,6	0.26
0808S	12,7	0.50	31,8	1.25	18,8	0.74	12,7	0.50	9,1	0.36
1008S	16,0	0.63	34,0	1.34	23,4	0.92	12,7	0.50	9,1	0.36
1010S	16,0	0.63	34,0	1.34	23,4	0.92	15,7	0.62	11,4	0.45
1210S	19,0	0.75	36,6	1.44	27,7	1.09	15,7	0.62	11,4	0.45
1212S	19,0	0.75	36,6	1.44	27,7	1.09	19,0	0.75	14,0	0.55
1612S	25,4	1.00	38,3	1.51	34,0	1.34	19,0	0.75	14,0	0.55
1616S	25,4	1.00	41,4	1.63	34,0	1.34	25,4	1.00	19,8	0.78
2016S	31,8	1.25	41,4	1.63	40,4	1.59	25,4	1.00	19,8	0.78
2020S	31,8	1.25	41,4	1.63	40,4	1.59	31,8	1.25	26,7	1.05
2416S	38,1	1.50	41,4	1.63	48,5	1.91	25,4	1.00	19,8	0.78
2424S	38,1	1.50	41,4	1.63	48,5	1.91	38,1	1.50	32,0	1.26

*Eaton braze counterbores are dimensioned for sized or emerged tubing. If tubing is used as received, contact Eaton for appropriate part number.

SPECIALTY & TRUCK HOSE

LOW & MEDIUM PRESSURE HOSE

HIGH PRESSURE HOSE

HOSE FITTINGS

ADAPTERS & TUBE FITTINGS

ACCESSORIES & ASSEMBLY INSTRUCTIONS

HOSE ASSEMBLY EQUIPMENT

APPENDICES

ORS Bulkhead Male/Braze Adapter

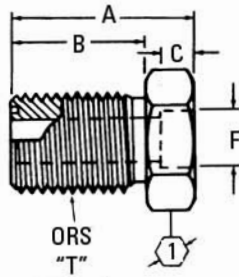

Thread

Part No. FF1922T(Size)* (Ref. SAE 520604)

Dash Size	Tube O.D.		Thread T1	A		B		C		D		①
	mm	in		mm	in	mm	in	mm	in	mm	in	
0404S	6,4	0.25	9/16-18	40,9	1.61	31,5	1.24	6,4	0.25	6,4	0.25	0.81
0606S	9,7	0.38	1 ¹ /16-16	43,7	1.72	34,0	1.34	6,4	0.25	9,7	0.38	1.00
0808S	12,7	0.50	1 ³ /16-16	49,3	1.94	36,6	1.44	9,7	0.38	12,7	0.50	1.12
0810S	12,7	0.50	1 ³ /16-16	49,3	1.94	36,6	1.44	9,7	0.38	15,7	0.62	1.12
1010S	16,0	0.63	1-14	53,6	2.11	40,6	1.60	9,7	0.38	15,7	0.62	1.31
1212S	19,0	0.75	1 ³ /16-12	55,4	2.18	41,6	1.64	9,7	0.38	19,0	0.75	1.50
1214S	19,0	0.75	1 ³ /16-12	55,4	2.18	41,6	1.64	9,7	0.38	22,3	0.88	1.50
1616S	25,4	1.00	1 ⁷ /16-12	61,7	2.43	42,2	1.66	12,7	0.50	25,4	1.00	1.75
2020S	31,8	1.25	1 ¹¹ /16-12	61,7	2.43	42,2	1.66	12,7	0.50	31,8	1.25	2.00
2024S	31,8	1.25	1 ¹¹ /16-12	61,7	2.43	42,2	1.66	12,7	0.50	38,1	1.50	2.12
2424S	38,1	1.50	2-12	61,7	2.43	42,2	1.66	12,7	0.50	38,1	1.50	2.38

ORS/Braze Adapter

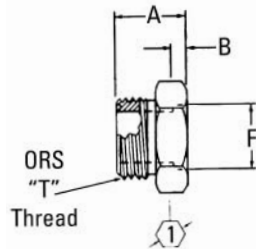

Part No. FF1851T(Size)* (Ref. SAE 520104)

Dash Size	Tube O.D.		Thread T1	A		B		F		①
	mm	in		mm	in	mm	in	mm	in	
0404S	6,4	0.25	9/16-18	19,8	0.78	6,4	0.25	6,4	0.25	0.62
0406S	6,4	0.25	9/16-18	19,8	0.78	6,4	0.25	9,7	0.38	0.62
0604S	9,7	0.38	1 ¹ /16-16	21,0	0.83	6,4	0.25	6,4	0.25	0.75
0606S	9,7	0.38	1 ¹ /16-16	21,0	0.83	6,4	0.25	9,7	0.38	0.75
0608S	9,7	0.38	1 ¹ /16-16	24,1	0.95	9,7	0.38	12,7	0.50	0.75
0806S	12,7	0.50	1 ³ /16-16	22,3	0.88	6,4	0.25	9,7	0.38	0.88
0808S	12,7	0.50	1 ³ /16-16	25,7	1.01	9,7	0.38	12,7	0.50	0.88
0810S	12,7	0.50	1 ³ /16-16	25,7	1.01	9,7	0.38	15,7	0.62	0.88
1008S	16,0	0.63	1-14	28,5	1.12	9,7	0.38	12,7	0.50	1.06
1010S	16,0	0.63	1-14	28,5	1.12	9,7	0.38	15,7	0.62	1.06
1210S	19,0	0.75	1 ³ /16-12	29,7	1.17	9,7	0.38	15,7	0.62	1.25
1212S	19,0	0.75	1 ³ /16-12	30,7	1.21	9,7	0.38	19,0	0.75	1.25
1214S	19,0	0.75	1 ³ /16-12	30,7	1.21	9,7	0.38	22,3	0.88	1.25
1216S	19,0	0.75	1 ³ /16-12	36,8	1.45	12,7	0.50	25,4	1.00	1.50
1612S	25,4	1.00	1 ⁷ /16-12	30,7	1.21	9,7	0.38	19,0	0.75	1.50
1616S	25,4	1.00	1 ⁷ /16-12	37,3	1.47	12,7	0.50	25,4	1.00	1.50
1620S	25,4	1.00	1 ⁷ /16-12	37,3	1.47	12,7	0.50	31,8	1.25	1.75
2016S	31,8	1.25	1 ¹¹ /16-12	37,3	1.47	12,7	0.50	25,4	1.00	1.75
2020S	31,8	1.25	1 ¹¹ /16-12	37,3	1.47	12,7	0.50	31,8	1.25	1.75
2024S	31,8	1.25	1 ¹¹ /16-12	37,3	1.47	12,7	0.50	38,1	1.50	2.12
2424S	38,1	1.50	2-12	37,3	1.47	12,7	0.50	38,1	1.50	2.12
2428S	38,1	1.50	2-12	40,6	1.60	15,7	0.62	44,4	1.75	2.38

*Eaton braze counterbores are dimensioned for sized or emerged tubing. If tubing is used as received, contact Eaton for appropriate part number.

**90° ORS/
Braze Port Adapter**

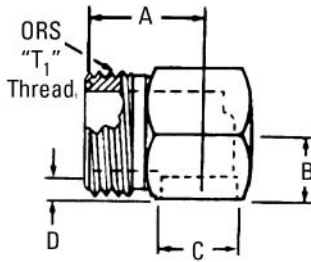

No. FF1856T(Size)* (Ref. SAE 520204)

Dash Size	Tube O.D.		Thread T1	A		B		C		D	
	mm	in		mm	in	mm	in	mm	in	mm	in
0404S	6,4	0.25	9/16-18	21,6	0.85	9,7	0.38	6,4	0.25	6,4	0.25
0606S	9,7	0.38	11/16-16	24,9	0.98	10,4	0.41	9,7	0.38	6,4	0.25
0808S	12,7	0.50	13/16-16	27,9	1.10	15,0	0.59	12,7	0.50	9,7	0.38
0810S	12,7	0.50	13/16-16	30,5	1.20	16,8	0.66	15,7	0.62	9,7	0.38
1010S	16,0	0.63	1-14	33,3	1.31	16,8	0.66	15,7	0.62	9,7	0.38
1012S	16,0	0.63	1-14	35,8	1.41	18,3	0.72	19,0	0.75	9,7	0.38
1208S	19,0	0.75	13/16-12	37,3	1.47	18,8	0.74	12,7	0.50	9,7	0.38
1212S	19,0	0.75	13/16-12	37,3	1.47	18,3	0.72	19,0	0.75	9,7	0.38
1216S	19,0	0.75	13/16-12	41,1	1.62	23,9	0.94	25,4	1.00	13,2	0.52
1616S	25,4	1.00	17/16-12	41,6	1.64	23,9	0.94	25,4	1.00	13,2	0.52
1620S	25,4	1.00	17/16-12	44,7	1.76	28,5	1.12	31,8	1.25	13,5	0.53
2016S	31,8	1.25	111/16-12	54,3	2.14	28,7	1.13	25,4	1.00	13,5	0.53
2020S	31,8	1.25	111/16-12	44,7	1.76	28,5	1.12	31,8	1.25	13,5	0.53
2424S	38,1	1.50	2-12	48,8	1.92	31,8	1.25	38,1	1.50	13,2	0.52

SPECIALTY &
TRUCK HOSE

LOW & MEDIUM
PRESSURE HOSE

HIGH PRESSURE HOSE

HOSE FITTINGS

ADAPTERS &
TUBE FITTINGS

ACCESSORIES &
ASSEMBLY INSTRUCTIONS

HOSE ASSEMBLY
EQUIPMENT

APPENDICES

**ORS/ORS/
Braze Port Adapter**

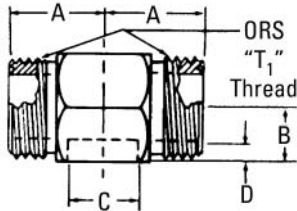

Part No. FF1858T(Size)* (Ref. SAE 520472)

Dash Size	Tube O.D.		Thread T1	A		B		C		D	
	mm	in		mm	in	mm	in	mm	in	mm	in
0404S	6,4	0.25	9/16-18	21,6	0.85	9,1	0.36	6,4	0.25	6,4	0.25
0606S	9,7	0.38	11/16-16	24,9	0.98	9,9	0.39	9,7	0.38	6,4	0.25
0608S	9,7	0.38	11/16-16	26,4	1.04	14,0	0.55	12,7	0.50	9,7	0.38
0808S	12,7	0.50	13/16-16	27,9	1.10	14,5	0.57	12,7	0.50	9,7	0.38
1010S	16,0	0.63	1-14	33,3	1.31	16,2	0.64	15,7	0.62	9,7	0.38
1212S	19,0	0.75	13/16-12	37,3	1.47	17,5	0.69	19,0	0.75	9,7	0.38
1216S	19,0	0.75	13/16-12	41,1	1.62	23,1	0.91	25,4	1.00	13,2	0.52
1616S	25,4	1.00	17/16-12	41,6	1.64	23,1	0.91	25,4	1.00	13,2	0.52
2020S	31,8	1.25	111/16-12	44,7	1.76	27,9	1.10	31,8	1.25	13,5	0.53
2424S	38,1	1.50	2-12	48,8	1.92	31,8	1.25	38,1	1.50	13,2	0.52

**ORS/Braze/
ORS Port Adapter**

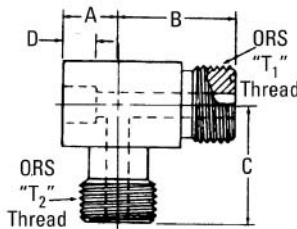

Part No. FF2115T(Size)* (Ref. SAE 520472)

Dash Size	Tube O.D.		Thread T1	Thread T2	A		B		C		D	
	mm	in			mm	in	mm	in	mm	in	mm	in
0404S	6,4	0.25	9/16-18	9/16-18	9,7	0.38	21,6	0.85	21,6	0.85	6,4	0.25
0606S	9,7	0.38	11/16-16	11/16-16	10,4	0.41	24,9	0.98	24,9	0.98	6,4	0.25
0808S	12,7	0.50	13/16-16	13/16-16	15,0	0.59	27,9	1.10	27,9	1.10	9,7	0.38
1010S	16,0	0.63	1-14	1-14	16,8	0.66	33,3	1.31	33,3	1.31	9,7	0.38
1212S	19,0	0.75	13/16-12	13/16-12	18,3	0.72	37,3	1.47	37,3	1.47	9,7	0.38
1616S	25,4	1.00	17/16-12	17/16-12	23,9	0.94	41,6	1.64	41,6	1.64	13,5	0.53
2020S	31,8	1.25	111/16-12	111/16-12	28,7	1.13	44,7	1.76	44,7	1.76	13,5	0.53
2424S	38,1	1.50	2-12	2-12	31,8	1.25	48,8	1.92	48,8	1.92	13,2	0.52

*Eaton braze counterbores are dimensioned for sized or emerged tubing. If tubing is used as received, contact Eaton for appropriate part number.

ORS-BR Nut

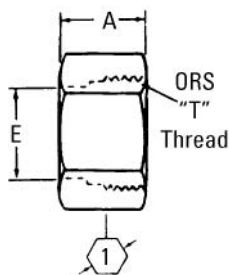

CAUTION

In applications exceeding +480°F (such as during brazing), order the oil-coated/non-plated nut by using part number FC1857-Size-186. When plating is heated above +480°F, toxic gases are given off.

ORS/O-Ring Boss

ORS/SAE O-Ring Boss Adapter

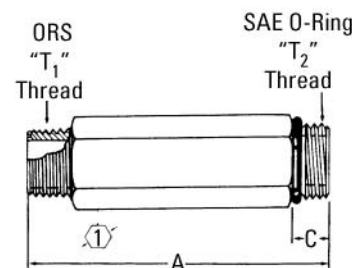

ORS/SAE O-Ring Boss Long Adapter

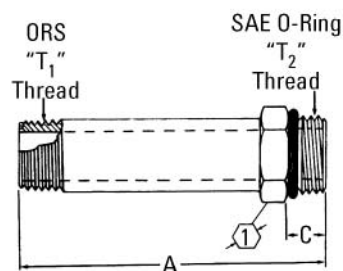

ORS Female Swivel/SAE O-Ring Boss Adapter

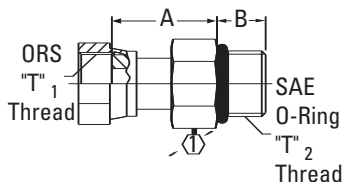

Part No. FC2326-(Size) (Ref. SAE 520110)

Dash Size	Tube O.D.		Thread T1	A		E		⌀	
	mm	in		mm	in	mm	in	mm	in
04S	6,4	0.25	9/16-18	14,7	0.58	10,4	0.41	17,5	0.69
06S	9,7	0.38	11/16-16	17,0	0.67	13,5	0.53	20,6	0.81
08S	12,7	0.50	13/16-16	21,0	0.83	16,5	0.65	23,9	0.94
10S	16,0	0.63	1-14	23,4	0.92	21,0	0.83	28,5	1.12
12S	19,0	0.75	13/16-12	25,9	1.02	24,1	0.95	35,1	1.38
14S	22,3	0.88	13/16-12	31,0	1.22	25,1	0.99	35,1	1.38
16S	25,4	1.00	17/16-12	27,9	1.10	29,0	1.14	41,1	1.62
20S	31,8	1.25	11/16-12	27,9	1.10	36,1	1.42	47,7	1.88
24S	38,1	1.50	2-12	27,9	1.10	43,9	1.73	57,2	2.25

Part No. FF2211T(Size) (Ref. SAE 520122)

Dash Size	Tube O.D.		Thread T1	Thread T2	A		C		⌀	
	mm	in			mm	in	mm	in	mm	in
0606S	9,7	0.38	11/16-16	9/16-18	50,0	1.97	11,9	0.47	19,0	0.75
0608S	9,7	0.38	11/16-16	3/4-16	54,1	2.13	14,0	0.55	22,3	0.88
0808S	12,7	0.50	13/16-16	3/4-16	68,1	2.68	14,0	0.55	22,3	0.88
1010S	16,0	0.63	1-14	7/8-14	75,9	2.99	16,0	0.63	26,9	1.06
1212S	19,0	0.75	13/16-12	11/16-12	72,9	2.87	18,5	0.73	31,8	1.25
1616S	25,4	1.00	17/16-12	15/16-12	104,5	4.11	18,5	0.73	38,1	1.50

Part No. FF1854T(Size) (Ref. SAE 520122)

Dash Size	Tube O.D.		Thread T1	Thread T2	A		C		⌀	
	mm	in			mm	in	mm	in	mm	in
0404S	6,4	0.25	9/16-18	7/16-20	52,6	2.07	10,9	0.43	15,7	0.62
0606S	9,7	0.38	11/16-16	9/16-18	57,6	2.27	11,9	0.47	19,0	0.75
0608S	9,7	0.38	11/16-16	3/4-16	66,3	2.61	14,0	0.55	22,3	0.88
0808S	12,7	0.50	13/16-16	3/4-16	67,8	2.67	14,0	0.55	22,3	0.88
1010S	16,0	0.63	1-14	7/8-14	79,5	3.13	16,0	0.63	26,9	1.06
1212S	19,0	0.75	13/16-12	11/16-12	95,2	3.75	18,5	0.73	31,8	1.25
1214S	19,0	0.75	13/16-12	13/16-12	95,2	3.75	18,5	0.73	35,1	1.38
1616S	25,4	1.00	17/16-12	15/16-12	104,9	4.13	18,5	0.73	38,1	1.50
2020S	31,8	1.25	11/16-12	15/8-12	120,6	4.75	18,5	0.73	47,7	1.88
2424S	38,1	1.50	2-12	17/8-12	133,6	5.26	18,5	0.73	53,9	2.12

Part No. FF2130T(Size) (Ref. SAE 520181)

Dash Size	Tube O.D.		Thread T1	Thread T2	A		B		⌀	
	mm	in			mm	in	mm	in	mm	in
0606S	9,7	0.38	11/16-16	9/16-18	28,2	1.11	11,9	0.47	17,5	0.69
0808S	12,7	0.50	13/16-16	3/4-16	35,3	1.39	14,0	0.55	22,3	0.88
1212S	19,0	0.75	13/16-12	11/16-12	41,1	1.62	18,5	0.73	31,8	1.25
1616S	25,4	1.00	17/16-12	15/16-12	49,0	1.93	18,5	0.73	38,1	1.50
2020S	31,8	1.25	11/16-12	15/8-12	47,2	1.86	18,5	0.73	47,7	1.88

**ORS/SAE O-Ring
Boss Adapter**

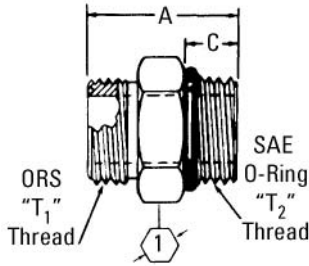

Part No. FF1852T(Size) (Ref. SAE 520120)

Dash Size	Tube O.D.		Thread T1	Thread T2	A		C		①	
	mm	in	in	in	mm	in	mm	in	mm	in
0403S	6,4	0.25	9/16-18	3/8-24	27,2	1.07	9,4	0.37	15,7	0.62
0404S	6,4	0.25	9/16-18	7/16-20	28,7	1.13	10,9	0.43	15,7	0.62
0405S	6,4	0.25	9/16-18	1/2-20	28,7	1.13	10,9	0.43	15,7	0.62
0406S	6,4	0.25	9/16-18	9/16-18	30,5	1.20	11,9	0.47	17,5	0.69
0408S	6,4	0.25	9/16-18	3/4-16	33,6	1.32	14,0	0.55	22,3	0.88
0603S	9,7	0.38	11/16-16	3/8-24	32,5	1.28	9,4	0.37	19,0	0.75
0604S	9,7	0.38	11/16-16	7/16-20	34,0	1.34	10,9	0.43	19,0	0.75
0605S	9,7	0.38	11/16-16	1/2-20	31,0	1.22	10,9	0.43	19,0	0.75
0606S	9,7	0.38	11/16-16	9/16-18	32,0	1.26	11,9	0.47	19,0	0.75
0608S	9,7	0.38	11/16-16	3/4-16	35,1	1.38	14,0	0.55	22,3	0.88
0610S	9,7	0.38	11/16-16	7/8-14	38,9	1.53	16,0	0.63	25,4	1.00
0612S	9,7	0.38	11/16-16	1 1/16-12	42,9	1.69	18,5	0.73	31,8	1.25
0616S	9,7	0.38	11/16-16	1 5/16-12	43,9	1.73	18,5	0.73	38,1	1.50
0806S	12,7	0.50	11/16-16	9/16-18	37,6	1.48	11,9	0.47	22,3	0.88
0808S	12,7	0.50	13/16-16	3/4-16	36,6	1.44	14,0	0.55	22,3	0.88
0810S	12,7	0.50	13/16-16	7/8-14	40,4	1.59	16,0	0.63	25,4	1.00
0812S	12,7	0.50	13/16-16	1 1/16-12	44,4	1.75	18,5	0.73	31,8	1.25
0814S	12,7	0.50	13/16-16	1 3/16-12	44,4	1.75	18,5	0.73	35,1	1.38
0816S	12,7	0.50	13/16-16	1 5/16-12	45,5	1.79	18,5	0.73	38,1	1.50
1008S	16,0	0.63	1-14	3/4-16	45,2	1.78	14,0	0.55	26,9	1.06
1010S	16,0	0.63	1-14	7/8-14	43,2	1.70	16,0	0.63	26,9	1.06
1012S	16,0	0.63	1-14	1 1/16-12	47,2	1.86	18,5	0.73	31,8	1.25
1014S	16,0	0.63	1-14	1 3/16-12	47,2	1.86	18,5	0.73	35,1	1.38
1206S	19,0	0.75	1 3/16-12	9/16-18	44,9	1.77	11,9	0.47	31,8	1.25
1208S	19,0	0.75	1 3/16-12	3/4-16	48,5	1.91	14,0	0.55	31,8	1.25
1210S	19,0	0.75	1 3/16-12	7/8-14	50,5	1.99	16,0	0.63	31,8	1.25
1212S	19,0	0.75	1 3/16-12	1 1/16-12	48,8	1.92	18,5	0.73	31,8	1.25
1214S	19,0	0.75	1 3/16-12	1 3/16-12	48,8	1.92	18,5	0.73	35,1	1.38
1216S	19,0	0.75	1 3/16-12	1 5/16-12	49,8	1.96	18,5	0.73	38,1	1.50
1608S	25,4	1.00	1 7/16-12	3/4-16	49,8	1.96	14,0	0.55	38,1	1.50
1610S	25,4	1.00	1 7/16-12	7/8-14	51,8	2.04	16,0	0.63	38,1	1.50
1612S	25,4	1.00	1 7/16-12	1 1/16-12	41,1	1.62	18,5	0.73	38,1	1.50
1614S	25,4	1.00	1 7/16-12	1 3/16-12	50,3	1.98	18,5	0.73	38,1	1.50
1616S	25,4	1.00	1 7/16-12	1 5/16-12	50,3	1.98	18,5	0.73	38,1	1.50
1620S	25,4	1.00	1 7/16-12	1 5/8-12	52,3	2.06	18,5	0.73	47,7	1.88
2016S	31,8	1.25	1 11/16-12	1 5/16-12	57,9	2.28	18,5	0.73	44,4	1.75
2020S	31,8	1.25	1 11/16-12	1 5/8-12	52,3	2.06	18,5	0.73	47,7	1.88
2024S	31,8	1.25	1 11/16-12	1 7/8-12	54,1	2.13	18,5	0.73	53,9	2.12
2420S	38,1	1.50	2-12	1 5/8-12	59,7	2.35	18,5	0.73	53,9	2.12
2424S	38,1	1.50	2-12	1 7/8-12	54,1	2.13	18,5	0.73	53,9	2.12

SPECIALTY &
TRUCK HOSE

LOW & MEDIUM
PRESSURE HOSE

HIGH PRESSURE HOSE

HOSE FITTINGS

ADAPTERS &
TUBE FITTINGS

ACCESSORIES &
ASSEMBLY INSTRUCTIONS

HOSE ASSEMBLY
EQUIPMENT

APPENDICIES

90° ORS/SAE O-Ring Boss (adj.) Adapter

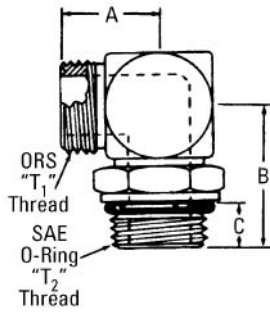

Part No. FF1868T(Size)* (Ref. SAE 520220)

Dash Size	Tube O.D.		Thread T1	Thread T2	A		B		C	
	mm	in			mm	in	mm	in	mm	in
0403S	6,4	0.25	9/16-18	3/8-24	21,6	0.85	30,3	1.19	9,4	0.37
0404S	6,4	0.25	9/16-18	7/16-20	21,6	0.85	32,8	1.29	10,9	0.43
0405S	6,4	0.25	9/16-18	1/2-20	23,4	0.92	34,8	1.37	10,9	0.43
0406S	6,4	0.25	9/16-18	9/16-18	23,4	0.92	36,8	1.45	11,9	0.47
0408S	6,4	0.25	9/16-18	3/4-16	24,6	0.97	40,6	1.60	14,0	0.55
0604S	9,7	0.38	11/16-16	7/16-20	24,9	0.98	34,8	1.37	10,9	0.43
0605S	9,7	0.38	11/16-16	1/2-20	24,9	0.98	34,8	1.37	10,9	0.43
0606S	9,7	0.38	11/16-16	9/16-18	24,9	0.98	36,8	1.45	11,9	0.47
0608S	9,7	0.38	11/16-16	3/4-16	26,4	1.04	40,6	1.60	14,0	0.55
0610S	9,7	0.38	11/16-16	7/8-14	29,2	1.15	50,0	1.97	16,0	0.63
0612S	9,7	0.38	11/16-16	1 1/16-12	31,8	1.25	55,2	2.17	18,5	0.73
0806S	12,7	0.50	13/16-16	9/16-18	27,9	1.10	36,6	1.44	11,9	0.47
0808S	12,7	0.50	13/16-16	3/4-16	27,9	1.10	40,6	1.60	14,0	0.55
0810S	12,7	0.50	13/16-16	7/8-14	30,7	1.21	50,0	1.97	16,0	0.63
0812S	12,7	0.50	13/16-16	1 1/16-12	33,6	1.32	55,2	2.17	18,5	0.73
1008S	16,0	0.63	1-14	3/4-16	33,3	1.31	45,7	1.80	14,0	0.55
1010S	16,0	0.63	1-14	7/8-14	33,3	1.31	50,0	1.97	16,0	0.63
1012S	16,0	0.63	1-14	1 1/16-12	35,8	1.41	55,2	2.17	18,5	0.73
1208S	19,0	0.75	1 3/16-12	3/4-16	37,3	1.47	46,7	1.84	14,0	0.55
1210S	19,0	0.75	1 3/16-12	7/8-14	37,3	1.47	51,1	2.01	16,0	0.63
1212S	19,0	0.75	1 3/16-12	1 1/16-12	37,3	1.47	55,2	2.17	18,5	0.73
1214S	19,0	0.75	1 3/16-12	1 3/16-12	37,3	1.47	55,2	2.17	18,0	0.71
1216S	19,0	0.75	1 3/16-12	1 5/16-12	41,1	1.62	59,7	2.35	18,5	0.73
1612S	25,4	1.00	1 7/16-12	1 1/16-12	41,6	1.64	58,9	2.32	18,5	0.73
1614S	25,4	1.00	1 7/16-12	1 3/16-12	41,6	1.64	58,9	2.32	18,0	0.71
1616S	25,4	1.00	1 7/16-12	1 5/16-12	41,6	1.64	59,7	2.35	18,5	0.73
1620S	25,4	1.00	1 7/16-12	1 5/8-12	44,7	1.76	62,2	2.45	18,5	0.73
2012S	31,8	1.25	1 11/16-12	1 1/16-12	44,7	1.76	61,5	2.42	18,5	0.73
2016S	31,8	1.25	1 11/16-12	1 5/16-12	44,7	1.76	61,5	2.42	18,5	0.73
2020S	31,8	1.25	1 11/16-12	1 5/8-12	44,7	1.76	62,2	2.45	18,5	0.73
2420S	38,1	1.50	2-12	1 5/8-12	48,8	1.92	65,0	2.56	18,5	0.73
2424S	38,1	1.50	2-12	1 7/8-12	48,8	1.92	65,8	2.59	18,5	0.73

*Available without nut, order by Part No. FF2151T(Size).

90° ORS/SAE O-Ring Boss (adj.) Long Adapter

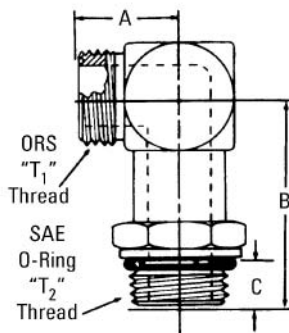

Part No. FF2227T(Size) (Ref. SAE 521520)

Dash Size	Tube O.D.		Thread T1	Thread T2	A		B		C	
	mm	in			mm	in	mm	in	mm	in
0404S	6,4	0.25	9/16-18	7/16-20	21,6	0.85	56,6	2.23	10,9	0.43
0606S	9,7	0.38	11/16-16	9/16-18	24,9	0.98	66,3	2.61	11,9	0.47
0808S	12,7	0.50	13/16-16	3/4-16	27,9	1.10	74,9	2.95	14,0	0.55
1010S	16,0	0.63	1-14	7/8-14	33,3	1.31	89,1	3.51	16,0	0.63
1212S	19,0	0.75	1 3/16-12	1 1/16-12	37,3	1.47	100,8	3.97	18,5	0.73
1616S	25,4	1.00	1 7/16-12	1 5/16-12	41,6	1.64	114,5	4.51	18,5	0.73
2020S	31,8	1.25	1 11/16-12	1 5/8-12	44,7	1.76	126,5	4.98	18,5	0.73

45° ORS/SAE O-Ring Boss (adj.) Adapter

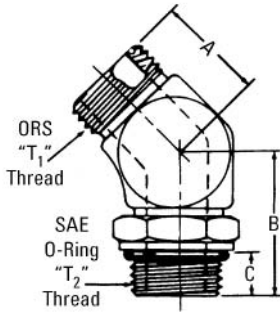

Part No. FF2068T(Size) (Ref. SAE 520320)

Dash Size	Tube O.D.		Thread T1	Thread T2	A		B		C	
	mm	in			mm	in	mm	in	mm	in
0404S	6,4	0.25	9/16-18	7/16-20	16,0	0.63	30,0	1.18	9,4	0.37
0406S	6,4	0.25	9/16-18	9/16-18	17,3	0.68	33,0	1.30	11,9	0.47
0408S	6,4	0.25	9/16-18	3/4-16	17,0	0.67	36,3	1.43	14,0	0.55
0604S	9,7	0.38	11/16-16	7/16-20	18,8	0.74	31,0	1.22	10,9	0.43
0606S	9,7	0.38	11/16-16	9/16-18	18,8	0.74	33,0	1.30	11,9	0.47
0608S	9,7	0.38	11/16-16	3/4-16	18,8	0.74	36,3	1.43	14,0	0.55
0806S	12,7	0.50	13/16-16	9/16-18	20,3	0.80	32,8	1.29	11,9	0.47
0808S	12,7	0.50	13/16-16	3/4-16	20,3	0.80	36,3	1.43	14,0	0.55
0810S	12,7	0.50	13/16-16	7/8-14	20,8	0.82	44,7	1.76	16,0	0.63
0816S	12,7	0.50	13/16-16	15/16-12	25,7	1.01	52,3	2.06	18,5	0.73
1008S	16,0	0.63	1-14	3/4-16	23,4	0.92	40,4	1.59	12,7	0.50
1010S	16,0	0.63	1-14	7/8-14	23,4	0.92	44,7	1.76	16,0	0.63
1012S	16,0	0.63	1-14	11/16-12	24,4	0.96	50,0	1.97	18,5	0.73
1210S	19,0	0.75	13/16-12	7/8-14	25,9	1.02	46,0	1.81	16,0	0.63
1212S	19,0	0.75	13/16-12	11/16-12	25,9	1.02	50,0	1.97	18,5	0.73
1216S	19,0	0.75	13/16-12	15/16-12	29,5	1.16	52,3	2.06	18,5	0.73
1612S	25,4	1.00	17/16-12	11/16-12	30,0	1.18	51,6	2.03	18,5	0.73
1616S	25,4	1.00	17/16-12	15/16-12	30,0	1.18	52,3	2.06	18,5	0.73
1620S	25,4	1.00	17/16-12	15/8-12	32,0	1.26	53,6	2.11	18,5	0.73
2020S	31,8	1.25	111/16-12	15/8-12	32,0	1.26	53,6	2.11	18,5	0.73
2424S	38,1	1.50	2-12	17/8-12	36,8	1.45	53,6	2.11	18,5	0.73

ORS - SAE O-Ring Branch Cross (6000 psi)

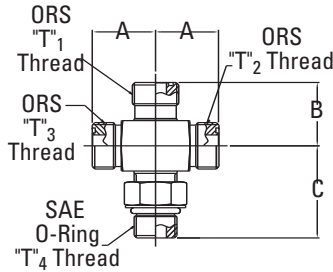

Part No. FF2127T(Size) (Ref. SAE 520520)

Dash Size	Tube O.D.		Thread T1	Thread T2	Thread T3	Thread T4	A		B		C	
	mm	in					mm	in	mm	in	mm	in
0606S	9,7	0.38	11/16-16	11/16-16	11/16-16	9/16-18	24,9	0.98	24,6	0.97	36,6	1.44
0808S	12,7	0.50	13/16-16	13/16-16	13/16-16	3/4-16	27,9	1.10	27,7	1.09	40,4	1.59

ORS/ORS/SAE O-Ring Boss (Adj) Adapter

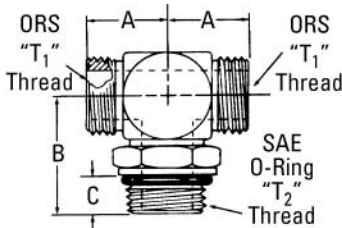

Part No. FF1861T(Size) (Ref. SAE 520429)

Dash Size	Tube O.D.		Thread T1	Thread T2	A		B		C	
	mm	in			mm	in	mm	in	mm	in
0403S	6,4	0.25	9/16-18	3/8-24	21,6	0.85	30,3	1.19	9,4	0.37
0404S	6,4	0.25	9/16-18	7/16-20	21,6	0.85	32,8	1.29	10,9	0.43
0606S	9,7	0.38	11/16-16	9/16-18	24,9	0.98	36,8	1.45	11,9	0.47
0608S	9,7	0.38	11/16-16	3/4-16	26,4	1.04	40,6	1.60	14,0	0.55
0808S	12,7	0.50	13/16-16	3/4-16	33,3	1.31	50,0	1.97	14,0	0.55
1010S	16,0	0.63	1-14	7/8-14	33,3	1.31	50,0	1.97	16,0	0.63
1210S	19,0	0.75	13/16-12	7/8-14	37,3	1.47	55,2	2.17	16,0	0.63
1212S	19,0	0.75	13/16-12	15/16-12	41,1	1.62	59,7	2.35	18,5	0.73
1216S	19,0	0.75	13/16-12	15/16-12	41,6	1.64	59,7	2.35	18,5	0.73
1616S	25,4	1.00	17/16-12	15/16-12	41,6	1.64	59,7	2.35	18,5	0.73
2020S	31,8	1.25	111/16-12	15/8-12	44,7	1.76	62,2	2.45	18,5	0.73
2424S	38,1	1.50	2-12	17/8-12	48,8	1.92	65,8	2.59	18,5	0.73

SPECIALTY & TRUCK HOSE
 LOW & MEDIUM PRESSURE HOSE
 HIGH PRESSURE HOSE
 HOSE FITTINGS
 ADAPTERS & TUBE FITTINGS
 ACCESSORIES & ASSEMBLY INSTRUCTIONS
 HOSE ASSEMBLY EQUIPMENT
 APPENDICES

ORS/ORS/SAE O-Ring Boss (Adj) Adapter

Part No. FF1865(Size) (Ref. SAE 520429)

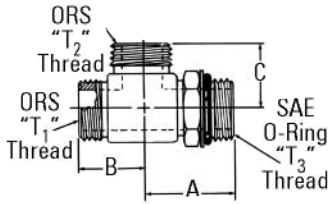

Dash Size	Tube O.D.		Thread T1	Thread T2	Thread T3	A		B		C	
	mm	in				mm	in	mm	in	mm	in
0404S	6,4	0.25	9/16-18	9/16-18	7/16-20	32,8	1.29	21,6	0.85	21,6	0.85
0406S	6,4	0.25	9/16-18	9/16-18	9/16-18	36,8	1.45	23,4	0.92	23,4	0.92
0604S	9,7	0.38	11/16-16	11/16-16	7/16-20	34,8	1.37	29,7	1.17	24,9	0.98
0606S	9,7	0.38	11/16-16	11/16-16	9/16-18	36,8	1.45	24,9	0.98	24,9	0.98
0806S	12,7	0.50	13/16-16	13/16-16	9/16-18	36,6	1.44	27,9	1.10	27,9	1.10
0808S	12,7	0.50	13/16-16	13/16-16	3/4-16	40,6	1.60	27,9	1.10	27,9	1.10
0812S	12,7	0.50	13/16-16	13/16-16	1 1/16-12	55,2	2.17	33,6	1.32	33,6	1.32
1010S	16,0	0.63	1-14	1-14	7/8-14	50,0	1.97	33,3	1.31	33,3	1.31
1012S	16,0	0.63	1-14	1-14	1 1/16-12	55,2	2.17	35,8	1.41	35,8	1.41
1212S	19,0	0.75	1 3/16-12	1 3/16-12	1 1/16-12	55,2	2.17	37,3	1.47	37,3	1.47
1220S	19,0	0.75	1 3/16-12	1 3/16-12	1 5/8-12	62,2	2.45	44,2	1.74	44,2	1.74
1616S	25,4	1.00	1 7/16-12	1 7/16-12	1 5/16-12	59,7	2.35	41,6	1.64	41,6	1.64
2020S	31,8	1.25	1 11/16-12	1 11/16-12	1 5/8-12	62,2	2.45	44,7	1.76	44,7	1.76
2424S	38,1	1.50	2-12	2-12	1 7/8-12	65,8	2.59	48,8	1.92	48,8	1.92
0005S	-		1 7/16-12	1 3/16-12	1 1/16-12	58,9	2.32	41,6	1.64	41,1	1.62
0001S	-		1 7/16-12	1 3/16-12	1 5/16-12	59,7	2.35	41,6	1.64	41,1	1.62
0012S	-		1 3/16-16	1 11/16-12	1 5/16-12	61,5	2.42	40,4	1.59	44,7	1.76
0003S	-		1-14	1 3/16-16	1 1/16-12	55,2	2.17	35,8	1.41	33,6	1.32

ORS/NPTF

ORS/Male NPTF Adapter

Part No. FF2031T(Size) (Ref. SAE 520102)

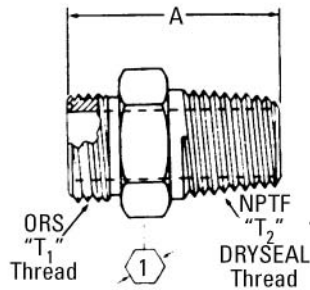

Dash Size	Tube O.D.		Thread T1	Thread T2	A		①	
	mm	in			mm	in	mm	in
0402S	6,4	0.25	9/16-18	1/8-27	26,2	1.03	15,7	0.62
0404S	6,4	0.25	9/16-18	1/4-18	31,5	1.24	15,7	0.62
0406S	6,4	0.25	9/16-18	3/8-18	31,5	1.24	19,0	0.75
0408S	6,4	0.25	9/16-18	1/2-14	37,8	1.49	22,3	0.88
0602S	9,7	0.38	11/16-16	1/8-27	28,5	1.12	19,0	0.75
0604S	9,7	0.38	11/16-16	1/4-18	33,0	1.30	19,0	0.75
0606S	9,7	0.38	11/16-16	3/8-18	33,0	1.30	19,0	0.75
0608S	9,7	0.38	11/16-16	1/2-14	39,4	1.55	22,3	0.88
0804S	12,7	0.50	13/16-16	1/4-18	34,5	1.36	22,3	0.88
0806S	12,7	0.50	13/16-16	3/8-18	34,5	1.36	22,3	0.88
0808S	12,7	0.50	13/16-16	1/2-14	40,9	1.61	22,3	0.88
0812S	12,7	0.50	13/16-16	3/4-14	42,7	1.68	26,9	1.06
1008S	16,0	0.63	1-14	1/2-14	43,7	1.72	26,9	1.06
1012S	16,0	0.63	1-14	3/4-14	45,2	1.78	26,9	1.06
1016S	16,0	0.63	1-14	1-11 1/2	50,0	1.97	35,1	1.38
1208S	19,0	0.75	1 3/16-12	1/2-14	46,7	1.84	31,8	1.25
1212S	19,0	0.75	1 3/16-12	3/4-14	46,7	1.84	31,8	1.25
1216S	19,0	0.75	1 3/16-12	1-11 1/2	51,6	2.03	35,1	1.38
1612S	25,4	1.00	1 7/16-12	3/4-14	47,2	1.86	38,1	1.50
1616S	25,4	1.00	1 7/16-12	1-11 1/2	52,0	2.05	38,1	1.50
1620S	25,4	1.00	1 7/16-12	1 1/4-11 1/2	54,9	2.16	42,9	1.69
2016S	31,8	1.25	1 11/16-12	1-11 1/2	54,1	2.13	44,4	1.75
2020S	31,8	1.25	1 11/16-12	1 1/4-11 1/2	54,9	2.16	44,4	1.75
2424S	38,1	1.50	2-12	1 1/2-11 1/2	57,4	2.26	53,9	2.12

**45° ORS/Male
NPTF Adapter**

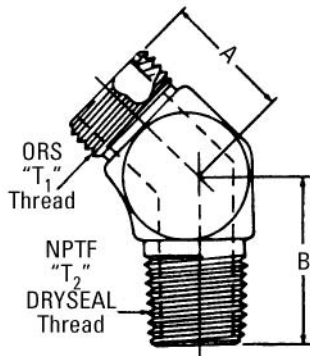

Part No. FF2093T(Size) (Ref. SAE 520302)

Dash Size	Tube O.D.		Thread T1	Thread T2	A		B	
	mm	in			mm	in	mm	in
0402S	6,4	0.25	9/16-18	1/8-27	16,0	0.63	17,3	0.68
0404S	6,4	0.25	9/16-18	1/4-18	17,3	0.68	23,6	0.93
0406S	6,4	0.25	9/16-18	3/8-18	17,0	0.67	26,4	1.04
0604S	9,7	0.38	11/16-16	1/4-18	18,8	0.74	23,6	0.93
0606S	9,7	0.38	11/16-16	3/8-18	18,8	0.74	26,4	1.04
0608S	9,7	0.38	11/16-16	1/2-14	19,3	0.76	30,7	1.21
0804S	12,7	0.50	13/16-16	1/4-18	20,3	0.80	23,4	0.92
0806S	12,7	0.50	13/16-16	3/8-18	20,3	0.80	26,4	1.04
0808S	12,7	0.50	13/16-16	1/2-14	20,8	0.82	30,5	1.20
1008S	16,0	0.63	1-14	1/2-14	23,4	0.92	30,5	1.20
1212S	19,0	0.75	13/16-12	3/4-14	25,9	1.02	31,2	1.23
1616S	25,4	1.00	17/16-12	1-11 1/2	30,0	1.18	38,3	1.51
2020S	31,8	1.25	111/16-12	11/4-11 1/2	32,0	1.26	42,9	1.69
2424S	38,1	1.50	2-12	11/2-11 1/2	36,8	1.45	45,7	1.80

SPECIALTY &
TRUCK HOSE

LOW & MEDIUM
PRESSURE HOSE

HIGH PRESSURE HOSE

HOSE FITTINGS

ADAPTERS &
TUBE FITTINGS

ACCESSORIES &
ASSEMBLY INSTRUCTIONS

HOSE ASSEMBLY
EQUIPMENT

APPENDICES

**90° ORS/Male
NPTF Adapter**

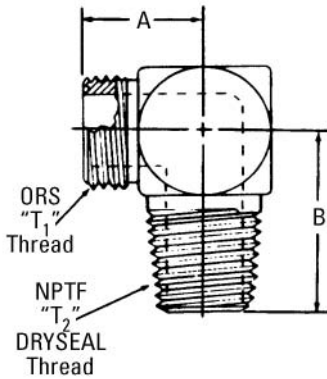

Part No. FF2032T(Size) (Ref. SAE 520202)

Dash Size	Tube O.D.		Thread T1	Thread T2	A		B	
	mm	in			mm	in	mm	in
0402S	6,4	0.25	9/16-18	1/8-27	21,6	0.85	19,8	0.78
0404S	6,4	0.25	9/16-18	1/4-18	23,4	0.92	27,4	1.08
0602S	9,7	0.38	11/16-16	1/8-27	24,9	0.98	21,8	0.86
0604S	9,7	0.38	11/16-16	1/4-18	24,9	0.98	27,4	1.08
0606S	9,7	0.38	11/16-16	3/8-18	26,4	1.04	30,7	1.21
0608S	9,7	0.38	11/16-16	1/2-14	29,2	1.15	38,9	1.53
0802S	12,7	0.50	13/16-16	1/8-27	27,9	1.10	26,9	1.06
0806S	12,7	0.50	13/16-16	3/8-18	27,9	1.10	30,7	1.21
0808S	12,7	0.50	13/16-16	1/2-14	30,7	1.21	38,9	1.53
0812S	12,7	0.50	13/16-14	3/4-14	33,6	1.32	41,9	1.65
1008S	16,0	0.63	1-14	1/2-14	33,3	1.31	38,9	1.53
1012S	16,0	0.63	1-14	3/4-14	35,8	1.41	41,9	1.65
1208S	19,0	0.75	13/16-12	1/2-14	37,3	1.47	41,9	1.65
1212S	19,0	0.75	13/16-12	3/4-14	37,3	1.47	41,9	1.65
1216S	19,0	0.75	13/16-12	1-11 1/2	41,1	1.62	51,6	2.03
1612S	25,4	1.00	17/16-12	3/4-14	41,6	1.64	46,7	1.84
1616S	25,4	1.00	17/16-12	1-11 1/2	41,6	1.64	51,6	2.03
2016S	31,8	1.25	111/16-12	1-11 1/2	44,7	1.76	60,4	2.38
2020S	31,8	1.25	111/16-12	11/4-11 1/2	44,7	1.76	61,2	2.41
2424S	38,1	1.50	2-12	11/2-11 1/2	48,8	1.92	68,6	2.70

**ORS/ORS/
Male NPTF Adapter**

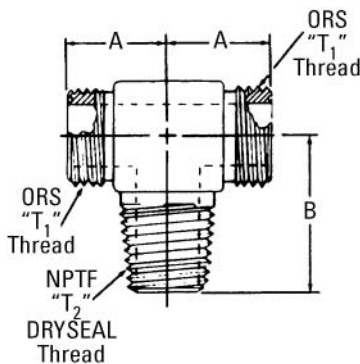

Part No. FF2001T(Size) (Ref. SAE 520425)

Dash Size	Tube O.D.		Thread T1	Thread T2	A		B	
	mm	in			mm	in	mm	in
0402S	6,4	0.25	9/16-18	1/8-27	21,6	0.85	19,8	0.78
0404S	6,4	0.25	9/16-18	1/4-18	23,4	0.92	27,4	1.08
0604S	9,7	0.38	11/16-16	1/4-18	24,9	0.98	27,4	1.08
0606S	9,7	0.38	11/16-16	3/8-18	26,4	1.04	30,7	1.21
0806S	12,7	0.50	13/16-16	3/8-18	27,9	1.10	30,7	1.21
0808S	12,7	0.50	13/16-16	1/2-14	30,7	1.21	38,9	1.53
1008S	16,0	0.63	1-14	1/2-14	33,3	1.31	38,9	1.53
1206S	19,0	0.75	13/16-12	1/2-18	37,3	1.47	37,1	1.46
1212S	19,0	0.75	13/16-12	3/4-14	37,3	1.47	41,9	1.65
1216S	19,0	0.75	13/16-12	1-11 1/2	41,4	1.63	51,6	2.03
1616S	25,4	1.00	17/16-12	1-11 1/2	41,6	1.64	51,6	2.03
2020S	31,8	1.25	111/16-12	11/4-11 1/2	44,7	1.76	61,2	2.41
2424S	38,1	1.50	2-12	11/2-11 1/2	48,8	1.92	68,6	2.70

ORS to SAE 37° Flare

ORS Female Swivel/SAE 37° Male Flare

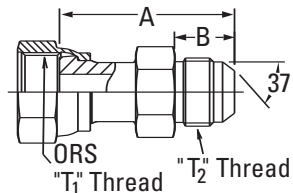

Part No. FF2209T(Size)

Dash Size	Tube O.D.		Thread T1	Thread T2	A		B	
	mm	in			mm	in	mm	in
0412S	6,4	0.25	9/16-18	1 1/16-12	50,5	1.99	21,8	0.86
0612S	9,7	0.38	1 1/16-16	1 1/16-12	52,6	2.07	21,8	0.86
0808S	12,7	0.50	1 3/16-16	3/4-16	51,6	2.03	16,8	0.66
0812S	12,7	0.50	1 3/16-16	1 1/16-12	57,2	2.25	21,8	0.86
1212S	19,0	0.75	1 3/16-12	1 1/16-12	62,0	2.44	21,8	0.86
1616S	25,4	1.00	1 7/16-12	1 5/16-12	71,6	2.82	23,1	0.91
2016S	31,8	1.25	1 11/16-12	1 5/16-12	73,1	2.88	23,1	0.91

Male ORS/SAE 37° Male Flare

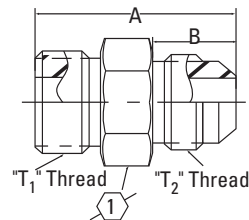

Part No. FF2313T(Dash Size)

Dash Size	Tube O.D.		Thread T1	Thread T2	A		B		①	
	mm	in			mm	in	mm	in	mm	in
0808S	12,7	0.50	3/16-16	3/4-16	39,1	1.54	16,8	0.66	22,3	0.88
1010S	16,0	0.63	1-14	7/8-14	46,5	1.83	19,3	0.76	26,9	1.06
1212S	19,0	0.75	1 3/16-12	1 1/10-16	52,1	2.05	21,8	0.86	31,8	1.25

ORS/ORS ORS/ORS Adapter

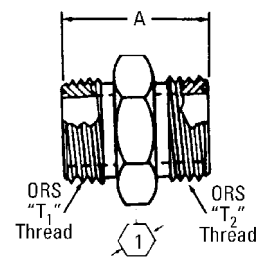

Part No. FF2000T(Size) (Ref. SAE 520101)

Dash Size	Tube O.D.		Thread T1	Thread T2	A		①	
	mm	in			mm	in	mm	in
0404S	6,4	0.25	9/16-18	9/16-18	27,4	1.08	15,7	0.62
0604S	9,7	0.38	1 1/16-16	9/16-18	29,7	1.17	19,0	0.75
0606S	9,7	0.38	1 1/16-16	1 1/16-16	31,0	1.22	19,0	0.75
0806S	12,7	0.50	1 3/16-16	1 1/16-16	33,8	1.33	22,3	0.88
0808S	12,7	0.50	1 3/16-16	1 3/16-16	35,3	1.39	22,3	0.88
1008S	16,0	0.63	1-14	1 3/16-16	39,9	1.57	26,9	1.06
1010S	16,0	0.63	1-14	1-14	42,7	1.68	26,9	1.06
1208S	19,0	0.75	1 3/16-12	1 3/16-16	42,9	1.69	31,8	1.25
1210S	19,0	0.75	1 3/16-12	1-14	45,7	1.80	31,8	1.25
1212S	19,0	0.75	1 3/16-12	1 3/16-12	47,2	1.86	31,8	1.25
1612S	25,4	1.00	1 7/16-12	1 3/16-12	48,8	1.92	38,1	1.50
1616S	25,4	1.00	1 7/16-12	1 7/16-12	49,3	1.94	38,1	1.50
2020S	31,8	1.25	1 11/16-12	1 11/16-12	51,3	2.02	44,4	1.75
2424S	38,1	1.50	2-12	2-12	53,1	2.09	53,9	2.12

ORS/ORS Reducer Adapter

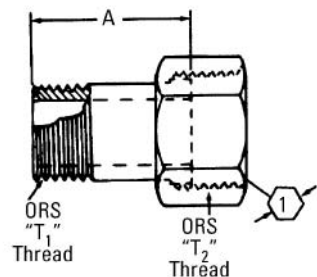

Part No. FF2281T(Size) (Ref. SAE 520123)

Dash Size	Tube O.D.		Thread T1	Thread T2	A		①	
	mm	in			mm	in	mm	in
0406S	9,7	0.38	9/16-18	1 1/16-16	19,5	0.77	20,6	0.81
0408S†	12,7	0.50	9/16-18	1 3/16-16	21,8	0.86	23,9	0.94
0410S†	16,0	0.63	9/16-18	1-14	22,9	0.90	28,5	1.12
0412S†	19,0	0.75	9/16-18	1 3/16-12	24,9	0.98	35,1	1.38
0608S	12,7	0.50	1 1/16-16	1 3/16-16	22,3	0.88	23,9	0.94
0610S†	16,0	0.63	1 1/16-16	1-14	24,1	0.95	28,5	1.12
0612S†	19,0	0.75	1 1/16-16	1 3/16-12	26,2	1.03	35,1	1.38
0810S†	16,0	0.63	1 3/16-16	1-14	25,9	1.02	28,5	1.12
0812S†	19,0	0.75	1 3/16-16	1 3/16-12	27,9	1.10	35,1	1.38
0816S†	25,4	1.00	1 3/16-16	1 7/16-12	29,2	1.15	41,1	1.62
1012S	19,0	0.75	1-14	1 3/16-12	29,5	1.16	35,1	1.38
1216S	25,4	1.00	1 3/16-12	1 7/16-12	34,0	1.34	41,1	1.62
1220S†	31,8	1.25	1 3/16-12	1 11/16-12	33,5	1.32	47,7	1.88
1224S†	38,1	1.50	1 3/16-12	2-12	33,6	1.32	57,2	2.25
1620S	31,8	1.25	1 7/16-12	1 11/16-12	37,3	1.47	47,7	1.88
1624S†	38,1	1.50	1 7/16-12	2-12	34,0	1.34	57,2	2.25

† Available without nut. Order by part number FF2151T(Size).

**ORS/ORS
Bulkhead Adapter**

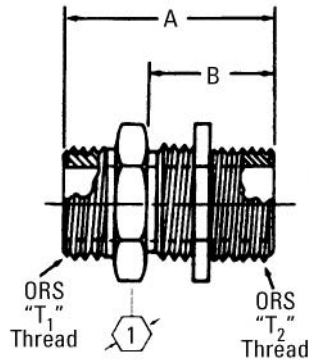

Part No. FF194T(Size) (Ref. SAE 520601)

Dash Size	Tube O.D.		Thread T1	Thread T2	A		B		Ø	
	mm	in			mm	in	mm	in	mm	in
0404S	6,4	0.25	9/16-18	9/16-18	48,3	1.90	31,5	1.24	20,6	0.81
0606S	9,7	0.38	11/16-16	11/16-16	53,1	2.09	34,0	1.34	25,4	1.00
0608S	9,7	0.38	11/16-16	13/16-16	56,9	2.24	36,6	1.44	28,5	1.12
0808S	12,7	0.50	13/16-16	13/16-16	58,4	2.30	36,6	1.44	28,5	1.12
1008S	16,0	0.63	1-14	13/16-16	62,5	2.46	36,6	1.44	28,5	1.12
1010S	16,0	0.63	1-14	1-14	66,5	2.62	40,6	1.60	33,3	1.31
1212S	19,0	0.75	13/16-12	13/16-12	69,1	2.72	41,6	1.64	38,1	1.50
1616S	25,4	1.00	17/16-12	17/16-12	70,1	2.76	42,2	1.66	44,4	1.75
2016S	31,8	1.25	111/16-12	17/16-12	70,1	2.76	42,2	1.66	44,4	1.75
2020S	31,8	1.25	111/16-12	111/16-12	70,1	2.76	42,2	1.66	50,8	2.00
2424S	38,1	1.50	2-12	2-12	70,1	2.76	42,2	1.66	60,4	2.38

**45° ORS/ORS
Female Adapter**

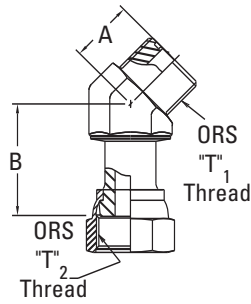

Part No. FF2133T(Size)

Dash Size	Tube O.D.		Thread T1	Thread T2	A		B	
	mm	in			mm	in	mm	in
0606S	9,7	0.38	11/16-16	11/16-16	18,8	0.74	26,9	1.06
0808S	12,7	0.50	13/16-16	13/16-16	20,3	0.80	35,6	1.40
1010S	16,0	0.63	1-14	1-14	23,4	0.92	38,6	1.52
1212S	19,0	0.75	13/16-12	13/16-12	25,9	1.02	42,4	1.67

**45° ORS/ORS
Bulkhead Adapter**

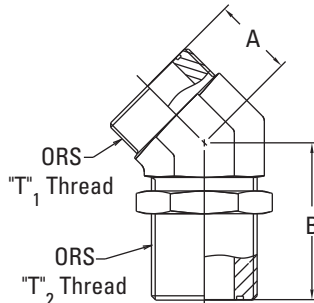

Part No. FF2144T(Size) (Ref. SAE 520801)

Dash Size	Tube O.D.		Thread T1	Thread T2	A		B	
	mm	in			mm	in	mm	in
0404S	6,4	0.25	9/16-18	9/16-18	16,0	0.63	43,9	1.73
0606S	9,7	0.38	11/16-16	11/16-16	18,8	0.74	48,5	1.91
0808S	12,7	0.50	13/16-16	13/16-16	20,3	0.80	51,1	2.01
1010S	16,0	0.63	1-14	1-14	23,4	0.92	56,6	2.23
1212S	19,0	0.75	13/16-12	13/16-12	25,9	1.02	60,7	2.39
1616S	25,4	1.00	17/16-12	17/16-12	30,0	1.18	65,3	2.57
2020S	31,8	1.25	111/16-12	111/16-12	32,0	1.26	67,0	2.64
2424S	38,1	1.50	2-12	2-12	36,8	1.45	67,0	2.64

**90° ORS/ORS
Female Adapter**

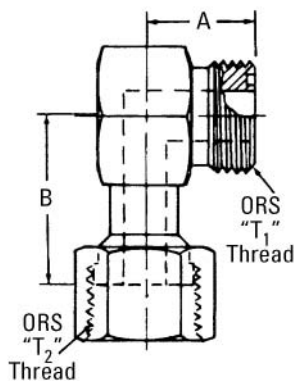

Part No. FF2098T(Size) (Ref. SAE 520221)

Dash Size	Tube O.D.		Thread T1	Thread T2	A		B	
	mm	in			mm	in	mm	in
0404S	6,4	0.25	9/16-18	9/16-18	21,6	0.85	26,4	1.04
0606S	9,7	0.38	11/16-16	11/16-16	24,9	0.98	29,2	1.15
0808S	12,7	0.50	13/16-16	13/16-16	27,9	1.10	37,8	1.49
1010S	16,0	0.63	1-14	1-14	33,3	1.31	41,1	1.62
1212S	19,0	0.75	13/16-12	13/16-12	37,3	1.47	46,2	1.82
1616S	25,4	1.00	17/16-12	17/16-12	41,6	1.64	53,3	2.10
2020S	31,8	1.25	111/16-12	111/16-12	44,7	1.76	58,2	2.29
2424S	38,1	1.50	2-12	2-12	48,8	1.92	61,2	2.41

90° ORS/ORS Adapter

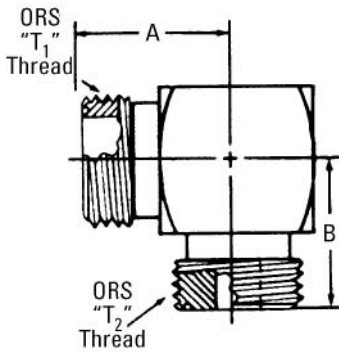

Part No. FF2035T(Size) (Ref. SAE 520201)

Dash Size	Tube O.D.		Thread T1	Thread T2	A		B	
	mm	in			mm	in	mm	in
0404S	6,4	0.25	9/16-18	9/16-18	21,6	0.85	21,6	0.85
0604S	9,7	0.38	11/16-16	9/16-18	24,9	0.98	23,4	0.92
0606S	9,7	0.38	11/16-16	11/16-16	24,9	0.98	24,9	0.98
0804S	12,7	0.50	13/16-16	9/16-18	27,9	1.10	24,6	0.97
0806S	12,7	0.50	13/16-16	11/16-16	27,9	1.10	26,4	1.04
0808S	12,7	0.50	13/16-16	13/16-16	27,9	1.10	27,9	1.10
1010S	16,0	0.63	1-14	1-14	33,3	1.31	33,3	1.31
1208S	19,0	0.75	13/16-12	13/16-16	37,3	1.47	34,0	1.34
1212S	19,0	0.75	13/16-12	13/16-12	37,3	1.47	37,3	1.47
1616S	25,4	1.00	17/16-12	17/16-12	41,6	1.64	41,6	1.64
2020S	31,8	1.25	11/16-12	11/16-12	44,7	1.76	44,7	1.76
2424S	38,1	1.50	2-12	2-12	48,8	1.92	48,8	1.92

90° ORS/ORS Bulkhead Adapter

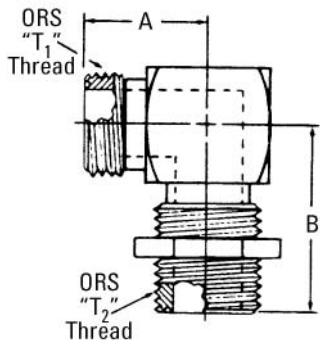

Part No. FF2030T(Size) (Ref. SAE 520701)

Dash Size	Tube O.D.		Thread T1	Thread T2	A		B		E	
	mm	in			mm	in	mm	in	mm	in
0404S	6,4	0.25	9/16-18	9/16-18	22,6	0.89	47,0	1.85	4,3	0.17
0606S	9,7	0.38	11/16-16	11/16-16	25,9	1.02	52,0	2.05	6,6	0.26
0806S	12,7	0.50	13/16-16	11/16-16	29,0	1.14	53,9	2.12	6,6	0.26
0808S	12,7	0.50	13/16-16	13/16-16	29,0	1.14	55,4	2.18	9,7	0.38
1010S	16,0	0.63	1-14	1-14	34,5	1.36	63,0	2.48	12,2	0.48
1212S	19,0	0.75	13/16-12	13/16-12	38,6	1.52	67,3	2.65	15,5	0.61
1616S	25,4	1.00	17/16-12	17/16-12	42,4	1.67	71,1	2.80	20,6	0.81
2020S	31,8	1.25	11/16-12	11/16-12	45,5	1.79	75,4	2.97	26,2	1.03
2424S	38,1	1.50	2-12	2-12	49,5	1.95	79,5	3.13	32,0	1.26

ORS/ORS/ORS

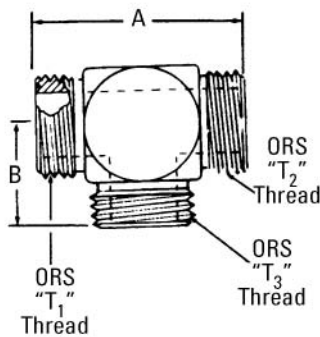

Part No. FF1898T(Size) (Ref. SAE 520401)

Dash Size	Tube O.D.		Thread T1	Thread T2	Thread T3	A		B	
	mm	in				mm	in	mm	in
0404S	6,4	0.25	9/16-18	9/16-18	9/16-18	43,2	1.70	21,6	0.85
0606S	9,7	0.38	11/16-16	11/16-16	11/16-16	49,8	1.96	24,9	0.98
0608S	9,7	0.38	11/16-16	11/16-16	13/16-16	52,8	2.08	27,9	1.10
0808S	12,7	0.50	13/16-16	13/16-16	13/16-16	55,9	2.20	27,9	1.10
1010S	16,0	0.63	1-14	1-14	1-14	66,5	2.62	33,3	1.31
0004S			13/16-12	13/16-16	13/16-16	70,9	2.79	33,6	1.32
1212S	19,0	0.75	13/16-12	13/16-12	13/16-12	74,7	2.94	37,3	1.47
1216S	19,0	0.75	13/16-12	13/16-12	17/16-12	82,3	3.24	44,7	1.76
1616S	25,4	1.00	17/16-12	17/16-12	17/16-12	83,3	3.28	41,6	1.64
0003S			11/16-12	17/16-12	13/16-12	89,4	3.52	44,2	1.74
2016S	31,8	1.25	11/16-12	11/16-12	17/16-12	89,4	3.52	44,7	1.76
2020S	31,8	1.25	11/16-12	11/16-12	11/16-12	89,4	3.52	44,7	1.76
2424S	38,1	1.50	2-12	2-12	2-12	97,5	3.84	48,8	1.92

ORS - Bulkhead Run Tee

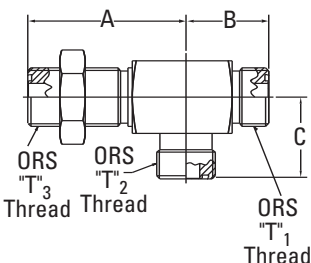

Part No. FF2174T(Size) (Ref. SAE 520958)

Dash Size	Tube O.D.		Thread T1	Thread T2	Thread T3	A		B		C	
	mm	in				mm	in	mm	in	mm	in
0404S	6,4	0.25	9/16-18	9/16-18	9/16-18	47,0	1.85	22,6	0.89	22,6	0.89
0606S	9,7	0.38	11/16-16	11/16-16	11/16-16	52,0	2.05	25,9	1.02	25,7	1.01
0808S	12,7	0.50	13/16-16	13/16-16	13/16-16	55,4	2.18	29,0	1.14	28,7	1.13
1212S	19,0	0.75	13/16-12	13/16-12	13/16-12	54,9	2.16	40,6	1.60	40,6	1.60
1616S	25,4	1.00	17/16-12	17/16-12	17/16-12	71,1	2.80	42,4	1.67	42,4	1.67

SPECIALTY & TRUCK HOSE
 LOW & MEDIUM PRESSURE HOSE
 HIGH PRESSURE HOSE
 HOSE FITTINGS
 ADAPTERS & TUBE FITTINGS
 ACCESSORIES & ASSEMBLY INSTRUCTIONS
 HOSE ASSEMBLY EQUIPMENT
 APPENDICES

**ORS/ORS/ORS
Female Adapter**

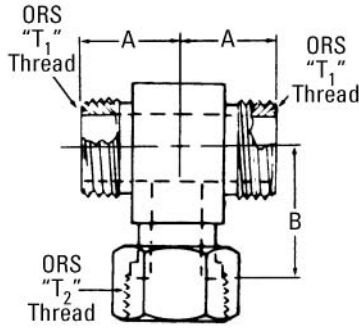

Part No. FF1857T(Size) (Ref. SAE 520433)

Dash Size	Tube O.D.		Thread T1	Thread T2	A		B	
	mm	in			mm	in	mm	in
0404S	6,4	0.25	9/16-18	9/16-18	21,6	0.85	26,4	1.04
0606S	9,7	0.38	11/16-16	11/16-16	24,9	0.98	29,2	1.15
0808S	12,7	0.50	13/16-16	13/16-16	27,9	1.10	37,8	1.49
1010S	16,0	0.63	1-14	1-14	33,3	1.31	41,1	1.62
1212S	19,0	0.75	13/16-12	13/16-12	37,3	1.47	46,2	1.82
1616S	25,4	1.00	17/16-12	17/16-12	41,6	1.64	53,3	2.10
2020S	31,8	1.25	111/16-12	111/16-12	44,7	1.76	58,2	2.29
2424S	38,1	1.50	2-12	2-12	48,8	1.92	61,2	2.41

**ORS/ORS Female/
ORS Adapter**

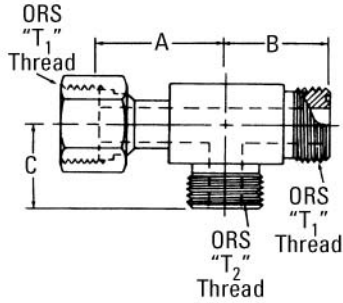

Part No. FF2114T(Size) (Ref. SAE 520432)

Dash Size	Tube O.D.		Thread T1	Thread T2	A		B		C	
	mm	in			mm	in	mm	in	mm	in
0404S	6,4	0.25	9/16-18	9/16-18	26,4	1.04	21,6	0.85	21,6	0.85
0606S	9,7	0.38	11/16-16	11/16-16	29,2	1.15	24,9	0.98	24,9	0.98
0808S	12,7	0.50	13/16-16	13/16-16	37,8	1.49	27,9	1.10	27,9	1.10
1010S	16,0	0.63	1-14	1-14	41,1	1.62	33,3	1.31	33,3	1.31
0001S	-	-	13/16-12	9/16-18	46,2	1.82	37,3	1.47	30,3	1.19
1212S	19,0	0.75	13/16-12	13/16-12	46,2	1.82	37,3	1.47	37,3	1.47
1616S	25,4	1.00	17/16-12	17/16-12	53,3	2.10	41,6	1.64	41,6	1.64
2020S	31,8	1.25	111/16-12	111/16-12	58,2	2.29	44,7	1.76	44,7	1.76
2424S	38,1	1.50	2-12	2-12	61,2	2.41	48,8	1.92	48,8	1.92

**ORS/ORS/ORS
Bulkhead Adapter**

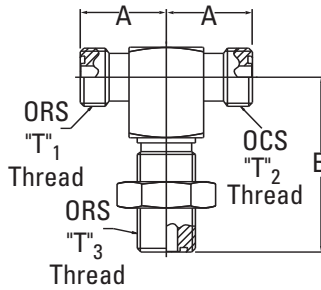

Part No. FF2033T (Size) (Ref. SAE 520959)

Dash Size	Tube O.D.		Thread T1	Thread T2	Thread T3	A		B	
	mm	in				mm	in	mm	in
0404S	6,4	0.25	9/16-18	9/16-18	9/16-18	22,3	0.88	47,0	1.85
0606S	9,7	0.38	11/16-16	11/16-16	11/16-16	25,7	1.01	52,0	2.05
0808S	12,7	0.50	13/16-16	13/16-16	13/16-16	28,7	1.13	55,4	2.18
1010S	16,0	0.63	1-14	1-14	1-14	34,5	1.36	63,0	2.48
1212S	19,0	0.75	13/16-12	13/16-12	13/16-12	40,6	1.60	67,3	2.65
1616S	25,4	1.00	17/16-12	17/16-12	17/16-12	42,4	1.67	71,1	2.80

ORS Accessories

ORS Bulkhead Nut

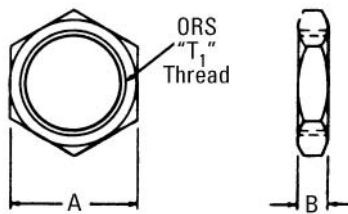

Part No. FF9768-(Dash size) (Ref. SAE 520118)

Dash Size	Tube O.D.		Thread T1	A		B	
	mm	in		mm	in	mm	in
04S	6,4	0.25	9/16-18	20,6	0.81	6,8	0.27
06S	9,7	0.38	11/16-16	25,4	1.00	7,9	0.31
08S	12,7	0.50	13/16-16	28,5	1.12	8,9	0.35
10S	16,0	0.63	1-14	33,3	1.31	10,4	0.41
12S	19,0	0.75	13/16-12	38,1	1.50	10,4	0.41
16S	25,4	1.00	17/16-12	44,4	1.75	10,4	0.41
20S	31,8	1.25	111/16-12	50,8	2.00	10,4	0.41
24S	38,1	1.50	2-12	60,4	2.38	10,4	0.41

SPECIALTY &
TRUCK HOSE

LOW & MEDIUM
PRESSURE HOSE

HIGH PRESSURE HOSE

HOSE FITTINGS

ADAPTERS &
TUBE FITTINGS

ACCESSORIES &
ASSEMBLY INSTRUCTIONS

HOSE ASSEMBLY
EQUIPMENT

APPENDICES

ORS Plug

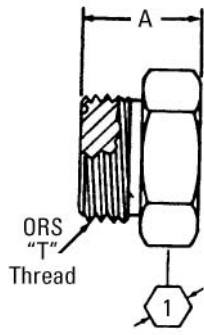

Part No. FF9767-(Dash size) (Ref. SAE 520109)

Dash Size	Tube O.D.		Thread T1	A		①	
	mm	in		mm	in	mm	in
04S	6,4	0.25	9/16-18	16,8	0.66	15,7	0.62
06S	9,7	0.38	11/16-16	19,0	0.75	19,0	0.75
08S	12,7	0.50	13/16-16	22,1	0.87	22,3	0.88
10S	16,0	0.63	1-14	25,9	1.02	26,9	1.06
12S	19,0	0.75	13/16-12	27,4	1.08	31,8	1.25
16S	25,4	1.00	17/16-12	27,9	1.10	38,1	1.50
20S	31,8	1.25	111/16-12	27,9	1.10	44,4	1.75
24S	38,1	1.50	2-12	27,9	1.10	53,9	2.12

ORS Cap Assembly

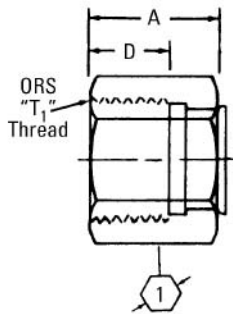

Part No. FF9863-(Dash size) (Ref. SAE 520112)

Dash Size	Tube O.D.		Thread T1	A		D		①	
	mm	in		mm	in	mm	in	mm	in
04S	6,4	0.25	9/16-18	16,8	0.66	8,1	0.32	17,5	0.69
06S	9,7	0.38	11/16-16	19,0	0.75	9,7	0.38	20,6	0.81
08S	12,7	0.50	13/16-16	22,9	0.90	10,9	0.43	23,9	0.94
10S	16,0	0.63	1-14	25,4	1.00	13,5	0.53	28,5	1.12
12S	19,0	0.75	13/16-12	27,9	1.10	14,5	0.57	35,1	1.38
16S	25,4	1.00	17/16-12	29,7	1.17	14,7	0.58	41,1	1.62
20S	31,8	1.25	111/16-12	29,7	1.17	14,7	0.58	47,7	1.88
24S	38,1	1.50	2-12	29,7	1.17	14,7	0.58	57,2	2.25

ORS Cap (use with FC2326 Nut)

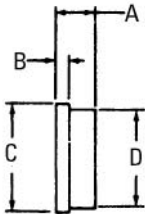

Part No. FF9766-(Dash size)

Dash Size	Tube O.D.		A		B		C		D	
	mm	in	mm	in	mm	in	mm	in	mm	in
04S	6,4	0.25	8,6	0.34	4,1	0.16	12,7	0.50	10,2	0.40
06S	9,7	0.38	9,4	0.37	4,6	0.18	15,7	0.62	13,2	0.52
08S	12,7	0.50	11,9	0.47	5,1	0.20	18,8	0.74	16,2	0.64
10S	16,0	0.63	11,9	0.47	6,1	0.24	23,4	0.92	20,8	0.82
12S	19,0	0.75	13,5	0.53	6,6	0.26	27,7	1.09	23,9	0.94
14S	22,3	0.88	18,0	0.71	11,4	0.45	27,7	1.09	24,6	0.97
16S	25,4	1.00	15,0	0.59	7,1	0.28	34,0	1.34	28,7	1.13
20S	31,8	1.25	15,0	0.59	7,1	0.28	40,4	1.59	35,6	1.40
24S	38,1	1.50	15,0	0.59	7,1	0.28	48,5	1.91	43,4	1.71

ORS Silver Braze Ring

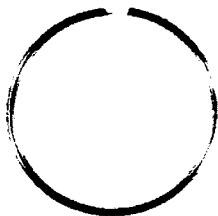

Part No. FF9075-(Size)

Part Number	Tube O.D.	
	mm	in
FF9075-19	6,4	0.25
FF9075-06	9,7	0.38
FF9075-74	12,7	0.50
FF9075-08	16,0	0.63
FF9075-09	19,0	0.75
FF9075-86	25,4	1.00
FF9075-87	31,8	1.25
FF9075-88	38,1	1.50

ORB/ORB

SAE O-Ring Boss Reducer

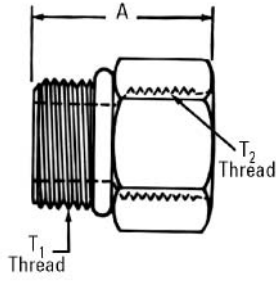

Part No. FF1010-(Dash size)

Dash Size	Thread T1	Thread T2	A	
			mm	in
0408S	7/16-20	3/4-16	32,0	1.26
0806S	3/4-16	9/16-18	26,9	1.06
1006S	7/8-14	9/16-18	20,6	0.81
1008S	7/8-14	3/4-16	31,8	1.25
1206S	1 1/16-12	9/16-18	25,4	1.00
1208S	1 1/16-12	3/4-16	25,4	1.00
1210S	1 1/16-12	7/8-14	36,6	1.44
1216S	1 1/16-12	1 5/16-12	45,5	1.79
1608S	1 5/16-12	3/4-16	25,4	1.00
1610S	1 5/16-12	7/8-14	36,6	1.44
1612S	1 5/16-12	1 1/16-12	40,4	1.59
2012S	1 5/8-12	1 1/16-12	25,4	1.00
2016S	1 5/8-12	1 5/16-12	25,4	1.00

NOTE: Available without O-ring. Order Part No. FF1009-(Dash size).

O-Ring Boss Plug

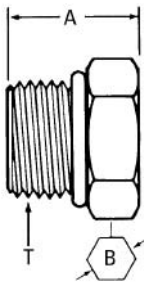

Part No. 900598-(Dash size) (Ref. SAE 090109A)

Dash Size	Thread T	A		B	
		mm	in	mm	in
4S	7/16-20	17,0	0.67	14,2	0.56
5S	1/2-20	17,0	0.67	15,7	0.62
6S	9/16-18	18,5	0.73	17,6	0.69
8S	3/4-16	20,3	0.80	22,4	0.88
10S	7/8-14	23,6	0.93	25,4	1.00
12S	1 1/16-12	27,7	1.09	31,8	1.25
14S	1 3/16-12	27,7	1.09	35,1	1.38
16S	1 5/16-12	28,5	1.12	38,1	1.50
20S	1 5/8-12	30,5	1.20	47,7	1.88
24S	1 7/8-12	32,3	1.27	53,9	2.12
32S	2 1/2-12	36,3	1.43	69,8	2.75

NOTE: Available without O-ring. Order Part No. 900598-1-(Dash size).

SAE Male O-Ring Boss (Hex Socket)

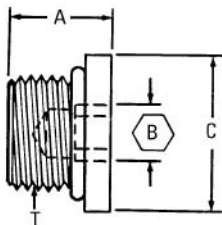

Part No. FF2138-(Dash size) (Ref. SAE 090191B)

Dash Size	Tube O.D.		Thread T	A		C (Round)		B (Hex)	
	mm	in		mm	in	mm	in	mm	in
-02S	3,3	0.13	5/16-24	9,7	0.38	11,2	0.44	3,3	0.13
-03S	4,8	0.19	3/8-24	9,7	0.38	12,7	0.50	3,3	0.13
-04S	6,3	0.25	7/16-20	11,4	0.45	14,2	0.56	4,8	0.19
-05S	7,9	0.31	1/2-20	11,4	0.45	15,7	0.62	4,8	0.19
-06S	9,6	0.38	9/16-18	12,2	0.48	17,6	0.69	6,4	0.25
-08S	12,7	0.50	3/4-16	14,2	0.56	22,4	0.88	7,9	0.31
-10S	16,0	0.63	7/8-14	16,0	0.63	25,4	1.00	9,7	0.38
-12S	19,0	0.75	1 1/16-12	19,0	0.75	31,8	1.25	14,2	0.56
-16S	25,4	1.00	1 5/16-12	19,5	0.77	38,1	1.50	16,0	0.63

NOTE: Available without O-ring. Order Part No. FF2137-(Dash size).

ORB/Adjustable ORB

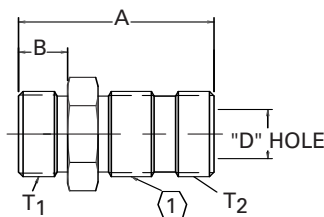

Part No. 2220-(Dash Size)

Dash Size	Tube O.D.		Thread T1	Thread T2	A		B		D	
	mm	in			mm	in	mm	in		
6-6S	9,7	0.38	9/16-18	9/16-18	37,8	1.49	21,6	0.85	17,5	0.69
10-10S	16,0	0.63	7/8-14	7/8-14	50,5	1.99	30,0	1.18	25,4	1.00
12-12S	19,0	0.75	1 1/16-12	1 1/16-12	58,4	2.30	33,6	1.32	31,8	1.25
16-16S	25,4	1.00	1 5/16-12	1 5/16-12	54,1	2.13	29,5	1.16	38,1	1.50

Male ORB/Male ORB

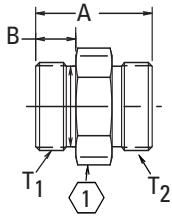

Part No. 2229-(Dash Size)

Dash Size	Tube O.D.		Thread T1	Thread T2	A		B		①	
	mm	in			mm	in	mm	in	mm	in
8-8S	12,7	0.50	3/4-16	3/4-16	30,3	1.19	11,2	0.44	22,3	0.88
8-10S	16,0	0.63	7/8-14	3/4-16	35,3	1.39	11,2	0.44	25,4	1.00
16-16S	25,4	1.00	1 5/16-12	1 5/16-12	43,9	1.73	15,0	0.59	38,1	1.50

90° Female ORB/Adjustable ORB Male

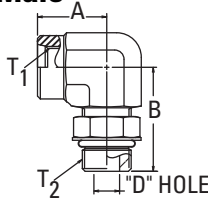

Part No. FF2591- (Dash Size)

Dash Size	Tube O.D.		Thread T1	Thread T2	A		B	
	mm	in			mm	in	mm	in
0404S	6,4	0.25	7/16-20	7/16-20	21,6	0.85	32,0	1.26

SAE O-Ring Boss (adj.)/ Hose Connector

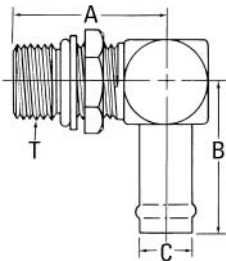

Part No. FF1167-(Dash size)

Dash Size	Tube O.D.		Thread T1	A		B		C	
	mm	in		mm	in	mm	in	mm	in
1010S	16,0	0.63	7/8-14	43,4	1.71	52,3	2.06	15,7	0.62
1212S	19,0	0.75	1 1/16-12	49,3	1.94	53,1	2.09	19,0	0.75
1220S	31,7	1.25	1 1/16-12	51,3	2.02	55,6	2.19	31,8	1.25
2020S	31,7	1.25	1 5/8-12	55,9	2.20	60,4	2.38	31,8	1.25

NOTE: Available without O-ring. Order by Part No. FF1161-(Dash size). Clamp required.

Pipe to Pipe

Part No. 2083-(Dash size) (Ref. SAE 140137)

Dash Size	Thread P1	Thread P2	A	
			mm	in
2-2S	1/8-27	1/8-27	26,9	1.06
4-2S	1/4-18	1/8-27	32,0	1.26
4-4S	1/4-18	1/4-18	36,8	1.45
6-4S	3/8-18	1/4-18	36,8	1.45
6-6S	3/8-18	3/8-18	36,8	1.45
8-4S	1/2-14	1/4-18	43,2	1.70
8-6S	1/2-14	3/8-18	43,2	1.70
8-8S	1/2-14	1/2-14	48,0	1.89
12-6S	3/4-14	3/8-18	44,9	1.77
12-8S	3/4-14	1/2-14	49,8	1.96
12-12S	3/4-14	3/4-14	49,8	1.96
16-12S	1-11 1/2	3/4-14	54,6	2.15
16-16S	1-11 1/2	1-11 1/2	59,4	2.34
20-16S	1 1/4-11 1/2	1-11 1/2	62,2	2.45
20-20S	1 1/4-11 1/2	1 1/4-11 1/2	63,0	2.48
24-24S	1 1/2-11 1/2	1 1/2-11 1/2	66,3	2.61
32-32S	2-11 1/2	2-11 1/2	71,6	2.82

Also available in stainless steel as part no. 259-2083. See pg. 277 for more information.

External Pipe/ External Pipe (NPSM)

Part No. 2015-(Dash size)

Dash Size	Thread P1	Thread P2	A	
			mm	in
8-8S	1/2-14	1/2-14	38,1	1.50
12-12S	3/4-14	3/4-14	41,1	1.62
16-16S	1-11 1/2	1-11 1/2	48,5	1.91
24-24S	1 1/2-11 1/2	1 1/2-11 1/2	41,1	1.62

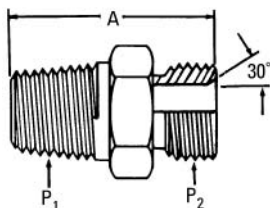

Nipple-External Pipe/External Pipe

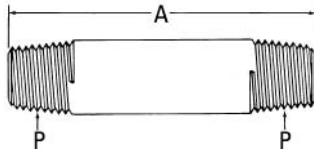

Part No. 2084-(Dash size)

Dash Size	Thread P	A	
		mm	in
2S-3/4	1/8-27	19,0	0.75
2S-2	1/8-27	50,8	2.00
4S-7/8	1/4-18	22,3	0.88
6S-1	3/8-18	25,4	1.00
6S-2	3/8-18	50,8	2.00
6S-3	3/8-18	76,2	3.00
6S-4	3/8-18	101,6	4.00
6S-6	3/8-18	152,4	6.00
8S-11/8	1/2-14	28,5	1.12
8S-21/2	1/2-14	63,5	2.50
12S-13/8	3/4-14	35,1	1.38
16S-11/2	1-11 1/2	38,1	1.50
20S-15/8	1 1/4-11 1/2	41,1	1.62
24S-13/4	1 1/2-11 1/2	44,4	1.75

Reducer-External Pipe/Internal Pipe

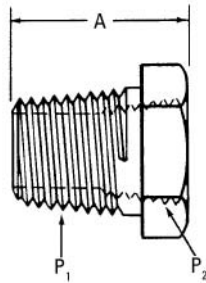

Part No. 2081-(Dash size) (Ref. SAE 140140)

Dash Size	Thread P1	Thread P2	A	
			mm	in
4-2S	1/4-18	1/8-27	21,6	0.85
6-2S	3/8-18	1/8-27	25,4	1.00
6-4S	3/8-18	1/4-18	21,6	0.85
8-2S	1/2-14	1/8-27	27,9	1.10
8-4S	1/2-14	1/4-18	27,9	1.10
8-6S	1/2-14	3/8-18	28,5	1.12
12-4S	3/4-14	1/4-14	29,7	1.17
12-6S	3/4-14	3/8-18	29,7	1.17
12-8S	3/4-14	1/2-14	34,5	1.36
16-6S	1-11 1/2	3/8-14	34,5	1.36
16-8S	1-11 1/2	1/2-14	34,5	1.36
16-12S	1-11 1/2	3/4-14	37,8	1.49
20-12S	1 1/4-11 1/2	3/4-14	37,3	1.47
20-16S	1 1/4-11 1/2	1-11 1/2	40,9	1.61
24-12S	1 1/2-11 1/2	3/4-14	39,9	1.57
24-16S	1 1/2-11 1/2	1-11 1/2	39,9	1.57
24-20S	1 1/2-11 1/2	1 1/4-11 1/2	43,4	1.71
32-16S	2-11 1/2	1-11 1/2	44,4	1.75
32-20S	2-11 1/2	1 1/4-11 1/2	44,4	1.75
32-24S	2-11 1/2	1 1/2-11 1/2	44,4	1.75

Also available in stainless steel as part no. 259-2081.
See pg. 277 for more information.

External Pipe/Plug

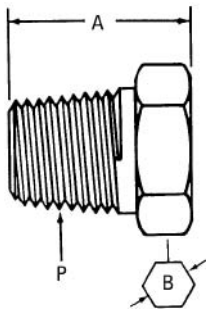

Part No. 2082-(Dash size) (Ref. SAE 140109E)

Dash Size	Thread P1	A		B	
		mm	in	mm	in
2S	1/8-27	14,7	0.58	11,2	0.44
4S	1/4-18	19,3	0.76	14,2	0.56
6S	3/8-18	20,1	0.79	17,5	0.69
8S	1/2-14	24,9	0.98	22,3	0.88
12S	3/4-14	27,4	1.08	26,9	1.06
16S	1-11 1/2	32,3	1.27	33,3	1.31
20S	1 1/4-11 1/2	33,0	1.30	44,4	1.75
24S	1 1/2-11 1/2	33,8	1.33	50,8	2.00

Also available in stainless steel as part no. 259-2082.
See pg. 277 for more information.

External Pipe/Plug Countersunk Hex

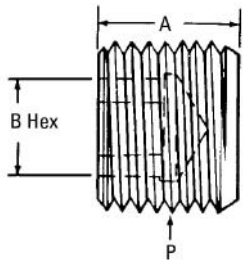

Part No. 2222-(Dash size) (Ref. SAE 140109N)

Dash Size	Thread P1	A		B	
		mm	in	mm	in
2S	1/8-27	7,6	0.30	4,8	0.19
4S	1/4-18	11,7	0.46	6,4	0.25
6S	3/8-18	11,7	0.46	7,9	0.31
8S	1/2-14	15,5	0.61	9,7	0.38

External Pipe/ Internal Pipe

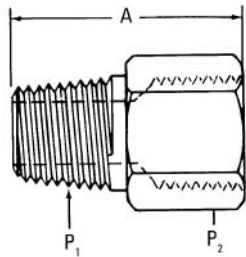

Part No. 2040-(Dash size) (Ref. SAE 140139)

Dash Size	Thread P1	Thread P2	A	
			mm	in
2-2S	1/8-27	1/8-27	26,4	1.04
2-4S	1/8-27	1/4-18	30,7	1.21
4-4S	1/4-18	1/4-18	35,3	1.39
4-6S	1/4-18	3/8-18	36,6	1.44
4-8S	1/4-18	1/2-14	42,7	1.68
6-6S	3/8-18	3/8-18	36,6	1.44
6-8S	3/8-18	1/2-14	42,7	1.68
8-8S	1/2-14	1/2-14	47,5	1.87
8-12S	1/2-14	3/4-14	49,0	1.93
12-12S	3/4-14	3/4-14	49,0	1.93
12-16S	3/4-14	1-11 1/2	55,4	2.18
16-16S	1-11 1/2	1-11 1/2	60,2	2.37
16-20S	1-11 1/2	1 1/4-11 1/2	62,5	2.46
20-20S	1 1/4-11 1/2	1 1/4-11 1/2	63,2	2.49
20-24S	1 1/4-11 1/2	1 1/2-11 1/2	63,5	2.50
24-24S	1 1/2-11 1/2	1 1/2-11 1/2	64,3	2.53
32-32S	2-11 1/2	2-11 1/2	67,6	2.66

Internal Pipe Swivel (NPSM)/External Pipe

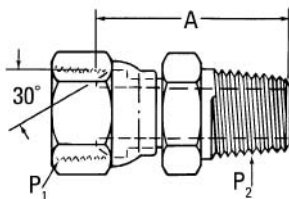

Part No. 2045-(Dash size) (Ref. SAE 140130)

Dash Size	Thread P1	Thread P2	A	
			mm	in
2-2S	1/8-27	1/8-27	24,4	0.96
2-4S	1/8-27	1/4-18	29,0	1.14
4-4S	1/4-18	1/4-18	32,0	1.26
4-6S	1/4-18	3/8-18	32,0	1.26
6-4S	3/8-18	1/4-18	32,0	1.26
6-6S	3/8-18	3/8-18	33,6	1.32
6-8S	3/8-18	1/2-14	40,1	1.58
8-6S	1/2-14	3/8-18	34,8	1.37
8-8S	1/2-14	1/2-14	41,1	1.62
8-12S	1/2-14	3/4-14	41,1	1.62
12-12S	3/4-14	3/4-14	44,4	1.75
12-16S	3/4-14	1-11 1/2	50,8	2.00
16-12S	1-11 1/2	3/4-14	44,7	1.76
16-16S	1-11 1/2	1-11 1/2	51,3	2.02
20-20S	1 1/4-11 1/2	1 1/4-11 1/2	52,8	2.08
24-24S	1 1/2-11 1/2	1 1/2-11 1/2	55,9	2.20
32-32S	2-11 1/2	2-11 1/2	60,7	2.39

Pipe to Pipe

Internal Pipe Swivel (NPSM)/Internal Pipe

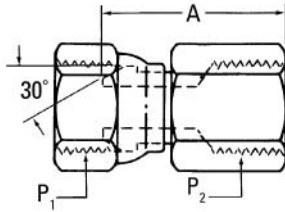

Part No. 2046-(Dash size) (Ref. SAE 140131)

Dash Size	Thread P1	Thread P2	A	
			mm	in
2-2S	1/8-27	1/8-27	21,3	0.84
2-4S	1/8-27	1/4-18	26,9	1.06
4-4S	1/4-18	1/4-18	33,0	1.30
4-6S	1/4-18	3/8-18	33,3	1.31
6-6S	3/8-18	3/8-18	33,8	1.33
6-8S	3/8-18	1/2-14	36,8	1.45
8-8S	1/2-14	1/2-14	39,6	1.56
12-12S	3/4-14	3/4-14	44,9	1.77
16-16S	1-11 1/2	1-11 1/2	52,3	2.06
20-20S	1 1/4-11 1/2	1 1/2-11 1/2	52,3	2.06
24-24S	1 1/2-11 1/2	1 1/2-11 1/2	55,4	2.18
32-32S	2-11 1/2	2-11 1/2	58,4	2.30

Coupling - Internal Pipe/Internal Pipe

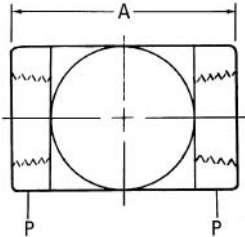

Part No. 2096-(Dash size) (Ref. SAE 140138)

Dash Size	Thread P	A	
		mm	in
2S	1/8-27	19,0	0.75
4S	1/4-18	28,7	1.13
6S	3/8-18	28,7	1.13
8S	1/2-14	38,1	1.50
12S	3/4-14	38,9	1.53
16S	1-11 1/2	48,0	1.89
20S	1 1/4-11 1/2	49,0	1.93
24S	1 1/2-11 1/2	49,0	1.93

Also available in stainless steel as part no. 259-2096. See pg. 279 for more information.

External Pipe/External Pipe

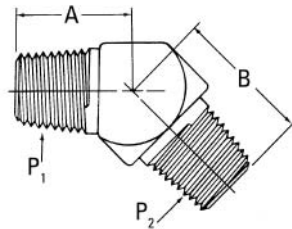

Part No. 2247-(Dash size) (Ref. SAE 140337)

Dash Size	Thread P1	Thread P2	A		B	
			mm	in	mm	in
2-2S	1/8-27	1/8-27	13,2	0.52	13,2	0.52
4-4S	1/4-18	1/4-18	21,8	0.86	21,8	0.86
6-4S	3/8-18	1/4-18	24,1	0.95	24,1	0.95
6-6S	3/8-18	3/8-18	24,1	0.95	24,1	0.95
8-8S	1/2-14	1/2-14	28,7	1.13	29,7	1.17
12-12S	3/4-14	3/4-14	29,7	1.17	30,5	1.20
16-16S	1-11 1/2	1-11 1/2	30,5	1.20	37,6	1.48
20-20S	1 1/4-11 1/2	1 1/4-11 1/2	47,7	1.88	39,1	1.54

Internal Pipe Swivel (NPSM)/Internal Pipe

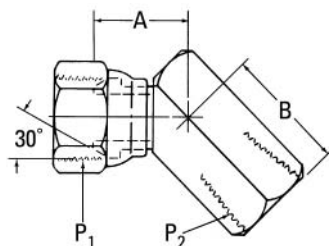

Part No. 2050-(Dash size) (Ref. SAE 140331)

Dash Size	Thread P1	Thread P2	A		B	
			mm	in	mm	in
4-4S	1/4-18	1/4-18	20,1	0.79	24,6	0.97
6-6S	3/8-18	3/8-18	23,4	0.92	30,0	1.18
8-8S	1/2-14	1/2-14	23,1	0.91	35,8	1.41
12-12S	3/4-14	3/4-14	27,9	1.10	38,9	1.53
16-16S	1-11 1/2	1-11 1/2	32,0	1.26	38,9	1.53
20-20S	1 1/4-11 1/2	1 1/4-11 1/2	36,8	1.45	46,0	1.81

SPECIALTY & TRUCK HOSE

LOW & MEDIUM PRESSURE HOSE

HIGH PRESSURE HOSE

HOSE FITTINGS

ADAPTERS & TUBE FITTINGS

ACCESSORIES & ASSEMBLY INSTRUCTIONS

HOSE ASSEMBLY EQUIPMENT

APPENDICES

Internal Pipe Swivel (NPSM)/External Pipe

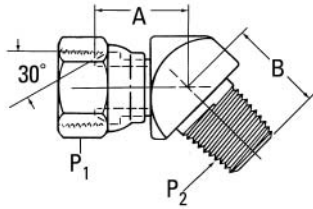

Part No. 2049-(Dash size) (Ref. SAE 140330)

Dash Size	Thread P1		Thread P2		A		B	
	mm	in	mm	in	mm	in	mm	in
2-2S	1/8-27	1/8-27	17,0	0.67	17,8	0.70		
4-4S	1/4-18	1/4-18	20,1	0.79	20,1	0.79		
6-6S	3/8-18	3/8-18	23,4	0.92	27,7	1.09		
6-8S	3/8-18	1/2-14	23,4	0.92	35,8	1.41		
8-6S	1/2-14	3/8-18	23,1	0.91	27,7	1.09		
8-8S	1/2-14	1/2-14	23,1	0.91	33,8	1.33		
12-12S	3/4-14	3/4-14	27,9	1.10	38,9	1.53		
16-16S	1-11 1/2	1-11 1/2	32,0	1.26	38,9	1.53		
20-20S	1 1/4-11 1/2	1 1/4-11 1/2	31,8	1.25	44,4	1.75		
24-24S	1 1/2-11 1/2	1 1/2-11 1/2	35,8	1.41	50,8	2.00		
32-32S	2-11 1/2	2-11 1/2	38,1	1.50	50,8	2.00		

External Pipe/ Internal Pipe

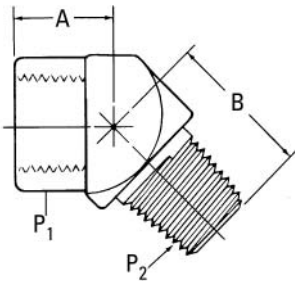

Part No. 2088-(Dash size) (Ref. SAE 140339)

Dash Size	Thread P1		Thread P2		A		B	
	mm	in	mm	in	mm	in	mm	in
2-2S	1/8-27	1/8-27	11,9	0.47	18,3	0.72		
4-4S	1/4-18	1/4-18	15,7	0.62	26,7	1.05		
6-6S	3/8-18	3/8-18	18,3	0.72	26,9	1.06		
8-8S	1/2-14	1/2-14	23,1	0.91	34,0	1.34		
12-12S	3/4-14	3/4-14	24,6	0.97	35,1	1.38		
16-16S	1-11 1/2	1-11 1/2	28,5	1.12	43,7	1.72		

Also available in stainless steel as part no. 259-2088.
See pg. 278 for more information.

External Pipe/ External Pipe

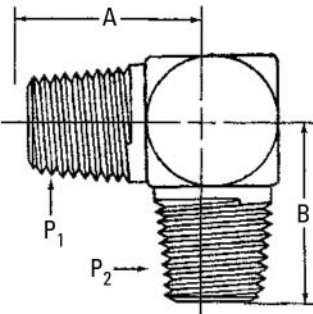

Part No. 2085-(Dash size) (Ref. SAE 140237)

Dash Size	Thread P1		Thread P2		A		B	
	mm	in	mm	in	mm	in	mm	in
2-2S	1/8-27	1/8-27	19,8	0.78	19,8	0.78		
4-4S	1/4-18	1/4-18	27,7	1.09	27,7	1.09		
6-4S	3/8-18	1/4-18	31,0	1.22	31,0	1.22		
6-6S	3/8-18	3/8-18	31,0	1.22	31,0	1.22		
8-6S	1/2-14	3/8-18	37,3	1.47	32,5	1.28		
8-8S	1/2-14	1/2-14	37,3	1.47	37,3	1.47		
12-8S	3/4-14	1/2-14	40,4	1.59	40,4	1.59		
12-12S	3/4-14	3/4-14	40,4	1.59	40,4	1.59		
16-12S	1-11 1/2	3/4-14	50,0	1.97	45,2	1.78		
16-16S	1-11 1/2	1-11 1/2	50,0	1.97	50,0	1.97		

Also available in stainless steel as part no. 259-2085.
See pg. 277 for more information.

External Pipe/ Hose Connector*

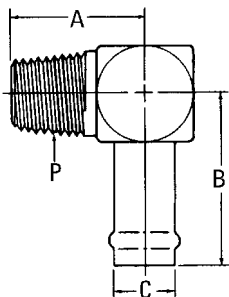

Part No. FF1162-(Dash size) (Ref. SAE 430260)

Dash Size	Tube O.D.		Thread T1		A		B		C	
	mm	in	mm	in	mm	in	mm	in	mm	in
0406S	9,7	0.38	1/4-18	24,4	0.96	39,1	1.54	9,7	0.38	
1212S	19,0	0.75	3/4-14	35,8	1.41	46,5	1.83	19,0	0.75	
1616S	25,4	1.00	1-11 1/2	43,4	1.71	49,3	1.94	25,4	1.00	
2020S	31,8	1.25	1 1/4-11 1/2	49,8	1.96	54,6	2.15	31,8	1.25	

*Clamp required.

SPECIALTY & TRUCK HOSE
LOW & MEDIUM PRESSURE HOSE
HIGH PRESSURE HOSE
HOSE FITTINGS
ADAPTERS & TUBE FITTINGS
ACCESSORIES & ASSEMBLY INSTRUCTIONS
HOSE ASSEMBLY EQUIPMENT
APPENDICES

External Pipe Swivel/External Pipe

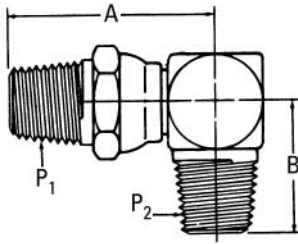

Part No. 2251-(Dash size)

Dash Size	Thread P1	Thread P2	A		B	
			mm	in	mm	in
4-4S	1/4-18	1/4-18	43,7	1.72	27,7	1.09
6-6S	3/8-18	3/8-18	45,2	1.78	31,0	1.22
8-8S	1/2-14	1/2-14	41,1	1.62	37,3	1.47
12-12S	3/4-14	3/4-14	59,2	2.33	37,3	1.47

NOTE: The above adapter is not a rotating union or swivel joint. Care must be exercised to avoid misuse. To be used with petroleum or water glycol fluids.

External Pipe/Internal Pipe

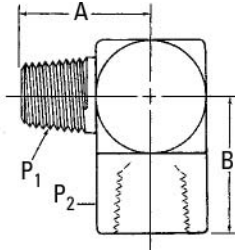

Part No. 2089-(Dash size) (Ref. SAE 140239)

Dash Size	Thread P1	Thread P2	A		B	
			mm	in	mm	in
2-2S	1/8-27	1/8-27	19,8	0.78	16,8	0.66
2-4S	1/8-27	1/4-18	22,9	0.90	22,3	0.88
4-2S	1/4-18	1/8-27	27,7	1.09	17,0	0.67
4-4S	1/4-18	1/4-18	27,7	1.09	22,3	0.88
4-6S	1/4-18	3/8-18	31,0	1.22	25,9	1.02
6-4S	3/8-18	1/4-18	31,0	1.22	25,7	1.01
6-6S	3/8-18	3/8-18	31,0	1.22	25,9	1.02
6-8S	3/8-18	1/2-14	32,5	1.28	31,2	1.23
8-6S	1/2-14	3/8-18	37,3	1.47	25,7	1.01
8-8S	1/2-14	1/2-14	37,3	1.47	31,2	1.23
8-12S	1/2-14	3/4-14	40,4	1.59	34,5	1.36
12-8S	3/4-14	1/2-14	40,4	1.59	34,3	1.35
12-12S	3/4-14	3/4-14	40,4	1.59	34,5	1.36
16-16S	1-11 1/2	1-11 1/2	50,0	1.97	41,1	1.62
20-20S	1 1/4-11 1/2	1 1/4-11 1/2	60,4	2.38	43,2	1.70
24-24S	1 1/2-11 1/2	1 1/2-11 1/2	67,0	2.64	52,8	2.08

Also available in stainless steel as part no. 259-2089. See pg. 278 for more information.

External Pipe Swivel/Internal Pipe

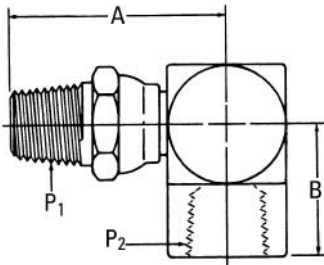

Part No. 2252-(Dash size)

Dash Size	Thread P1	Thread P2	A		B	
			mm	in	mm	in
4-4S	1/4-18	1/4-18	43,7	1.72	22,3	0.88
6-6S	3/8-18	3/8-18	42,9	1.69	25,9	1.02
8-8S	1/2-14	1/2-14	41,1	1.62	31,2	1.23
12-12S	3/4-14	3/4-14	57,2	2.25	34,5	1.36

NOTE: The above adapter is not a rotating swivel joint. Care must be exercised to avoid misuse. This adapter is to be used with petroleum or water glycol fluids.

Internal Pipe Swivel (NPSM)/Internal Pipe

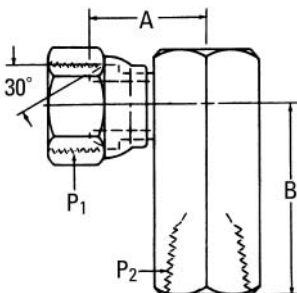

Part No. 2048-(Dash size) (Ref. SAE 140231)

Dash Size	Thread P1	Thread P2	A		B	
			mm	in	mm	in
4-4S	1/4-18	1/4-18	23,1	0.91	24,6	0.97
6-6S	3/8-18	3/8-18	27,7	1.09	27,7	1.09
8-8S	1/2-14	1/2-14	27,4	1.08	34,0	1.34
12-12S	3/4-14	3/4-14	34,5	1.36	38,9	1.53
16-16S	1-11 1/2	1-11 1/2	38,9	1.53	45,2	1.78
20-20S	1 1/4-11 1/2	1 1/4-11 1/2	46,2	1.82	51,6	2.03
24-24S	1 1/2-11 1/2	1 1/2-11 1/2	51,3	2.02	57,9	2.28

Internal Pipe Swivel (NPSM)/External Pipe

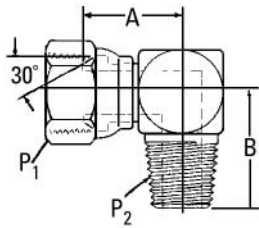

Part No. 2047-(Dash size) (Ref. SAE 140230)

Dash Size	Thread P1	Thread P2	A		B	
			mm	in	mm	in
2-2S	1/8-27	1/8-27	18,0	0.71	26,2	1.03
4-4S	1/4-18	1/4-18	23,1	0.91	32,5	1.28
4-6S	1/4-18	3/8-18	27,7	1.09	38,9	1.53
6-6S	3/8-18	3/8-18	27,7	1.09	38,9	1.53
6-8S	3/8-18	1/2-14	26,2	1.03	46,7	1.84
8-6S	1/2-14	3/8-18	27,4	1.08	41,9	1.65
8-8S	1/2-14	1/2-14	27,4	1.08	46,7	1.84
8-12S	1/2-14	3/4-14	31,5	1.24	51,6	2.03
12-8S	3/4-14	1/2-14	34,5	1.36	51,6	2.03
12-12S	3/4-14	3/4-14	34,5	1.36	51,6	2.03
12-16S	3/4-14	1-11 1/2	38,3	1.51	61,2	2.41
16-12S	1-11 1/2	3/4-14	38,9	1.53	56,4	2.22
16-16S	1-11 1/2	1-11 1/2	38,9	1.53	61,2	2.41
20-20S	1 1/4-11 1/2	1 1/4-11 1/2	46,2	1.82	67,3	2.65
24-24S	1 1/2-11 1/2	1 1/2-11 1/2	51,3	2.02	72,1	2.84
32-32S	2-11 1/2	2-11 1/2	60,2	2.37	84,8	3.34

Internal Pipe/ Internal Pipe

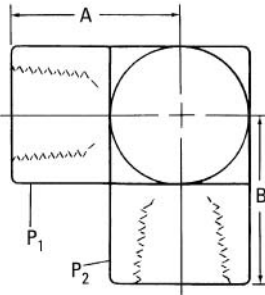

Part No. 2087-(Dash size) (Ref. SAE 140238)

Dash Size	Thread P1	Thread P2	A		B	
			mm	in	mm	in
2-2S	1/8-27	1/8-27	16,8	0.66	16,8	0.66
4-2S	1/4-18	1/8-27	22,3	0.88	17,0	0.67
4-4S	1/4-18	1/4-18	22,3	0.88	22,3	0.88
6-4S	3/8-18	1/4-18	25,9	1.02	25,7	1.01
6-6S	3/8-18	3/8-18	25,9	1.02	25,9	1.02
8-6S	1/2-14	3/8-18	31,2	1.23	25,7	1.01
8-8S	1/2-14	1/2-14	31,2	1.23	31,2	1.23
12-8S	3/4-14	1/2-14	34,5	1.36	34,3	1.35
12-12S	3/4-14	3/4-14	34,5	1.36	34,5	1.36
16-12S	1-11 1/2	3/4-14	41,1	1.62	35,3	1.39
16-16S	1-11 1/2	1-11 1/2	41,1	1.62	41,1	1.62
20-20S	1 1/4-11 1/2	1 1/4-11 1/2	43,2	1.70	43,2	1.70
24-24S	1 1/2-11 1/2	1 1/2-11 1/2	52,8	2.08	52,8	2.08

Also available in stainless steel as part no. 259-2087.
See pg. 278 for more information.

External Pipe/ External Pipe

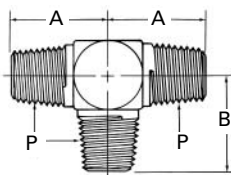

Part No. 2257-(Dash size)

Dash Size	Thread P1	A		B	
		mm	in	mm	in
2-2S	1/8-27	19,8	0.78	19,8	0.78
4-4S	1/4-18	27,7	1.09	27,7	1.09
6-6S	3/8-18	31,0	1.22	31,0	1.22
8-8S	1/2-14	37,3	1.47	37,3	1.47
12-12S	3/4-14	40,4	1.59	40,4	1.59
16-16S	1-11 1/2	50,0	1.97	50,0	1.97

External Pipe/ Internal Pipe

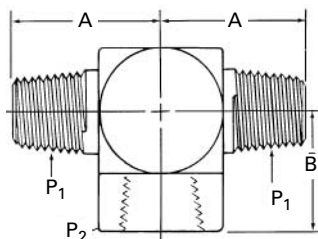

Part No. 2256-(Dash size)

Dash Size	Thread P1	Thread P2	A		B	
			mm	in	mm	in
2-2S	1/8-27	1/8-27	19,8	0.78	16,8	0.66
4-4S	1/4-18	1/4-18	27,7	1.09	22,3	0.88
6-6S	3/8-18	3/8-18	31,0	1.22	25,9	1.02
8-8S	1/2-14	1/2-14	37,3	1.47	31,2	1.23
12-12S	3/4-14	3/4-14	40,4	1.59	34,5	1.36
16-16S	1-11 1/2	1-11 1/2	53,6	2.11	41,1	1.62

Pipe to Pipe

External Pipe/ Internal Pipe

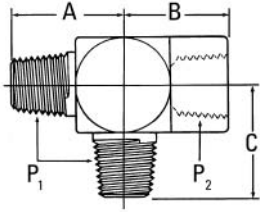

External Pipe/ Internal Pipe

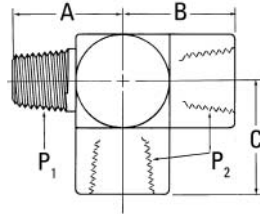

Internal Pipe Swivel (NPSM)/External Pipe

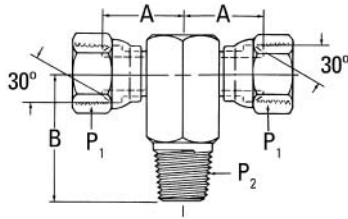

Internal Pipe Swivel (NPSM)

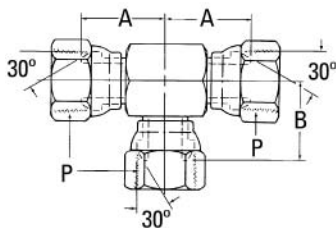

Internal Pipe Swivel (NPSM)/Internal Pipe

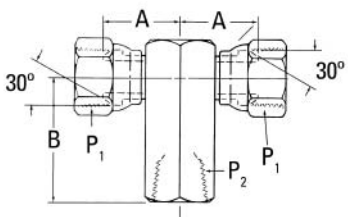

Part No. 2093-(Dash size)

Dash Size	Thread P1	Thread P2	A		B		C	
			mm	in	mm	in	mm	in
2-2S	1/8-27	1/8-27	19,8	0.78	16,8	0.66	19,8	0.78
4-4S	1/4-18	1/4-18	27,7	1.09	22,3	0.88	27,7	1.09
6-6S	3/8-18	3/8-18	31,0	1.22	25,9	1.02	31,0	1.22
8-8S	1/2-14	1/2-14	37,3	1.47	31,2	1.23	37,3	1.47
12-12S	3/4-14	3/4-14	40,4	1.59	34,5	1.36	40,4	1.59
16-16S	1-11 1/2	1-11 1/2	50,0	1.97	41,1	1.62	50,0	1.97

Part No. 2092-(Dash size) (Ref. SAE 140424)

Dash Size	Thread P1	Thread P2	A		B		C	
			mm	in	mm	in	mm	in
2-2S	1/8-27	1/8-27	19,8	0.78	16,8	0.66	16,8	0.66
4-4S	1/4-18	1/4-18	27,7	1.09	22,3	0.88	22,3	0.88
6-6S	3/8-18	3/8-18	31,0	1.22	25,9	1.02	25,9	1.02
8-8S	1/2-14	1/2-14	37,3	1.47	31,2	1.23	31,2	1.23
12-12S	3/4-14	3/4-14	40,4	1.59	34,5	1.36	34,5	1.36
16-16S	1-11 1/2	1-11 1/2	50,0	1.97	41,1	1.62	41,1	1.62
20-20S	1 1/4-11 1/2	1 1/4-11 1/2	71,9	2.83	49,5	1.95	44,7	1.76

Also available in stainless steel as part no. 259-2092. See pg. 279 for more information.

Part No. 2254-(Dash size)

Dash Size	Thread P1	Thread P2	A		B	
			mm	in	mm	in
2-2S	1/8-27	1/8-27	18,0	0.71	23,4	0.92
4-4S	1/4-18	1/4-18	23,1	0.91	31,2	1.23
6-6S	3/8-18	3/8-18	27,7	1.09	38,9	1.53
8-8S	1/2-14	1/2-14	25,4	1.00	46,0	1.81
12-12S	3/4-14	3/4-14	34,5	1.36	51,6	2.03
16-16S	1-11 1/2	1-11 1/2	34,0	1.34	60,4	2.38
20-20S	1 1/4-11 1/2	1 1/4-11 1/2	38,1	1.50	65,0	2.56

Part No. 2255-(Dash size)

Dash Size	Thread P1	A		B	
		mm	in	mm	in
2-2S	1/8-27	18,0	0.71	18,0	0.71
4-4S	1/4-18	23,1	0.91	23,1	0.91
6-6S	3/8-18	2,3	0.09	27,7	1.09
8-8S	1/2-14	27,4	1.08	27,4	1.08
12-12S	3/4-14	34,5	1.36	34,5	1.36
16-16S	1-11 1/2	38,9	1.53	38,9	1.53

Part No. 2253-(Dash size)

Dash Size	Thread P1	Thread P2	A		B	
			mm	in	mm	in
4-4S	1/4-18	1/4-18	27,4	1.08	24,6	0.97
6-6S	3/8-18	3/8-18	32,0	1.26	27,7	1.09
8-8S	1/2-14	1/2-14	32,3	1.27	34,0	1.34
12-12S	3/4-14	3/4-14	40,4	1.59	38,9	1.53
16-16S	1-11 1/2	1-11 1/2	46,2	1.82	45,2	1.78

SPECIALTY &
TRUCK HOSE

LOW & MEDIUM
PRESSURE HOSE

HIGH PRESSURE HOSE

HOSE FITTINGS

ADAPTERS &
TUBE FITTINGS

ACCESSORIES &
ASSEMBLY INSTRUCTIONS

HOSE ASSEMBLY
EQUIPMENT

APPENDICES

External Pipe/ Internal Pipe

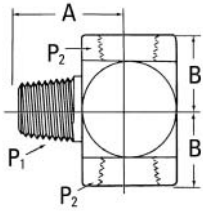

Part No. 2091-(Dash size) (Ref. SAE 140425)

Dash Size	Thread P1	Thread P2	A		B	
			mm	in	mm	in
2-2S	1/8-27	1/8-27	19,8	0.78	16,8	0.66
4-4S	1/4-18	1/4-18	27,7	1.09	22,3	0.88
6-6S	3/8-18	3/8-18	31,0	1.22	25,9	1.02
8-8S	1/2-14	1/2-14	37,3	1.47	31,2	1.23
12-12S	3/4-14	3/4-14	40,4	1.59	34,5	1.36
16-16S	1-11 1/2	1-11 1/2	50,0	1.97	41,1	1.62

Also available in stainless steel as part no. 259-2091.
See pg. 278 for more information.

Internal Pipe/ Internal Pipe

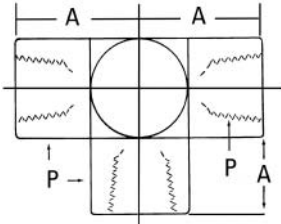

Part No. 2090-(Dash size) (Ref. SAE 140438)

Dash Size	Thread P	A	
		mm	in
2-2S	1/8-27	16,8	0.66
4-4S	1/4-18	22,3	0.88
6-6S	3/8-18	25,9	1.02
8-8S	1/2-14	31,2	1.23
12-12S	3/4-14	34,5	1.36
16-16S	1-11 1/2	41,1	1.62
20-20S	1 1/4-11 1/2	43,2	1.70
24-24S	1 1/2-11 1/2	52,8	2.08

Also available in stainless steel as part no. 259-2090.
See pg. 278 for more information.

External Pipe/ Internal Pipe

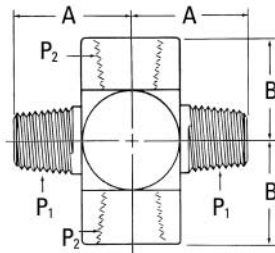

Part No. 208006-(Dash size)

Dash Size	Thread P1	Thread P2	A		B	
			mm	in	mm	in
4-4S	1/4-18	1/4-18	29,5	1.16	22,3	0.88
6-6S	3/8-18	3/8-18	33,0	1.30	25,9	1.02
20-20S	1 1/4-11 1/2	1 1/4-11 1/2	67,3	2.65	3,2	1.70

External Pipe/ Internal Pipe

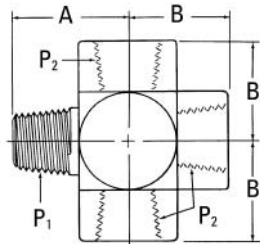

Part No. 208007-(Dash size)

Dash Size	Thread P1	Thread P2	A		B	
			mm	in	mm	in
4-4S	1/4-18	1/4-18	29,5	1.16	22,3	0.88
6-6S	3/8-18	3/8-18	33,0	1.30	25,9	1.02
8-8S	1/2-14	1/2-14	41,4	1.63	31,2	1.23
12-12S	3/4-14	3/4-14	43,9	1.73	34,5	1.36

Internal Pipe/ Internal Pipe

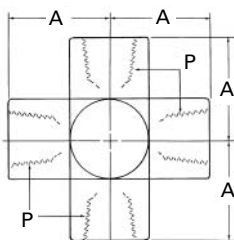

Part No. 2080-(Dash size)

Dash Size	Thread P	A	
		mm	in
2-2S	1/8-27	16,8	0.66
4-4S	1/4-18	22,3	0.88
6-6S	3/8-18	25,9	1.02
8-8S	1/2-14	31,2	1.23
12-12S	3/4-14	34,5	1.36
16-16S	1-11 1/2	41,1	1.62

Pipe to 37° Flare

External Pipe/ 37° Flare

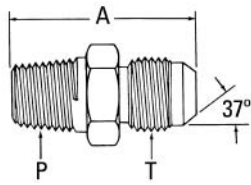

Part No. 2021-(Dash size) (Ref. SAE 070102)

Dash Size	Tube O.D.		Thread P	Thread T	A	
	mm	in			mm	in
2-3S	4,8	0.19	1/8-27	3/8-24	29,0	1.14
2-4S	6,3	0.25	1/8-27	7/16-20	31,0	1.22
2-5S	7,9	0.31	1/8-27	1/2-20	31,0	1.22
2-6S	9,6	0.38	1/8-27	9/16-18	31,5	1.24
2-8S	12,7	0.50	1/8-27	3/4-16	34,0	1.34
4-4S	6,3	0.25	1/4-18	7/16-20	36,1	1.42
4-5S	7,9	0.31	1/4-18	1/2-20	36,1	1.42
4-6S	9,6	0.38	1/4-18	9/16-18	36,3	1.43
4-8S	12,7	0.50	1/4-18	3/4-16	38,9	1.53
6-4S	6,3	0.25	3/8-18	7/16-20	36,1	1.42
6-5S	7,9	0.31	3/8-18	1/2-20	36,1	1.42
6-6S	9,6	0.38	3/8-18	9/16-18	36,3	1.43
6-8S	12,7	0.50	3/8-18	3/4-16	38,9	1.53
6-10S	16,0	0.63	3/8-18	7/8-14	43,2	1.70
8-4S	6,3	0.25	1/2-14	7/16-20	42,7	1.68
8-6S	9,6	0.38	1/2-14	9/16-18	42,9	1.69
8-8S	12,7	0.50	1/2-14	3/4-16	45,5	1.79
8-10S	16,0	0.63	1/2-14	7/8-14	48,0	1.89
8-12S	19,0	0.75	1/2-14	11/16-12	52,3	2.06
12-6S	9,6	0.38	3/4-14	9/16-18	44,4	1.75
12-8S	12,7	0.50	3/4-14	3/4-16	47,0	1.85
12-10S	16,0	0.63	3/4-14	7/8-14	49,5	1.95
12-12S	19,0	0.75	3/4-14	11/16-12	52,3	2.06
12-16S	25,4	1.00	3/4-14	5/16-12	53,6	2.11
16-12S	19,0	0.75	1-11 1/2	1 1/16-12	57,2	2.25
16-16S	25,4	1.00	1-11 1/2	1 5/16-12	58,4	2.30
16-20S	31,7	1.25	1-11 1/2	1 5/8-12	61,5	2.42
16-24S	38,1	1.50	1-11 1/2	1 7/8-12	66,5	2.62
16-32S	50,8	2.00	1-11 1/2	2 1/2-12	76,7	3.02
20-12S	19,0	0.75	1 1/4-11 1/2	1 1/16-12	59,9	2.36
20-16S	25,4	1.00	1 1/4-11 1/2	1 5/16-12	61,0	2.40
20-20S	31,7	1.25	1 1/4-11 1/2	1 5/8-12	62,2	2.45
20-24S	38,1	1.50	1 1/4-11 1/2	1 7/8-12	67,3	2.65
20-32S	50,8	2.00	1 1/4-11 1/2	2 1/2-12	77,5	3.05
24-12S	19,0	0.75	1 1/2-11 1/2	1 1/16-12	62,5	2.46
24-16S	25,4	1.00	1 1/2-11 1/2	1 5/16-12	63,7	2.51
24-20S	31,7	1.25	1 1/2-11 1/2	1 5/8-12	64,8	2.55
24-24S	38,1	1.50	1 1/2-11 1/2	1 7/8-12	68,1	2.68
24-32S	50,8	2.00	1 1/2-11 1/2	2 1/2-12	78,2	3.08
32-32S	50,8	2.00	2-11 1/2	2 1/2-12	79,0	3.11

Also available in stainless steel as part no. 259-2021.
See pg. 279 for more information.

External Pipe/ 37° Flare Bulkhead

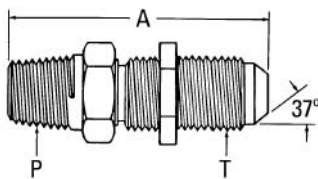

Part No. 2240-(Dash size)

Dash Size	Tube O.D.		Thread P	Thread T	A	
	mm	in			mm	in
2-4S	6,3	0.25	1/8-27	7/16-20	46,7	1.84
4-4S	6,3	0.25	1/4-18	7/16-20	51,6	2.03
4-6S	9,6	0.38	1/4-18	9/16-18	53,9	2.12
6-8S	12,7	0.50	3/8-18	3/4-16	59,9	2.36
8-10S	16,0	0.63	1/2-14	7/8-14	68,8	2.71
12-12S	19,0	0.75	3/4-14	1 1/16-12	74,2	2.92
16-16S	25,4	1.00	1-11 1/2	1 5/16-12	79,0	3.11

Also available in stainless steel as part no. 259-2240.
See pg. 279 for more information.

SPECIALTY &
TRUCK HOSE

LOW & MEDIUM
PRESSURE HOSE

HIGH PRESSURE HOSE

HOSE FITTINGS

ADAPTERS &
TUBE FITTINGS

ACCESSORIES &
ASSEMBLY INSTRUCTIONS

HOSE ASSEMBLY
EQUIPMENT

APPENDICES

External Pipe/ 37° Flare

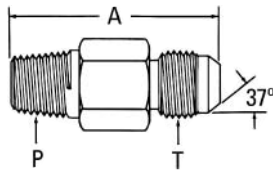

Part No. 202113-(Dash size)

Dash Size	Tube O.D.		Thread P	Thread T	A	
	mm	in			mm	in
2-4S	6,3	0.25	1/8-27	7/16-20	46,0	1.81
2-5S	7,9	0.31	1/8-27	1/2-20	49,3	1.94
4-4S	6,3	0.25	1/4-18	7/16-20	57,2	2.25
4-5S	7,9	0.31	1/4-18	1/2-20	57,2	2.25
4-6S	9,6	0.38	1/4-18	9/16-18	57,2	2.25
6-6S	9,6	0.38	3/8-18	9/16-18	63,5	2.50
6-8S	12,7	0.50	3/8-18	3/4-16	69,8	2.75
8-10S	16,0	0.63	1/2-14	7/8-14	79,2	3.12
8-12S	19,0	0.75	1/2-14	11/16-12	83,3	3.28
12-12S	19,0	0.75	3/4-14	11/16-12	88,9	3.50
16-16S	25,4	1.00	1-11 1/2	15/16-12	101,6	4.00
20-20S	38,1	1.50	1 1/4-11 1/2	1 5/8-12	114,3	4.50
24-24S	38,1	1.50	1 1/2-11 1/2	1 7/8-12	123,9	4.88
32-32S	50,8	2.00	2-11 1/2	2 1/2-12	142,7	5.62

External Pipe/ 37° Flare

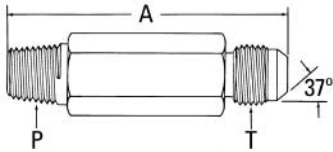

Part No. 202114-(Dash size)

Dash Size	Tube O.D.		Thread P	Thread T	A	
	mm	in			mm	in
2-4S	6,3	0.25	1/8-27	7/16-20	65,0	2.56
2-5S	7,9	0.31	1/8-27	1/2-20	71,4	2.81
4-4S	6,3	0.25	1/4-18	7/16-20	82,5	3.25
4-5S	7,9	0.31	1/4-18	1/2-20	82,5	3.25
4-6S	9,6	0.38	1/4-18	9/16-18	82,5	3.25
6-8S	12,7	0.50	3/8-18	3/4-16	101,6	4.00
8-6S	9,6	0.38	1/2-14	9/16-18	105,9	4.17
8-10S	16,0	0.63	1/2-14	7/8-14	111,2	4.38
12-12S	19,0	0.75	3/4-14	1 1/16-12	127,0	5.00
12-16S	25,4	1.00	3/4-14	1 5/16-12	141,2	5.56
16-16S	25,4	1.00	1-11 1/2	1 5/16-12	146,0	5.75

Internal Pipe/ 37° Flare Bulkhead

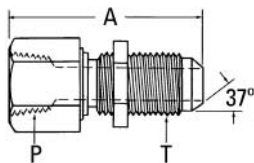

Part No. 2239-(Dash size) (Ref. SAE 070603)

Dash Size	Tube O.D.		Thread P	Thread T	A	
	mm	in			mm	in
2-4S	6,3	0.25	1/8-27	7/16-20	52,8	2.08
6-8S	12,7	0.50	3/8-18	3/4-16	63,0	2.48
8-10S	16,0	0.63	1/2-14	7/8-14	72,1	2.84
12-12S	19,0	0.75	3/4-14	1 1/16-12	77,5	3.05
16-16S	25,4	1.00	1-11 1/2	1 5/16-12	82,5	3.25

External Pipe/ 37° Flare Swivel

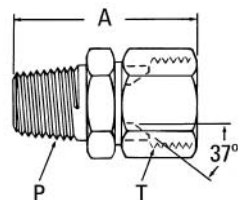

Part No. 2018-(Dash size)

Dash Size	Tube O.D.		Thread P	Thread T	A	
	mm	in			mm	in
2-4S	6,3	0.25	1/8-27	7/16-20	33,6	1.32
4-6S	9,6	0.38	1/4-18	9/16-18	40,4	1.59
6-8S	12,7	0.50	3/8-18	3/4-16	44,2	1.74
12-12S	19,0	0.75	3/4-14	1 1/16-12	54,6	2.15
16-16S	25,4	1.00	1-11 1/2	1 5/16-12	64,5	2.54
20-20S	31,7	1.25	1 1/4-11 1/2	1 5/8-12	70,6	2.78

Internal Pipe/ 37° Flare Swivel

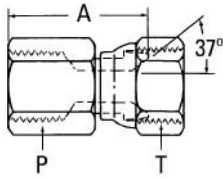

Part No. 2242-(Dash size) (Ref. SAE 070603)

Dash Size	Tube O.D.		Thread P	Thread T	A	
	mm	in			mm	in
2-4S	6,3	0.25	1/8-27	7/16-20	21,6	0.85
2-5S	7,9	0.31	1/8-27	1/2-20	22,1	0.87
4-4S	6,3	0.25	1/4-18	7/16-20	28,2	1.11
4-5S	7,9	0.31	1/4-18	1/2-20	27,9	1.10
6-6S	9,6	0.38	3/8-18	9/16-18	29,5	1.16
6-8S	12,7	0.50	3/8-18	3/4-16	30,5	1.20
8-6S	9,6	0.38	1/2-14	9/16-18	36,1	1.42
8-8S	12,7	0.50	1/2-14	3/4-16	37,6	1.48
8-10S	16,0	0.63	1/2-14	7/8-14	37,3	1.47
12-12S	19,0	0.75	3/4-14	1 1/16-12	37,8	1.49
12-14S	22,3	0.88	3/4-14	1 3/16-12	39,4	1.55
16-16S	25,4	1.00	1-11 1/2	1 5/16-12	47,0	1.85
20-20S	31,7	1.25	1 1/4-11 1/2	1 5/8-12	51,3	2.02

Internal Pipe/37° Flare

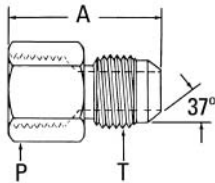

Part No. 2022-(Dash size) (Ref. SAE 070103)

Dash Size	Tube O.D.		Thread P	Thread T	A	
	mm	in			mm	in
2-3S	4,8	0.19	1/8-27	3/8-24	28,7	1.13
2-4S	6,3	0.25	1/8-27	7/16-20	30,3	1.19
2-5S	7,9	0.31	1/8-27	1/2-20	29,7	1.17
4-3S	4,8	0.19	1/4-18	3/8-24	33,6	1.32
4-4S	6,3	0.25	1/4-18	7/16-20	35,3	1.39
4-5S	7,9	0.31	1/4-18	1/2-20	35,3	1.39
4-6S	9,6	0.38	1/4-18	9/16-18	35,6	1.40
4-8S	12,7	0.50	1/4-18	3/4-16	39,4	1.55
6-6S	9,6	0.38	3/8-18	9/16-18	37,1	1.46
6-8S	12,7	0.50	3/8-18	3/4-16	39,6	1.56
8-6S	9,6	0.38	1/2-14	9/16-18	42,9	1.69
8-8S	12,7	0.50	1/2-14	3/4-16	45,5	1.79
8-10S	16,0	0.63	1/2-14	7/8-14	48,0	1.89
8-12S	19,0	0.75	1/2-14	1 1/16-12	52,0	2.05
12-8S	12,7	0.50	3/4-14	3/4-16	47,0	1.85
12-10S	16,0	0.63	3/4-14	7/8-14	49,5	1.95
12-12S	19,0	0.75	3/4-14	1 1/16-12	52,3	2.06
16-16S	25,4	1.00	1-11 1/2	1 5/16-12	59,7	2.35
20-16S	25,4	1.00	1 1/4-11 1/2	1 5/16-12	62,0	2.44
20-20S	31,7	1.25	1 1/4-11 1/2	1 5/16-12	63,2	2.49
24-24S	38,1	1.50	1 1/2-11 1/2	1 7/8-12	66,5	2.62
32-32S	50,8	2.00	2-11 1/2	2 1/2-12	75,4	2.97
40-40B	63,5	2.50	2 1/2-8	3-12	82,5	3.25

Also available in stainless steel as part no. 259-2022.
See pg. 280 for more information.

SPECIALTY &
TRUCK HOSE

LOW & MEDIUM
PRESSURE HOSE

HIGH PRESSURE HOSE

HOSE FITTINGS

ADAPTERS &
TUBE FITTINGS

ACCESSORIES &
ASSEMBLY INSTRUCTIONS

HOSE ASSEMBLY
EQUIPMENT

APPENDICES

External Pipe/ 37° Flare

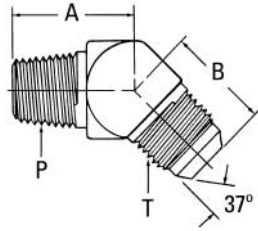

Part No. 2023-(Dash size) (Ref. SAE 070302)

Dash Size	Tube O.D.		Thread P	Thread T	A		B	
	mm	in			mm	in	mm	in
2-3S	4,8	0.19	1/8-27	3/8-24	14,7	0.58	19,3	0.76
2-4S	6,3	0.25	1/8-27	7/16-20	14,7	0.58	19,8	0.78
2-5S	7,9	0.31	1/8-27	1/2-20	16,2	0.64	20,3	0.80
2-6S	9,6	0.38	1/8-27	9/16-18	18,3	0.72	21,0	0.83
4-4S	6,3	0.25	1/4-18	7/16-20	21,8	0.86	20,8	0.82
4-5S	7,9	0.31	1/4-18	1/2-20	21,8	0.86	20,3	0.80
4-6S	9,6	0.38	1/4-18	9/16-18	21,8	0.86	21,0	0.83
4-8S	12,7	0.50	1/4-18	3/4-16	24,1	0.95	26,4	1.04
6-4S	6,3	0.25	3/8-18	7/16-20	24,1	0.95	20,1	0.79
6-6S	9,6	0.38	3/8-18	9/16-18	24,1	0.95	22,3	0.88
6-8S	12,7	0.50	3/8-18	3/4-16	24,1	0.95	24,9	0.98
6-10S	16,0	0.63	3/8-18	7/8-14	24,4	0.96	29,0	1.14
8-6S	9,6	0.38	1/2-14	9/16-18	29,7	1.17	23,1	0.91
8-8S	12,7	0.50	1/2-14	3/4-16	29,7	1.17	25,4	1.00
8-10S	16,0	0.63	1/2-14	7/8-14	29,7	1.17	28,2	1.11
8-12S	19,0	0.75	1/2-14	1 1/16-12	30,5	1.20	35,3	1.39
12-8S	12,7	0.50	3/4-14	3/4-16	30,5	1.20	27,9	1.10
12-10S	16,0	0.63	3/4-14	7/8-14	30,5	1.20	31,0	1.22
12-12S	19,0	0.75	3/4-14	1 1/16-12	30,5	1.20	32,5	1.28
12-16S	25,4	1.00	3/4-14	1 5/16-12	32,8	1.29	37,3	1.47
16-12S	19,0	0.75	1-11 1/2	1 1/16-12	37,6	1.48	38,6	1.52
16-16S	25,4	1.00	1-11 1/2	1 5/16-12	37,6	1.48	37,3	1.47
16-20S	31,7	1.25	1-11 1/2	1 5/8-12	39,1	1.54	41,1	1.62
20-20S	31,7	1.25	1 1/4-11 1/2	1 5/8-12	39,1	1.54	42,9	1.69
24-24S	38,1	1.50	1 1/2-11 1/2	1 7/8-12	44,9	1.77	45,2	1.78
32-32S	50,8	2.00	2-11 1/2	2 1/2-12	53,6	2.11	56,4	2.22
40-40	63,5	2.50	2 1/2-8	3-12	70,6	2.78	48,0	1.89

Also available in stainless steel as part no. 259-2023. See pg. 279 for more information.

Internal Pipe/ 37° Flare

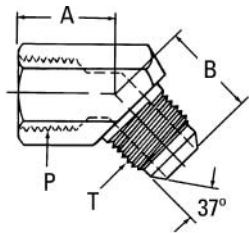

Part No. 2044-(Dash size)

Dash Size	Tube O.D.		Thread P	Thread T	A		B	
	mm	in			mm	in	mm	in
4-6S	9,6	0.38	1/4-18	9/16-18	15,7	0.62	21,0	0.83
6-8S	12,7	0.50	3/8-18	3/4-16	18,3	0.72	24,9	0.98
8-10S	16,0	0.63	1/2-14	7/8-14	23,1	0.91	28,2	1.11
12-12S	19,0	0.75	3/4-14	1 1/16-12	24,6	0.97	32,5	1.28

Internal Pipe/ 37° Flare Swivel

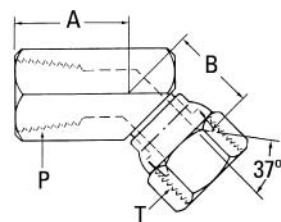

Part No. 2243-(Dash size)

Dash Size	Tube O.D.		Thread P	Thread T	A		B	
	mm	in			mm	in	mm	in
8-6S	9,6	0.38	1/2-14	9/16-18	23,1	0.91	21,3	0.84
8-10S	16,0	0.63	1/2-14	7/8-14	23,1	0.91	23,9	0.94

SPECIALTY & TRUCK HOSE
 LOW & MEDIUM PRESSURE HOSE
 HIGH PRESSURE HOSE
 HOSE FITTINGS
 ADAPTERS & TUBE FITTINGS
 ACCESSORIES & ASSEMBLY INSTRUCTIONS
 HOSE ASSEMBLY EQUIPMENT
 APPENDICES

**External Pipe/
37° Flare**

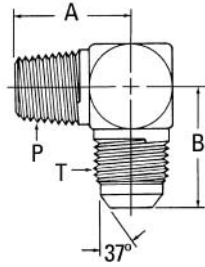

Part No. 2024-(Dash size) (Ref. SAE 070202)

Dash Size	Tube O.D.		Thread P	Thread T	A		B	
	mm	in			mm	in	mm	in
2-3S	4,8	0.19	1/8-27	3/8-24	18,3	0.72	21,0	0.83
2-4S	6,3	0.25	1/8-27	7/16-20	19,8	0.78	22,6	0.89
2-5S	7,9	0.31	1/8-27	1/2-20	19,8	0.78	24,1	0.95
2-6S	9,6	0.38	1/8-27	9/16-18	22,9	0.90	26,9	1.06
4-4S	6,3	0.25	1/4-18	7/16-20	27,7	1.09	26,7	1.05
4-5S	7,9	0.31	1/4-18	1/2-20	27,7	1.09	26,7	1.05
4-6S	9,6	0.38	1/4-18	9/16-18	27,7	1.09	26,9	1.06
4-8S	12,7	0.50	1/4-18	3/4-16	31,0	1.22	31,8	1.25
6-4S	6,3	0.25	3/8-18	7/16-20	31,0	1.22	28,5	1.12
6-5S	7,9	0.31	3/8-18	1/2-20	31,0	1.22	28,5	1.12
6-6S	9,6	0.38	3/8-18	9/16-18	31,0	1.22	29,0	1.14
6-8S	12,7	0.50	3/8-18	3/4-16	31,0	1.22	31,8	1.25
6-10S	16,0	0.63	3/8-18	7/8-14	32,5	1.28	36,8	1.45
6-12S	19,0	0.75	3/8-18	1 1/16-12	35,6	1.40	42,2	1.66
8-4S	6,3	0.25	1/2-14	7/16-20	37,3	1.47	30,7	1.21
8-6S	9,6	0.38	1/2-14	9/16-18	37,3	1.47	31,0	1.22
8-8S	12,7	0.50	1/2-14	3/8-16	37,3	1.47	33,8	1.33
8-10S	16,0	0.63	1/2-14	7/8-14	37,3	1.47	36,8	1.45
8-12S	19,0	0.75	1/2-14	1 1/16-12	40,4	1.59	42,2	1.66
8-16S	25,4	1.00	1/2-14	1 5/16-12	45,2	1.78	46,0	1.81
12-6S	9,6	0.38	3/4-14	9/16-18	40,4	1.59	33,3	1.31
12-8S	12,7	0.50	3/4-14	3/4-16	40,4	1.59	36,1	1.42
12-10S	16,0	0.63	3/4-14	7/8-14	40,4	1.59	39,1	1.54
12-12S	19,0	0.75	3/4-14	1 1/16-12	40,4	1.59	42,2	1.66
12-16S	25,4	1.00	3/4-14	1 5/16-12	45,2	1.78	46,0	1.81
16-8S	12,7	0.50	1-11 1/2	3/4-16	50,0	1.97	38,6	1.52
16-12S	19,0	0.75	1-11 1/2	1 1/16-12	50,0	1.97	44,7	1.76
16-16S	25,4	1.00	1-11 1/2	1 5/16-12	50,0	1.97	46,0	1.81
16-20S	31,7	1.25	1-11 1/2	1 5/8-12	59,7	2.35	52,3	2.06
20-16S	25,4	1.00	1 1/4-11 1/2	1 5/16-12	60,4	2.38	51,1	2.01
20-20S	31,7	1.25	1 1/4-11 1/2	1 5/8-12	60,4	2.38	52,3	2.06
20-24S	38,1	1.50	1 1/4-11 1/2	1 7/8-12	66,3	2.61	59,2	2.33
24-20S	31,7	1.25	1 1/2-11 1/2	1 5/8-12	67,0	2.64	55,9	2.20
24-24S	38,1	1.50	1 1/2-11 1/2	1 7/8-12	67,0	2.64	59,2	2.33
24-32S	50,8	2.00	1 1/2-11 1/2	1 1/2-12	75,4	2.97	77,7	3.06
32-32S	50,8	2.00	2-11 1/2	2 1/2-12	76,2	3.00	77,7	3.06
40-40S	63,5	2.50	2 1/2-8	3-12	86,1	3.39	75,7	2.98

Also available in stainless steel as part no. 259-2024. See pg. 280 for more information.

Extra Pipe/37° Flare

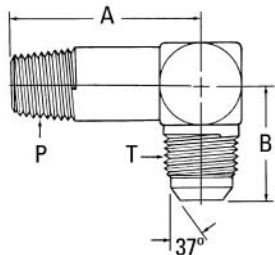

Part No. 202411-(Dash size) (Ref. SAE 071502)

Dash Size	Tube O.D.		Thread P	Thread T	A		B	
	mm	in			mm	in	mm	in
2-4S	6,3	0.25	1/8-27	7/16-20	29,7	1.17	22,6	0.89
2-5S	7,9	0.31	1/8-27	1/2-20	29,7	1.17	24,1	0.95
4-4S	6,3	0.25	1/4-18	7/16-20	40,1	1.58	26,7	1.05
4-6S	9,6	0.38	1/4-18	9/16-18	40,1	1.58	26,9	1.06
6-8S	12,7	0.50	3/8-18	3/4-16	46,2	1.82	31,8	1.25
8-8S	12,7	0.50	1/2-14	3/4-16	55,2	2.17	33,8	1.33
8-10S	16,0	0.63	1/2-14	7/8-14	55,2	2.17	36,8	1.45
12-10S	16,0	0.63	3/4-14	7/8-14	62,0	2.44	39,1	1.54
12-12S	19,0	0.75	3/4-14	1 1/16-12	62,0	2.44	42,2	1.66
12-16S	25,4	1.00	3/4-14	1 5/16-12	71,6	2.82	46,0	1.81
16-16S	25,4	1.00	1-11 1/2	1 5/16-12	76,4	3.01	46,0	1.81
20-20S	31,7	1.25	1 1/4-11 1/2	1 5/8-12	91,2	3.59	52,3	2.06

Long External Pipe/37° Flare

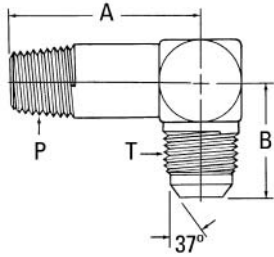

Part No. 202413-(Dash size) (Ref. SAE 071602)

Dash Size	Tube O.D.		Thread P	Thread T	A		B	
	mm	in			mm	in	mm	in
2-4S	6,3	0.25	1/8-27	7/16-20	39,6	1.56	22,6	0.89
2-5S	7,9	0.31	1/8-27	1/2-20	41,4	1.63	24,1	0.95
4-4S	6,3	0.25	1/4-18	7/16-20	52,6	2.07	26,7	1.05
4-5S	7,9	0.31	1/4-18	1/2-20	52,6	2.07	26,7	1.05
4-6S	9,6	0.38	1/4-18	9/16-18	52,6	2.07	26,9	1.06
6-6S	9,6	0.38	3/8-18	9/16-18	62,5	2.46	26,9	1.06
6-8S	12,7	0.50	3/8-18	3/4-16	61,5	2.42	31,8	1.25
8-8S	12,7	0.50	1/2-14	3/4-16	72,9	2.87	33,8	1.33
8-10S	16,0	0.63	1/2-14	7/8-14	72,9	2.87	36,8	1.45
8-12S	19,0	0.75	1/2-14	1 1/16-12	83,3	3.28	42,2	1.66
12-12S	19,0	0.75	3/4-14	1 1/16-12	83,3	3.28	42,2	1.66
12-16S	25,4	1.00	3/4-14	1 5/16-12	98,0	3.86	46,0	1.81
12-20S	31,7	1.25	3/4-14	1 5/8-12	91,7	3.61	52,3	2.06
16-16S	25,4	1.00	1-11 1/2	1 5/16-12	102,9	4.05	46,0	1.81
20-20S	31,7	1.25	1 1/4-11 1/2	1 5/8-12	122,9	4.84	52,3	2.06

Extra Long External Pipe/37° Flare

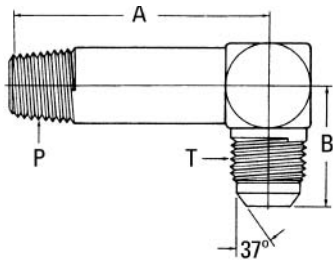

Part No. 202414-(Dash size)

Dash Size	Tube O.D.		Thread P	Thread T	A		B	
	mm	in			mm	in	mm	in
2-4S	6,3	0.25	1/8-27	7/16-20	58,7	2.31	22,6	0.89
2-5S	7,9	0.31	1/8-27	1/2-20	59,2	2.33	24,1	0.95
4-4S	6,3	0.25	1/4-18	7/16-20	75,9	2.99	24,6	0.97
4-6S	9,6	0.38	1/4-18	9/16-18	77,7	3.06	26,9	1.06
6-8S	12,7	0.50	3/8-18	3/4-16	95,2	3.75	31,8	1.25
8-8S	12,7	0.50	1/2-14	3/4-16	114,5	4.51	31,8	1.25
8-10S	16,0	0.63	1/2-14	7/8-14	114,5	4.51	36,8	1.45
12-12S	19,0	0.75	3/4-14	1 1/16-12	127,8	5.03	42,2	1.66
16-16S	25,4	1.00	1-11 1/2	1 5/16-12	161,8	6.37	46,0	1.81
20-20S	31,7	1.25	1 1/4-11 1/2	1 5/8-12	188,4	7.34	52,3	2.06

External Pipe/37° Flare Swivel

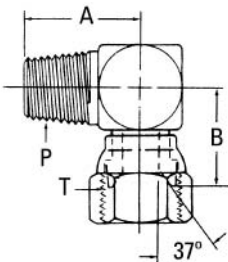

Part No. 2250-(Dash size)

Dash Size	Tube O.D.		Thread P	Thread T	A		B	
	mm	in			mm	in	mm	in
2-4S	6,3	0.25	1/8-27	7/16-20	19,8	0.78	16,8	0.66
2-5S	7,9	0.31	1/8-27	1/2-20	19,8	0.78	17,3	0.68
4-6S	9,6	0.38	1/4-18	9/16-18	27,7	1.09	22,3	0.88
6-6S	9,6	0.38	3/8-18	9/16-18	31,0	1.22	21,6	0.85
6-8S	12,7	0.50	3/8-18	3/4-16	31,0	1.22	24,4	0.96
8-8S	12,7	0.50	1/2-14	3/4-16	37,3	1.47	25,4	1.00
8-10S	16,0	0.63	1/2-14	7/8-14	37,3	1.47	28,5	1.12
12-8S	12,7	0.50	3/4-14	3/4-16	40,4	1.59	29,7	1.17
12-12S	19,0	0.75	3/4-14	1 1/16-12	40,4	1.59	30,3	1.19
12-14S	22,3	0.88	3/4-14	1 3/16-12	42,9	1.69	30,5	1.20
16-16S	25,4	1.00	1-11 1/2	1 5/16-12	50,0	1.97	35,8	1.41
20-20S	31,7	1.25	1 1/4-11 1/2	1 5/8-12	60,4	2.38	42,7	1.68
24-24S	38,1	1.50	1 1/2-11 1/2	1 7/8-12	67,0	2.64	47,2	1.86

SPECIALTY & TRUCK HOSE
 LOW & MEDIUM PRESSURE HOSE
 HIGH PRESSURE HOSE
 HOSE FITTINGS
 ADAPTERS & TUBE FITTINGS
 ACCESSORIES & ASSEMBLY INSTRUCTIONS
 HOSE ASSEMBLY EQUIPMENT
 APPENDICES

External Pipe Swivel/37° Flare

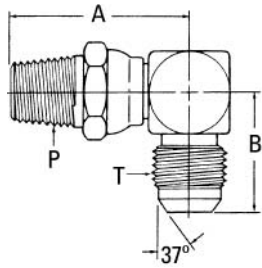

Internal Pipe/ 37° Flare Swivel

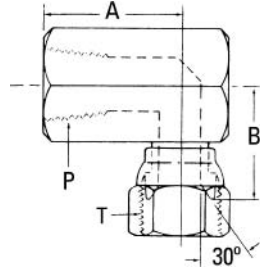

External Pipe/ 37° Flare

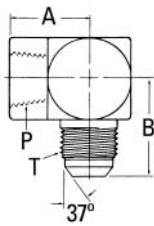

External Pipe/37° Flare

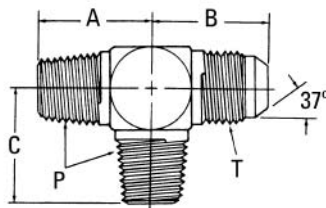

Part No. 2249-(Dash size)

Dash Size	Tube O.D.		Thread P	Thread T	A		B	
	mm	in			mm	in	mm	in
4-6S	9,6	0.38	1/4-18	9/16-18	40,6	1.60	26,9	1.06
6-8S	12,7	0.50	3/8-18	3/4-16	43,4	1.71	31,0	1.22
8-10S	16,0	0.63	1/2-14	7/8-14	50,8	2.00	36,8	1.45
12-12S	19,0	0.75	3/4-14	1 1/16-12	41,1	1.62	42,2	1.66

NOTE: The above adapter is not a rotating union or swivel joint. Care must be exercised to avoid misuse. To be used with petroleum or water glycol fluids.

Part No. 2244-(Dash size)

Dash Size	Tube O.D.		Thread P	Thread T	A		B	
	mm	in			mm	in	mm	in
6-6S	9,6	0.38	3/8-18	9/16-18	25,9	1.02	23,4	0.92
8-6S	9,6	0.38	1/2-14	9/16-18	31,2	1.23	26,2	1.03
8-8S	12,7	0.50	1/2-14	3/4-16	31,2	1.23	27,4	1.08
8-10S	16,0	0.63	1/2-14	7/8-14	31,2	1.23	28,5	1.12

Part No. 2025-(Dash size) (Ref. SAE 070203)

Dash Size	Tube O.D.		Thread P	Thread T	A		B	
	mm	in			mm	in	mm	in
2-4S	6,3	0.25	1/8-27	7/16-20	16,8	0.66	27,4	1.08
2-5S	7,9	0.31	1/8-27	1/2-20	16,8	0.66	27,4	1.08
2-6S	9,6	0.38	1/8-27	9/16-18	17,0	0.67	31,2	1.23
4-4S	6,3	0.25	1/4-18	7/16-20	22,3	0.88	31,0	1.22
4-5S	7,9	0.31	1/4-18	1/2-20	22,3	0.88	31,0	1.22
4-6S	9,6	0.38	1/4-18	9/16-18	22,3	0.88	31,2	1.23
4-8S	12,7	0.50	1/4-18	3/4-16	25,7	1.01	36,1	1.42
6-4S	6,3	0.25	3/8-18	7/16-20	25,9	1.02	32,8	1.29
6-5S	7,9	0.31	3/8-18	1/2-20	25,9	1.02	32,8	1.29
6-6S	9,6	0.38	3/8-18	9/16-18	25,9	1.02	33,3	1.31
6-8S	12,7	0.50	3/8-18	3/4-16	25,9	1.02	36,1	1.42
8-4S	6,3	0.25	1/2-14	7/16-20	31,2	1.23	35,6	1.40
8-5S	7,9	0.31	1/2-14	1/2-20	31,2	1.23	35,6	1.40
8-8S	12,7	0.50	1/2-14	3/4-16	31,2	1.23	38,6	1.52
8-10S	16,0	0.63	1/2-14	7/8-14	31,2	1.23	41,6	1.64
8-12S	19,0	0.75	1/2-14	1 1/16-12	34,3	1.35	48,0	1.89
12-12S	19,0	0.75	3/4-14	1 1/16-12	34,5	1.36	48,0	1.89
16-16S	25,4	1.00	1-11 1/2	1 5/16-12	41,1	1.62	55,2	2.17
20-20S	31,7	1.25	1 1/4-11 1/2	1 5/8-12	43,2	1.70	59,2	2.33
24-24S	38,1	1.50	1 1/2-11 1/2	1 7/8-12	52,8	2.08	73,4	2.89
32-32S	50,8	2.00	2-11 1/2	2 1/2-12	60,7	2.39	83,8	3.30

Part No. 203007-(Dash size)

Dash Size	Tube O.D.		Thread P	Thread T	A		B		C	
	mm	in			mm	in	mm	in	mm	in
2-4S	6,3	0.25	1/8-27	7/16-20	19,8	0.78	22,6	0.89	19,8	0.78
4-6S	9,6	0.38	1/4-18	9/16-18	27,7	1.09	26,9	1.06	27,7	1.09
6-8S	12,7	0.50	3/8-18	3/4-16	31,0	1.22	31,8	1.25	31,0	1.22
8-10S	16,0	0.63	1/2-14	7/8-14	37,3	1.47	36,8	1.45	37,3	1.47
12-12S	19,0	0.75	3/4-14	1 1/16-12	40,4	1.59	42,2	1.66	40,4	1.59
16-16S	25,4	1.00	1-11 1/2	1 5/16-12	50,0	1.97	46,0	1.81	50,0	1.97
20-20S	31,7	1.25	1 1/4-11 1/2	1 5/8-12	61,0	2.40	55,9	2.20	60,4	2.38
24-24S	38,1	1.50	1 1/2-11 1/2	1 7/8-12	67,6	2.66	61,5	2.42	67,0	2.64

SPECIALTY & TRUCK HOSE

LOW & MEDIUM PRESSURE HOSE

HIGH PRESSURE HOSE

HOSE FITTINGS

ADAPTERS & TUBE FITTINGS

ACCESSORIES & ASSEMBLY INSTRUCTIONS

HOSE ASSEMBLY EQUIPMENT

APPENDICES

External Pipe/ Internal Pipe/37° Flare

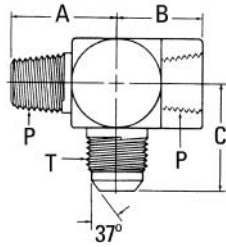

Part No. 203301-(Dash size)

Dash Size	Tube O.D.		Thread P	Thread T	A		B		C	
	mm	in			mm	in	mm	in	mm	in
2-4S	6,3	0.25	1/8-27	7/16-20	19,8	0.78	16,8	0.66	27,4	1.08
4-6S	9,6	0.38	1/4-18	9/16-18	27,7	1.09	22,3	0.88	31,2	1.23
6-8S	12,7	0.50	3/8-18	3/4-16	31,0	1.22	25,9	1.02	36,1	1.42
8-10S	16,0	0.63	1/2-14	7/8-14	37,3	1.47	31,2	1.23	41,6	1.64
12-12S	19,0	0.75	3/4-14	1 1/16-12	40,4	1.59	34,5	1.36	48,0	1.89
16-16S	25,4	1.00	1-11 1/2	1 5/16-12	50,0	1.97	41,1	1.62	55,2	2.17

External Pipe/ 37° Flare/Internal Pipe

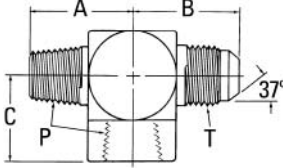

Part No. 203103-(Dash size)

Dash Size	Tube O.D.		Thread P	Thread T	A		B		C	
	mm	in			mm	in	mm	in	mm	in
2-4S	6,3	0.25	1/8-27	7/16-20	19,8	0.78	27,4	1.08	16,8	0.66
4-6S	9,6	0.38	1/4-18	9/16-18	27,7	1.09	31,2	1.23	22,3	0.88
6-6S	9,6	0.38	3/8-18	9/16-18	31,0	1.22	33,3	1.31	25,9	1.02
6-8S	12,7	0.50	3/8-18	3/4-16	31,0	1.22	36,1	1.42	25,9	1.02
8-10S	16,0	0.63	1/2-14	7/8-14	37,3	1.47	41,6	1.64	31,2	1.23
12-12S	19,0	0.75	3/4-14	1 1/16-12	40,4	1.59	48,0	1.89	34,5	1.36
16-16S	25,4	1.00	1-11 1/2	1 5/16-12	53,1	2.09	53,1	2.09	42,1	1.62
20-20S	31,7	1.25	1 1/4-11 1/2	1 5/8-12	65,3	2.57	60,4	2.38	43,2	1.70
32-32S	50,8	2.00	2-11 1/2	2 1/2-12	79,7	3.14	83,8	3.30	60,7	2.39

External Pipe/ 37° Flare

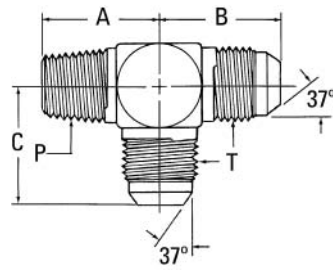

Part No. 2028-(Dash size) (Ref. SAE 070424)

Dash Size	Tube O.D.		Thread P	Thread T	A		B		C	
	mm	in			mm	in	mm	in	mm	in
2-3S	4,8	0.19	1/8-27	3/8-24	18,3	0.72	21,1	0.83	21,1	0.83
2-4S	6,3	0.25	1/8-27	7/16-20	19,8	0.78	22,6	0.89	22,6	0.89
2-5S	7,9	0.31	1/8-27	1/2-20	20,8	0.82	23,4	0.96	24,1	0.95
4-4S	6,3	0.25	1/4-18	7/16-20	27,7	1.09	26,7	1.05	26,7	1.05
4-5S	7,9	0.31	1/4-18	1/2-20	27,7	1.09	26,7	1.05	26,7	1.05
4-6S	9,6	0.38	1/4-18	9/16-18	27,7	1.09	26,9	1.06	26,9	1.06
6-6S	9,6	0.38	3/8-18	9/16-18	31,0	1.22	28,9	1.14	28,9	1.14
6-8S	12,7	0.50	3/8-18	3/4-16	31,0	1.22	31,7	1.25	31,7	1.25
8-8S	12,7	0.50	1/2-14	3/4-16	37,3	1.47	28,9	1.33	28,9	1.33
8-10S	16,0	0.63	1/2-14	7/8-14	37,3	1.47	36,8	1.45	36,8	1.45
8-12S	19,0	0.75	1/2-14	1 1/16-12	40,4	1.59	42,2	1.66	42,2	1.66
12-10S	16,0	0.63	3/4-14	7/8-14	40,4	1.59	39,1	1.54	39,1	1.54
12-12S	19,0	0.75	3/4-14	1 1/16-12	40,4	1.59	42,2	1.66	42,2	1.66
16-16S	25,4	1.00	1-11 1/2	1 5/16-12	50,0	1.97	46,0	1.81	46,0	1.81
20-20S	31,7	1.25	1 1/4-11 1/2	1 5/8-12	60,4	2.38	55,6	2.19	52,3	2.06
24-24S	38,1	1.50	1 1/2-11 1/2	1 7/8-12	67,0	2.64	61,0	2.40	59,2	2.33
32-32S	50,8	2.00	2-11 1/2	2 1/2-12	76,2	3.00	80,0	3.15	77,7	3.06

External Pipe/ Internal Pipe/37° Flare

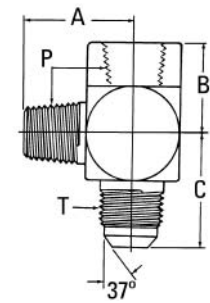

Part No. 203006-(Dash size)

Dash Size	Tube O.D.		Thread P	Thread T	A		B		C	
	mm	in			mm	in	mm	in	mm	in
2-4S	6,3	.25	1/8-27	7/16-20	19,8	0.78	16,8	0.66	27,4	1.08
4-6S	9,6	.38	1/4-18	9/16-18	27,7	1.09	22,3	0.88	31,2	1.23
6-8S	12,7	.50	3/8-18	3/4-16	31,0	1.22	25,9	1.02	36,1	1.42
8-10S	16,0	.63	1/2-14	7/8-14	37,3	1.47	31,2	1.23	41,6	1.64
12-12S	19,0	0.75	3/4-14	1 1/16-12	40,4	1.59	34,5	1.36	48,0	1.89
16-16S	25,4	1.00	1-11 1/2	1 5/16-12	50,0	1.97	42,1	1.62	55,1	2.17
20-20S	31,7	1.25	1 1/4-11 1/2	1 5/8-12	60,4	2.38	43,2	1.70	59,2	2.33

SPECIALTY & TRUCK HOSE
LOW & MEDIUM PRESSURE HOSE
HIGH PRESSURE HOSE
HOSE FITTINGS
ADAPTERS & TUBE FITTINGS
ACCESSORIES & ASSEMBLY INSTRUCTIONS
HOSE ASSEMBLY EQUIPMENT
APPENDICES

**External Pipe/
37° Flare**

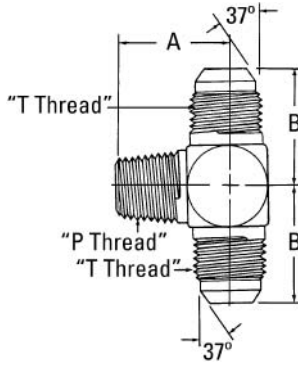

Part No. 2030-(Dash size) (Ref. SAE 070425)

Dash Size	Tube O.D.		Thread P	Thread T	A		B	
	mm	in			mm	in	mm	in
2-3S	4,8	0.19	1/8-27	3/8-24	18,3	0.72	21,1	0.83
2-4S	6,3	0.25	1/8-27	7/16-20	19,8	0.78	22,6	0.89
2-5S	7,9	0.31	1/8-27	1/2-20	20,3	0.80	24,1	0.95
4-4S	6,3	0.25	1/4-18	7/16-20	27,7	1.09	26,7	1.05
4-5S	7,9	0.31	1/4-18	1/2-20	27,7	1.09	26,7	1.05
4-6S	9,6	0.38	1/4-18	9/16-18	27,7	1.09	26,9	1.06
6-6S	9,6	0.38	3/8-18	9/16-18	31,0	1.22	26,9	1.06
6-8S	12,7	0.50	3/8-18	3/4-16	31,0	1.22	31,7	1.25
6-10S	16,0	0.63	3/8-18	7/8-14	31,7	1.25	36,8	1.45
8-6S	9,6	0.38	1/2-14	9/16-18	37,3	1.47	28,7	1.13
8-8S	12,7	0.50	1/2-14	3/4-16	37,3	1.47	28,9	1.33
8-10S	16,0	0.63	1/2-14	7/8-14	37,3	1.47	36,8	1.45
12-12S	19,0	0.75	3/4-14	1 1/16-12	40,4	1.59	42,2	1.66
12-16S	25,4	1.00	3/4-14	1 5/16-12	45,2	1.78	46,0	1.81
16-16S	25,4	1.00	1-11 1/2	1 5/16-12	50,0	1.97	46,0	1.81
20-20S	31,7	1.25	1 1/4-11 1/2	1 5/8-12	60,4	2.38	55,9	2.20

Internal Pipe/37° Flare

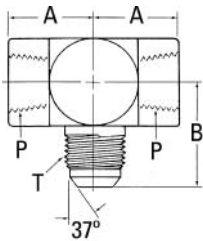

Part No. 202901-(Dash size)

Dash Size	Tube O.D.		Thread P	Thread T	A		B	
	mm	in			mm	in	mm	in
2-4S	6,3	0.25	1/8-27	7/16-20	16,8	0.66	27,4	1.08
4-6S	9,6	0.38	1/4-18	9/16-18	22,3	0.88	31,2	1.23
12-12S	19,0	0.75	3/4-14	1 1/16-12	34,5	1.36	48,0	1.89
16-16S	25,4	1.00	1-11 1/2	1 5/16-12	42,1	1.62	55,1	2.17

**Internal Pipe/
Internal Pipe/37° Flare**

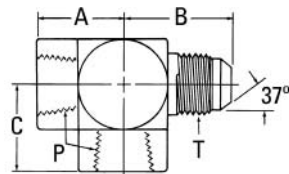

Part No. 203104-(Dash size) (Ref. SAE 070427)

Dash Size	Tube O.D.		Thread P	Thread T	A		B		C	
	mm	in			mm	in	mm	in	mm	in
2-2S	3,3	0.13	1/8-27	5/16-24	16,8	0.66	25,4	1.00	16,5	0.65
2-4S	6,3	0.25	1/8-27	7/16-20	16,8	0.66	27,4	1.08	16,8	0.66
4-6S	9,6	0.38	1/4-18	9/16-18	22,3	0.88	31,2	1.23	22,3	0.88
8-10S	16,0	0.63	1/2-14	7/8-14	31,2	1.23	41,6	1.64	31,2	1.23
16-16S	25,4	1.00	1-11 1/2	1 5/16-12	42,1	1.62	55,1	2.17	42,1	1.62
20-20S	31,7	1.25	1 1/4-11 1/2	1 5/8-12	43,2	1.70	59,2	2.33	43,2	1.70
24-24S	38,1	1.50	1 1/2-11 1/2	1 7/8-12	52,8	2.08	73,4	2.89	52,8	2.08

SPECIALTY & TRUCK HOSE

LOW & MEDIUM PRESSURE HOSE

HIGH PRESSURE HOSE

HOSE FITTINGS

ADAPTERS & TUBE FITTINGS

ACCESSORIES & ASSEMBLY INSTRUCTIONS

HOSE ASSEMBLY EQUIPMENT

APPENDICIES

Internal Pipe/37° Flare

Part No. 2029-(Dash size) (Ref. SAE 070426)

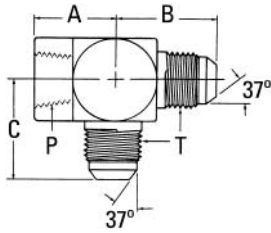

Dash Size	Tube O.D.		Thread P	Thread T	A		B		C	
	mm	in			mm	in	mm	in	mm	in
2-4S	6,3	0.25	1/8-27	7/16-20	16,8	0.66	27,4	1.08	24,1	0.95
2-5S	7,9	0.31	1/8-27	1/2-20	16,8	0.66	27,4	1.08	24,9	0.98
4-4S	6,3	0.25	1/4-18	7/16-20	22,4	0.88	25,4	1.00	25,4	1.00
4-6S	9,6	0.38	1/4-18	9/16-18	22,6	0.89	31,2	1.23	28,2	1.11
6-8S	12,7	0.50	3/8-18	3/4-16	25,9	1.02	36,1	1.42	33,6	1.32
8-8S	12,7	0.50	1/2-14	3/4-16	31,2	1.23	36,1	1.42	35,6	1.40
8-10S	16,0	0.63	1/2-14	7/8-14	31,2	1.23	41,6	1.64	41,6	1.64
12-12S	19,0	0.75	3/4-14	1 1/16-12	34,5	1.36	48,0	1.89	48,0	1.89
16-16S	25,4	1.00	1-11 1/2	1 5/16-12	41,1	1.62	55,2	2.17	53,1	2.09
20-20S	31,7	1.25	1 1/4-11 1/2	1 5/8-12	43,2	1.70	59,2	2.33	60,7	2.39
24-24S	38,1	1.50	1 1/2-11 1/2	1 7/8-12	52,8	2.08	73,4	2.89	66,3	2.61

Internal Pipe/37° Flare Swivel

Part No. 2031-(Dash size) (Ref. SAE 070427)

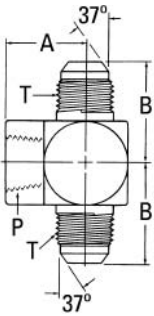

Dash Size	Tube O.D.		Thread P	Thread T	A		B	
	mm	in			mm	in	mm	in
2-3S	4,8	0.19	1/8-27	3/8-24	16,8	0.66	26,2	1.03
2-4S	6,3	0.25	1/8-27	7/16-20	16,8	0.66	27,4	1.08
2-5S	7,9	0.31	1/8-27	1/2-20	16,8	0.66	27,4	1.08
4-4S	6,3	0.25	1/4-18	7/16-20	22,4	0.88	31,0	1.22
4-6S	9,6	0.38	1/4-18	9/16-18	22,4	0.88	31,2	1.23
6-8S	12,7	0.50	3/8-18	3/4-16	25,9	1.02	36,1	1.42
8-10S	16,0	0.63	1/2-14	7/8-14	31,2	1.23	41,6	1.64
12-12S	19,0	0.75	3/4-14	1 1/16-12	34,5	1.36	48,0	1.89
16-16S	25,4	1.00	1-11 1/2	1 5/16-12	41,1	1.62	53,1	2.09
20-20S	31,7	1.25	1 1/4-11 1/2	1 5/8-12	43,2	1.70	60,4	2.38
24-24S	38,1	1.50	1 1/2-11 1/2	1 7/8-12	52,8	2.08	65,5	2.58
32-32S	50,8	2.00	2-11 1/2	2 1/2-12	60,7	2.39	83,8	3.30

External Pipe/37° Flare

Part No. 202003-(Dash size)

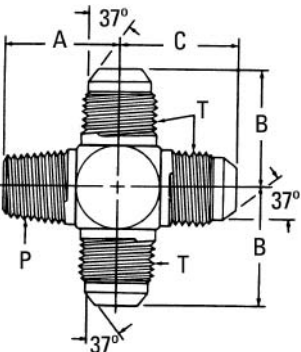

Dash Size	Tube O.D.		Thread P	Thread T	A		B		C	
	mm	in			mm	in	mm	in	mm	in
6-6S	9,6	0.38	3/8-18	9/16-18	26,9	1.06	26,9	1.06	26,9	1.06
12-12S	19,0	0.75	3/4-14	1 1/16-12	40,4	1.59	42,2	1.66	44,2	1.74

Internal Pipe/37° Flare

Part No. 202006-(Dash size)

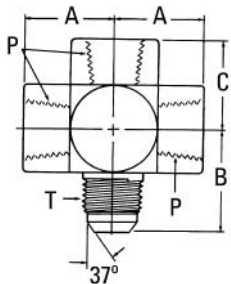

Dash Size	Tube O.D.		Thread P	Thread T	A		B		C	
	mm	in			mm	in	mm	in	mm	in
8-10S	16,0	0.63	1/2-14	7/8-14	29,7	1.17	41,6	1.64	31,2	1.23
12-12S	19,0	0.75	3/4-14	1 1/16-12	34,5	1.36	48,0	1.89	34,5	1.36
20-20S	31,7	1.25	1 1/4-11 1/2	1 5/8-12	43,2	1.70	59,2	2.33	43,2	1.70
24-24S	38,1	1.50	1 1/2-11 1/2	1 7/8-12	52,8	2.08	73,4	2.89	52,8	2.08

Pipe to 45° Flare

External Pipe/45° Flare Part No. 2000-(Dash size) (Ref. SAE 010102)

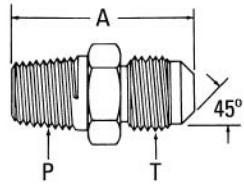

Dash Size	Tube O.D.		Thread P	Thread T	A	
	mm	in			mm	in
2-4B	6,3	0.25	1/8-27	7/16-20	26,9	1.06
2-5B	7,9	0.31	1/8-27	1/2-20	29,5	1.16
2-6B	9,6	0.38	1/8-27	5/8-18	31,8	1.25
4-4B	6,3	0.25	1/4-18	7/16-20	31,8	1.25
4-5B	7,9	0.31	1/4-18	1/2-20	34,0	1.34
4-6B	9,6	0.38	1/4-18	5/8-18	36,6	1.44
4-8B	12,7	0.50	1/4-18	3/4-16	41,1	1.62
4-10B	16,0	0.63	1/4-18	7/8-14	46,0	1.81
6-4B	6,3	0.25	3/8-18	7/16-20	33,3	1.31
6-5B	7,9	0.31	3/8-18	1/2-20	35,1	1.38
6-6B	9,6	0.38	3/8-18	5/8-18	36,6	1.44
6-8B	12,7	0.50	3/8-18	3/4-16	41,1	1.62
6-10B	16,0	0.63	3/8-18	7/8-14	46,0	1.81
8-4B	6,3	0.25	1/2-14	7/16-20	39,6	1.56
8-6B	9,6	0.38	1/2-14	5/8-18	42,9	1.69
8-8B	12,7	0.50	1/2-14	3/4-16	46,0	1.81
8-10B	16,0	0.63	1/2-14	7/8-14	50,8	2.00
8-12B	19,0	0.75	1/2-14	1 1/16-14	55,6	2.19
12-8B	12,7	0.50	3/4-14	3/4-16	49,3	1.94
12-10B	16,0	0.63	3/4-14	7/8-14	52,3	2.06
12-12B	19,0	0.75	3/4-14	1 1/16-14	55,6	2.19

Internal Pipe/45° Flare Part No. 2001-(Dash size) (Ref. SAE 010103)

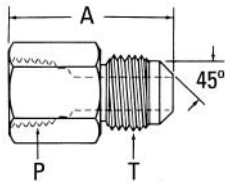

Dash Size	Tube O.D.		Thread P	Thread T	A	
	mm	in			mm	in
2-4B	6,3	0.25	1/8-27	7/16-20	26,9	1.06
2-5B	7,9	0.31	1/8-27	1/2-20	29,5	1.16
4-4B	6,3	0.25	1/4-18	7/16-20	30,3	1.19
4-5B	7,9	0.31	1/4-18	1/2-20	31,8	1.25
4-6B	9,6	0.38	1/4-18	5/8-18	33,3	1.31
4-8B	12,7	0.50	1/4-18	3/4-16	36,6	1.44
6-4B	6,3	0.25	3/8-18	7/16-20	30,3	1.19
6-6B	9,6	0.38	3/8-18	5/8-18	33,3	1.31
6-8B	12,7	0.50	3/8-18	3/4-16	39,6	1.56
6-10B	16,0	0.63	3/8-18	7/8-14	39,6	1.56
8-6B	9,6	0.38	1/2-14	5/8-18	38,1	1.50
8-8B	12,7	0.50	1/2-14	3/4-16	41,1	1.62
8-10B	16,0	0.63	1/2-14	7/8-14	46,0	1.81
8-12B	19,0	0.75	1/2-14	1 1/16-12	50,8	2.00
12-10B	16,0	0.63	3/4-14	7/8-14	46,0	1.81
12-12B	19,0	0.75	3/4-14	1 1/16-14	49,3	1.94

External Pipe/45° Flare Part No. 2007-(Dash size) (Ref. SAE 010302)

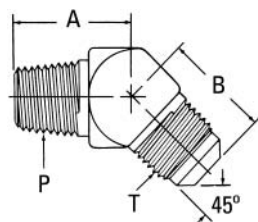

Dash Size	Tube O.D.		Thread P	Thread T	A		B	
	mm	in			mm	in	mm	in
2-4B	6,3	0.25	1/8-27	7/16-20	16,2	0.64	17,3	0.68
4-4B	6,3	0.25	1/4-18	7/16-20	21,8	0.86	19,0	0.75
4-6B	9,6	0.38	1/4-18	5/8-18	21,8	0.86	23,1	0.91
6-6B	9,6	0.38	3/8-18	5/8-18	23,9	0.94	23,6	0.93
6-8B	12,7	0.50	3/8-18	3/4-16	22,4	0.88	27,2	1.07
8-6B	9,6	0.38	1/2-14	5/8-18	29,7	1.17	25,1	0.99
8-8B	12,7	0.50	1/2-14	3/4-16	30,0	1.18	28,5	1.12
8-10B	16,0	0.63	1/2-14	7/8-14	29,7	1.17	28,5	1.12

External Pipe/45° Flare Part No. 2003-(Dash size) (Ref. SAE 010202)

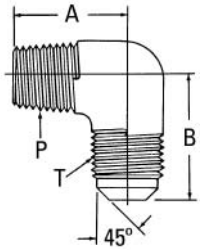

Dash Size	Tube O.D.		Thread P	Thread T	A		B	
	mm	in			mm	in	mm	in
2-4B	6,3	0.25	1/8-27	7/16-20	20,1	0.79	21,3	0.84
2-5B	7,9	0.31	1/8-27	1/2-20	19,8	0.78	23,1	0.91
2-6B	9,6	0.38	1/8-27	5/8-18	22,4	0.88	25,4	1.00
4-4B	6,3	0.25	1/4-18	7/16-20	22,4	0.88	20,6	0.81
4-5B	7,9	0.31	1/4-18	1/2-20	24,4	0.96	24,9	0.98
4-6B	9,6	0.38	1/4-18	5/8-18	22,4	0.88	25,4	1.00
4-8B	12,7	0.50	1/4-18	3/4-16	25,4	1.00	30,3	1.19
6-4B	6,3	0.25	3/8-18	7/16-20	23,1	0.91	23,1	0.91
6-5B	7,9	0.31	3/8-18	1/2-20	23,1	0.91	25,4	1.00
6-6B	9,6	0.38	3/8-18	5/8-18	23,1	0.91	25,9	1.02
6-8B	12,7	0.50	3/8-18	3/4-16	25,4	1.00	30,3	1.19
6-10B	16,0	0.63	3/8-18	7/8-14	31,0	1.22	34,5	1.36
8-6B	9,6	0.38	1/2-14	5/8-18	27,7	1.09	27,9	1.10
8-8B	12,7	0.50	1/2-14	3/4-16	29,0	1.14	29,5	1.16
8-10B	16,0	0.63	1/2-14	7/8-14	31,0	1.22	34,3	1.35
8-12B	19,0	0.75	1/2-14	1 1/16-14	38,1	1.50	42,9	1.69
12-6B	9,6	0.38	3/4-14	5/8-18	30,3	1.19	33,3	1.31
12-8B	12,7	0.50	3/4-14	3/4-16	31,8	1.25	36,1	1.42
12-10B	16,0	0.63	3/4-14	7/8-14	33,3	1.31	36,3	1.43
12-12B	19,0	0.75	3/4-14	1 1/16-14	41,4	1.63	42,4	1.67

Internal Pipe/45° Flare Part No. 2002-(Dash size) (Ref. SAE 010203)

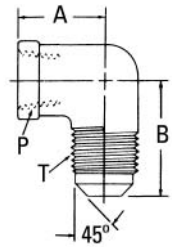

Dash Size	Tube O.D.		Thread P	Thread T	A		B	
	mm	in			mm	in	mm	in
2-4B	6,3	0.25	1/8-27	7/16-20	11,7	0.46	22,9	0.90
2-5B	7,9	0.31	1/8-27	1/2-20	15,0	0.59	25,4	1.00
4-4B	6,3	0.25	1/4-18	7/16-20	16,8	0.66	24,6	0.97
4-5B	7,9	0.31	1/4-18	1/2-20	26,9	1.06	26,9	1.06
4-6B	9,6	0.38	1/4-18	5/8-18	15,0	0.59	26,9	1.06
6-4B	6,3	0.25	3/8-18	7/16-20	14,5	0.57	26,2	1.03
6-6B	9,6	0.38	3/8-18	5/8-18	27,7	1.09	26,9	1.06
6-8B	12,7	0.50	3/8-18	3/4-16	29,0	1.14	29,5	1.16
6-10B	16,0	0.63	3/8-18	7/8-14	31,0	1.22	34,3	1.35
8-8B	12,7	0.50	1/2-14	3/4-16	23,9	0.94	35,1	1.38
8-10B	16,0	0.63	1/2-14	7/8-14	25,4	1.00	41,1	1.62
8-12B	19,0	0.75	1/2-14	1 1/16-14	26,9	1.06	41,4	1.63
12-12B	19,0	0.75	3/4-14	1 1/16-14	26,9	1.06	45,2	1.78

Pipe to SAE O-Ring

External Pipe/SAE O-Ring Boss (Internal)

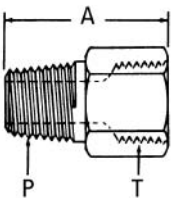

Dash Size	Thread P	Thread T	A	
			mm	in
2-4S	1/8-27	7/16-20	27,7	1.09
2-5S	1/8-27	1/2-20	27,7	1.09
4-6S	1/4-18	9/16-18	34,5	1.36
6-8S	3/8-18	3/4-16	36,8	1.45
8-10S	1/2-14	7/8-14	45,2	1.78
12-12S	3/4-14	1 1/16-12	48,8	1.92
12-14S	3/4-14	1 3/16-12	48,8	1.92
16-16S	1-11 1/2	1 5/16-12	54,1	2.13

SPECIALTY & TRUCK HOSE
 LOW & MEDIUM PRESSURE HOSE
 HIGH PRESSURE HOSE
 HOSE FITTINGS
 ADAPTERS & TUBE FITTINGS
 ACCESSORIES & ASSEMBLY INSTRUCTIONS
 HOSE ASSEMBLY EQUIPMENT
 APPENDICES

Pipe to SAE O-Ring

Internal Pipe Swivel (NPSM)/SAE O-Ring Boss

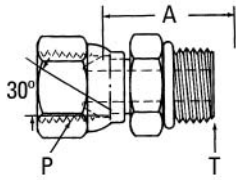

Part No. 2066-(Dash size)

Dash Size	Thread P	Thread T	A	
			mm	in
4-4S	1/4-18	7/16-20	26,7	1.05
4-6S	1/4-18	9/16-18	29,0	1.14
6-6S	3/8-18	9/16-18	29,0	1.14
6-8S	3/8-18	3/4-16	30,3	1.19
8-8S	1/2-14	3/4-16	31,2	1.23
8-10S	1/2-14	7/8-14	33,0	1.30
12-8S	3/4-14	3/4-16	37,8	1.49
12-10S	3/4-14	7/8-14	39,4	1.55
12-12S	3/4-14	1 1/16-12	40,1	1.58
12-14S	3/4-14	1 3/16-12	40,1	1.58
16-16S	1-11 1/2	1 5/16-12	40,4	1.59
16-20S	1-11 1/2	1 5/8-12	40,4	1.59

NOTE: Available without O-ring.
Order by Part No. 206604-(Dash size).

Internal Pipe/SAE O-Ring Boss

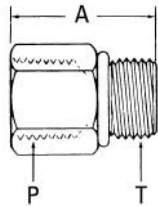

Part No. 2216-(Dash size)

Dash Size	Thread P	Thread T	A	
			mm	in
2-4S	1/8-27	7/16-20	23,4	0.92
4-5S	1/4-18	1/2-20	30,5	1.20
4-6S	1/4-18	9/16-18	31,5	1.24
6-8S	3/8-18	3/4-16	31,8	1.25
6-12S	3/8-18	1 1/16-12	34,0	1.34
8-8S	1/2-14	3/4-16	41,9	1.65
8-10S	1/2-14	7/8-14	39,1	1.54
8-12S	1/2-14	1 1/16-12	43,7	1.72
12-12S	3/4-14	1 1/16-12	42,4	1.67
12-14S	3/4-14	1 3/16-12	42,7	1.68
12-16S	3/4-14	1 5/16-12	25,4	1.00
16-16S	1-11 1/2	1 5/16-12	48,5	1.91
16-20S	1-11 1/2	1 5/8-12	25,4	1.00
20-20S	1 1/2-11 1/2	1 5/8-12	50,8	2.00
24-24S	1 1/2-11 1/2	1 7/8-12	50,8	2.00
32-32S	2-11 1/2	2 1/2-12	53,3	2.10

NOTE: Available without O-ring.
Order by Part no. 2216-1-(Dash size).

Internal Pipe Swivel (NPSM)/SAE O-Ring Boss (adj.)

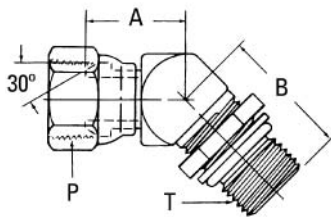

Part No. 2067-(Dash size)

Dash Size	Thread P	Thread T	A		B	
			mm	in	mm	in
6-6S	3/8-18	9/16-18	23,4	0.92	30,5	1.20
6-8S	3/8-18	3/4-16	23,4	0.92	33,8	1.33
8-8S	1/2-14	3/4-16	23,1	0.91	35,3	1.39
8-10S	1/2-14	7/8-14	23,1	0.91	39,4	1.55
12-8S	3/4-14	3/4-16	27,9	1.10	36,6	1.44
12-12S	3/4-14	1 1/16-12	27,9	1.10	44,7	1.76
12-16S	3/4-14	1 5/16-12	27,9	1.10	48,0	1.89
16-12S	1-11 1/2	1 1/16-12	32,0	1.26	48,0	1.89
16-16S	1-11 1/2	1 5/16-12	32,0	1.26	48,0	1.89

NOTE: Available without O-ring. Order by Part No. 2067-1-(Dash size).

SPECIALTY & TRUCK HOSE

LOW & MEDIUM PRESSURE HOSE

HIGH PRESSURE HOSE

HOSE FITTINGS

ADAPTERS & TUBE FITTINGS

ACCESSORIES & ASSEMBLY INSTRUCTIONS

HOSE ASSEMBLY EQUIPMENT

APPENDICES

Pipe to SAE O-Ring

Internal Pipe Swivel (NPSM)/SAE O-Ring Boss (adj.)

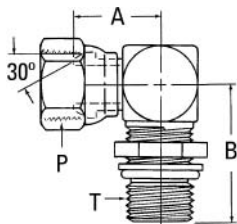

Part No. 2068-(Dash size)

Dash Size	Thread P	Thread T	A		B	
			mm	in	mm	in
4-4S	1/4-18	7/16-20	23,1	0.91	29,5	1.16
4-6S	1/4-18	9/16-18	18,5	0.73	31,8	1.25
6-6S	3/8-18	9/16-18	27,7	1.09	34,3	1.35
6-8S	3/8-18	3/4-16	27,7	1.09	37,6	1.48
8-8S	1/2-14	3/4-16	27,4	1.08	38,3	1.51
8-10S	1/2-14	7/8-14	27,4	1.08	42,4	1.67
12-8S	3/4-14	3/4-16	26,2	1.03	38,1	1.50
12-10S	3/4-14	7/8-14	27,7	1.09	43,2	1.70
12-12S	3/4-14	1 1/16-12	34,5	1.36	50,0	1.97
16-16S	1-11 1/2	1 5/16-12	38,9	1.53	53,9	2.12
20-16S	1 1/4-11 1/2	1 5/16-12	43,2	1.70	41,1	1.62
20-20S	1 1/4-11 1/2	1 5/8-12	41,1	1.62	60,7	2.39

NOTE: Available without O-ring. Order by Part No. 2068-1-(Dash size).

Internal Pipe/SAE O-Ring Boss (adj.)

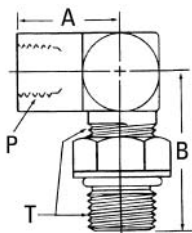

Part No. 206801-(Dash size)

Dash Size	Thread P	Thread T	A		B	
			mm	in	mm	in
6-8S	3/8-18	3/4-16	25,9	1.02	41,1	1.62
8-8S	1/2-14	3/4-16	31,2	1.23	43,9	1.73
12-12S	3/4-14	1 1/16-12	34,5	1.36	55,2	2.17
16-16S	1-11 1/2	1 5/16-12	41,1	1.62	61,2	2.41

NOTE: Available without O-ring. Order by Part No. 206801-1-(Dash size).

Internal Pipe/SAE O-Ring Boss (adj.)

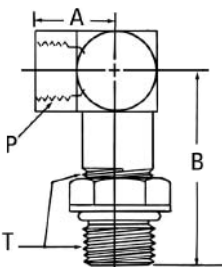

Part No. 206804-(Dash size)

Dash Size	Thread P	Thread T	A		B	
			mm	in	mm	in
6-8S	3/8-18	3/4-16	25,9	1.02	75,4	2.97
8-10S	1/2-14	7/8-14	31,2	1.23	90,4	3.56
12-12S	3/4-14	1 1/16-12	34,5	1.36	104,6	4.12
16-16S	1-11 1/2	1 5/16-12	41,1	1.62	117,8	4.64

NOTE: Available without O-ring. Order by Part No. 206804-1-(Dash size).

Pipe to Braze & Weld

Braze Port/ External Pipe

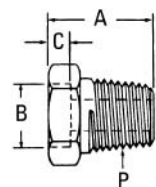

Part No. 73056-(Dash size)

Dash Size	Tube O.D.		Thread P	A		B		C	
	mm	in		mm	in	mm	in	mm	in
16S	25,4	1.00	1-11 1/2	33,6	1.32	25,4	1.00	6,4	0.25
32S	50,8	2.00	2-11 1/2	38,9	1.53	50,8	2.00	6,4	0.25

Braze Port/ External Pipe

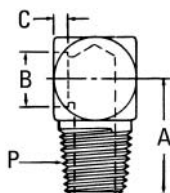

Part No. FF1159-(Dash size)

Dash Size	Tube O.D.		Thread P	A		B		C	
	mm	in		mm	in	mm	in	mm	in
0406S	9,6	0.38	1/4-18	22,9	0.90	9,7	0.38	4,0	0.16
2020S	31,7	1.25	1 1/4-11 1/2	59,7	2.35	31,8	1.25	6,4	0.25

SAE 37° (JIC) Flare Union

Union 37° Flare/ 37° Flare

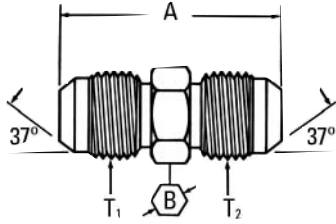

Part No. 2027-(Dash size) (Ref. SAE 070101)

Dash Size	Tube O.D.		Thread T1	Thread T2	A		B	
	mm	in			mm	in	mm	in
3-3S	4,8	0.19	3/8-24	3/8-24	31,2	1.23	11,2	0.44
4-4S	6,3	0.25	7/16-20	7/16-20	34,8	1.37	12,7	0.50
5-4S	6,3	0.25	1/2-20	7/16-20	34,8	1.37	14,2	0.56
5-5S	7,9	0.31	1/2-20	1/2-20	34,8	1.37	14,2	0.56
6-4S	6,3	0.25	9/16-18	7/16-20	35,6	1.40	15,7	0.62
6-5S	7,9	0.31	9/16-18	1/2-20	35,6	1.40	15,7	0.62
6-6S	9,6	0.38	9/16-18	9/16-18	35,8	1.41	15,7	0.62
8-4S	6,3	0.25	3/4-16	7/16-20	38,3	1.51	20,6	0.81
8-6S	9,6	0.38	3/4-16	9/16-18	38,6	1.52	20,6	0.81
8-8S	12,7	0.50	3/4-16	3/4-16	41,1	1.62	20,6	0.81
10-5S	7,9	0.31	7/8-14	1/2-20	42,4	1.67	23,9	0.94
10-6S	9,6	0.38	7/8-14	9/16-18	42,7	1.68	23,9	0.94
10-8S	12,7	0.50	7/8-14	3/4-16	45,2	1.78	23,9	0.94
10-10S	16,0	0.63	7/8-14	7/8-14	47,7	1.88	23,9	0.94
12-8S	9,6	0.38	1 1/16-12	3/4-16	49,5	1.95	28,5	1.12
12-10S	15,5	0.61	1 1/16-12	7/8-14	52,0	2.05	28,5	1.12
12-12S	19,0	0.75	1 1/16-12	1 1/16-12	54,9	2.16	28,5	1.12
14-14S	21,1	0.83	1 3/16-12	1 3/16-12	56,1	2.21	31,8	1.25
16-12S	19,0	0.75	1 5/16-12	1 1/16-12	55,9	2.20	35,1	1.38
16-16S	25,4	1.00	1 5/16-12	1 5/16-12	57,2	2.25	35,1	1.38
20-20S	31,7	1.25	1 5/8-12	1 5/8-12	61,7	2.43	42,9	1.69
24-24S	38,1	1.50	1 7/8-12	1 7/8-12	69,8	2.75	50,8	2.00
32-32S	50,8	2.00	2 1/2-12	2 1/2-12	86,4	3.40	66,5	2.62

Also available in stainless steel as part no. 259-2027.
See pg. 280 for more information.

37° Flare/37° Flare (Large Hex)

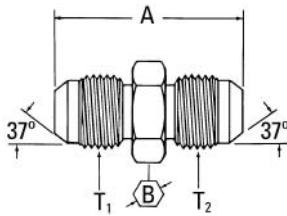

Part No. 202712-(Dash size) (Ref. SAE 070119)

Dash Size	Tube O.D.		Thread T1	Thread T2	A		B	
	mm	in			mm	in	mm	in
5-5S	7,9	0.31	1/2-20	1/2-20	34,8	1.37	19,0	0.75
6-4S	6,3	0.25	9/16-18	7/16-20	35,6	1.40	20,6	0.81
6-5S	7,9	0.31	9/16-18	1/2-20	35,6	1.40	20,6	0.81
8-8S	12,7	0.50	3/4-16	3/4-16	41,1	1.62	25,4	1.00
10-8S	12,7	0.50	7/8-14	3/4-16	45,2	1.78	28,5	1.12
10-10S	16,0	0.63	7/8-14	7/8-14	47,7	1.88	28,5	1.12
12-10S	16,0	0.63	1 1/16-12	7/8-14	52,0	2.05	35,1	1.38
12-12S	19,0	0.75	1 1/16-12	1 1/16-12	54,9	2.16	35,1	1.38
16-12S	19,0	0.75	1 5/16-12	1 1/16-12	55,9	2.20	41,1	1.62
16-16S	25,4	1.00	1 5/16-12	1 5/16-12	57,2	2.25	41,1	1.62
24-24S	38,1	1.50	1 7/8-12	1 7/8-12	69,8	2.75	53,9	2.12

SPECIALTY &
TRUCK HOSE

LOW & MEDIUM
PRESSURE HOSE

HIGH PRESSURE HOSE

HOSE FITTINGS

ADAPTERS &
TUBE FITTINGS

ACCESSORIES &
ASSEMBLY INSTRUCTIONS

HOSE ASSEMBLY
EQUIPMENT

APPENDICES

37° Flare Bulkhead/37° Flare

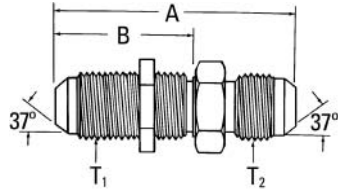

Part No. 2041-(Dash size) (Ref. SAE 070601)

Dash Size	Tube O.D.		Thread T1	Thread T2	A		B	
	mm	in			mm	in	mm	in
4-4S	6,3	0.25	7/16-20	7/16-20	52,6	2.07	31,2	1.23
4-6S	9,6	0.38	7/16-20	9/16-18	53,3	2.10	31,2	1.23
5-5S	7,9	0.31	1/2-20	1/2-20	52,6	2.07	31,2	1.23
6-6S	9,6	0.38	9/16-18	9/16-18	55,4	2.18	33,3	1.31
8-8S	12,7	0.50	3/4-16	3/4-16	62,0	2.44	37,3	1.47
10-10S	16,0	0.63	7/8-14	7/8-14	69,6	2.74	40,9	1.61
12-12S	19,0	0.75	1 1/16-12	1 1/16-12	78,5	3.09	45,2	1.78
12-16S	25,4	1.00	1 1/16-12	1 5/16-12	79,7	3.14	45,2	1.78
16-16S	25,4	1.00	1 5/16-12	1 5/16-12	79,7	3.14	45,2	1.78
20-20S	31,7	1.25	1 5/8-12	1 5/8-12	84,1	3.31	46,5	1.83
24-24S	38,1	1.50	1 7/8-12	1 7/8-12	89,4	3.52	46,7	1.84

NOTE: Available without nut. Order by Part No. 2041-1-(Dash size).

37° Flare Plug

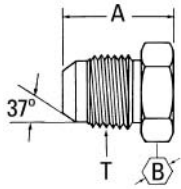

Part No. 900599-(Dash size) (Ref. SAE 070109)

Dash Size	Tube O.D.		Thread T	A		B	
	mm	in		mm	in	mm	in
3S	4,8	0.19	3/8-24	18,5	0.73	11,2	0.44
4S	6,3	0.25	7/16-20	20,3	0.80	12,7	0.50
5S	7,9	0.31	1/2-20	20,3	0.80	14,2	0.56
6S	9,6	0.38	9/16-18	21,3	0.84	15,7	0.62
8S	12,7	0.50	3/4-16	23,9	0.94	20,6	0.81
10S	16,0	0.63	7/8-14	27,9	1.10	23,9	0.94
12S	19,0	0.75	1 1/16-12	32,5	1.28	28,5	1.12
16S	25,4	1.00	1 5/16-12	33,8	1.33	35,1	1.38
20S	31,7	1.25	1 5/8-12	36,8	1.45	42,9	1.69
24S	38,1	1.50	1 7/8-12	41,9	1.65	50,8	2.00
32S	50,8	2.00	2 1/2-12	52,0	2.05	66,5	2.62

Cap Nut

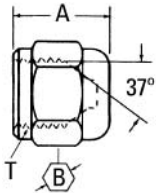

Part No. 210292-(Dash size) (Ref. SAE 070112)

Dash Size	Tube O.D.		Thread T	A		B	
	mm	in		mm	in	mm	in
3S	4,8	0.19	3/8-24	14,2	0.56	11,2	0.44
4S	6,3	0.25	7/16-20	15,0	0.59	14,2	0.56
5S	7,9	0.31	1/2-20	15,5	0.61	15,7	0.62
6S	9,6	0.38	9/16-18	15,7	0.62	17,6	0.69
8S	12,7	0.50	3/4-16	19,0	0.75	22,4	0.88
10S	16,0	0.63	7/8-14	21,3	0.84	25,4	1.00
12S	19,0	0.75	1 1/16-12	23,1	0.91	31,8	1.25
16S	25,4	1.00	1 5/16-12	25,9	1.02	38,1	1.50
20S	31,7	1.25	1 5/8-12	26,9	1.06	50,8	2.00
24S	38,1	1.50	1 7/8-12	30,3	1.19	57,2	2.25
32S	50,8	2.00	2 1/2-12	36,6	1.44	73,1	2.88

37° Flare (Internal)/ 37° Flare

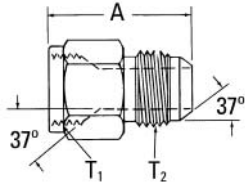

Part No. 2215-(Dash size)

Dash Size	Tube O.D.		Thread T1	Thread T2	A	
	mm	in			mm	in
6-5S	7,9	0.31	9/16-18	1/2-20	30,0	1.18
10-8S	12,7	0.50	7/8-14	3/4-16	38,9	1.53
10-12S	19,0	0.75	7/8-14	1/16-12	44,2	1.74
12-10S	16,0	0.63	1 1/16-12	7/8-14	43,9	1.73
12-16S	25,4	1.00	1 1/16-12	1 5/16-12	50,8	2.00
16-20S	31,7	1.25	1 5/16-12	1 5/8-12	58,4	2.30
24-20S	31,7	1.25	1 7/8-12	1 5/8-12	58,4	2.30

37° Flare Swivel (Reducer)/37° Flare

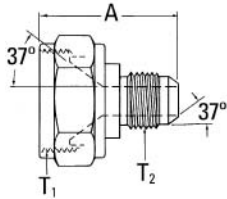

Part No. 221501-(Dash size) (Ref. SAE 070123)

Dash Size	Male Tube O.D.		Thread T1	Thread T2	A	
	mm	in			mm	in
6-4S	6,3	0.25	9/16-18	7/16-20	35,6	1.40
8-4S	6,3	0.25	3/4-16	7/16-20	38,1	1.50
8-6S	9,6	0.38	3/4-16	9/16-18	38,1	1.50
10-6S	9,6	0.38	7/8-14	9/16-18	41,1	1.62
12-6S	9,6	0.38	1 1/16-12	9/16-18	42,9	1.69
12-8S	12,7	0.50	1 1/16-12	3/4-16	45,5	1.79
16-6S	9,6	0.38	1 5/16-12	9/16-18	46,7	1.84
16-8S	12,7	0.50	1 5/16-12	3/4-16	49,3	1.94
16-10S	16,0	0.63	1 5/16-12	7/8-14	51,8	2.04
16-12S	19,0	0.75	1 5/16-12	1 1/16-12	54,6	2.15
20-16S	25,4	1.00	1 5/8-12	1 5/16-12	56,6	2.23

NOTE: Available without nut. Order by Part No. FF1066-(Dash size).

37° Flare Bulkhead/ 37° Flare

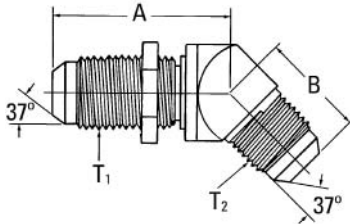

Part No. 2042-(Dash size) (Ref. SAE 070801)

Dash Size	Tube O.D.		Thread T1	Thread T2	A		B	
	mm	in			mm	in	mm	in
3-3S	4,8	0.19	3/8-24	3/8-24	35,1	1.38	18,3	0.72
4-4S	6,3	0.25	7/16-20	7/16-20	38,9	1.53	19,5	0.77
5-5S	7,9	0.31	1/2-20	1/2-20	42,2	1.66	19,0	0.75
6-6S	9,6	0.38	9/16-18	9/16-18	42,4	1.67	21,0	0.83
8-8S	12,7	0.50	3/4-16	3/4-16	49,3	1.94	24,9	0.98
10-10S	16,0	0.63	7/8-14	7/8-14	55,2	2.17	28,2	1.11
12-12S	19,0	0.75	1 1/16-12	1 1/16-12	59,9	2.36	35,8	1.41
16-16S	25,4	1.00	1 5/16-12	1 5/16-12	65,5	2.58	37,3	1.47
20-20S	31,7	1.25	1 5/8-12	1 5/8-12	64,3	2.53	42,9	1.69

NOTE: Available without nut. Order by Part No. 2042-1-(Dash size).

37° Flare Swivel/ 37° Flare

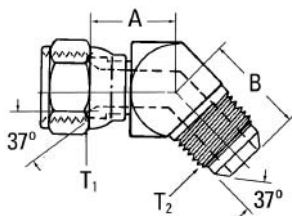

Part No. 2070-(Dash size) (Ref. SAE 070321)

Dash Size	Tube O.D.		Thread T1	Thread T2	A		B	
	mm	in			mm	in	mm	in
4-4S	6,3	0.25	7/16-20	7/16-20	15,2	0.60	18,3	0.72
5-5S	7,9	0.31	1/2-20	1/2-20	15,7	0.62	19,5	0.77
6-6S	9,6	0.38	9/16-18	9/16-18	18,8	0.74	21,0	0.83
8-8S	12,7	0.50	3/4-16	3/4-16	21,8	0.86	24,9	0.98
10-10S	16,0	0.63	7/8-14	7/8-14	23,9	0.94	28,2	1.11
12-12S	19,0	0.75	1 1/16-12	1 1/16-12	23,9	0.94	32,5	1.28
16-16S	25,4	1.00	1 5/16-12	1 5/16-12	29,5	1.16	37,3	1.47

SPECIALTY &
TRUCK HOSE

LOW & MEDIUM
PRESSURE HOSE

HIGH PRESSURE HOSE

HOSE FITTINGS

ADAPTERS &
TUBE FITTINGS

ACCESSORIES &
ASSEMBLY INSTRUCTIONS

HOSE ASSEMBLY
EQUIPMENT

APPENDICES

37° Flare/37° Flare

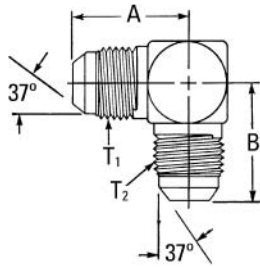

Part No. 2039-(Dash size) (Ref. SAE 070201)

Dash Size	Tube O.D.		Thread T1	Thread T2	A		B	
	mm	in			mm	in	mm	in
4-4S	6,3	0.25	7/16-20	7/16-20	22,6	0.89	22,6	0.89
5-5S	7,9	0.31	1/2-20	1/2-20	24,1	0.95	24,1	0.95
6-6S	9,6	0.38	9/16-18	9/16-18	26,9	1.06	26,9	1.06
8-6S	9,6	0.38	3/4-16	9/16-16	31,8	1.25	29,0	1.14
8-8S	12,7	0.50	3/4-16	3/4-16	31,8	1.25	31,8	1.25
10-10S	16,0	0.63	7/8-14	7/8-14	36,8	1.45	36,8	1.45
12-12S	19,0	0.75	1 1/16-12	1 1/16-12	42,2	1.66	42,2	1.66
16-12S	19,0	0.75	1 5/16-12	1 1/16-12	46,0	1.81	44,7	1.76
16-16S	25,4	1.00	1 5/16-12	1 5/16-12	46,0	1.81	46,0	1.81
20-20S	31,7	1.25	1 5/8-12	1 5/8-12	52,3	2.06	52,3	2.06
24-24S	38,1	1.50	1 7/8-12	1 7/8-12	59,2	2.33	59,2	2.33
32-32S	50,8	2.00	2 1/2-12	2 1/2-12	77,7	3.06	77,7	3.06

Also available in stainless steel as part no. 259-2039. See pg. 280 for more information.

37° Flare Bulkhead/ 37° Flare

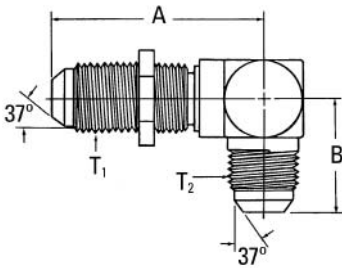

Part No. 2043-(Dash size) (Ref. SAE 070701)

Dash Size	Tube O.D.		Thread T1	Thread T2	A		B	
	mm	in			mm	in	mm	in
4-4S	6,3	0.25	7/16-20	7/16-20	40,4	1.59	24,6	0.97
5-5S	7,9	0.31	1/2-20	1/2-20	43,7	1.72	26,9	1.06
6-6S	9,6	0.38	9/16-18	9/16-18	46,0	1.81	27,7	1.09
8-8S	12,7	0.50	3/4-16	3/4-16	53,6	2.11	34,5	1.36
10-10S	16,0	0.63	7/8-14	7/8-14	60,7	2.39	39,6	1.56
12-12S	19,0	0.75	1 1/16-12	1 1/16-12	67,8	2.67	45,2	1.78
16-16S	25,4	1.00	1 5/16-12	1 5/16-12	71,1	2.80	49,3	1.94
20-20S	31,7	1.25	1 5/8-12	1 5/8-12	79,2	3.12	55,9	2.20

NOTE: Available without nut. Order by Part No. 2043-1-(Dash size).

37° Flare Swivel/ 37° Flare

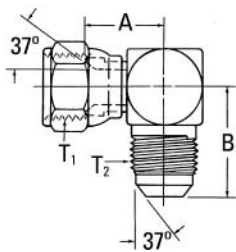

Part No. 2071-(Dash size) (Ref. SAE 070221)

Dash Size	Tube O.D.		Thread T1	Thread T2	A		B	
	mm	in			mm	in	mm	in
4-4S	6,3	0.25	7/16-20	7/16-20	16,8	0.66	22,6	0.89
4-6S	9,6	0.38	7/16-20	9/16-18	20,8	0.82	26,9	1.06
5-5S	7,9	0.31	1/2-20	1/2-20	17,3	0.68	24,1	0.95
6-6S	9,6	0.38	9/16-18	9/16-18	22,4	0.88	26,9	1.06
8-8S	12,7	0.50	3/4-16	3/4-16	24,4	0.96	31,8	1.25
10-8S	12,7	0.50	7/8-14	3/4-16	28,5	1.12	33,8	1.33
10-10S	16,0	0.63	7/8-14	7/8-14	28,5	1.12	36,8	1.45
12-12S	19,0	0.75	1 1/16-12	1 1/16-12	30,3	1.19	42,2	1.66
14-14S	22,3	0.88	1 3/16-12	1 3/16-12	30,5	1.20	45,7	1.80
16-16S	25,4	1.00	1 5/16-12	1 5/16-12	35,8	1.41	46,0	1.81
20-20S	31,7	1.25	1 5/8-12	1 5/8-12	42,7	1.68	52,3	2.06
24-24S	38,1	1.50	1 7/8-12	1 7/8-12	47,2	1.86	59,2	2.33

Also available in stainless steel as part no. 259-2071. See pg. 280 for more information.

37° Flare Swivel/ 37° Flare*

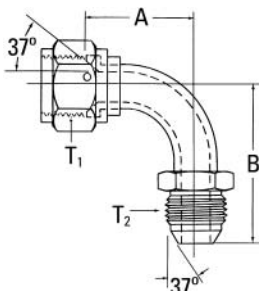

Part No. FF5163-(Dash size)

Dash Size	Tube O.D.		Thread T1	Thread T2	A		B	
	mm	in			mm	in	mm	in
0808S	12,7	0.50	3/4-16	3/4-16	47,5	1.87	54,9	2.16
1212S	19,0	0.75	1 1/16-12	1 1/16-12	59,7	2.35	71,4	2.81
1616S	25,4	1.00	1 5/16-12	1 5/16-12	77,2	3.04	86,6	3.41
2020S	31,7	1.25	1 5/8-12	1 5/8-12	86,4	3.40	94,2	3.71
2424S	38,1	1.50	1 7/8-12	1 7/8-12	100,3	3.95	110,0	4.33

*Suitable for pressures through heavy spiral hose - SAE 100R10.

**37° Flare Swivel/
37° Flare***

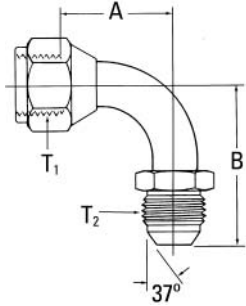

Part No. 500454-(Dash size)

Dash Size	Tube O.D.		Thread T1	Thread T2	A		B	
	mm	in			mm	in	mm	in
4S	6,3	0.25	7/16-20	7/16-20	17,3	0.68	28,5	1.12
5S	7,9	0.31	1/2-20	1/2-20	19,5	0.77	31,5	1.24
6S	9,6	0.38	9/16-18	9/16-18	21,6	0.85	33,3	1.31
8S	12,7	0.50	3/4-16	3/4-16	27,7	1.09	42,2	1.66
10S	16,0	0.63	7/8-14	7/8-14	31,2	1.23	46,2	1.82
12S	19,0	0.75	1 1/16-12	1 1/16-12	46,2	1.82	63,2	2.49
16S	25,4	1.00	1 5/16-12	1 5/16-12	60,7	2.39	70,9	2.79
20S	31,7	1.25	1 5/8-12	1 5/8-12	69,8	2.75	79,7	3.14

*Suitable for pressures through 4 light spiral hose - SAE 100R9.

**37° Flare Swivel/
37° Flare***

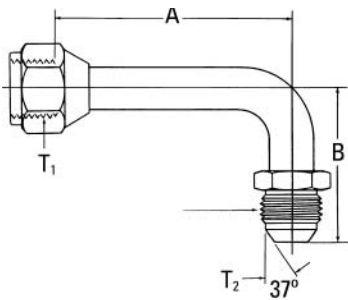

Part No. 504095-(Dash size)

Dash Size	Tube O.D.		Thread T1	Thread T2	A		B	
	mm	in			mm	in	mm	in
4S	6,3	0.25	7/16-20	7/16-20	45,7	1.80	28,5	1.12
5S	7,9	0.31	1/2-20	1/2-20	44,9	1.77	31,5	1.24
6S	9,6	0.38	9/16-18	9/16-18	55,4	2.18	33,3	1.31
8S	12,7	0.50	3/4-16	3/4-16	61,7	2.43	45,2	1.78
10S	16,0	0.63	7/8-14	7/8-14	65,3	2.57	52,6	2.07
12S	19,0	0.75	1 1/16-12	1 1/16-12	94,7	3.73	63,2	2.49
16S	25,4	1.00	1 5/16-12	1 5/16-12	116,3	4.58	70,9	2.79
20S	31,7	1.25	1 5/8-12	1 5/8-12	140,5	5.53	79,7	3.14

*Suitable for pressures through 4 light spiral hose - SAE 100R9

**37° Flare Swivel/
37° Flare***

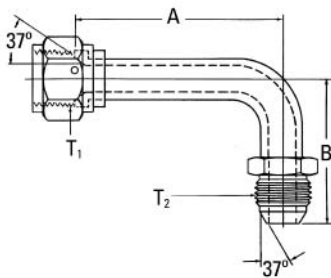

Part No. FF5164-(Dash size)

Dash Size	Tube O.D.		Thread T1	Thread T2	A		B	
	mm	in			mm	in	mm	in
3808S	12,7	0.50	3/4-16	3/4-16	84,8	3.34	54,9	2.16
1212S	19,0	0.75	1 1/16-12	1 1/16-12	112,0	4.41	71,4	2.81
1616S	25,4	1.00	1 5/16-12	1 5/16-12	133,1	5.24	86,6	3.41
2020S	31,7	1.25	1 5/8-12	1 5/8-12	164,6	6.48	94,2	3.71

*Suitable for pressures through heavy spiral hose - SAE 100R10

**37° Flare/
37° Flare/37° Flare**

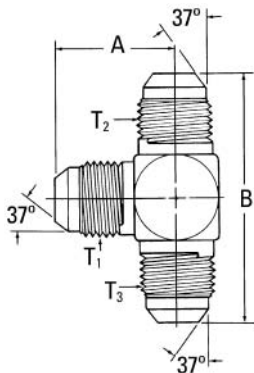

Part No. 2033-(Dash size) (Ref. SAE 070401)

Dash Size	Thread T1	Thread T2	Thread T3	A		B	
				mm	in	mm	in
4-4S	7/16-20	7/16-20	7/16-20	22,6	0.89	45,2	1.78
5-5S	1/2-20	1/2-20	1/2-20	24,1	0.95	48,3	1.90
6-6S	9/16-18	9/16-18	9/16-18	26,9	1.06	53,3	2.10
8-6-6S	3/4-16	9/16-18	9/16-18	31,8	1.25	57,9	2.28
8-8S	3/4-16	3/4-16	3/4-16	31,8	1.25	63,5	2.50
8-12-12S	3/4-16	1 1/16-12	1 1/16-12	36,1	1.42	84,3	3.32
10-10S	7/8-14	7/8-14	7/8-14	36,8	1.45	73,7	2.90
12-12S	1 1/16-12	1 1/16-12	1 1/16-12	42,2	1.66	84,3	3.32
12-12-16S	1 1/16-12	1 1/16-12	1 5/16-12	46,7	1.84	92,7	3.65
16-16S	1 5/16-12	1 5/16-12	1 5/16-12	46,0	1.81	91,9	3.62
16-16-20S	1 5/16-12	1 5/16-12	1 5/8-12	52,8	2.08	103,1	4.06
20-12-16S	1 5/8-12	1 1/16-12	1 5/16-12	52,3	2.06	103,9	4.09
20-16-16S	1 5/8-12	1 5/16-12	1 5/16-12	52,3	2.06	107,2	4.22
20-20S	1 5/8-12	1 5/8-12	1 5/8-12	52,3	2.06	111,2	4.38

**37° Flare Bulkhead/
37° Flare**

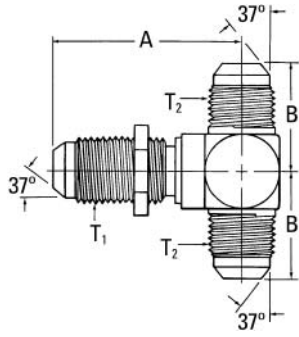

Part No. 203002-(Dash size) (Ref. SAE 070959)

Dash Size	Tube O.D.		Thread T1	Thread T2	A		B	
	mm	in			mm	in	mm	in
4-4S	6,3	0.25	7/16-20	7/16-20	40,4	1.59	23,4	0.92
5-5S	7,9	0.31	1/2-20	1/2-20	41,1	1.62	24,1	0.95
6-6S	9,6	0.38	9/16-18	9/16-18	46,0	1.81	26,9	1.06
8-8S	12,7	0.50	3/4-16	3/4-16	53,6	2.11	31,5	1.24
10-10S	16,0	0.63	7/8-14	7/8-14	60,7	2.39	36,6	1.44
12-12S	19,0	0.75	1 1/16-12	1 5/16-12	67,8	2.67	43,7	1.72
16-16S	25,4	1.00	1 5/8-12	1 5/8-12	71,1	2.80	49,3	1.94

NOTE: Available without nut. Order by Part No. 203002-1-(Dash size).

**37° Flare Bulkhead/
37° Flare**

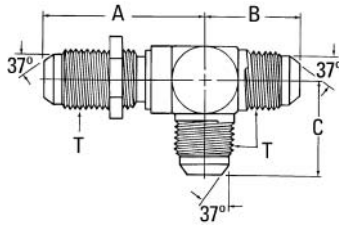

Part No. 203008-(Dash size) (Ref. SAE 070958)

Dash Size	Tube O.D.		Thread T1	A		B		C	
	mm	in		mm	in	mm	in	mm	in
6-6S	9,6	0.38	9/16-18	46,0	1.81	27,7	1.09	27,7	1.09
8-8S	12,7	0.50	3/4-16	53,6	2.11	34,5	1.36	34,5	1.36
12-12S	19,0	0.75	1 1/16-12	67,8	2.67	42,2	1.66	42,2	1.66
16-16S	25,4	1.00	1 5/8-12	71,1	2.80	49,3	1.94	49,3	1.94
20-20S	31,7	1.25	1 5/8-12	79,2	3.12	55,6	2.19	52,3	2.06

NOTE: Available without nut. Order by Part No. FF1065-(Dash size).

**37° Flare Swivel/
37° Flare/37° Flare**

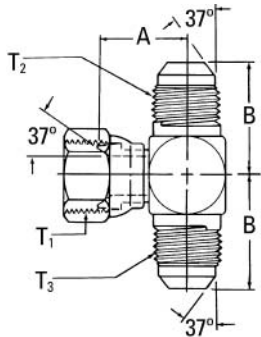

Part No. 203101-(Dash size) (Ref. SAE 070433)

Dash Size	Thread T1	Thread T2	Thread T3	A		B	
				mm	in	mm	in
4-4S	7/16-20	7/16-20	7/16-20	22,6	0.89	45,2	1.78
4-4S	7/16-20	7/16-20	7/16-20	16,8	0.66	22,6	0.89
6-6S	9/16-18	9/16-18	9/16-18	22,4	0.88	26,7	1.05
8-8S	3/4-16	3/4-16	3/4-16	24,4	0.96	31,8	1.25
10-10S	7/8-14	7/8-14	7/8-14	28,5	1.12	36,8	1.45
12-12S	1 1/16-12	1 1/16-12	1 1/16-12	30,3	1.19	42,2	1.66
16-16S	1 5/8-12	1 5/8-12	1 5/8-12	35,8	1.41	46,0	1.81
20-20S	1 5/8-12	1 5/8-12	1 5/8-12	39,4	1.55	52,3	2.06

**37° Flare Bulkhead/
37° Flare/37° Flare**

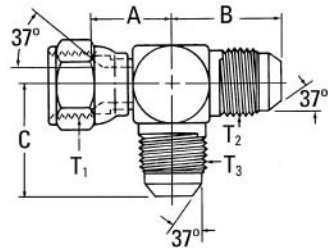

Part No. 203102-(Dash size) (Ref. SAE 070432)

Dash Size	Tube O.D.		Thread T1	Thread T2	Thread T3	A		B		C	
	mm	in				mm	in	mm	in	mm	in
4-4S	6,3	0.25	7/16-20	7/16-20	7/16-20	16,8	0.66	22,6	0.89	22,6	0.89
5-5S	7,9	0.31	1/2-20	1/2-20	1/2-20	17,3	0.68	24,1	0.95	24,1	0.95
6-6S	9,6	0.38	9/16-18	9/16-18	9/16-18	22,4	0.88	26,9	1.06	26,9	1.06
8-8S	12,7	0.50	3/4-16	3/4-16	3/4-16	24,4	0.96	31,8	1.25	31,8	1.25
10-10S	16,0	0.63	7/8-14	7/8-14	7/8-14	28,5	1.12	36,8	1.45	36,8	1.45
10-10-12S	19,0	0.75	7/8-14	7/8-14	1 1/16-12	28,7	1.13	39,1	1.54	42,2	1.66
12-12S	19,0	0.75	1 1/16-12	1 1/16-12	1 1/16-12	30,3	1.19	42,2	1.66	42,2	1.66
16-16S	25,4	1.00	1 5/8-12	1 5/8-12	1 5/8-12	35,8	1.41	46,0	1.81	46,0	1.81
20-20S	31,7	1.25	1 5/8-12	1 5/8-12	1 5/8-12	42,7	1.68	52,3	2.06	52,3	2.06

37° Flare

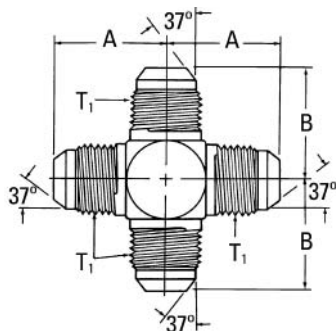

Part No. 2020-(Dash size) (Ref. SAE 070501)

Dash Size	Tube O.D.		Thread T1	A		B	
	mm	in		mm	in	mm	in
4-4S	6,3	0.25	7/16-20	22,6	0.89	22,6	0.89
5-5S	7,9	0.31	1/2-20	24,1	0.95	24,1	0.95
6-6S	9,6	0.38	9/16-18	26,9	1.06	26,9	1.06
8-8S	12,7	0.50	3/4-16	31,8	1.25	31,8	1.25
10-10S	16,0	0.63	7/8-14	36,8	1.45	36,8	1.45
12-12S	19,0	0.75	1 1/16-12	42,2	1.66	44,2	1.74
16-16S	25,4	1.00	1 5/16-12	46,0	1.81	49,8	1.96

Bulkhead Lock Nut

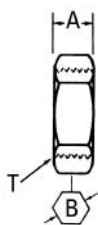

Part No. 210212-(Dash size) (Ref. SAE 070118)

Dash Size	Tube O.D.		Thread T1	A		B	
	mm	in		mm	in	mm	in
4S	6,3	0.25	7/16-20	6,4	0.25	17,6	0.69
5S	7,9	0.31	1/2-20	6,4	0.25	19,0	0.75
6S	9,6	0.38	9/16-18	6,8	0.27	20,6	0.81
8S	12,7	0.50	3/4-16	7,9	0.31	25,4	1.00
10S	16,0	0.63	7/8-14	9,1	0.36	28,5	1.12
12S	19,0	0.75	1 1/16-12	10,4	0.41	35,1	1.38
16S	25,4	1.00	1 5/16-12	10,4	0.41	41,1	1.62
20S	31,7	1.25	1 5/8-12	10,4	0.41	47,7	1.88
24S	38,1	1.50	1 7/8-12	10,4	0.41	53,9	2.12

SAE 45° Flare Union

SAE 45° Flare Bulkhead/45° Flare

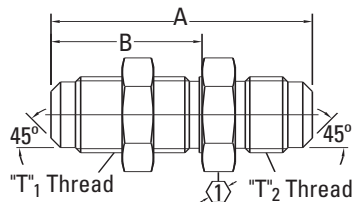

Part No. 2056-(Dash size)

Dash Size	Tube O.D.		Thread T1	Thread T2	A		B		①
	mm	in			mm	in	mm	in	
10-10S	16,0	0.63	7/8-14	7/8-14	75,9	2.99	43,9	1.73	28,5 1.12

Note: Available without nut. Order by Part No. 2056-1-(Dash size)

45° Flare/45° Flare

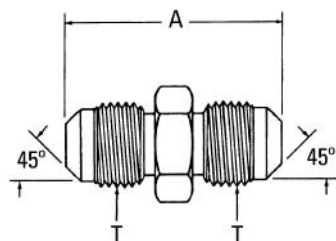

Part No. 2060-(Dash size)

(Ref. SAE 010101)

Dash Size	Tube O.D.		Thread T	A	
	mm	in		mm	in
2-2B	3,3	0.13	5/16-24	23,4	0.92
3-3B	4,8	0.19	3/8-24	26,9	1.06
4-4B	6,3	0.25	7/16-20	30,3	1.19
5-5B	7,9	0.31	1/2-20	34,0	1.34
6-6B	9,6	0.38	5/8-18	38,1	1.50
8-8B	12,7	0.50	3/4-16	46,0	1.81
10-10B	16,0	0.63	7/8-14	53,9	2.12
12-12B	19,0	0.75	1 1/16-14	62,0	2.44

SPECIALTY & TRUCK HOSE

LOW & MEDIUM PRESSURE HOSE

HIGH PRESSURE HOSE

HOSE FITTINGS

ADAPTERS & TUBE FITTINGS

ACCESSORIES & ASSEMBLY INSTRUCTIONS

HOSE ASSEMBLY EQUIPMENT

APPENDICES

SAE O-Ring to 37° Flare

SAE O-Ring Boss/ 37° Flare

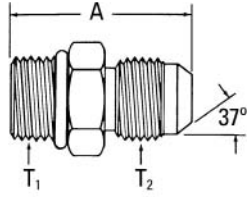

Part No. 202702-(Dash size) (Ref. SAE 070120)

Dash Size	Tube O.D.		Thread T1	Thread T2	A	
	mm	in			mm	in
4-4S	6,3	0.25	7/16-20	7/16-20	31,2	1.23
4-6S	9,6	0.38	7/16-20	9/16-18	32,3	1.27
4-8S	12,7	0.50	7/16-20	3/4-16	37,8	1.49
5-5S	7,9	0.31	1/2-20	1/2-20	31,2	1.23
5-6S	9,6	0.38	1/2-20	9/16-18	32,3	1.27
6-4S	6,3	0.25	9/16-18	7/16-20	32,8	1.29
6-6S	9,6	0.38	9/16-18	9/16-18	33,0	1.30
6-8S	12,7	0.50	9/16-18	3/4-16	36,6	1.44
6-10S	16,0	0.63	9/16-18	7/8-14	43,4	1.71
8-4S	6,3	0.25	3/4-16	7/16-20	34,8	1.37
8-5S	7,9	0.31	3/4-16	1/2-20	34,8	1.37
8-6S	9,6	0.38	3/4-16	9/16-18	35,1	1.38
8-8S	12,7	0.50	3/4-16	3/4-16	37,6	1.48
8-10S	16,0	0.63	3/4-16	7/8-14	41,6	1.64
8-12S	19,0	0.75	3/4-16	1 1/16-12	49,3	1.94
10-4S	6,3	0.25	7/8-14	7/16-20	37,8	1.49
10-6S	9,6	0.38	7/8-14	9/16-18	38,1	1.50
10-8S	12,7	0.50	7/8-14	3/4-16	40,6	1.60
10-10S	16,0	0.63	7/8-14	7/8-14	43,2	1.70
10-12S	19,0	0.75	7/8-14	1 1/16-12	47,7	1.88
10-16S	25,4	1.00	7/8-14	1 5/16-12	52,6	2.07
12-6S	9,6	0.38	1 1/16-12	9/16-18	42,2	1.66
12-8S	12,7	0.50	1 1/16-12	3/4-16	44,7	1.76
12-10S	16,0	0.63	1 1/16-12	7/8-14	47,2	1.86
12-12S	19,0	0.75	1 1/16-12	1 1/16-12	50,0	1.97
12-14S	22,3	0.88	1 1/16-12	1 3/16-12	50,5	1.99
12-16S	25,4	1.00	1 1/16-12	1 5/16-12	51,8	2.04
12-20S	31,7	1.25	1 1/16-12	1 5/8-12	58,4	2.30
14-10S	16,0	0.63	1 3/16-12	7/8-14	47,2	1.86
14-12S	19,0	0.75	1 3/16-12	1 1/16-12	49,8	1.96
14-16S	25,4	1.00	1 9/16-12	1 5/16-12	51,8	2.04
16-8S	12,7	0.50	1 5/16-12	3/4-16	45,5	1.79
16-10S	16,0	0.63	1 5/16-12	7/8-14	48,0	1.89
16-12S	19,0	0.75	1 5/16-12	1 1/16-12	50,5	1.99
16-16S	25,4	1.00	1 5/16-12	1 5/16-12	51,8	2.04
16-20S	31,7	1.25	1 5/16-12	1 5/8-12	59,2	2.33
20-12S	19,0	0.75	1 5/8-12	1 1/16-12	52,8	2.08
20-16S	25,4	1.00	1 5/8-12	1 5/16-12	53,9	2.12
20-20S	31,7	1.25	1 5/8-12	1 5/8-12	55,2	2.17
20-24S	38,1	1.50	1 5/8-12	1 7/8-12	64,3	2.53
24-16S	25,4	1.00	1 7/8-12	1 5/16-12	55,9	2.20
24-20S	31,7	1.25	1 7/8-12	1 5/8-12	56,9	2.24
24-24S	38,1	1.50	1 7/8-12	1 7/8-12	60,2	2.37
32-32S	50,8	2.00	2 1/2-12	2 1/2-12	70,6	2.78

Available without O-ring. Order by Part No. 202701-(Dash size).

Also available in stainless steel as part no. 259-202702.

See pg. 281 for more information.

SPECIALTY & TRUCK HOSE
LOW & MEDIUM PRESSURE HOSE
HIGH PRESSURE HOSE
HOSE FITTINGS
ADAPTERS & TUBE FITTINGS
ACCESSORIES & ASSEMBLY INSTRUCTIONS
HOSE ASSEMBLY EQUIPMENT
APPENDICES

**SAE O-Ring Boss/
37° Flare**

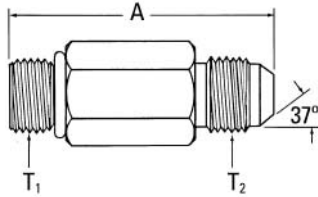

Part No. 202713-(Dash size)

Dash Size	Tube O.D.		Thread T1	Thread T2	A	
	mm	in			mm	in
6-6S	9,6	0.38	9/16-18	9/16-18	58,7	2.31
8-8S	12,7	0.50	3/4-16	3/4-16	68,6	2.70
10-10S	16,0	0.63	7/8-14	7/8-14	77,2	3.04
12-12S	19,0	0.75	1 1/16-12	1 1/16-12	91,7	3.61
16-16S	25,4	1.00	1 5/16-12	1 5/16-12	101,1	3.98

NOTE: Available without O-ring. Order by Part No. 202703-(Dash size).

**SAE O-Ring Boss/
37° Flare Swivel**

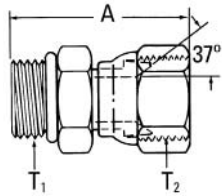

Part No. 2266-(Dash size)

Dash Size	Tube O.D.		Thread T1	Thread T2	A	
	mm	in			mm	in
6-8S	12,7	0.50	9/16-18	3/4-16	41,4	1.63
8-8S	12,7	0.50	3/4-16	3/4-16	39,4	1.55
10-10S	16,0	0.63	7/8-14	7/8-14	43,7	1.72
12-12S	19,0	0.75	1 1/16-12	1 1/16-12	48,3	1.90
16-16S	25,4	1.00	1 5/16-12	1 5/16-12	53,6	2.11

NOTE: Available without O-ring. Order by Part No. 226601-(Dash size).

**SAE O-Ring boss
(adj.)/37° flare**

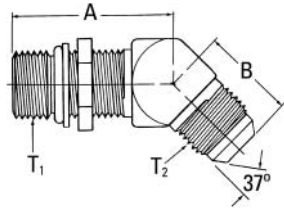

Part No. 2061-(Dash size) (Ref. SAE 070320)

Dash Size	Tube O.D.		Thread T1	Thread T2	A		B	
	mm	in			mm	in	mm	in
4-4S	6,3	0.25	7/16-20	7/16-20	26,7	1.05	18,3	0.72
5-5S	7,9	0.31	1/2-20	1/2-20	26,7	1.05	19,5	0.77
6-6S	9,6	0.38	9/16-18	9/16-18	29,0	1.14	21,0	0.83
8-8S	12,7	0.50	3/4-16	3/4-16	33,0	1.30	24,9	0.98
8-10S	16,0	0.63	3/4-16	7/8-14	34,5	1.36	28,2	1.11
10-8S	12,7	0.50	7/8-14	3/4-16	38,6	1.52	25,1	0.99
10-10S	16,0	0.63	7/8-14	7/8-14	38,6	1.52	28,2	1.11
12-12S	19,0	0.75	1 1/16-12	1 1/16-12	43,9	1.73	32,5	1.28
12-16S	25,4	1.00	1 1/16-12	1 5/16-12	47,2	1.86	37,3	1.47
16-12S	19,0	0.75	1 5/16-12	1 1/16-12	47,2	1.86	36,1	1.42
16-16S	25,4	1.00	1 5/16-12	1 5/16-12	47,2	1.86	37,3	1.47
20-16S	25,4	1.00	1 5/8-12	1 5/16-12	49,3	1.94	38,6	1.52
20-20S	31,7	1.25	1 5/8-12	1 5/8-12	49,3	1.94	41,4	1.63

NOTE: Available without O-ring. Order by Part No. 2061-1-(Dash size).

**SAE O-Ring Boss
(adj.)/37° Flare**

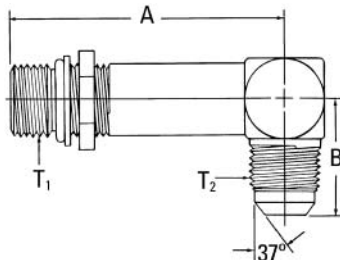

Part No. 206209-(Dash size)

Dash Size	Tube O.D.		Thread T1	Thread T2	A		B	
	mm	in			mm	in	mm	in
4-4S	6,3	0.25	7/16-20	7/16-20	43,9	1.73	22,6	0.89
6-6S	9,6	0.38	9/16-18	9/16-18	52,8	2.08	26,9	1.06
8-8S	12,7	0.50	3/4-16	3/4-16	63,0	2.48	31,8	1.25
8-10S	16,0	0.63	3/4-16	7/8-14	64,0	2.52	36,8	1.45
10-10S	16,0	0.63	7/8-14	7/8-14	73,4	2.89	36,8	1.45
12-12S	19,0	0.75	1 1/16-12	1 1/16-12	84,8	3.34	42,2	1.66
16-16S	25,4	1.00	1 5/16-12	1 5/16-12	94,5	3.72	46,0	1.81
20-20S	31,7	1.25	1 5/8-12	1 5/8-12	112,0	4.41	52,3	2.06

NOTE: Available without O-ring. Order by Part No. 206209-1-(Dash size).

SPECIALTY &
TRUCK HOSE

LOW & MEDIUM
PRESSURE HOSE

HIGH PRESSURE HOSE

HOSE FITTINGS

ADAPTERS &
TUBE FITTINGS

ACCESSORIES &
ASSEMBLY INSTRUCTIONS

HOSE ASSEMBLY
EQUIPMENT

APPENDICES

**SAE O-Ring Boss(adj.)/
37° Flare Swivel**

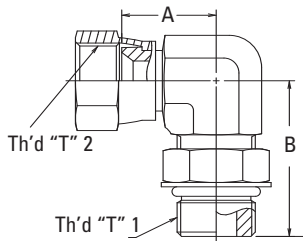

Part No. 2214-(Dash size)

Dash Size	Tube O.D.		Thread T1	Thread T2	A		B	
	mm	in			mm	in	mm	in
4-4S	6,3	0.25	7/16-20	7/16-20	17,3	0.68	27,9	1.10
6-4S	9,6	0.38	9/16-18	7/16-20	19,0	0.75	31,8	1.25
8-8S	12,7	0.50	3/4-16	3/4-16	23,9	0.94	36,8	1.45
12-12S	19,0	0.75	1 1/16-12	1 1/16-12	30,0	1.18	49,3	1.94

NOTE: Available without O-ring. Order by Part No. 2214-2-(Dash size).

**SAE O-Ring Boss(adj.)/
37° Flare**

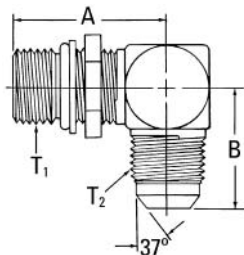

Part No. 2062-(Dash size) (Ref. SAE 070220)

Dash Size	Tube O.D.		Thread T1	Thread T2	A		B	
	mm	in			mm	in	mm	in
4-4S	6,3	0.25	7/16-20	7/16-20	26,2	1.03	22,6	0.89
4-6S	9,6	0.38	7/16-20	9/16-18	30,3	1.19	26,9	1.06
5-5S	7,9	0.31	1/2-20	1/2-20	28,7	1.13	24,1	0.95
5-6S	9,6	0.38	1/2-20	9/16-18	30,3	1.19	26,9	1.06
6-4S	6,3	0.25	9/16-18	7/16-20	31,8	1.25	26,7	1.05
6-6S	9,6	0.38	9/16-18	9/16-18	31,8	1.25	26,9	1.06
6-8S	12,7	0.50	9/16-18	3/4-16	33,6	1.32	31,8	1.25
8-5S	7,9	0.31	3/4-16	1/2-20	36,8	1.45	26,4	1.04
8-6S	9,6	0.38	3/4-16	9/16-18	36,8	1.45	29,0	1.14
8-8S	12,7	0.50	3/4-16	3/4-16	36,8	1.45	31,8	1.25
8-10S	16,0	0.63	3/4-16	7/8-14	39,1	1.54	36,8	1.45
10-6S	9,6	0.38	7/8-14	9/16-18	43,2	1.70	29,0	1.14
10-8S	12,7	0.50	7/8-14	3/4-16	43,2	1.70	33,8	1.33
10-10S	16,0	0.63	7/8-14	7/8-14	43,2	1.70	36,8	1.45
10-12S	19,0	0.75	7/8-14	1 1/16-12	45,2	1.78	42,2	1.66
12-8S	12,7	0.50	1 1/16-12	3/4-16	49,3	1.94	36,1	1.42
12-10S	16,0	0.63	1 1/16-12	7/8-14	49,3	1.94	39,1	1.54
12-12S	19,0	0.75	1 1/16-12	1 1/16-12	49,3	1.94	42,2	1.66
12-16S	25,4	1.00	1 1/16-12	1 5/16-12	52,0	2.05	46,0	1.81
12-20S	31,7	1.25	1 1/16-12	1 5/8-12	56,1	2.21	52,3	2.06
14-16S	25,4	1.00	1 3/16-12	1 5/16-12	52,3	2.06	46,0	1.81
16-8S	12,7	0.50	1 5/16-12	3/4-16	52,0	2.05	38,6	1.52
16-12S	19,0	0.75	1 5/16-12	1 1/16-12	52,0	2.05	44,7	1.76
16-16S	25,4	1.00	1 5/16-12	1 5/16-12	52,0	2.05	46,0	1.81
16-20S	31,7	1.25	1 5/16-12	1 5/8-12	56,1	2.21	52,3	2.06
20-16S	25,4	1.00	1 5/8-12	1 5/16-12	55,9	2.20	53,1	2.09
20-20S	31,7	1.25	1 5/8-12	1 5/8-12	57,2	2.25	52,3	2.06
20-24S	38,1	1.50	1 5/8-12	1 7/8-12	60,7	2.39	59,2	2.33
24-20S	31,7	1.25	1 7/8-12	1 5/8-12	60,7	2.39	55,9	2.20
24-24S	38,1	1.50	1 7/8-12	1 7/8-12	60,7	2.39	59,2	2.33

Note: Available without O-ring. Order by Part No. 2062-1-(Dash size). Also available in stainless steel as part no. 259-2062. See pg. 281 for more information.

**SAE O-Ring Boss(adj.)/
37° Flare**

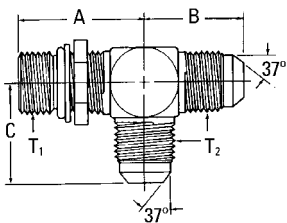

Part No. 203005-(Dash size) (Ref. SAE 070428)

Dash Size	Tube O.D.		Thread T1	Thread T2	A		B		C	
	mm	in			mm	in	mm	in	mm	in
4-4S	6,3	0.25	7/16-20	7/16-20	26,2	1.03	22,6	0.89	22,6	0.89
5-5S	7,9	0.31	1/2-20	1/2-20	27,7	1.09	24,4	0.96	24,1	0.95
6-4-4S			9/16-18	7/16-20	31,8	1.25	26,7	1.05	24,6	0.97
6-6S	9,6	0.38	9/16-18	9/16-18	31,8	1.25	26,9	1.06	26,9	1.06
8-8S	12,7	0.50	3/4-16	3/4-16	36,8	1.45	31,8	1.25	31,8	1.25
10-10S	16,0	0.63	7/8-14	7/8-14	43,2	1.70	36,8	1.45	36,8	1.45
12-12S	19,0	0.75	1 1/16-12	1 1/16-12	49,3	1.94	42,2	1.66	42,2	1.66
12-16-16S	25,4	1.00	1 1/16-12	1 5/16-12	52,0	2.05	46,0	1.81	46,0	1.81
16-16S	25,4	1.00	1 5/16-12	1 5/16-12	52,0	2.05	46,0	1.81	46,0	1.81
20-20S	31,7	1.25	1 5/8-12	1 5/8-12	57,2	2.25	55,6	2.19	52,3	2.06

NOTE: Available without O-ring. Order by Part No. 203005-1-(Dash size).

SPECIALTY & TRUCK HOSE
LOW & MEDIUM PRESSURE HOSE
HIGH PRESSURE HOSE
HOSE FITTINGS
ADAPTERS & TUBE FITTINGS
ACCESSORIES & ASSEMBLY INSTRUCTIONS
HOSE ASSEMBLY EQUIPMENT
APPENDICES

**SAE O-Ring Boss(adj.)/
37° Flare**

Part No. 203003-(Dash size) (Ref. SAE 070429)

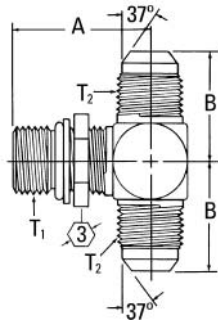

Dash Size	Tube O.D.		Thread T1	Thread T2	A		B	
	mm	in			mm	in	mm	in
4-4S	6,3	0.25	7/16-20	7/16-20	26,2	1.03	22,6	0.89
5-5S	7,9	0.31	1/2-20	1/2-20	27,4	1.08	24,1	0.95
6-6S	9,6	0.38	9/16-18	9/16-18	31,8	1.25	26,9	1.06
8-8S	12,7	0.50	3/4-16	3/4-16	36,8	1.45	31,8	1.25
10-10S	16,0	0.63	7/8-14	7/8-14	43,4	1.71	36,8	1.45
10-12-12S			7/8-14	1 1/16-12	45,7	1.80	42,2	1.66
12-12S	19,0	0.75	1 1/16-12	1 1/16-12	49,3	1.94	42,2	1.66
16-10-10S			1 5/16-12	7/8-14	52,0	2.05	41,6	1.64
16-16S	25,4	1.00	1 5/16-12	1 5/16-12	52,0	2.05	46,0	1.81
20-20S	31,7	1.25	1 5/8-12	1 5/8-12	57,6	2.27	52,3	2.06

SAE Split Flange to ORS

**ORS/Split Flange
(Code 62)**

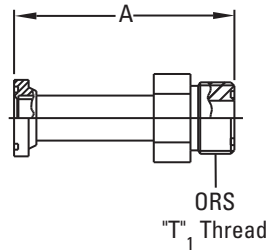

Part No. FF5943T(Size)

Dash Size	Tube O.D.		Thread T1	A	
	mm	in		mm	in
1612S	25,4	1.00	1.4375-12	69,8	2.75
1616S	25,4	1.00	1.4375-12	90,7	3.57
1620S	25,4	1.00	1.4375-12	90,7	3.57

**ORS/Split Flange
(Code 61)/ORS Male**

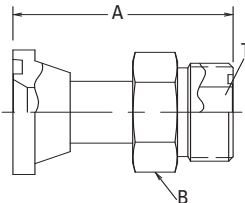

Part No. FF6033T(Dash size)

Dash Size	Split Flange Size	Tube O.D.		Thread T	A		B	
		mm	in		mm	in	mm	in
1624S	1	25,4	1.00	1 7/16-12	72,4	2.85	38,1	1.50

**45° ORS/Split Flange
(Code 61)**

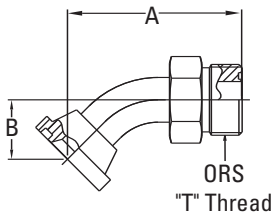

Part No. FF6001T(Size)

Dash Size	Tube O.D.		Thread T1	A Ref		B Ref	
	mm	in		mm	in	mm	in
1216S	19,0	0.75	1 3/16-12	74,7	2.94	25,4	1.00
1616S	25,4	1.00	1 7/16-12	86,6	3.41	26,9	1.06
2020S	31,7	1.25	1 11/16-12	91,9	3.62	29,2	1.15
2424S	38,1	1.50	2-12	57,2	2.25	35,8	1.41

**45° ORS/Split Flange
(Code 62)**

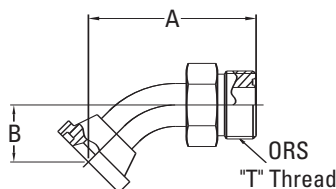

Part No. FF6002T(Size)

Dash Size	Tube O.D.		Thread T1	A Ref		B Ref	
	mm	in		mm	in	mm	in
1212S	19,0	0.75	1 3/16-12	74,7	2.94	25,4	1.00
1612S	25,4	1.00	1 7/16-12	74,7	2.94	25,4	1.00
1616S	25,4	1.00	1 7/16-12	86,6	3.41	26,9	1.06
2020S	31,7	1.25	1 11/16-12	91,9	3.62	29,2	1.15
2424S	38,1	1.50	2-12	107,9	4.25	35,8	1.41

**90° ORS/Split Flange
(Code 61)**

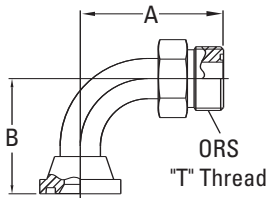

Part No. FF5946T(Size)

Dash Size	Tube O.D.		Thread T	A		B	
	mm	in		mm	in	mm	in
1212S	19,0	0.75	1 ³ / ₁₆ -12	67,3	2.65	54,1	2.13
1216S	19,0	0.75	1 ³ / ₁₆ -12	67,3	2.65	54,1	2.13
1616S	25,4	1.00	1 ⁷ / ₁₆ -12	81,8	3.22	60,2	2.37
2020S	31,7	1.25	1 ¹¹ / ₁₆ -12	88,1	3.47	66,5	2.62
2424S	38,1	1.50	2-12	100,8	3.97	79,2	3.12

**90° ORS/Split Flange
(Code 62)**

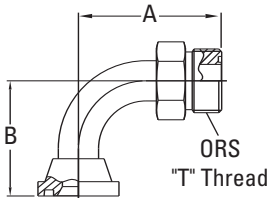

Part No. FF5945T(Size)

Dash Size	Tube O.D.		Thread T	A		B	
	mm	in		mm	in	mm	in
1212S	19,0	0.75	1 ³ / ₁₆ -12	67,3	2.65	54,1	2.13
1612S	25,4	1.00	1 ⁷ / ₁₆ -12	67,3	2.65	54,1	2.13
1616S	25,4	1.00	1 ⁷ / ₁₆ -12	81,8	3.22	60,2	2.37
1620S	25,4	1.00	1 ⁷ / ₁₆ -12	88,1	3.47	66,5	2.62
2020S	31,7	1.25	1 ¹¹ / ₁₆ -12	88,1	3.47	66,5	2.62
2424S	38,1	1.50	2-12	100,8	3.97	79,2	3.12

**90° ORS/Split Flange
(Code 62)**

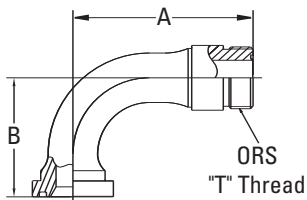

Part No. FF6062T(Size)

Dash Size	Tube O.D.		Thread T	A Ref		B Ref	
	mm	in		mm	in	mm	in
1616S	25,4	1.00	1 ⁷ / ₁₆ -12	105,9	4.17	70,1	2.76

**90° ORS/Split Flange
(Code 62)**

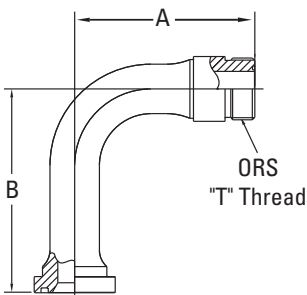

Part No. FF6063T(Size)

Dash Size	Tube O.D.		Thread T	A Ref		B Ref	
	mm	in		mm	in	mm	in
1616S	25,4	1.00	1 ⁷ / ₁₆ -12	105,9	4.17	119,9	4.72

**90° ORS/Split Flange
(Code 62)**

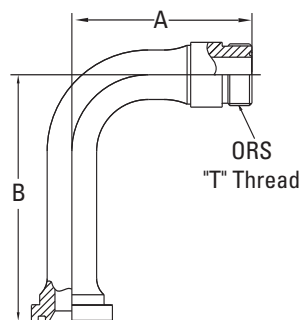

Part No. FF6064T(Size)

Dash Size	Tube O.D.		Thread T	A		B	
	mm	in		mm	in	mm	in
1616S	25,4	1.00	1 ⁷ / ₁₆ -12	105,9	4.17	144,8	5.70

SPECIALTY & TRUCK HOSE
 LOW & MEDIUM PRESSURE HOSE
 HIGH PRESSURE HOSE
 HOSE FITTINGS
 ADAPTERS & TUBE FITTINGS
 ACCESSORIES & ASSEMBLY INSTRUCTIONS
 HOSE ASSEMBLY EQUIPMENT
 APPENDICES

**90° ORS/Split Flange
(Code 62)**

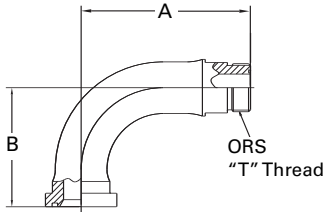

Part No. FF6071T(Size)

Dash Size	Tube O.D.		Thread T	A		B	
	mm	in		mm	in	mm	in
1620S	25,4	1.00	1 ⁷ / ₁₆ -12	128,0	5.04	89,9	3.54

**90° ORS/Split Flange
(Code 62)**

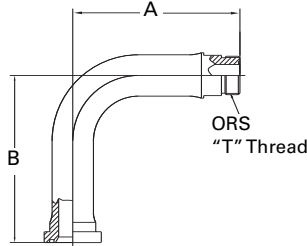

Part No. FF6072T(Size)

Dash Size	Tube O.D.		Thread T	A		B	
	mm	in		mm	in	mm	in
1620S	25,4	1.00	1 ⁷ / ₁₆ -12	158,0	6.22	158,0	6.22

**100° ORS/Split Flange
(Code 62)**

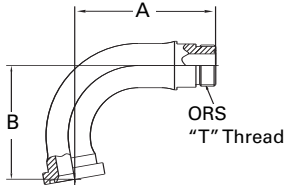

Part No. FF6073T(Size)

Dash Size	Tube O.D.		Thread T	A		B	
	mm	in		mm	in	mm	in
1620S	25,4	1.00	1 ⁷ / ₁₆ -12	124,5	4.90	100,3	3.95

**ORS/Split Flange
(Code 62)**

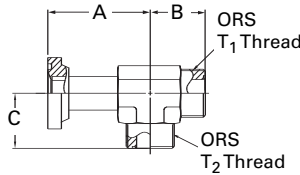

Part No. FF2522T(Size)

Dash Size	Tube O.D.		Thread T1	Thread T2	A		B		C	
	mm	in			mm	in	mm	in	mm	in
0812S	12,7	0.50	1 ³ / ₁₆ -16	1 ³ / ₁₆ -16	41,1	1.62	27,9	1.10	27,9	1.10
1616S	25,4	1.00	1 ⁷ / ₁₆ -12	1 ⁷ / ₁₆ -12	78,7	3.10	41,6	1.64	41,6	1.64
1620S	25,4	1.00	1 ⁷ / ₁₆ -12	1 ⁷ / ₁₆ -12	77,5	3.05	41,6	1.64	41,6	1.64

SAE Split Flange to 37° Flare

**Split Flange/
37° Flare SAE
Standard Pressure
Series (Code 61)**

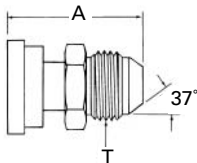

Part No. 500025-(Dash size) (mates with 449-74446 flanges) **The performance rating of these adapters is the lower of the two terminal ends. These adapters are rated to JIC pressures as specified in SAE J514.**

Dash Size	Split Flange Size	Tube O.D.		Thread T	A	
		mm	in		mm	in
8S	1/2	12,7	0.50	3/4-16	42,2	1.66
12S	3/4	19,0	0.75	1 ¹ / ₁₆ -12	48,5	1.91
12-8S	3/4	12,7	0.50	3/4-16	51,6	2.03
16-10S	1	16,0	0.63	7/8-14	47,2	1.86
16-12S	1	19,0	0.75	1 ¹ / ₁₆ -12	58,4	2.30
16S	1	25,4	1.00	1 ⁵ / ₁₆ -12	51,1	2.01
20-16S	1 ¹ / ₄	25,4	1.00	1 ⁵ / ₁₆ -12	59,7	2.35
20-24S	1 ¹ / ₄	38,1	1.50	1 ⁷ / ₈ -12	67,0	2.64
20S	1 ¹ / ₄	31,7	1.25	1 ⁵ / ₈ -12	62,5	2.46
24S	1 ¹ / ₂	38,1	1.50	1 ⁷ / ₈ -12	68,8	2.71
24-16S	1 ¹ / ₂	25,4	1.00	1 ⁵ / ₁₆ -12	61,2	2.41
24-20S	1 ¹ / ₂	31,7	1.25	1 ⁵ / ₈ -12	62,5	2.46
32-16S	2	25,4	1.00	1 ⁵ / ₁₆ -12	58,9	2.32
32-20S	2	31,7	1.25	1 ⁵ / ₈ -12	64,0	2.52
32-24S	2	38,1	1.50	1 ⁷ / ₈ -12	68,8	2.71
32S	2	50,8	2.00	2 ¹ / ₂ -12	78,2	3.08

Split flange/37° flare SAE standard pressure series (Code 61)

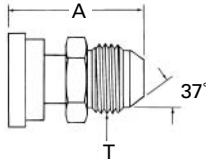

Part No. FF5239-(Dash size) (mates with 449-74446 flanges) **The performance rating of these adapters is the lower of the two terminal ends. These adapters are rated to JIC pressures as specified in SAE J514.**

Dash Size	Split Flange Size	Tube O.D.		Thread T	A	
		mm	in		mm	in
1212S	3/4	19,0	0.75	1 ¹ / ₁₆ -12	80,5	3.17
1616S	1	25,4	1.00	1 ⁵ / ₁₆ -12	95,5	3.76
2020S	1 ¹ / ₄	31,7	1.25	1 ⁵ / ₈ -12	97,5	3.84
2424S	1 ¹ / ₂	38,1	1.50	1 ⁷ / ₈ -12	118,6	4.67
3232S	2	50,8	2.00	2 ¹ / ₂ -12	143,0	5.63

Split Flange/ 37° Flare SAE Standard Pressure Series (Code 62)

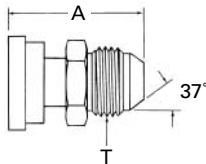

Part No. FF5541-(Dash size) (mates with FC3425- size-449 flanges) **The performance rating of these adapters is the lower of the two terminal ends. These adapters are rated to JIC pressures as specified in SAE J514.**

Dash Size	Split Flange Size	Tube O.D.		Thread T	A	
		mm	in		mm	in
1212S	3/4	19,0	0.75	1 ¹ / ₁₆ -12	80,5	3.17
1616S	1	25,4	1.00	1 ⁵ / ₁₆ -12	95,5	3.76
2016S	1 ¹ / ₄	25,4	1.00	1 ⁵ / ₁₆ -12	95,5	3.76
2020S	1 ¹ / ₄	31,7	1.25	1 ⁵ / ₈ -12	97,5	3.84
2416S	1 ¹ / ₂	25,4	1.00	1 ⁵ / ₁₆ -12	95,5	3.76
2420S	1 ¹ / ₂	31,7	1.25	1 ⁵ / ₈ -12	97,5	3.84
2424S	1 ¹ / ₂	38,1	1.50	1 ⁷ / ₈ -12	118,6	4.67

Split Flange/ 37° Flare SAE Standard Pressure Series (Code 62)

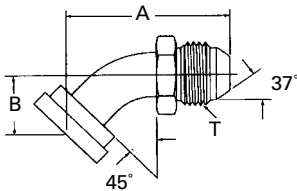

Part No. FF5539-(Dash size) (mates with FC3425-size-449 flanges) **The performance rating of these adapters is the lower of the two terminal ends. These adapters are rated to JIC pressures as specified in SAE J514.**

Dash Size	Split Flange Size	Tube O.D.		Thread T	A		B	
		mm	in		mm	in	mm	in
1612S	1	19,0	0.75	1 ¹ / ₁₆ -12	78,5	3.09	25,4	1.00
1616S	1	25,4	1.00	1 ¹ / ₁₆ -12	91,4	3.60	26,9	1.06
2020S	1 ¹ / ₄	31,7	1.25	1 ⁵ / ₈ -12	98,0	3.86	29,2	1.15
2416S	1 ¹ / ₂	25,4	1.00	1 ⁵ / ₁₆ -12	103,1	4.06	31,8	1.25
2420S	1 ¹ / ₂	31,7	1.25	1 ⁵ / ₈ -12	98,0	3.86	29,2	1.15
2424S	1 ¹ / ₂	38,1	1.50	1 ⁷ / ₈ -12	117,1	4.61	35,8	1.41

SPECIALTY & TRUCK HOSE
 LOW & MEDIUM PRESSURE HOSE
 HIGH PRESSURE HOSE
 HOSE FITTINGS
 ADAPTERS & TUBE FITTINGS
 ACCESSORIES & ASSEMBLY INSTRUCTIONS
 HOSE ASSEMBLY EQUIPMENT
 APPENDICES

Split Flange/37° Flare SAE Standard Pressure Series (Code 61)

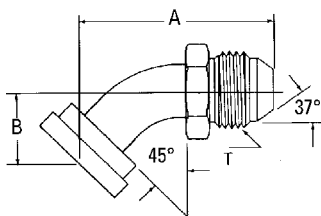

Part No. 500023-(Dash size) (mates with 449-74446 flanges) **The performance rating of these adapters is the lower of the two terminal ends. These adapters are rated to JIC pressures as specified in SAE J514.**

Dash Size	Split Flange Size	Tube O.D.		Thread T	A		B	
		mm	in		mm	in	mm	in
8S	1/2	12,7	0.50	3/4-16	59,4	2.34	25,4	1.00
12-8S	3/4	12,7	0.50	3/4-16	59,4	2.34	25,4	1.00
12S	3/4	19,0	0.75	1 1/16-12	70,3	2.77	25,7	1.01
16-10S	1	16,0	0.63	7/8-14	65,5	2.58	25,4	1.00
16-12S	1	19,0	0.75	1 1/16-12	70,3	2.77	25,7	1.01
16S	1	25,4	1.00	1 5/16-12	77,2	3.04	28,7	1.13
20-12S	1 1/4	19,0	0.75	1 1/16-12	70,3	2.77	25,7	1.01
20-16S	1 1/4	25,4	1.00	1 5/16-12	77,2	3.04	28,7	1.13
20S	1 1/4	31,7	1.25	1 5/8-12	82,3	3.24	28,5	1.12
24-16S	1 1/2	25,4	1.00	1 5/16-12	78,2	3.08	29,7	1.17
24-20S	1 1/2	31,7	1.25	1 5/8-12	82,3	3.24	28,5	1.12
24S	1 1/2	38,1	1.50	1 7/8-12	89,9	3.54	28,5	1.12
24-32S	1 1/2	50,8	2.00	2 1/2-12	99,3	3.91	28,5	1.12
32S	2	50,8	2.00	2 1/2-12	107,7	4.24	31,8	1.25
40-24S	2 1/2	38,1	1.50	1 7/8-12	90,9	3.58	29,7	1.17
40S	2 1/2	63,5	2.50	3-12	131,6	5.18	42,2	1.66

Split Flange/37° Flare SAE Standard Pressure Series (Code 61)

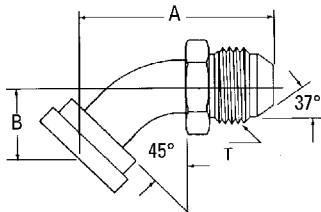

Part No. FF5238-(Dash size) (mates with 449-74446 flanges) **The performance rating of these adapters is the lower of the two terminal ends. These adapters are rated to JIC pressures as specified in SAE J514.**

Dash Size	Split Flange Size	Tube O.D.		Thread T	A		B	
		mm	in		mm	in	mm	in
1212S	3/4	19,0	0.75	1 1/16-12	78,5	3.09	25,4	1.00
1616S	1	25,4	1.00	1 5/16-12	91,4	3.60	26,9	1.06
1620S	1	31,7	1.25	1 5/8-12	92,4	3.64	26,9	1.06
2020S	1 1/4	31,7	1.25	1 5/8-12	98,0	3.86	29,2	1.15
2420S	1 1/2	31,7	1.25	1 5/8-12	98,0	3.86	35,8	1.41
2424S	1 1/2	38,1	1.50	1 7/8-12	117,1	4.61	35,8	1.41
3232S	2	50,8	2.00	2 1/2-12	153,4	6.04	50,8	2.00

Split Flange/37° Flare SAE Standard Pressure Series (Code 61)

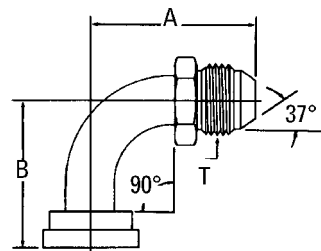

Part No. 500024-(Dash size) (mates with 449-74446 flanges) **The performance rating of these adapters is the lower of the two terminal ends. These adapters are rated to JIC pressures as specified in SAE J514.**

Dash Size	Split Flange Size	Tube O.D.		Thread T	A		B	
		mm	in		mm	in	mm	in
8S	1/2	12,7	0.50	3/4-16	45,2	1.78	41,1	1.62
12S	3/4	19,0	0.75	1 1/16-12	63,2	2.49	54,6	2.15
16-10S	1	16,0	0.63	7/8-14	54,9	2.16	53,9	2.12
16-12S	1	19,0	0.75	1 1/16-12	63,2	2.49	54,6	2.15
16S	1	25,4	1.00	1 5/16-12	70,9	2.79	60,2	2.37
12-8S	3/4	12,7	0.50	3/4-16	45,2	1.78	41,1	1.62
12-10S	3/4	16,0	0.63	7/8-14	60,4	2.38	54,6	2.15
20-12S	1 1/4	19,0	0.75	1 1/16-12	63,2	2.49	54,6	2.15
20-16S	1 1/4	25,4	1.00	1 5/16-12	70,9	2.79	60,2	2.37
20S	1 1/4	31,7	1.25	1 5/8-12	79,7	3.14	63,5	2.50
20-24S	1 1/4	38,1	1.50	1 7/8-12	90,9	3.58	68,3	2.69
24-16S	1 1/2	25,4	1.00	1 5/16-12	70,9	2.79	62,0	2.44
24-20S	1 1/2	31,7	1.25	1 5/8-12	79,7	3.14	63,5	2.50
24S	1 1/2	38,1	1.50	1 7/8-12	90,9	3.58	69,8	2.75
32-24S	2	38,1	1.50	1 7/8-12	90,9	3.58	69,8	2.75
32S	2	50,8	2.00	2 1/2-12	113,3	4.46	82,5	3.25
40-24S	2 1/2	38,1	1.50	1 7/8-12	90,9	3.58	71,4	2.81
40-40S	2 1/2	63,5	2.50	3-12	148,8	5.86	131,8	5.19

**Split Flange/
37° Flare SAE
Standard Pressure
Series (Code 61)**

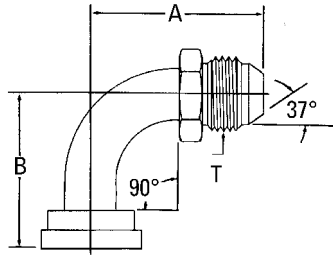

Part No. FF5162-(Dash size) (mates with 449-74446 flanges)
The performance rating of these adapters is the lower of the two terminal ends. These adapters are rated to JIC pressures as specified in SAE J514.

Dash Size	Split Flange Size	Tube O.D.		Thread T	A		B	
		mm	in		mm	in	mm	in
0808S	1/2	12,7	0.50	3/4-16	54,9	2.16	41,1	1.62
1212S	3/4	19,0	0.75	1 1/16-12	71,4	2.81	54,1	2.13
1612S	1	19,0	0.75	1 1/16-12	71,4	2.81	54,1	2.13
1616S	1	25,4	1.00	1 5/16-12	86,6	3.41	60,4	2.38
1620S	1	31,7	1.25	1 5/8-12	87,9	3.46	60,4	2.38
2016S	1 1/4	25,4	1.00	1 5/16-12	86,6	3.41	60,4	2.38
2020S	1 1/4	31,7	1.25	1 5/8-12	94,2	3.71	66,5	2.62
2420S	1 1/2	31,7	1.25	1 5/8-12	94,2	3.71	66,5	2.62
2424S	1 1/2	38,1	1.50	1 7/8-12	110,0	4.33	79,2	3.12
3232S	2	50,8	2.00	2 1/2-12	145,0	5.71	114,3	4.50

**Split Flange/37° Flare
SAE High Pressure
Series (Code 62)**

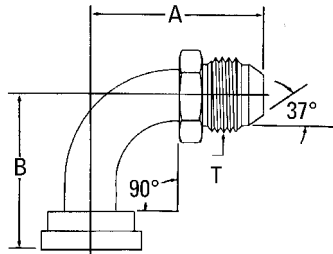

Part No. FF5540-(Dash size) (mates with FC3425 - size-449 flanges)
The performance rating of these adapters is the lower of the two terminal ends. These adapters are rated to JIC pressures as specified in SAE J514.

Dash Size	Split Flange Size	Tube O.D.		Thread T	A		B	
		mm	in		mm	in	mm	in
1612S	1	19,0	0.75	1 1/16-12	71,4	2.81	54,1	2.13
1616S	1	25,4	1.00	1 5/16-12	86,6	3.41	60,4	2.38
2016S	1 1/4	25,4	1.00	1 5/16-12	86,6	3.41	60,4	2.38
2020S	1 1/4	31,7	1.25	1 5/8-12	94,2	3.71	66,5	2.62
2416S	1 1/2	25,4	1.00	1 5/16-12	86,6	3.41	69,8	2.75
2420S	1 1/2	31,7	1.25	1 5/8-12	94,2	3.71	66,5	2.62
2424S	1 1/2	38,1	1.50	1 7/8-12	110,0	4.33	79,2	3.12

SAE Split Flange to SAE Split Flange

**SAE Swivel Flange/
Split Flange SAE
Standard Pressure
Series (Code 61)**

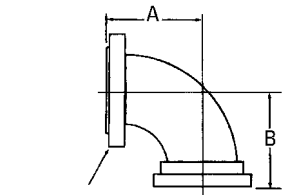

4 Hole
(Threaded)
Swivel Flange

Part No. 504089-(Dash size) (suitable for pressures thru 4 light spiral hose - SAE 100R9)

Dash Size	Flange Size	Shoulder Size	A		B	
			mm	in	mm	in
16S	1	1	52,3	2.06	60,2	2.37
20S	1 1/4	1 1/4	58,7	2.31	63,5	2.50
24S	1 1/2	1 1/2	66,5	2.62	69,8	2.75
32S	2	2	79,2	3.12	82,5	3.25
40S	2 1/2	2 1/2	119,1	4.69	131,8	5.19

**SAE Swivel Flange/
Split Flange (Welded)
SAE Standard
Pressure Series
(Code 61)**

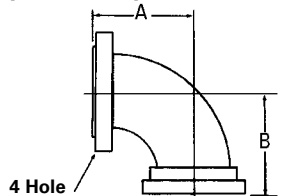

4 Hole
(Threaded)
Swivel Flange

Part No. FF5321-(Dash size) (suitable for pressures thru 4 heavy spiral hose - SAE 100R10)

Dash Size	Flange Size	Shoulder Size	A		B	
			mm	in	mm	in
1616S	1	1	60,4	2.38	60,4	2.38
2020S	1 1/4	1 1/4	66,5	2.62	66,5	2.62
2424S	1 1/2	1 1/2	79,2	3.12	79,2	3.12
3232S	2	2	114,3	4.50	114,3	4.50

Braze & Weld to Split Flange

Braze/Solid Flanged Head SAE Standard Pressure Series (Code 61)

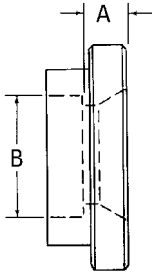

Part No. 71418-(Dash size)

Dash Size	Split Flange Size	Tube O.D.		A		B	
		mm	in	mm	in	mm	in
12-12S	3/4	19,0	0.75	7,9	0.31	19,0	0.75
16-12S	3/4	25,4	1.00	7,9	0.31	25,4	1.00
16-16S	1	25,4	1.00	7,9	0.31	25,4	1.00
16-20S	1 1/4	25,4	1.00	7,9	0.31	25,4	1.00
20-16S	1	31,7	1.25	7,9	0.31	31,8	1.25
20-20S	1 1/4	31,7	1.25	7,9	0.31	31,8	1.25
20-24S	1 1/2	31,7	1.25	7,9	0.31	31,8	1.25
24-20S	1 1/4	38,1	1.50	9,7	0.38	38,1	1.50
24-24S	1 1/2	38,1	1.50	9,7	0.38	38,1	1.50
32-32S	2	50,8	2.00	9,7	0.38	50,8	2.00
40-40S	2 1/2	63,5	2.50	11,2	0.44	63,5	2.50

Weld (Tank Pilot) Solid Flanged Head SAE Standard Pressure Series (Code 61)

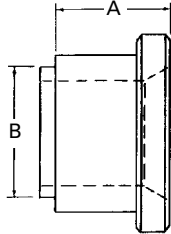

Part No. 71423-(Dash size)

Dash Size	Flange Size	A		B	
		mm	in	mm	in
12S	3/4	27,4	1.08	26,9	1.06
16S	1	27,4	1.08	33,3	1.31
20S	1 1/4	27,4	1.08	36,6	1.44
24S	1 1/2	29,0	1.14	42,9	1.69
32S	2	29,0	1.14	55,6	2.19

Braze/(Flanged Head) SAE Standard Pressures Series (Code 61)

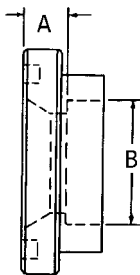

Part No. 4624-(Dash size)

Dash Size	Split Flange Size	Tube O.D.		A		B	
		mm	in	mm	in	mm	in
8-6S	1/2	9,6	0.38	6,4	0.25	9,7	0.38
8S	1/2	12,7	0.50	6,4	0.25	12,7	0.50
12-8S	3/4	12,7	0.50	6,4	0.25	12,7	0.50
12-10S	3/4	16,0	0.63	7,9	0.31	15,7	0.62
12-16S	3/4	25,4	1.00	7,9	0.31	25,4	1.00
12S	3/4	19,0	0.75	7,9	0.31	19,0	0.75
16-10S	1	16,0	0.63	10,4	0.41	15,7	0.62
16-12S	1	19,0	0.75	7,9	0.31	19,0	0.75
16-20S	1	31,7	1.25	7,9	0.31	31,8	1.25
16S	1	25,4	1.00	7,9	0.31	25,4	1.00
20-12S	1 1/4	19,0	0.75	7,9	0.31	19,0	0.75
20-16S	1 1/4	25,4	1.00	7,9	0.31	25,4	1.00
20-24S	1 1/4	38,1	1.50	7,9	0.31	38,1	1.50
20S	1 1/4	31,7	1.25	7,9	0.31	31,8	1.25
24-12S	1 1/2	19,0	0.75	9,7	0.38	19,0	0.75
24-16S	1 1/2	25,4	1.00	9,7	0.38	25,4	1.00
24-20S	1 1/2	31,7	1.25	7,9	0.31	31,8	1.25
24S	1 1/2	38,1	1.50	9,7	0.38	38,1	1.50
32-16S	2	25,4	1.00	7,1	0.28	25,4	1.00
32-20S	2	31,7	1.25	9,7	0.38	31,8	1.25
32-24S	2	38,1	1.50	9,7	0.38	38,1	1.50
32S	2	50,8	2.00	9,7	0.38	50,8	2.00
40-32S	2 1/2	50,8	2.00	11,2	0.44	50,8	2.00

SPECIALTY & TRUCK HOSE

LOW & MEDIUM PRESSURE HOSE

HIGH PRESSURE HOSE

HOSE FITTINGS

ADAPTERS & TUBE FITTINGS

ACCESSORIES & ASSEMBLY INSTRUCTIONS

HOSE ASSEMBLY EQUIPMENT

APPENDICES

**Buttweld (Pipe)/
Solid Flanged Head
SAE Standard
Pressure Series
(Code 61)**

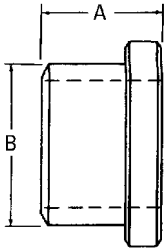

Part No. 71416-(Dash size)

Dash Size	Flange Size	A		B	
		mm	in	mm	in
16S	1	27,4	1.08	33,6	1.32
20S	1 ¹ / ₄	27,4	1.08	42,2	1.66
24S	1 ¹ / ₂	29,0	1.14	48,3	1.90
32S	2	29,0	1.14	60,4	2.38

**Saddle Weld
(Pipe)/Solid Flanged
Head SAE Standard
Pressure Series
(Code 61)**

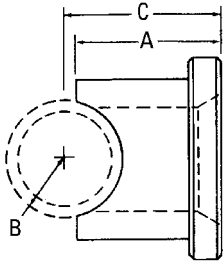

Part No. 71422-(Dash size)

Dash Size	Flange Size	A		B		C	
		mm	in	mm	in	mm	in
16-16S	1	30,7	1.21	16,8	0.66	38,6	1.52
20-20S	1 ¹ / ₄	32,3	1.27	21,0	0.83	44,9	1.77
24-24S	1 ¹ / ₂	36,1	1.42	24,1	0.95	49,8	1.96
24-32S	2	39,6	1.56	24,1	0.95	47,2	1.86

**Braze/(Flanged Head)
SAE High Pressure
Series (Code 62)**

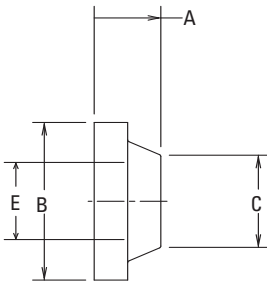

Part No. FC1102-(Dash size)

Dash Size	Tube O.D.		A		B		C		E	
	mm	in	mm	in	mm	in	mm	in	mm	in
0808S	12,7	0.50	15,7	0.62	31,7	1.25	17,8	0.70	9,9	0.39
1208S	12,7	0.50	15,7	0.62	41,4	1.63	24,1	0.95	9,9	0.39
1212S	19,0	0.75	17,5	0.69	41,4	1.63	24,1	0.95	14,7	0.58
1612S	25,4	1.00	17,5	0.69	47,7	1.88	31,5	1.24	14,7	0.58
1616S	25,4	1.00	15,7	0.62	47,7	1.88	31,5	1.24	20,8	0.82
2012S	31,7	1.25	15,7	0.62	54,1	2.13	38,3	1.51	19,0	0.75
2016S	31,7	1.25	15,7	0.62	54,1	2.13	38,3	1.51	20,8	0.82
2020S	31,7	1.25	15,7	0.62	54,1	2.13	38,1	1.50	26,7	1.05
2416S	38,1	1.50	15,7	0.62	63,5	2.50	46,5	1.83	20,8	0.82
2424S	38,1	1.50	19,0	0.75	63,5	2.50	46,5	1.83	32,2	1.27
3220S	50,8	2.00	15,7	0.62	79,5	3.13	63,0	2.48	26,7	1.05
3224S	50,8	2.00	19,0	0.75	79,5	3.13	63,0	2.48	32,2	1.27
3232S	50,8	2.00	28,4	1.12	79,5	3.13	58,7	2.31	43,7	1.72

**Braze/Solid Flanged
Head SAE High
Pressure Series
(Code 62)**

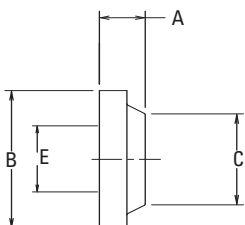

Part No. FC1132-(Dash size)

Dash Size	Tube O.D.		A		B		C		E	
	mm	in	mm	in	mm	in	mm	in	mm	in
1212	19,0	0.75	17,5	0.69	41,4	1.63	24,1	0.95	14,7	0.58
1616	25,4	1.00	15,7	0.62	47,7	1.88	31,5	1.24	20,5	0.81
2020	31,7	1.25	15,7	0.62	54,1	2.13	38,1	1.50	26,7	1.05

SPECIALTY & TRUCK HOSE
LOW & MEDIUM PRESSURE HOSE
HIGH PRESSURE HOSE
HOSE FITTINGS
ADAPTERS & TUBE FITTINGS
ACCESSORIES & ASSEMBLY INSTRUCTIONS
HOSE ASSEMBLY EQUIPMENT
APPENDICES

Braze & Weld to 37° Flare

Weld Port/37° Flare

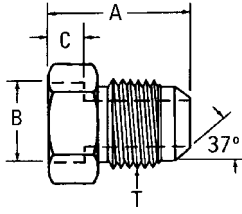

Part No. 202232-(Dash size)

Dash Size	Tube O.D.		Thread T	A		B		C	
	mm	in		mm	in	mm	in	mm	in
1/4-8S	6,3	0.25	3/4-16	30,5	1.20	14,2	0.56	9,7	0.38
1/2-12S	12,7	0.50	1 1/16-12	39,1	1.54	21,8	0.86	12,7	0.50
1-20S	25,4	1.00	1 5/8-12	46,0	1.81	34,0	1.34	16,0	0.63

Braze Port/37° Flare

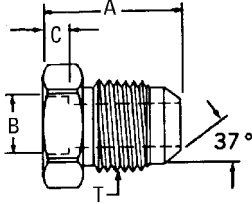

Part No. 73014-(Dash size)

Dash Size	Tube O.D.		Thread T	A		B		C	
	mm	in		mm	in	mm	in	mm	in
4S	6,3	0.25	7/16-20	18,8	0.74	6,4	0.25	4,0	0.16
5S	7,9	0.31	1/2-20	20,3	0.80	7,9	0.31	4,0	0.16
6S	9,6	0.38	9/16-18	20,6	0.81	9,7	0.38	4,0	0.16
8-6S	12,7	0.50	9/16-18	21,3	0.84	12,7	0.50	4,0	0.16
8S	12,7	0.50	3/4-16	23,9	0.94	12,7	0.50	4,0	0.16
10S	16,0	0.63	7/8-14	27,2	1.07	15,7	0.62	4,0	0.16
10-16S	16,0	0.63	1 5/16-12	32,8	1.29	15,7	0.62	4,0	0.16
12-10S	19,0	0.75	7/8-14	28,7	1.13	19,0	0.75	6,4	0.25
12S	19,0	0.75	1 1/16-12	31,5	1.24	19,0	0.75	6,4	0.25
14S	22,3	0.88	1 3/16-12	32,0	1.26	22,4	0.88	6,4	0.25
16S	25,4	1.00	1 5/16-12	32,8	1.29	25,4	1.00	6,4	0.25
16-12S	25,4	1.00	1 1/16-12	31,5	1.24	25,4	1.00	6,4	0.25
16-20S	25,4	1.00	1 5/8-12	35,6	1.40	25,4	1.00	6,4	0.25
20S	31,7	1.25	1 5/8-12	35,6	1.40	31,8	1.25	6,4	0.25
20-16S	31,7	1.25	1 5/16-12	32,8	1.29	31,8	1.25	6,4	0.25
24-16S	38,1	1.50	1 5/16-12	35,8	1.41	38,1	1.50	6,4	0.25
24S	38,1	1.50	1 7/8-12	40,1	1.58	38,1	1.50	6,4	0.25
24-20S	38,1	1.50	1 5/8-12	37,1	1.46	38,1	1.50	6,4	0.25
24-32S	38,1	1.50	2 1/2-12	49,5	1.95	38,1	1.50	6,4	0.25
32S	50,8	2.00	2 1/2-12	49,8	1.96	50,8	2.00	6,4	0.25
40S	63,5	2.50	3-12	47,2	1.86	63,5	2.50	6,4	0.25

SPECIALTY & TRUCK HOSE

LOW & MEDIUM PRESSURE HOSE

HIGH PRESSURE HOSE

HOSE FITTINGS

ADAPTERS & TUBE FITTINGS

ACCESSORIES & ASSEMBLY INSTRUCTIONS

HOSE ASSEMBLY EQUIPMENT

APPENDICES

SAE Flareless to 37° Union

Male SAE Flareless/ 37° Flare*

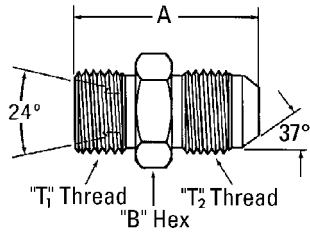

Part No. FF1315-(Dash size)

Dash Size	Tube O.D.		Thread T1	Thread T2	A		B	
	mm	in			mm	in	mm	in
0404S	6,3	0.25	7/16-20	7/16-20	31,0	1.22	12,7	0.50
0604S	9,6	0.38	9/16-18	7/16-20	32,3	1.27	15,7	0.62
0606S	9,6	0.38	9/16-18	9/16-18	32,5	1.28	15,7	0.62
0806S	12,7	0.50	3/4-16	9/16-18	34,8	1.37	20,6	0.81
0808S	12,7	0.50	3/4-16	3/4-16	37,3	1.47	20,6	0.81
1008S	16,0	0.63	7/8-14	3/4-16	40,4	1.59	23,9	0.94
1010S	16,0	0.63	7/8-14	7/8-14	42,9	1.69	23,9	0.94
1212S	19,0	0.75	1 1/16-12	1 1/16-12	49,0	1.93	28,5	1.12
1412S	22,3	0.88	1 3/16-12	1 1/16-12	49,0	1.93	31,8	1.25
1616S	25,4	1.00	1 5/16-12	1 5/16-12	50,3	1.98	35,1	1.38

Flareless Tube Nut*

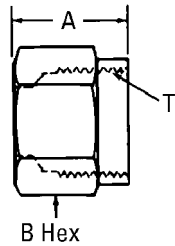

Part No. 210294-(Dash size)

Use with FF1315-(Dash size) Body Only

(Ref. SAE 080110)

Dash Size	Tube O.D.		Thread T	A		B	
	mm	in		mm	in	mm	in
4S	6,3	0.25	7/16-20	17,8	0.70	14,2	0.56
6S	9,6	0.38	9/16-18	19,0	0.75	17,6	0.69
8S	12,7	0.50	3/4-16	21,3	0.84	22,4	0.88
10S	16,0	0.63	7/8-14	23,4	0.92	25,4	1.00
12S	19,0	0.75	1 1/16-12	24,6	0.97	31,8	1.25
14S	22,3	0.88	1 3/16-12	25,4	1.00	35,1	1.38
16S	25,4	1.00	1 5/16-12	26,7	1.05	38,1	1.50

Ferrule-Style A* (for Flareless Tube Fittings)

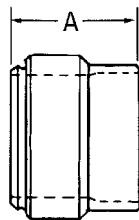

Part No. FF9173-(Dash size)

Use with FF1315-(Dash size) Body Only

(Ref. SAE 080115A)

Dash Size	Tube O.D.		A	
	mm	in	mm	in
04S	6,3	0.25	9,1	0.36
06S	9,6	0.38	9,9	0.39
08S	12,7	0.50	10,9	0.43
10S	16,0	0.63	11,2	0.44
12S	19,0	0.75	11,9	0.47
14S	22,3	0.88	12,2	0.48
16S	25,4	1.00	12,2	0.48

*NOTE: All three components (adapter FF1315, tube nut 210294 and ferrule FF9173) required for assembly. Order by Part Number FF1316-(Dash size) for complete assembly.

Versil-Flare Flare and Flareless

Versil-Flare Flareless Tube Nut

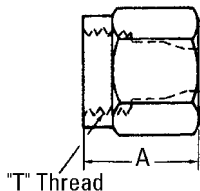

Part No. FC2875-(Dash size) Use with FF9605-(Dash size) Ferrule Only

Dash Size	Tube O.D.		Thread T	A	
	mm	in		mm	in
03S	4,8	0.19	3/8-24	20,1	0.79
04S	6,3	0.25	7/16-20	20,8	0.82
05S	7,9	0.31	1/2-20	20,8	0.82
06S	9,6	0.38	9/16-18	21,8	0.86
08S	12,7	0.50	3/4-16	27,4	1.08
10S	16,0	0.63	7/8-14	28,5	1.12
12S	19,0	0.75	1 1/16-12	34,5	1.36
16S	25,4	1.00	1 5/16-12	35,6	1.40
20S	31,7	1.25	1 5/8-12	45,7	1.80
24S	38,1	1.50	1 7/8-12	46,7	1.84
32S	50,8	2.00	2 1/2-12	55,9	2.20

Versil-Flare Flareless Tube Ferrule

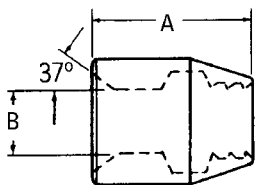

Part No. FF9605-(Dash size) Use with FC2875-(Dash size) Nut Only

Dash Size	Tube O.D.		A		B	
	mm	in	mm	in	mm	in
03S	4,8	0.19	10,2	0.40	4,8	0.19
04S	6,3	0.25	10,7	0.42	6,4	0.25
05S	7,9	0.31	10,7	0.42	7,9	0.31
06S	9,6	0.38	11,7	0.46	9,7	0.38
08S	12,7	0.50	14,5	0.57	12,7	0.50
10S	16,0	0.63	14,7	0.58	15,7	0.62
12S	19,0	0.75	17,8	0.70	19,0	0.75
16S	25,4	1.00	17,8	0.70	25,4	1.00
20S	31,7	1.25	25,4	1.00	31,8	1.25
24S	38,1	1.50	25,4	1.00	38,1	1.50
32S	50,8	2.00	29,7	1.17	50,8	2.00

Versil-Flare SAE 37° Flared Style "B" Nut

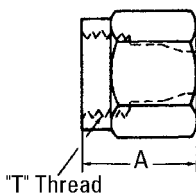

Part No. 1290-(Dash size) (Ref. SAE 070110) Use with 900605 Tube Sleeve Only

Dash Size	Tube O.D.		Thread T	A		B	
	mm	in		mm	in	mm	in
3S	4,8	0.19	3/8-24	15,2	0.60	11,2	0.44
4S	6,3	0.25	7/16-20	15,7	0.62	14,2	0.56
5S	7,9	0.31	1/2-20	17,0	0.67	15,7	0.62
6S	9,6	0.38	9/16-18	18,3	0.72	17,6	0.69
8S	12,7	0.50	3/4-16	21,3	0.84	22,4	0.88
10S	16,0	0.63	7/8-14	24,6	(0.97)	25,4	1.00
12S	19,0	0.75	1 1/16-12	25,9	1.02	31,8	1.25
14S	22,3	0.88	1 3/16-12	27,4	1.08	35,1	1.38
16S	25,4	1.00	1 5/16-12	28,5	1.12	38,1	1.50
20S	31,7	1.25	1 5/8-12	31,0	1.22	50,8	2.00
24S	38,1	1.50	1 7/8-12	35,8	1.41	57,2	2.25
32S	50,8	2.00	2 1/2-12	40,4	1.59	73,1	2.88

Also available in stainless steel as part no. 259-1290. See pg. 281 for more information.

SPECIALTY &
TRUCK HOSE

LOW & MEDIUM
PRESSURE HOSE

HIGH PRESSURE HOSE

HOSE FITTINGS

ADAPTERS &
TUBE FITTINGS

ACCESSORIES &
ASSEMBLY INSTRUCTIONS

HOSE ASSEMBLY
EQUIPMENT

APPENDICES

Versil-Flare
SAE 37° Flared Sleeve

Part No. 900605-(Dash size) (Ref. SAE 070115)
Use with 1290 Short Nut Only

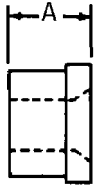

Dash Size	Tube O.D.		A	
	mm	in	mm	in
3S	4,8	0.19	8,6	0.34
4S	6,3	0.25	10,4	0.41
5S	7,9	0.31	11,2	0.44
6S	9,6	0.38	12,7	0.50
8S	12,7	0.50	14,2	0.56
10S	16,0	0.63	16,8	0.66
12S	19,0	0.75	17,6	0.69
14S	22,3	0.88	19,3	0.76
16S	25,4	1.00	19,8	0.78
20S	31,7	1.25	23,1	0.91
24S	38,1	1.50	28,5	1.12
32S	50,8	2.00	30,3	1.19

*Also available in stainless steel as part no. 259-900605.
See pg. 281 for more information.*

Specials

**External Pipe/
30° Flare**

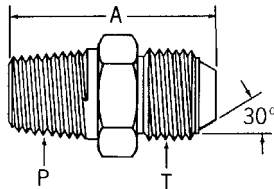

Part No. 2004-(Dash size)

Dash Size	Tube O.D.		Thread P	Thread T	A	
	mm	in			mm	in
12-16S	25,4	1.00	3/4-14	1 5/16-14	46,7	1.84
16-16S	25,4	1.00	1-11 1/2	1 5/16-14	51,6	2.03
20-20S	31,7	1.25	1 1/4-11 1/2	1 5/8-14	59,4	2.34

**42° Inverted Flare/
37° Flare**

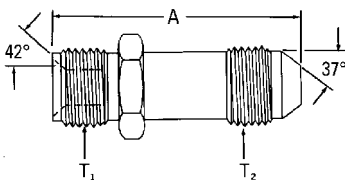

Part No. 202124-(Dash size)
Part No. FF1327-(Dash size) Long*

Dash Size	Tube O.D.		Thread T1	Thread T2	A	
	mm	in			mm	in
3-3S	4,8	0.19	3/8-24	3/8-24	27,2	1.07
3-4S	6,3	0.25	3/8-24	7/16-20	29,0	1.14
0304S*	6,3	0.25	3/8-24	7/16-20	61,0	2.40
4-4S	6,3	0.25	7/16-24	7/16-20	29,0	1.14
0404S*	6,3	0.25	7/16-24	7/16-20	61,0	2.40
0405S*	7,9	0.31	7/16-24	1/2-20	61,0	2.40
5-4S	6,3	0.25	1/2-20	7/16-20	29,5	1.16

**Length required to insert adapter at installation.*

**42° Inverted Flare/
45° Flare**

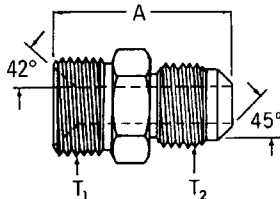

Part No. 200001-(Dash size)

Dash Size	Tube O.D.		Thread T1	Thread T2	A	
	mm	in			mm	in
4-4B	6,3	0.25	7/16-24	7/16-20	27,7	1.09
4-5B	7,9	0.31	7/16-24	1/2-20	28,5	1.12
4-6B	9,6	0.38	7/16-24	5/8-18	30,7	1.21
5-4B	6,3	0.25	1/2-20	7/16-20	27,9	1.10
5-5B	7,9	0.31	1/2-20	1/2-20	29,5	1.16
5-6B	9,6	0.38	1/2-20	5/8-18	31,8	1.25
6-5B	7,9	0.31	5/8-18	1/2-20	31,0	1.22
6-6B	9,6	0.38	5/8-18	5/8-18	32,5	1.28
7-6B	9,6	0.38	1 1/16-18	5/8-18	36,3	1.43
7-8B	12,7	0.50	1 1/16-18	3/4-16	39,6	1.56
8-6B	9,6	0.38	3/4-18	5/8-18	36,3	1.43
8-8B	12,7	0.50	3/4-18	3/4-16	39,6	1.56
10-10B	16,0	0.63	7/8-18	7/8-14	44,7	1.76
12-12B	19,0	0.75	1 1/16-16	1 1/16-14	52,0	2.05

SPECIALTY & TRUCK HOSE
LOW & MEDIUM PRESSURE HOSE
HIGH PRESSURE HOSE
HOSE FITTINGS
ADAPTERS & TUBE FITTINGS
ACCESSORIES & ASSEMBLY INSTRUCTIONS
HOSE ASSEMBLY EQUIPMENT
APPENDICES

30° Inverted Flare/ 37° Flare

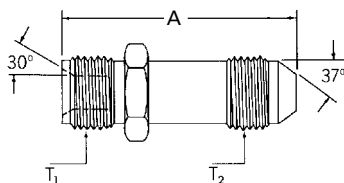

Part No. FF1353-(Dash size) Part No. FF1354-(Dash size) Long†

Dash Size	Tube O.D.		Thread T1	Thread T2	A	
	mm	in			mm	in
0404S	6,3	0.25	7/16-20	7/16-20	33,8	1.33
0404S†	6,3	0.25	7/16-20	7/16-20	63,5	2.50

Restrictor† Male Pipe/ Female Pipe

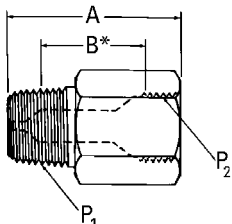

Part No. FF1980-(Dash size)

Dash Size	Tube O.D.		Thread P1	Thread P2	A		B*	
	mm	in			mm	in	mm	in
0404	6,3	0.25	1/4-18	1/4-18	35,3	1.39	16,2	0.64
0606	9,6	0.38	3/8-18	3/8-18	36,6	1.44	17,6	0.69
0808	12,7	0.50	1/2-14	1/2-14	47,5	1.87	22,1	0.87

Restrictor† 37° Male Flare/ 37° Female

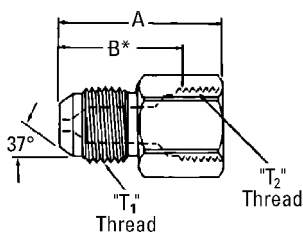

Part No. FF1981-(Dash size)

Dash Size	Tube O.D.		Thread P1	Thread P2	A		B*	
	mm	in			mm	in	mm	in
0404	6,3	0.25	7/16-20	7/16-20	28,9	1.14	17,5	0.69
0606	9,6	0.38	9/16-18	9/16-18	30,2	1.19	18,3	0.72
0808	12,7	0.50	3/4-16	3/4-16	34,5	1.36	25,6	1.01

*Length required to insert adapter at installation.

†Ordering Information: Eaton Restrictor Adapters are available in orifice sizes from .06 to .25 inches. When ordering restrictor adapters, it is important to indicate the drill size required.

For example: For a .125 drill size in FF1980-0404 adapter, order as FF1980-125-0404. If you indicate the desired orifice size in inches, the appropriate 3 digit number will be assigned.

Metric to 37° Flare

Metric 24° (DIN 3901/3902 I.Rh)/ 37° Flare

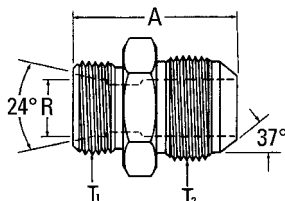

Part No. 15.063-(Dash size)

Dash Size	Tube O.D.		Thread T1	Thread T2	A		Rø	
	mm	in			mm	in	mm	in
6-4	6,4	0.25	M12 x 1.5	7/16-20	31,0	1.22	6,0	0.24
8-6	9,7	0.38	M14 x 1.5	9/16-18	31,0	1.22	8,0	0.31
10-8	12,7	0.50	M16 x 1.5	3/4-16	34,5	1.36	10,0	0.39
12-8	12,7	0.50	M18 x 1.5	3/4-16	34,5	1.36	12,0	0.47
15-10	16,0	0.63	M22 x 1.5	7/8-14	39,1	1.54	15,0	0.59
18-12	19,0	0.75	M26 x 1.5	1 1/16-12	42,9	1.69	18,0	0.71
22-16	25,4	1.00	M30 x 2	1 5/16-12	46,0	1.81	22,0	0.87
28-20	31,8	1.25	M36 x 2	1 5/8-12	47,5	1.87	28,0	1.10
35-24	38,1	1.50	M45 x 2	1 7/8-12	52,6	2.07	35,0	1.38
42-32	50,8	2.00	M52 x 2	2 1/2-12	61,0	2.40	42,0	1.65

Metric 24° (DIN 3901/3902 s.Rh)/ 37° Flare

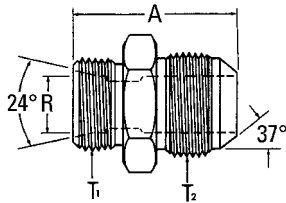

Part No. 15.147-(Dash size)

Dash Size	Tube O.D.		Thread T1	Thread T2	A		Rø	
	mm	in			mm	in	mm	in
6-6	9,7	0.38	M14 x 1.5	⁹ / ₁₆ -18	33,0	1.30	6,0	0.24
10-8	12,7	0.50	M18 x 1.5	³ / ₄ -16	35,6	1.40	10,0	0.39
14-10	16,0	0.63	M22 x 1.5	⁷ / ₈ -14	40,4	1.59	14,0	0.55
16-12	19,0	0.75	M24 x 1.5	¹ / ₁₆ -12	44,9	1.77	16,0	0.63
20-16	25,4	1.00	M30 x 2	¹ / ₂ -12	48,0	1.89	20,0	0.79
25-20	31,8	1.25	M36 x 2	⁵ / ₈ -12	51,6	2.03	25,0	0.98
30-24	38,1	1.50	M42 x 2	¹ / ₂ -12	56,4	2.22	30,0	1.18
38-32	50,8	2.00	M52 x 2	¹ / ₂ -12	67,0	2.64	38,0	1.50

Metric 60° (DIN 7631)/37° Flare

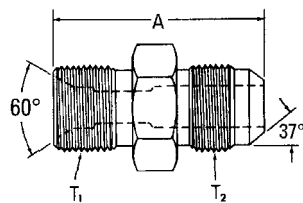

Part No. 15.117-(Dash size)

Dash Size	Tube O.D.		Thread T1	Thread T2	A	
	mm	in			mm	in
4-4	6,4	0.25	M12 x 1.5	⁷ / ₁₆ -20	31,0	1.22
6-6	9,7	0.38	M14 x 1.5	⁹ / ₁₆ -18	31,0	1.22
8-6	9,7	0.38	M16 x 1.5	⁹ / ₁₆ -18	32,0	1.26
8-8	12,7	0.50	M16 x 1.5	³ / ₄ -16	34,5	1.36
10-8	12,7	0.50	M18 x 1.5	³ / ₄ -16	34,5	1.36
13-10	16,0	0.63	M22 x 1.5	⁷ / ₈ -14	38,6	1.52
16-12	19,0	0.75	M26 x 1.5	¹ / ₁₆ -12	42,9	1.69
25-20	31,8	1.25	M38 x 1.5	¹ / ₂ -12	47,5	1.87
32-24	38,1	1.50	M45 x 1.5	¹ / ₂ -12	52,6	2.07
40-32	50,8	2.00	M52 x 1.5	¹ / ₂ -12	61,0	2.40

Metric 24° (DIN 3901/3902 s.Rh)/ 37° Flare

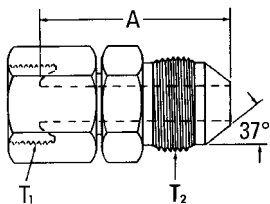

Part No. 15.164-(Dash size)

Dash Size	Tube O.D.		Thread T1	Thread T2	A	
	mm	in			mm	in
6-6	9,7	0.38	M14 x 1.5	⁹ / ₁₆ -18	35,1	1.38
10-8	12,7	0.50	M18 x 1.5	³ / ₄ -16	38,1	1.50
14-10	16,0	0.63	M22 x 1.5	⁷ / ₈ -14	40,9	1.61
16-12	19,0	0.75	M24 x 1.5	¹ / ₁₆ -12	43,4	1.71
20-16	25,4	1.00	M30 x 2	¹ / ₁₆ -12	47,0	1.85
30-24	38,1	1.50	M42 x 2	¹ / ₂ -12	53,9	2.12
38-32	50,8	2.00	M52 x 2	¹ / ₂ -12	62,5	2.46

Metric 24° (DIN 3901/3902 I.Rh)/ 37° Flare

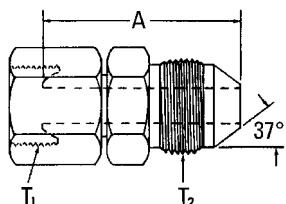

PartNo. 15.163-(Dash size)

Dash Size	Tube O.D.		Thread T1	Thread T2	A	
	mm	in			mm	in
4-4†	6,4	0.25	M12 x 1.5	⁷ / ₁₆ -20	34,5	1.36
6-6†	9,7	0.38	M14 x 1.5	⁹ / ₁₆ -18	34,5	1.36
8-6†	9,7	0.38	M16 x 1.5	⁹ / ₁₆ -18	35,6	1.40
8-8†	12,7	0.50	M16 x 1.5	³ / ₄ -16	38,1	1.50
10-8†	12,7	0.50	M18 x 1.5	³ / ₄ -16	38,1	1.50
13-10†	16,0	0.63	M22 x 1.5	⁷ / ₈ -14	40,9	1.61
16-12†	19,0	0.75	M26 x 1.5	¹ / ₁₆ -12	47,5	1.87
22-16	25,4	1.00	M30 x 2	¹ / ₂ -12	49,0	1.93
28-20	31,8	1.25	M36 x 2	⁵ / ₈ -12	51,6	2.03
35-24	38,1	1.50	M45 x 2	¹ / ₂ -12	53,6	2.11
42-32	50,8	2.00	M52 x 2	¹ / ₂ -12	62,5	2.46

†Universal fitting also mates with 60° DIN 7631/7647 connections.

SPECIALTY & TRUCK HOSE
 LOW & MEDIUM PRESSURE HOSE
 HIGH PRESSURE HOSE
 HOSE FITTINGS
 ADAPTERS & TUBE FITTINGS
 ACCESSORIES & ASSEMBLY INSTRUCTIONS
 HOSE ASSEMBLY EQUIPMENT
 APPENDICES

Metric 60° (DIN 7631/7647)/37° Flare

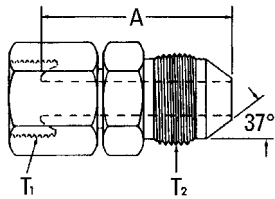

Part No. 15.165-(Dash size)

Dash Size	Tube O.D.		Thread T1	Thread T2	A	
	mm	in			mm	in
20-16	25,4	1.00	M30 x 1.5	1 ⁵ / ₁₆ -12	46,0	1.81
25-20	31,7	1.25	M38 x 1.5	1 ⁵ / ₈ -12	49,5	1.95
32-24	38,1	1.50	M45 x 1.5	1 ⁷ / ₈ -12	52,6	2.07
40-32	50,8	2.00	M52 x 1.5	2 ¹ / ₂ -12	61,0	2.40

SAE 37° Male/Metric Male

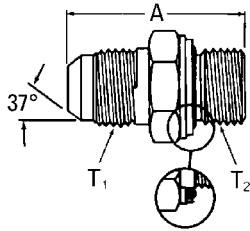

GG108-NP(Size)-(Size)

Dash Size	Tube O.D.		Thread T1	Thread T2	A	
	mm	in			mm	in
04-10	6,4	0.25	7/16-20	M10 x 1	29,0	1.14
04-12	6,4	0.25	7/16-20	M12 x 1.5	33,0	1.30
05-10	7,9	0.31	1/2-20	M10 x 1	29,0	1.14
06-14	9,7	0.38	9/16-18	M14 x 1.5	34,0	1.34
06-16	9,7	0.38	9/16-18	M16 x 1.5	34,0	1.34
08-16	12,7	0.50	3/4-16	M16 x 1.5	37,1	1.46
08-18	12,7	0.50	3/4-16	M18 x 1.5	37,6	1.48
10-18	16,0	0.63	7/8-14	M18 x 1.5	40,1	1.58
10-20	16,0	0.63	7/8-14	M20 x 1.5	42,9	1.69
10-22	16,0	0.63	7/8-14	M22 x 1.5	42,9	1.69
12-22	19,0	0.75	1 ¹ / ₁₆ -12	M22 x 1.5	46,5	1.83
12-27	19,0	0.75	1 ¹ / ₁₆ -12	M27 x 2	49,5	1.95
16-33	25,4	1.00	1 ⁵ / ₁₆ -12	M33 x 2	53,6	2.11

90° Adjustable Elbow SAE 37° Male/Metric Male

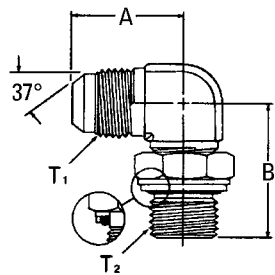

GG308-NP(Size)-(Size)

Dash Size	Tube O.D.		Thread T1	Thread T2	A		B	
	mm	in			mm	in	mm	in
04-10	6,4	0.25	7/16-20	M10 x 1	22,6	0.89	25,9	1.02
04-12	6,4	0.25	7/16-20	M12 x 1.5	26,9	1.06	31,5	1.24
06-16	9,7	0.38	9/16-18	M16 x 1.5	28,5	1.12	36,6	1.44
08-16	12,7	0.50	3/4-16	M16 x 1.5	31,5	1.24	36,6	1.44
08-18	12,7	0.50	3/4-16	M18 x 1.5	31,5	1.24	36,6	1.44
10-18	16,0	0.63	7/8-14	M18 x 1.5	36,6	1.44	39,6	1.56
10-20	16,0	0.63	7/8-14	M20 x 1.5	36,6	1.44	42,9	1.69
10-22	16,0	0.63	7/8-14	M22 x 1.5	36,6	1.44	42,9	1.69
12-22	19,0	0.75	1 ¹ / ₁₆ -12	M22 x 1.5	41,9	1.65	45,5	1.79
12-27	19,0	0.75	1 ¹ / ₁₆ -12	M27 x 2	41,9	1.65	49,0	1.93
16-33	25,4	1.00	1 ⁵ / ₁₆ -12	M33 x 2	46,0	1.81	52,0	2.05

SPECIALTY & TRUCK HOSE

LOW & MEDIUM PRESSURE HOSE

HIGH PRESSURE HOSE

HOSE FITTINGS

ADAPTERS & TUBE FITTINGS

ACCESSORIES & ASSEMBLY INSTRUCTIONS

HOSE ASSEMBLY EQUIPMENT

APPENDICIES

ORS to Metric

ORS - Special Metric Connector (Mates with DIN 3852 large spotface)

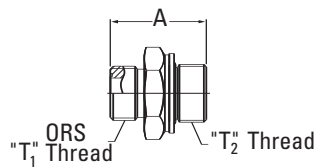

Part No. FF2485T(Size)

Dash Size	Tube O.D.		Thread T1	Thread T2	Ref A	
	mm	in			mm	in
0410S	6,4	0.25	⁹ / ₁₆ -18	M10 x 1	24,9	0.98
0614S	9,7	0.38	¹¹ / ₁₆ -16	M14 x 1.5	31,0	1.22
0818S	12,7	0.50	¹³ / ₁₆ -16	M18 x 1.5	33,6	1.32
0822S	12,7	0.50	¹³ / ₁₆ -16	M22 x 1.5	36,3	1.43
1022S	16,0	0.63	1-14	M22 x 1.5	39,1	1.54
1227S	19,0	0.75	¹³ / ₁₆ -12	M27 x 2	44,4	1.75
1633S	25,4	1.00	¹⁷ / ₁₆ -12	M33 x 2	48,0	1.89
2042S	31,8	1.25	¹¹ / ₁₆ -12	M42 x 2	51,6	2.03
2448S	38,1	1.50	2-12	M48 x 2	55,6	2.19

ORS/Male ISO 6149 Boss (S-Series)

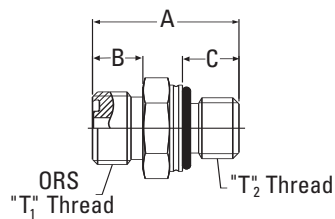

Part No. FF2742T(Size) (Ref. SAE 52M0187)

Dash Size	Tube O.D.		Thread T1	Thread T2	A		B		C	
	mm	in			mm	in	mm	in	mm	in
0410S	6,4	0.25	⁹ / ₁₆ -18	M10 x 1	27,9	1.10	9,9	0.39	9,4	0.37
0412S	6,4	0.25	⁹ / ₁₆ -18	M12 x 1.5	28,5	1.12	9,9	0.39	10,9	0.43
0612S	9,7	0.38	¹¹ / ₁₆ -16	M12 x 1.5	32,0	1.26	11,2	0.44	10,9	0.43
0614S	9,7	0.38	¹¹ / ₁₆ -16	M14 x 1.5	32,0	1.26	11,2	0.44	10,9	0.43
0616S	9,7	0.38	¹¹ / ₁₆ -16	M16 x 1.5	33,6	1.32	11,2	0.44	12,4	0.49
0818S	12,7	0.50	¹³ / ₁₆ -16	M18 x 1.5	38,1	1.50	12,7	0.50	14,0	0.55
0822S	12,7	0.50	¹³ / ₁₆ -16	M22 x 1.5	39,4	1.55	12,7	0.50	15,0	0.59
1022S	16,0	0.63	1-14	M22 x 1.5	41,9	1.65	15,5	0.61	15,0	0.59
1222S	19,0	0.75	¹³ / ₁₆ -12	M22 x 1.5	43,4	1.71	17,0	0.67	15,0	0.59
1227S	19,0	0.75	¹³ / ₁₆ -12	M27 x 2	48,5	1.91	17,0	0.67	18,5	0.73
1633S	25,4	1.00	¹⁷ / ₁₆ -12	M33 x 2	52,0	2.05	17,6	0.69	19,0	0.75
2042S	31,8	1.25	¹¹ / ₁₆ -12	M42 x 2	54,6	2.15	17,6	0.69	14,0	0.55
2448S	38,1	1.50	2-12	M48 x 2	56,9	2.24	15,0	0.59	21,6	0.85

45° ORS/ISO 6149 Boss (S-Series)

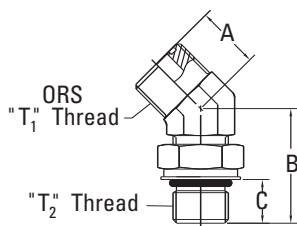

Part No. FF2743T(Size) (Ref. SAE 52M0287)

Dash Size	Tube O.D.		Thread T1	Thread T2	A		B		C	
	mm	in			mm	in	mm	in	mm	in
0818S	12,7	0.50	¹³ / ₁₆ -16	M18 x 1.5	20,3	0.80	37,1	1.46	14,2	0.56
1022S	16,0	0.63	1-14	M22 x 1.5	23,4	0.92	43,9	1.73	14,7	0.58
1227S	19,0	0.75	¹³ / ₁₆ -12	M27 x 2	25,9	1.02	50,5	1.99	18,3	0.72

90° ORS/ISO 6149 Boss (S-Series)

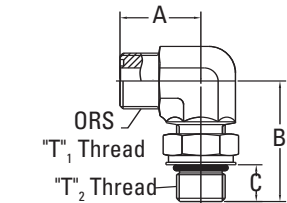

Part No. FF2744T(Size) (Ref. SAE 52M0287)

Dash Size	Tube O.D.		Thread T1	Thread T2	A		B		C	
	mm	in			mm	in	mm	in	mm	in
0818S	12,7	0.50	¹³ / ₁₆ -16	M18 x 1.5	29,7	1.17	44,2	1.74	14,2	0.56
1022S	16,0	0.63	1-14	M22 x 1.5	33,3	1.31	49,0	1.93	14,7	0.58
1227S	19,0	0.75	¹³ / ₁₆ -12	M27 x 2	37,3	1.47	55,6	2.19	18,3	0.72

ORS/ISO 6149 Boss (S-Series) Branch Tee

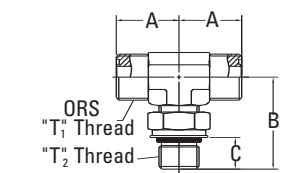

Part No. FF2745T(Size) (Ref. SAE 52M0489)

Dash Size	Tube O.D.		Thread T1	Thread T2	A		B		C	
	mm	in			mm	in	mm	in	mm	in
0818S	12,7	0.50	¹³ / ₁₆ -16	M18 x 1.5	27,9	1.10	40,9	1.61	14,2	0.56
1022S	16,0	0.63	1-14	M22 x 1.5	33,3	1.31	49,0	1.93	14,7	0.58
1227S	19,0	0.75	¹³ / ₁₆ -12	M27 x 2	37,3	1.47	55,6	2.19	18,3	0.72

SPECIALTY & TRUCK HOSE

LOW & MEDIUM PRESSURE HOSE

HIGH PRESSURE HOSE

HOSE FITTINGS

ADAPTERS & TUBE FITTINGS

ACCESSORIES & ASSEMBLY INSTRUCTIONS

HOSE ASSEMBLY EQUIPMENT

APPENDICES

ORS/ISO 6149 Boss (S-Series) Run Tee

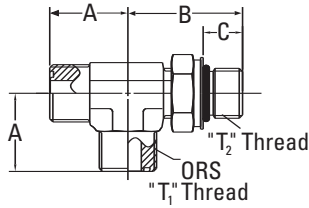

Part No. FF2746T(Size) (Ref. SAE 52M0488)

Dash Size	Tube O.D.		Thread T1	Thread T2	A		B		C	
	mm	in			mm	in	mm	in	mm	in
0818S	12,7	0.50	1 ³ / ₁₆ -16	M18 x 1.5	27,9	1.10	40,9	1.61	14,2	0.56
1022S	16,0	0.63	1-14	M22 x 1.5	33,3	1.31	49,0	1.93	14,7	0.58
1227S	19,0	0.75	1 ³ / ₁₆ -12	M27 x 2	37,3	1.47	55,6	2.19	18,3	0.72

Male ISO-6149 Boss (S-Series) Plug

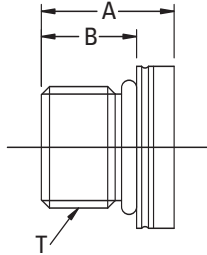

Part No. FF90396-(Dash size)

Dash Size	Thread T	A		B	
		mm	in	mm	in
14S	M14x1.5	15,0	0.59	6,1	0.24
18S	M18x1.5	18,3	0.72	8,1	0.32
22S	M22x1.5	19,3	0.76	9,9	0.39

DIN 3852 Form "A" with Dowty Seal Plug

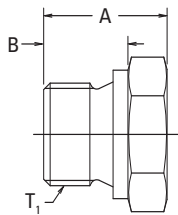

Part No. FF1939-(Dash size)

Dash Size	Tube O.D.		Thread T1	A		B	
	mm	in		mm	in	mm	in
065	9,6	0.38	G ³ / ₈	22,3	0.88	22,3	0.88
085	12,7	0.50	G ¹ / ₂	24,9	0.98	26,9	1.06

90° ORS Male/ Special BSP Parallel - Mates with DIN 3852 Large Spottface

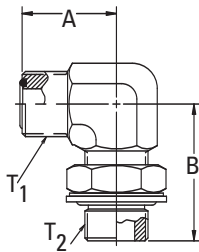

Part No. FF2484T-(Dash size)

Dash Size	Tube O.D.		Thread T1	Thread T2	A		B	
	mm	in			mm	in	mm	in
0402S	6,3	0.25	9 ¹⁶ / ₁₆ -18	G 0.13	21,6	0.85	32,5	1.28
0604S	9,6	0.38	1 ¹¹ / ₁₆ -16	G 0.25	24,9	0.98	37,1	1.46
0806S	12,7	0.50	1 ¹³ / ₁₆ -16	G 0.38	27,9	1.10	25,4	1.00
1008S	16,0	0.63	1-14	G 0.50	33,3	1.31	50,0	1.97
1212S	19,0	0.75	1 ¹³ / ₁₆ -12	G 0.75	37,3	1.47	54,9	2.16

Male Pipe NPTF/ BSP Male Parallel DIN3852 Form "B"

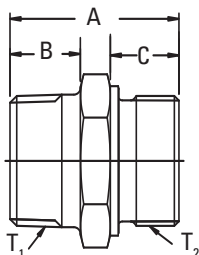

Part No. 15.000-(Dash size)*

Dash Size	Tube O.D.		Thread T1	Thread T2	A		B		C	
	mm	in			mm	in	mm	in	mm	in
4-4	6,3	0.25	1 ¹ / ₄ -18	G 1 ¹ / ₄	36,1	1.42	14,0	0.55	19,0	0.75
6-6	9,6	0.38	3 ³ / ₈ -18	G 3 ³ / ₈	38,1	1.50	14,5	0.57	22,1	0.87
8-8	12,7	0.50	1 ¹ / ₂ -14	G 1 ¹ / ₂	40,4	1.59	17,0	0.67	26,9	1.06
12-12	19,0	0.75	3 ³ / ₄ -14	G 3 ³ / ₄	44,4	1.75	19,0	0.75	32,0	1.26
16-16	25,4	1.00	1-1 ¹¹ / ₂	G 1	54,3	2.14	21,1	0.83	40,9	1.61
20-20	31,7	1.25	1 ¹ / ₄ -11	G 1 ¹ / ₄	57,1	2.25	23,1	0.91	50,0	1.97

*These adapters do not come with an O-ring on the BSP thread.

SPECIALTY & TRUCK HOSE

LOW & MEDIUM PRESSURE HOSE

HIGH PRESSURE HOSE

HOSE FITTINGS

ADAPTERS & TUBE FITTINGS

ACCESSORIES & ASSEMBLY INSTRUCTIONS

HOSE ASSEMBLY EQUIPMENT

APPENDICES

BSPP to 37° Flare

BSPP (parallel)/ 37° flare

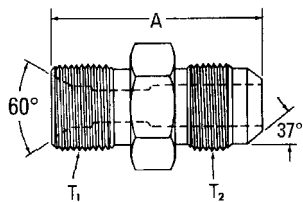

Part No. 2063-(Dash size)

Dash Size	Tube O.D.		Thread T1	Thread T2	A	
	mm	in			mm	in
2-4S	6,4	0.25	1/8-28	7/16-20	35,1	1.38
4-4S	6,4	0.25	1/4-19	7/16-20	35,1	1.38
4-5S	7,9	0.31	1/4-19	1/2-20	35,1	1.38
4-6S	9,7	0.38	1/4-19	9/16-18	35,1	1.38
6-6S	9,7	0.38	3/8-19	9/16-18	36,3	1.43
6-8S	12,7	0.50	3/8-19	3/4-16	38,9	1.53
8-8S	12,7	0.50	1/2-14	3/4-16	41,4	1.63
8-10S	16,0	0.63	1/2-14	7/8-14	43,9	1.73
10-12S	19,0	0.75	5/8-14	1 1/16-12	49,3	1.94
12-10S	16,0	0.63	3/4-14	7/8-14	47,7	1.88
12-12S	19,0	0.75	3/4-14	1 1/16-12	50,5	1.99
16-16S	25,4	1.00	1-11	1 5/16-12	53,1	2.09

Note: The BSPP male end mates with a BSPP female swivel nut.
Use GG106 conversion adapters for port connections.

SAE 37° Male/ BSPP Male

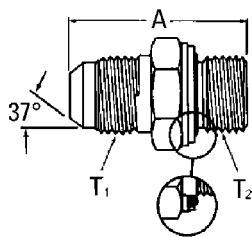

GG106-NP(Size)-(Size)

Dash Size	Tube O.D.		Thread T1	Thread T2	A	
	mm	in			mm	in
04-02	6,4	0.25	7/16-20	G 1/8-28	29,0	1.14
04-04	6,4	0.25	7/16-20	G 1/4-19	34,5	1.36
04-06	6,4	0.25	7/16-20	G 3/8-19	34,5	1.36
04-08	6,4	0.25	7/16-20	G 1/2-14	38,1	1.50
06-04	9,7	0.38	9/16-18	G 1/4-19	34,5	1.36
06-06	9,7	0.38	9/16-18	G 3/8-19	34,5	1.36
06-08	9,7	0.38	9/16-18	G 1/2-14	38,1	1.50
08-04	12,7	0.50	3/4-16	G 1/4-19	37,6	1.48
08-06	12,7	0.50	3/4-16	G 3/8-19	37,6	1.48
08-08	12,7	0.50	3/4-16	G 1/2-14	40,9	1.61
08-12	12,7	0.50	3/4-16	G 3/4-14	44,9	1.77
10-06	16,0	0.63	7/8-14	G 3/8-19	40,4	1.59
10-08	16,0	0.63	7/8-14	G 1/2-14	43,4	1.71
12-08	19,0	0.75	1 1/16-12	G 1/2-14	47,0	1.85
12-12	19,0	0.75	1 1/16-12	G 3/4-14	50,0	1.97
12-16	19,0	0.75	1 1/16-12	G 1-11	52,6	2.07
16-12	25,4	1.00	1 1/16-12	G 3/4-14	51,1	2.01
16-16	25,4	1.00	1 5/16-12	G 1-11	53,6	2.11
16-20	25,4	1.00	1 5/16-12	G 1 1/4-11	56,9	2.24
20-20	31,8	1.25	1 5/8-12	G 1 1/4-11	58,4	2.30

90° Adjustable Elbow SAE 37° Male/ BSPP Male

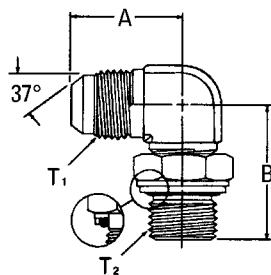

GG306-NP(Size)-(Size)

Dash Size	Tube O.D.		Thread T1	Thread T2	A		B	
	mm	in			mm	in	mm	in
04-02	6,4	0.25	7/16-20	G 1/8-28	22,6	0.89	26,4	1.04
04-04	6,4	0.25	7/16-20	G 1/4-19	26,9	1.06	31,5	1.24
05-04	7,9	0.31	1/2-20	G 1/4-19	26,9	1.06	31,5	1.24
06-04	9,7	0.38	9/16-18	G 1/4-19	26,9	1.06	31,5	1.24
06-06	9,7	0.38	9/16-18	G 3/8-19	28,5	1.12	36,6	1.44
06-08	9,7	0.38	9/16-18	G 1/2-14	31,0	1.22	42,9	1.69
08-06	12,7	0.50	3/4-16	G 3/8-19	31,5	1.24	36,6	1.44
08-08	12,7	0.50	3/4-16	G 1/2-14	34,0	1.34	42,9	1.69
10-08	16,0	0.63	7/8-14	G 1/2-14	36,6	1.44	42,9	1.69
12-12	19,0	0.75	1 1/16-12	G 3/4-14	41,9	1.65	49,0	1.93
16-16	25,4	1.00	1 5/16-12	G 1-11	46,0	1.81	52,6	2.07
20-20	31,8	1.25	1 5/8-12	G 1 1/4-11	52,0	2.05	56,9	2.24

SPECIALTY & TRUCK HOSE
 LOW & MEDIUM PRESSURE HOSE
 HIGH PRESSURE HOSE
 HOSE FITTINGS
 ADAPTERS & TUBE FITTINGS
 ACCESSORIES & ASSEMBLY INSTRUCTIONS
 HOSE ASSEMBLY EQUIPMENT
 APPENDICES

BSPT to 37° Flare

SAE 37° Male/
BSPT Male

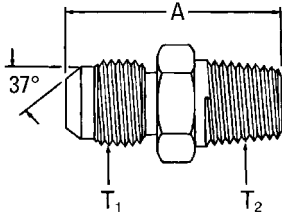

GG110-NP(Size)-(Size)

Dash Size	Tube O.D.		Thread T1	Thread T2	A	
	mm	in			mm	in
04-02	6,4	0.25	7/16-20	R1/8-28	29,0	1.14
04-04	6,4	0.25	7/16-20	R1/4-19	33,0	1.30
06-04	9,7	0.38	9/16-18	R1/4-19	33,6	1.32
06-06	9,7	0.38	9/16-18	R3/8-19	33,6	1.32
08-06	12,7	0.50	3/4-16	R3/8-19	36,6	1.44
08-08	12,7	0.50	3/4-16	R1/2-14	40,4	1.59
10-08	16,0	0.63	7/8-14	R1/2-14	42,9	1.69
12-08	19,0	0.75	1 1/16-12	R1/2-14	47,5	1.87
12-12	19,0	0.75	1 1/16-12	R3/4-14	49,5	1.95
12-16	19,0	0.75	1 1/16-12	R1-11	51,6	2.03
16-12	25,4	1.00	1 5/16-12	R3/4-14	50,5	1.99
16-16	25,4	1.00	1 5/16-12	R1-11	52,6	2.07

90° Elbow,
SAE 37° Male/
BSPT Male

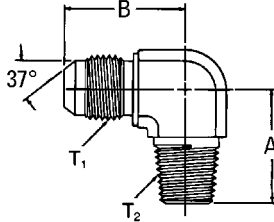

GG310-NP(Size)-(Size)

Dash Size	Tube O.D.		Thread T1	Thread T2	A		B	
	mm	in			mm	in	mm	in
04-02	6,4	0.25	7/16-20	R1/8-28	20,6	0.81	23,4	0.92
04-04	6,4	0.25	7/16-20	R1/4-19	27,4	1.08	26,9	1.06
06-04	9,7	0.38	9/16-18	R1/4-19	27,4	1.08	26,9	1.06
06-06	9,7	0.38	9/16-18	R3/8-19	31,0	1.22	28,5	1.12
06-08	9,7	0.38	9/16-18	R1/2-14	37,1	1.46	31,0	1.22
08-06	12,7	0.50	3/4-16	R3/8-19	31,0	1.22	31,5	1.24
08-08	12,7	0.50	3/4-16	R1/2-14	37,1	1.46	34,0	1.34
12-12	19,0	0.75	1 1/16-12	R3/4-14	40,4	1.59	41,9	1.65
16-16	25,4	1.00	1 5/16-12	R1-11	50,0	1.97	46,0	1.81

JIS 30° to 37° Flare

Female Cone Seat
JIS 30° Female
Cone Seat/SAE
37° Male

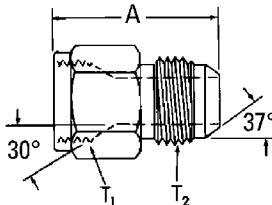

Part No. FF2593-(Size)

Dash Size	Tube O.D.		Thread T1	Thread T2	A	
	mm	in			mm	in
0404S	6,4	0.25	G1/4-19	7/16-20	30,3	1.19
0606S	9,7	0.38	G3/8-19	9/16-18	30,7	1.21
0808S	12,7	0.50	G1/2-14	3/4-16	35,8	1.41
1212S	19,0	0.75	G3/4-14	1 1/16-12	43,2	1.70

SPECIALTY &
TRUCK HOSE

LOW & MEDIUM
PRESSURE HOSE

HIGH PRESSURE HOSE

HOSE FITTINGS

ADAPTERS &
TUBE FITTINGS

ACCESSORIES &
ASSEMBLY INSTRUCTIONS

HOSE ASSEMBLY
EQUIPMENT

APPENDICES

Stainless Steel Adapters

Eaton stainless steel adapters are manufactured from 316 stainless steel for excellent corrosive resistance. All parts meet dimensional and performance requirements of SAE J514.

Additionally, all parts are passivated after machining to increase corrosive protection.

Applications:

- Marine/Military
- Chemical Processing
- Pulp and Paper Industry
- Food and Beverage Processing
- Off-Shore Drilling

Note: Stainless steel threaded products are susceptible to galling. Sealing surfaces and threads may be severely damaged due to the high pressure associated with assembly. It is recommended that a high-pressure lubricant be used to prevent galling.

Torque Requirements

SAE Degree (JIC)

Dash Size	Thread Size (Inches)	Swivel Nut Torque	
		Ft./Lbs.	Newton Meters
-04	7/16-20	11-12	15-16
-05	1/2-20	15-16	20-22
-06	9/16-18	18-20	24-28
-08	3/4-16	38-42	52-88
-10	7/8-14	57-62	77-85
-12	1 1/16-12	79-87	108-119
-16	1 5/16-12	108-113	148-154
-20	1 5/8-12	127-133	173-182
-24	1 7/8-12	158-167	216-227
-32	2 1/2-12	245-258	334-352

Straight Thread O-Ring

Low pressure with 37° (SAE J514)

Dash Size	Thread Size (Inches)	Swivel Nut Torque	
		Ft./Lbs.	Newton Meters
-03	3/8-24	8-9	12-13
-04	7/16-20	13-15	18-20
-05	1/2-20	14-15	19-21
-06	9/16-18	23-24	32-33
-08	3/4-16	40-43	55-57
-10	7/8-14	43-48	59-64
-12	1 1/16-12	68-75	93-101
-14	1 3/16-12	83-90	113-122
-16	1 5/16-12	112-123	152-166
-20	1 5/8-12	146-161	198-218
-24	1 7/8-12	154-170	209-230
-32	2 1/2-12	218-240	296-325

Pipe NPTF to NPTF Reducer Bushings

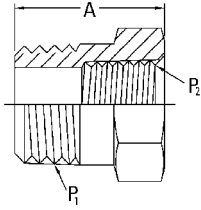

Part Number	Thread P1	Thread P2	A	
			mm	in
259-2081-4-2	1/4-18	1/8-27	21,6	0.85
259-2081-6-2	3/8-18	1/8-27	21,6	0.85
259-2081-6-4	3/8-18	1/4-18	25,4	1.00
259-2081-8-2	1/2-14	1/8-27	27,9	1.10
259-2081-8-4	1/2-14	1/4-18	27,9	1.10
259-2081-8-6	1/2-14	3/8-18	28,5	1.12
259-2081-12-4	3/4-14	1/4-18	29,7	1.17
259-2081-12-6	3/4-14	3/8-18	29,7	1.17
259-2081-12-8	3/4-14	1/2-14	34,5	1.36
259-2081-16-6	1-11 1/2	3/8-18	34,5	1.36
259-2081-16-8	1-11 1/2	1/2-14	34,5	1.36
259-2081-16-12	1-11 1/2	3/4-14	37,8	1.49
259-2081-20-12	1 1/4-11 1/2	3/4-14	37,3	1.47
259-2081-20-16	1 1/4-11 1/2	1-11 1/2	40,9	1.61
259-2081-24-12	1 1/2-11 1/2	3/4-14	39,9	1.57
259-2081-24-16	1 1/2-11 1/2	1-11 1/2	39,9	1.57
259-2081-32-16	2-11 1/2	1-11 1/2	44,4	1.75
259-2081-32-20	2-11 1/2	1 1/4-11 1/2	44,4	1.75
259-2081-32-24	2-11 1/2	1 1/2-11 1/2	44,4	1.75

Plugs

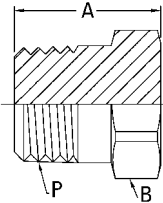

Part Number	Thread P1	A		B	
		mm	in	mm	in
259-2082-2	1/8-27	14,7	0.58	11,2	0.44
259-2082-4	1/4-18	19,3	0.76	14,2	0.56
259-2082-6	3/8-18	20,1	0.79	17,6	0.69
259-2082-8	1/2-14	24,9	0.98	22,4	0.88
259-2082-12	3/4-14	27,4	1.08	26,9	1.06
259-2082-16	1-11 1/2	32,3	1.27	33,3	1.31
259-2082-20	1 1/4-11 1/2	33,0	1.30	44,4	1.75
259-2082-24	1 1/2-11 1/2	33,8	1.33	50,8	2.00
259-2082-32	2-11 1/2	35,3	1.39	63,5	2.50

Hexagon Pipe Nipples

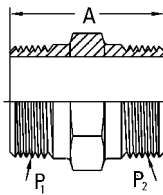

Part Number	Thread P1	Thread P2	A	
			mm	in
259-2083-4-4	1/4-18	1/4-18	36,8	1.45
259-2083-6-4	3/8-18	1/4-18	36,8	1.45
259-2083-6-6	3/8-18	3/8-18	36,8	1.45
259-2083-8-6	1/2-14	3/8-18	43,2	1.70
259-2083-8-8	1/2-14	1/2-14	48,0	1.89
259-2083-12-8	3/4-14	1/2-14	49,8	1.96
259-2083-12-12	3/4-14	3/4-14	49,8	1.96
259-2083-16-12	1-11 1/2	3/4-14	54,6	2.15
259-2083-16-16	1-11 1/2	1-11 1/2	59,4	2.34
259-2083-20-16	1 1/4-11 1/2	1-11 1/2	62,2	2.45
259-2083-20-20	1 1/4-11 1/2	1 1/4-11 1/2	63,0	2.48
259-2083-24-24	1 1/2-11 1/2	1 1/2-11 1/2	66,3	2.61

90° Male Pipe Elbows

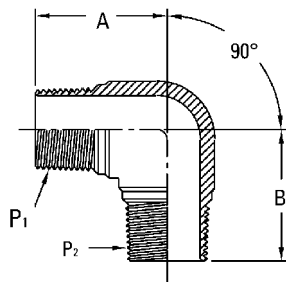

Part Number	Thread P1	Thread P2	A		B	
			mm	in	mm	in
259-2085-4-4	1/4-18	1/4-18	27,7	1.09	27,7	1.09
259-2085-6-4	3/8-18	1/4-18	31,0	1.22	31,0	1.22
259-2085-6-6	3/8-18	3/8-18	31,0	1.22	31,0	1.22
259-2085-8-6	1/2-14	3/8-18	37,3	1.47	32,5	1.28
259-2085-8-8	1/2-14	1 1/2-14	37,3	1.47	37,3	1.47
259-2085-12-12	3/4-14	3/4-14	40,4	1.59	40,4	1.59
259-2085-16-16	1-11 1/2	1-11 1/2	50,0	1.97	50,0	1.97

90° Female Pipe Elbows

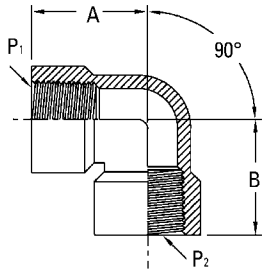

Part Number	Thread P1	Thread P2	A		B	
			mm	in	mm	in
259-2087-4-4	1/4-18	1/4-18	22,4	0.88	22,4	0.88
259-2087-6-6	3/8-18	3/8-18	25,9	1.02	25,9	1.02
259-2087-8-6	1/2-14	3/8-18	31,2	1.23	25,7	1.01
259-2087-8-8	1/2-14	1/2-14	31,2	1.23	31,2	1.23
259-2087-12-12	3/4-14	3/4-14	34,5	1.36	34,5	1.36
259-2087-16-16	1-11 1/2	1-11 1/2	41,1	1.62	41,1	1.62
259-2087-20-20	1 1/4-11 1/2	1 1/4-11 1/2	43,2	1.70	43,2	1.70

45° Pipe Street Elbows

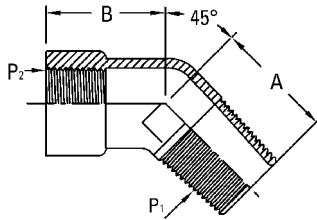

Part Number	Thread P1	Thread P2	A		B	
			mm	in	mm	in
259-2088-4-4	1/4-18	1/4-18	26,7	1.05	15,7	0.62
259-2088-6-6	3/8-18	3/8-18	26,9	1.06	18,3	0.72
259-2088-8-8	1/2-14	1/2-14	34,0	1.34	23,1	0.91
259-2088-12-12	3/4-14	3/4-14	35,1	1.38	24,6	0.97
259-2088-16-16	1-11 1/2	1-11 1/2	43,7	1.72	28,5	1.12

90° Pipe Street Elbows

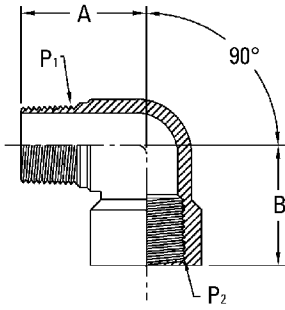

Part Number	Thread P1	Thread P2	A		B	
			mm	in	mm	in
259-2089-4-4	1/4-18	1/4-18	27,7	1.09	22,4	0.88
259-2089-4-6	1/4-18	3/8-18	31,0	1.22	25,9	1.02
259-2089-6-4	3/8-18	1/4-18	31,0	1.22	24,1	0.95
259-2089-6-6	3/8-18	3/8-18	31,0	1.22	25,9	1.02
259-2089-6-8	3/8-18	1 1/2-14	32,5	1.28	31,2	1.23
259-2089-8-6	1/2-14	3/8-18	37,3	1.47	28,5	1.12
259-2089-8-8	1/2-14	1/2-14	37,3	1.47	31,2	1.23
259-2089-12-8	3/4-14	1/2-14	40,4	1.59	34,3	1.35
259-2089-12-12	3/4-14	3/4-14	40,4	1.59	34,5	1.36
259-2089-16-16	1-11 1/2	1-11 1/2	50,0	1.97	41,1	1.62
259-2089-20-20	1 1/4-11 1/2	1 1/4-11 1/2	60,4	2.38	43,2	1.70
259-2089-24-24	1 1/2-11 1/2	1 1/2-11 1/2	67,0	2.64	52,8	2.08

Female Pipe Tee

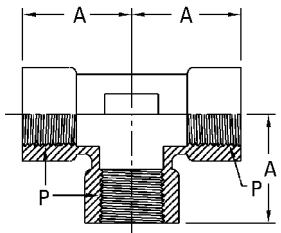

Part Number	Thread P	A	
		mm	in
259-2090-4-4	1/4-18	22,4	0.88
259-2090-6-6	3/8-18	25,9	1.02
259-2090-8-8	1/2-14	31,2	1.23
259-2090-12-12	3/4-14	34,5	1.36
259-2090-16-16	1-11 1/2	41,1	1.62
259-2090-20-20	1 1/4-11 1/2	43,2	1.70
259-2090-24-24	1 1/2-11 1/2	52,8	2.08

Male Branch Tee

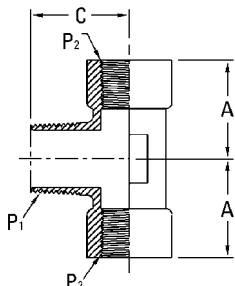

Part Number	Thread P1	Thread P2	A		C	
			mm	in	mm	in
259-2091-4-4	1/4-18	1/4-18	22,4	0.88	27,7	1.09
259-2091-6-6	3/8-18	3/8-18	25,9	1.02	31,0	1.22
259-2091-8-8	1/2-14	1/2-14	31,2	1.23	37,3	1.47
259-2091-12-12	3/4-14	3/4-14	34,5	1.36	40,4	1.59
259-2091-16-16	1-11 1/2	1-11 1/2	41,1	1.62	50,0	1.97

Street Tee

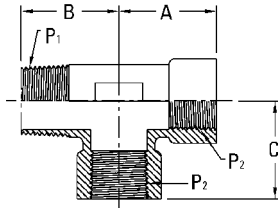

Part Number	Thread P1	Thread P2	A		B		C	
			mm	in	mm	in	mm	in
259-2092-4-4	1/4-18	1/4-18	22,4	0.88	27,7	1.09	22,4	0.88
259-2092-6-6	3/8-18	3/8-18	25,9	1.02	31,0	1.22	25,9	1.02
259-2092-8-8	1/2-14	1/2-14	31,2	1.23	37,3	1.47	31,2	1.23
259-2092-12-12	3/4-14	3/4-14	34,5	1.36	40,4	1.59	34,5	1.36
259-2092-16-16	1-11 1/2	1-11 1/2	41,1	1.62	50,0	1.97	41,1	1.62
259-2092-20-20	1 1/4-11 1/2	1 1/4-11 1/2	43,2	1.70	60,4	2.38	43,2	1.70

Hexagon Pipe Coupling

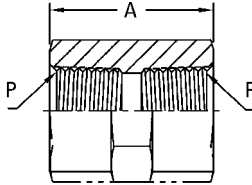

Part Number	Thread P	A	
		mm	in
259-2096-4	1/4-18	28,7	1.13
259-2096-6	3/8-18	28,7	1.13
259-2096-8	1/2-14	38,1	1.50
259-2096-12	3/4-14	38,9	1.53
259-2096-16	1-11 1/2	48,0	1.89
259-2096-20	1 1/4-11 1/2	49,0	1.93
259-2096-24	1 1/2-11 1/2	49,0	1.93

Pipe NPT to SAE 37° Flare

Male Connector

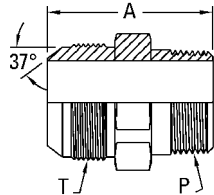

Part Number	Tube O.D.		Thread P	Thread T	A	
	mm	in			mm	in
259-2021-4-4	6,3	0.25	1/4-18	7/16-20	36,1	1.42
259-2021-4-6	9,6	0.38	1/4-18	9/16-18	36,3	1.43
259-2021-6-6	9,6	0.38	3/8-18	9/16-18	36,3	1.43
259-2021-6-8	12,7	0.50	3/8-18	3/4-16	38,9	1.53
259-2021-8-8	12,7	0.50	1/2-14	3/4-16	45,5	1.79
259-2021-12-12	19,0	0.75	3/4-14	1 1/16-12	52,3	2.06
259-2021-16-16	25,4	1.00	1-11 1/2	1 5/16-12	58,4	2.30
259-2021-16-20	31,7	1.25	1-11 1/2	1 5/8-12	61,5	2.42
259-2021-20-16	25,4	1.00	1 1/4-11 1/2	1 5/16-12	61,0	2.40
259-2021-20-20	31,7	1.25	1 1/4-11 1/2	1 5/8-12	62,2	2.45

45° Male Elbow

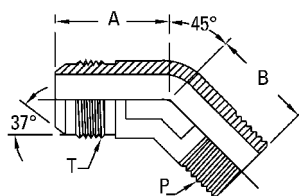

Part Number	Tube O.D.		Thread P	Thread T	A		B	
	mm	in			mm	in	mm	in
259-2023-4-4	6,3	0.25	1/4-18	7/16-20	20,8	0.82	21,8	0.86
259-2023-6-6	9,6	0.38	3/8-18	9/16-18	22,4	0.88	24,1	0.95
259-2023-6-8	12,7	0.50	3/8-18	3/4-16	24,9	0.98	24,1	0.95
259-2023-8-6	9,6	0.38	1/2-14	9/16-18	23,1	0.91	29,7	1.17
259-2023-8-8	12,7	0.50	1/2-14	3/4-16	25,4	1.00	29,7	1.17
259-2023-12-12	19,0	0.75	3/4-14	1 1/16-12	32,5	1.28	30,5	1.20
259-2023-16-16	25,4	1.00	1-11 1/2	1 5/16-12	37,3	1.47	37,6	1.48
259-2023-20-20	31,7	1.25	1 1/4-11 1/2	1 5/8-12	40,4	1.59	42,4	1.67
259-2023-24-24	38,1	1.50	1 1/2-11 1/2	1 7/8-12	45,2	1.78	44,9	1.77

Bulkhead w/Jam Nut

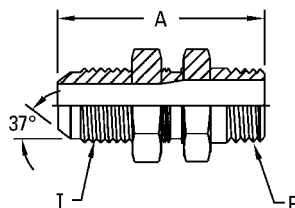

Part Number	Tube O.D.		Thread P	Thread T	A	
	mm	in			mm	in
259-2240-4-4	6,3	0.25	7/16-20	1/4-18	51,6	2.03
259-2240-4-6	9,6	0.38	9/16-18	1/4-18	53,9	2.12
259-2240-6-8	12,7	0.50	3/4-16	3/8-18	59,9	2.36
259-2240-12-12	19,0	0.75	1 1/16-12	3/4-14	74,2	2.92
259-2240-16-16	25,4	1.00	1 5/16-12	1-11 1/2	79,0	3.11

SPECIALTY & TRUCK HOSE

LOW & MEDIUM PRESSURE HOSE

HIGH PRESSURE HOSE

HOSE FITTINGS

ADAPTERS & TUBE FITTINGS

ACCESSORIES & ASSEMBLY INSTRUCTIONS

HOSE ASSEMBLY EQUIPMENT

APPENDICES

Female Connector

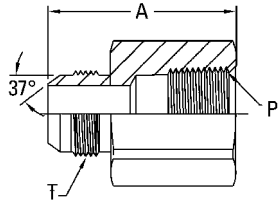

Part Number	Tube O.D.		Thread P	Thread T	A	
	mm	in			mm	in
259-2022-4-4	6,3	0.25	1/4-18	7/16-20	35,3	1.39
259-2022-6-6	9,6	0.38	3/8-18	9/16-18	37,1	1.46
259-2022-6-8	12,7	0.50	3/8-18	3/4-16	39,6	1.56
259-2022-8-8	12,7	0.50	1/2-14	3/4-16	45,5	1.79
259-2022-12-12	19,0	0.75	3/4-14	1 1/16-12	52,3	2.06
259-2022-16-16	25,4	1.00	1-1 1/2	1 5/16-12	59,7	2.35
259-2022-20-20	31,7	1.25	1 1/4-1 1/2	1 5/8-12	63,2	2.49
259-2022-24-24	38,1	1.50	1 1/2-1 1/2	1 7/8-12	66,5	2.62

90° Male Elbow

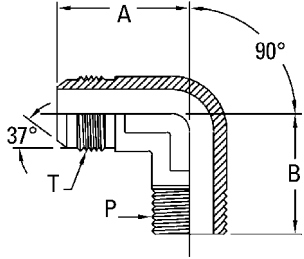

Part Number	Tube O.D.		Thread P	Thread T	A		B	
	mm	in			mm	in	mm	in
259-2024-4-4	6,3	0.25	1/4-18	7/16-20	26,7	1.05	27,7	1.09
259-2024-4-6	9,6	0.38	1/4-18	9/16-18	26,9	1.06	27,7	1.09
259-2024-6-6	9,6	0.38	3/8-18	9/16-18	29,0	1.14	31,0	1.22
259-2024-6-8	12,7	0.50	3/8-18	3/4-16	31,8	1.25	31,0	1.22
259-2024-8-8	12,7	0.50	1/2-14	3/4-16	33,8	1.33	37,3	1.47
259-2024-12-12	19,0	0.75	3/4-14	1 1/16-12	42,2	1.66	40,4	1.59
259-2024-16-16	25,4	1.00	1-1 1/2	1 5/16-12	46,0	1.81	50,0	1.97
259-2024-16-20	31,7	1.25	1-1 1/2	1 5/8-12	52,3	2.06	59,7	2.35
259-2024-20-20	31,7	1.25	1 1/4-1 1/2	1 5/8-12	52,3	2.06	60,4	2.38
259-2024-24-24	38,1	1.50	1 1/2-1 1/2	1 7/8-12	59,2	2.33	67,0	2.64

SAE 37° Flare Union

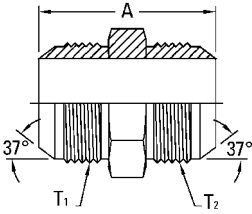

Part Number	Tube O.D.		Thread T1	Thread T2	A	
	mm	in			mm	in
259-2027-4-4	6,3	0.25	7/16-20	7/16-20	34,8	1.37
259-2027-6-4	6,3	0.25	9/16-18	7/16-20	35,6	1.40
259-2027-6-6	9,6	0.38	9/16-18	9/16-18	35,8	1.41
259-2027-8-6	9,6	0.38	3/4-16	9/16-18	38,6	1.52
259-2027-8-8	12,7	0.50	3/4-16	3/4-16	41,1	1.62
259-2027-12-12	19,0	0.75	1 1/16-12	1 1/16-12	54,9	2.16
259-2027-16-16	25,4	1.00	1 5/16-12	1 5/16-12	57,2	2.25
259-2027-20-20	31,7	1.25	1 5/8-12	1 5/8-12	61,7	2.43
259-2027-24-24	38,1	1.50	1 7/8-12	1 7/8-12	69,8	2.75

90° Union Elbow

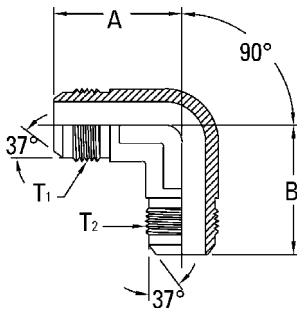

Part Number	Tube O.D.		Thread T1	Thread T2	A		B	
	mm	in			mm	in	mm	in
259-2039-4-4	6,3	0.25	7/16-20	7/16-20	22,6	0.89	22,6	0.89
259-2039-6-6	9,6	0.38	9/16-18	9/16-18	26,9	1.06	26,9	1.06
259-2039-8-8	12,7	0.50	3/4-16	3/4-16	31,8	1.25	31,8	1.25
259-2039-12-12	19,0	0.75	1 1/16-12	1 1/16-12	42,2	1.66	42,2	1.66
259-2039-16-16	25,4	1.00	1 5/16-12	1 5/16-12	46,0	1.81	46,0	1.81
259-2039-20-20	31,7	1.25	1 5/8-12	1 5/8-12	52,3	2.06	52,3	2.06
259-2039-24-24	38,1	1.50	1 7/8-12	1 7/8-12	59,2	2.33	59,2	2.33

90° Swivel Elbow

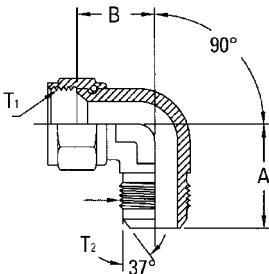

Part Number	Tube O.D.		Thread T1	Thread T2	A		B	
	mm	in			mm	in	mm	in
259-2071-4-4	6,3	0.25	7/16-20	7/16-20	22,6	0.89	16,8	0.66
259-2071-6-6	9,6	0.38	9/16-18	9/16-18	26,9	1.06	22,4	0.88
259-2071-8-8	12,7	0.50	3/4-16	3/4-16	31,8	1.25	24,4	0.96
259-2071-10-10	16,0	0.63	7/8-14	7/8-14	36,8	1.45	28,5	1.12
259-2071-12-12	19,0	0.75	1 1/16-12	1 1/16-12	42,2	1.66	30,3	1.19
259-2071-16-16	25,4	1.00	1 5/16-12	1 5/16-12	46,0	1.81	35,8	1.41
259-2071-20-20	31,7	1.25	1 5/8-12	1 5/8-12	52,3	2.06	42,7	1.68
259-2071-24-24	38,1	1.50	1 7/8-12	1 7/8-12	59,2	2.33	47,2	1.86

SPECIALTY & TRUCK HOSE
 LOW & MEDIUM PRESSURE HOSE
 HIGH PRESSURE HOSE
 HOSE FITTINGS
 ADAPTERS & TUBE FITTINGS
 ACCESSORIES & ASSEMBLY INSTRUCTIONS
 HOSE ASSEMBLY EQUIPMENT
 APPENDICES

O-Ring Boss to SAE 37° Flare

90° Straight Thread Elbow

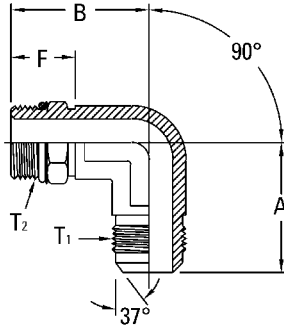

Part Number	Tube O.D.		Thread P	Thread T	A		B	
	mm	in			mm	in	mm	in
259-2062-4-4	6,3	0.25	7/16-20	7/16-20	22,6	0.89	26,2	1.03
259-2062-4-6	9,6	0.38	9/16-18	7/16-20	26,9	1.06	30,3	1.19
259-2062-6-4	6,3	0.25	7/16-20	9/16-18	26,7	1.05	31,8	1.25
259-2062-6-6	9,6	0.38	9/16-18	9/16-18	26,9	1.06	31,8	1.25
259-2062-6-8	12,7	0.50	3/4-16	9/16-18	31,8	1.25	33,6	1.32
259-2062-8-6	9,6	0.38	9/16-18	3/4-16	29,0	1.14	36,8	1.45
259-2062-8-8	12,7	0.50	3/4-16	3/4-16	31,8	1.25	36,8	1.45
259-2062-12-12	19,0	0.75	1 1/16-12	1 1/16-12	42,2	1.66	49,3	1.94
259-2062-12-16	25,4	1.00	1 5/16-12	1 1/16-12	44,7	1.76	52,0	2.05
259-2062-16-12	19,0	0.75	1 1/16-12	1 5/16-12	46,0	1.81	52,0	2.05
259-2062-16-16	25,4	1.00	1 5/16-12	1 5/16-12	46,0	1.81	52,0	2.05
259-2062-16-20	31,7	1.25	1 5/8-12	1 5/16-12	51,1	2.01	57,2	2.25
259-2062-20-16	25,4	1.00	1 5/16-12	1 5/8-12	52,3	2.06	56,6	2.23
259-2062-20-20	31,7	1.25	1 5/8-12	1 5/8-12	52,3	2.06	57,2	2.25
259-2062-20-24	38,1	1.50	1 7/8-12	1 5/8-12	55,9	2.20	60,7	2.39
259-2062-24-24	38,1	1.50	1 7/8-12	1 7/8-12	59,2	2.33	60,7	2.39

Straight Thread Short Connector

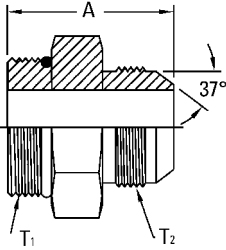

Part Number	Tube O.D.		Thread P	Thread T	A	
	mm	in			mm	in
259-202702-4-4	6,3	0.25	7/16-20	7/16-20	31,2	1.23
259-202702-4-6	9,6	0.38	7/16-20	9/16-18	32,3	1.27
259-202702-6-4	6,3	0.25	9/16-18	7/16-20	32,8	1.29
259-202702-6-6	9,6	0.38	9/16-18	9/16-18	33,0	1.30
259-202702-6-8	12,7	0.50	9/16-18	3/4-16	36,6	1.44
259-202702-8-6	9,6	0.38	3/4-16	9/16-18	35,1	1.38
259-202702-8-8	12,7	0.50	3/4-16	3/4-16	37,6	1.48
259-202702-12-8	12,7	0.50	1 1/16-12	3/4-16	44,7	1.76
259-202702-12-12	19,0	0.75	1 1/16-12	1 1/16-12	50,0	1.97
259-202702-12-16	25,4	1.00	1 1/16-12	1 5/16-12	51,8	2.04
259-202702-16-12	19,0	0.75	1 5/16-12	1 1/16-12	50,5	1.99
259-202702-16-16	25,4	1.00	1 5/16-12	1 5/16-12	51,8	2.04
259-202702-16-20	31,7	1.25	1 5/16-12	1 5/8-12	59,2	2.33
259-202702-20-16	25,4	1.00	1 5/8-12	1 5/16-12	53,9	2.12
259-202702-20-20	31,7	1.25	1 5/8-12	1 5/8-12	55,2	2.17
259-202702-20-24	38,1	1.50	1 5/8-12	1 7/8-12	64,3	2.53
259-202702-24-20	31,7	1.25	1 7/8-12	1 5/8-12	56,9	2.24
259-202702-24-24	38,1	1.50	1 7/8-12	1 7/8-12	60,2	2.37

SAE 37° Flare Nuts and Sleeves

Nuts

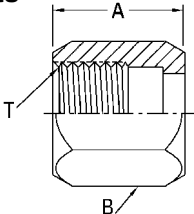

Part Number	Tube O.D.		Thread P	Thread T	A	
	mm	in			mm	in
259-1290-4	6,3	0.25	7/16-20	.62	14,2	0.56
259-1290-6	9,6	0.38	9/16-18	.72	17,6	0.69
259-1290-8	12,7	0.50	3/4-16	.84	22,4	0.88
259-1290-10	16,0	0.63	7/8-14	.97	25,4	1.00
259-1290-12	19,0	0.75	1 1/16-12	1.02	31,8	1.25
259-1290-16	25,4	1.00	1 5/16-12	1.12	38,1	1.50
259-1290-20	31,7	1.25	1 5/8-12	1.22	50,8	2.00
259-1290-24	38,1	1.50	1 7/8-12	1.41	57,2	2.25

Sleeves

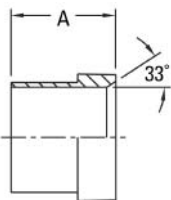

Part Number	Tube O.D.		A	
	mm	in	mm	in
259-900605-4	6,3	0.25	10,4	0.41
259-900605-6	9,6	0.38	12,7	0.50
259-900605-8	12,7	0.50	14,2	0.56
259-900605-10	16,0	0.63	16,8	0.66
259-900605-12	19,0	0.75	17,6	0.69
259-900605-16	25,4	1.00	19,8	0.78
259-900605-20	31,7	1.25	23,1	0.91
259-900605-24	38,1	1.50	28,5	1.12

SPECIALTY & TRUCK HOSE

LOW & MEDIUM PRESSURE HOSE

HIGH PRESSURE HOSE

HOSE FITTINGS

ADAPTERS & TUBE FITTINGS

ACCESSORIES & ASSEMBLY INSTRUCTIONS

HOSE ASSEMBLY EQUIPMENT

APPENDICES

7000 Series Ermeto

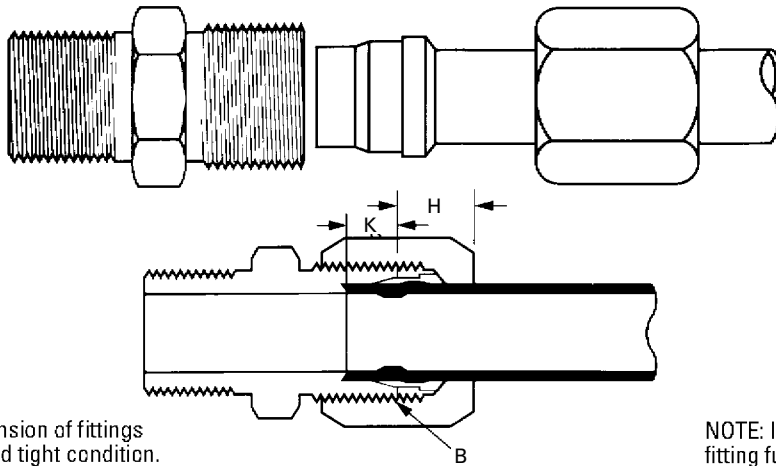

NOTE: "H" is dimension of fittings assembled to hand tight condition.

NOTE: Illustration shows fitting fully assembled.

Tube O.D.	1/8	3/16	1/4	5/16	3/8	1/2	5/8	3/4	7/8	1	1 1/4	1 1/2	2
Thread Size-B	5/16-24	3/8-24	7/16-20	1/2-20	9/16-18	3/4-16	7/8-14	1 1/16-12	1 3/16-12	1 5/16-12	1 7/8-12	1 7/8-12	2 1/2-12
Seat Depth-K	.19	.24	.24	.26	.26	.31	.36	.36	.36	.42	.42	.49	.49
H (Ref.)	.31	.30	.39	.41	.47	.48	.53	.55	.53	.63	.56	.61	.64

• Typical Application

Hydraulic, instrumentation and chemical processing systems. Highly recommended for high pressure applications.

• Pressure

Operating pressure up to 10,000 psi depending on tube and fitting size. See steel fittings recommendations, pages 285.

• Vibration

Excellent resistance.

• Temperature Range

-65°F to +400°F (-53°C to +204°C) at maximum operating pressures. Has been used at 800°F and 1000 psi to 4000 psi depending on tube size. Stainless steel has been used at +1000°F and 2000 psi.

• Material

Carbon Steel - AISI/SAE 12L14

Plating - Black Zinc Phosphate

Stainless Steel - Bodies and nuts: type 316. Sleeves: 17-4PH.

• Used With

Aluminum, hard or half copper, steel, stainless steel, monel, titanium and extra heavy wall tubing that cannot be flared.

• Advantages

An excellent high pressure fitting - NO TUBE FLARING. Used with extra heavy wall tubing. Broad selection of sizes and styles.

• Conformance

Meets specifications and standards of ASA, ASME and SAE.

• How to Order

For complete assembly (body, nut sleeve) order individually by part number. Example: 7205x4. To order body only (less nut and sleeve), prefix the part number with the letter B. Example: B7205x4. Nuts and sleeves can be ordered separately by part number.

• NOTE

Refer to current price list for availability of cataloged items. Quotations and delivery of non-stock items supplied on request. Configurations and dimensions subject to change without notice. Additional information can be found in SAE J514.

• Assembly Instructions

See page 284.

Ermeto Fittings (7000 Series) are especially designed for making leak-proof tube connections. This fitting will effectively withstand high pressure, severe vibration and extreme temperature. No special tools are needed for assembly. Simply cut tube square, preset sleeve on tubing and assemble.

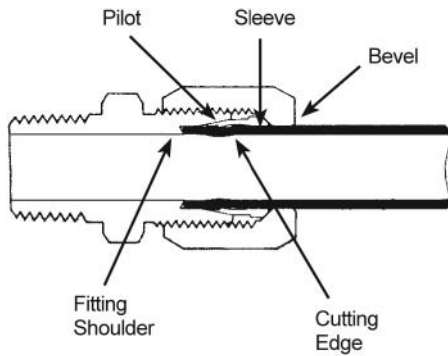

ERMETO Design Principle Provides Positive Seal

1. In presetting, as the nut is tightened it forces the sleeve forward into the body taper. See page 283 for preset instructions.
2. Pilot of sleeve contracts, forcing the cutting edge of sleeve to shear a groove into outer surface of the tube, making a tight joint between fitting and tube.
3. In assembling the preset sleeve and tube into the fitting body, the nut presses on the bevel at rear of sleeve causing it to clamp tightly to the tube. Resistance to vibration is concentrated at this point rather than at the sleeve cut.
4. When fully tightened, the case hardened sleeve is bowed slightly at the midsection and acts as a spring. This spring action of the sleeve maintains a constant tension between the body and the nut, and thus prevents the nut from loosening.
5. After the first assembly, the sleeve is permanently attached to the tube. Disassembly and reassembly of the fitting can be made without loss of strength or sealing qualities.

"7000" Series Fittings

Specifically designed to meet all SAE approved standards for hydraulic flareless tube fittings. Available in a complete range of standard body styles. In addition, the "7000" Series includes all body styles for SAE straight thread o-ring boss mounting. Complete size range to 2".

Carbon Steel "7000" Series

Eaton Ermeto Fittings have a black zinc phosphate finish, which fully resists the effects of nonflammable hydraulic fluids.

Stainless Steel "7000" Series

Fittings are also available in a complete range of body styles and sizes.

Standard stainless steel assemblies may be ordered by quoting the stainless steel part numbers appearing in this catalog. Standard stainless steel assemblies are composed of the following types of material:

Body - Type 316 Stainless Steel

Nut - Type 316 Stainless Steel

Sleeve - Type 17-4PH Stainless Steel

Any deviation from the standard assembly must be ordered as component parts. Example: If Type 316 bodies and 17-4PH sleeves are to be used, they can be ordered as follows:

B7217x8 Body only (Type 316 Stainless Steel)

7176x8 Sleeves (Type 17-4PH Stainless Steel)

7105x8 Nuts (Standard Carbon Steel)

In general, the "bite-action" of the sleeves in any given material varies as shown in the following table:

Stainless Steel Sleeves

Part No. 7176 sleeves are made from Armco 17-4PH precipitation hardened stainless steel. When used on "fully annealed" to 1/8 hard tubing in the 303 to 316 stainless range, they provide the typical seal.

"7000" SERIES SLEEVE	SLEEVE MATERIAL	TUBING USED 303 TO 316 STAINLESS AND CUPRO-NICKEL	"BITE-ACTION"
7165	Heat Treated Carbon Steel (Standard Carbon)	Fully annealed to 1/8 hard	Excellent
7176	17-4PH Stainless (Standard Stainless)	Fully annealed	Excellent

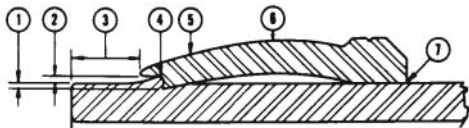
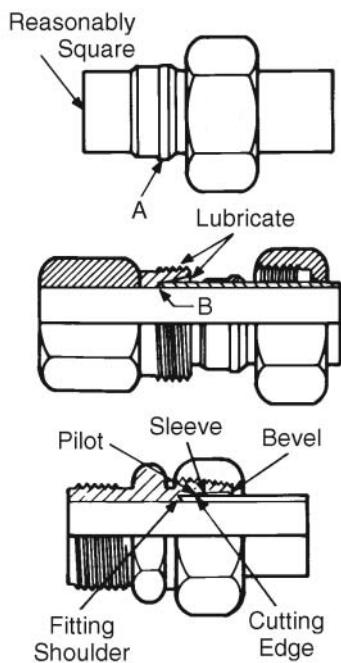

Presetting Operation

Preset with Preset Tool:

1. CAUTION: All stainless steel sleeves should be preset in tool prior to installation.
2. Slide nut and then sleeve on tube. Shoulder of sleeve "A" must be toward nut.
3. Insert tube into presetting tool. Be sure that tube is bottomed on fitting tube stop at point "B". Lubricate threads, seat of fitting and shoulder of sleeve with good grade of lubricant.
4. Turn nut slowly with wrench while turning tube with other hand. When the sleeve grips the tube, that is, when the tube can no longer be turned by hand - STOP - and note the position of the wrench. This is the "Ring Grip" point.
5. Tighten nut an additional number of turns past the ring grip point per tube size and wall thickness as shown in Table 1, page 283.
6. Disassemble from preset tool.

Preset in Fitting Body:

1. Follow same procedure as when presetting with preset tool. Once the fitting nut has been turned the proper number of turns past ring grip, the fitting assembly is complete and ready for use.

NOTE: Only Carbon Steel Sleeves can be preset directly into the fitting body. Due to possible thread galling, the use of presetting tools is required when stainless steel fittings are to be assembled.

Fitting Installation

1. After sleeve and nut have been preset on the tubing and checked as described, the assembly is ready for installation into the Ermeto fitting seat.
2. Lubricate threads, seat of fitting and shoulder of sleeve with a good grade of lubricant compatible with system fluid.
3. Insert tube assembly into fitting and tighten nut until sharp rise in torque is felt.
4. Starting at the position of sharp torque rise, tighten nut $\frac{1}{4}$ turn to complete assembly.

When the assembly procedure for Ermeto fittings is followed correctly, these points will be evident:

1. Cutting edge of sleeve will be imbedded in tubing to its full depth.
2. Pilot edge of sleeve should be close to or touching O.D. of tubing.
3. Distance between end of tube and leading or pilot edge of sleeve will be at least $\frac{1}{8}$ ".
4. Metal will be piled ahead of cutting edge of sleeve under pilot.
5. Contact area of sleeve will show evidence of being in perfect contact with tapered seat of fitting.
6. Sleeve will show evidence of being bowed within its elastic limits.
7. Back of sleeve will be in contact with tube.

NOTE: Performance of fitting will not be affected if sleeve rotates on tube after disassembly.

For Re-Installation of Fitting After Disassembly

1. Insert tube assembly into fitting, tighten nut until a sharp rise in torque is felt.
2. Starting at the position of sharp torque rise, tighten nut $\frac{1}{4}$ turn to complete the reinstallation.

**TABLE 1: Number of Additional Turns from “Ring Grip”
for Hand Presetting Operation-Ermeto Sleeve**

Tube Size	Tube Material **	TUBE WALL THICKNESS									
		.018	.022	.028	.035	.049	.065	.083	.095	.109	.120
2	C 1010 MIL T 8504	1-1/6 1-1/6	1-1/6 1-1/6	1-1/6 1-1/6	1-1/6 1-1/6						
3	C 1010 MIL T 8504	1-1/6 1-1/6	1-1/6 1-1/6	1-1/6 1-1/6	1 1						
4	C 1010 MIL T 8504			1-1/6 1-1/6	1-1/6 1	1-1/6 1	1 5/6				
5	C 1010 MIL T 8504			1-1/6 1-1/6	1-1/6 1-1/6	1-1/6 1	1 1				
6	C 1010 MIL T 8504				1-1/6 1-1/6	1-1/6 5/6	1 5/6	1 1			
8	C 1010 MIL T 8504				1-1/6 1-1/6	1-1/6 1	1 5/6	1 5/6	1 5/6		
10	C 1010 MIL T 8504					1-1/6 1-1/6	1 1	5/6 5/6	5/6 5/6	5/6	5/6
12	C 1010 MIL T 8504					1 1-1/6	1 1	5/6 5/6	5/6 5/6	5/6 5/6	
16	C 1010 MIL T 8504					1-1/6	1-1/6 1-1/6	5/6 1-1/6	5/6 5/6	5/6 5/6	5/6
20	C 1010 MIL T 8504					1-1/6 1	1 1	1 1	1 1	5/6 5/6	5/6 5/6
24	C 1010 MIL T 8504								1	1	1
32	C 1010 MIL T 8504								1	1	1

** C 1010 - Carbon Steel Tubing

** MIL T 8504 - Annealed Stainless Steel

SPECIALTY &
TRUCK HOSE

LOW & MEDIUM
PRESSURE HOSE

HIGH PRESSURE HOSE

HOSE FITTINGS

ADAPTERS &
TUBE FITTINGS

ACCESSORIES &
ASSEMBLY INSTRUCTIONS

HOSE ASSEMBLY
EQUIPMENT

APPENDICES

Hydraulic Pressure Data - ERMETO Flareless Fittings

Ermeto® fittings have been used with success on many and varied applications far exceeding the conservative conditions presented below. Specifically:

- Temperatures up to 800°F, in carbon steel and 1000°F, in stainless steel have been handled without failure.*
- Burst pressures up to 32,000 psi with 1/4" tubing.
- Vibration conditions of 1/8" off-center amplitude with 12" overhang in 1/4" tubing have been withstood at rated operating pressure with 4-to-1 safety factors for over ten million cycles.

Obviously under extreme conditions of pressure, temperature and/or vibration, the safety factor is proportionately reduced.

The Ermeto flareless fitting is the ultimate hydraulic fitting available today. Special performance conditions as outlined can be accommodated; however, it is recommended that your local Eaton representative be consulted for engineering assistance prior to finalizing design.

The values shown in the following table are pressure ratings of Ermeto flareless fittings under various surge conditions. They apply and are recommended for conservative operating conditions.

Size No.	Size in Inches	Maximum Pressure† No Surges PSI	Maximum Pressure† With Surges to 50%	Maximum Pressure† With Surges of 50% to 100%	Maximum Pressure† With Surges up to 150%
2	1/8	10,000	6,500	5,000	4,000
3	3/16	9,000	6,000	4,500	3,600
4	1/4	8,000	5,250	4,000	3,200
5	5/16	8,000	5,250	4,000	3,200
6	3/8	7,500	5,000	3,750	3,000
8	1/2	7,000	4,500	3,500	2,700
10	5/8	5,000	3,250	2,500	2,000
12	3/4	5,000	3,250	2,500	2,000
14	7/8	3,750	2,500	1,800	1,500
16	1	3,600	2,400	1,800	1,400
20	1 1/4	3,200	2,100	1,600	1,275
24	1 1/2	3,000	2,000	1,500	1,200
32	2	2,750	1,800	1,350	1,100

†Pressures shown do not apply to pneumatic applications or stainless steel tubing installations.
*Zinc plating discolors at temperatures over 400°F and melts at 750°F.

SPECIALTY & TRUCK HOSE

LOW & MEDIUM PRESSURE HOSE

HIGH PRESSURE HOSE

HOSE FITTINGS

ADAPTERS & TUBE FITTINGS

ACCESSORIES & ASSEMBLY INSTRUCTIONS

HOSE ASSEMBLY EQUIPMENT

APPENDICES

Sleeve-Part No. 7165x

Stainless Steel No. 7176x
(Ref. SAE No. 080115B)

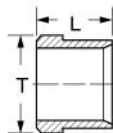

Sleeve-Part No. 8165x



For use with diesel nuts only.

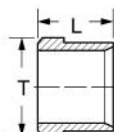

Nut-Part No. 7105x

Stainless Steel No. 7117x
(Ref. SAE No. 080110)

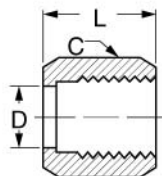

Diesel Nut-Part No. 8112x

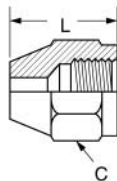
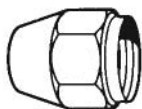

Bulkhead Nut-Part No. 7924x

Stainless Steel No. 7936x
(Ref. SAE No. 080118)

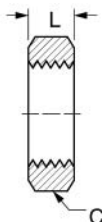

Part Number	Tube O.D.	L	Dia. T
7165x2•	1/8	.28	.20
7165x3•	3/16	.28	.31
7165x4•	1/4	.34	.36
7165x5•	5/16	.34	.42
7165x6•	3/8	.38	.48
7165x8•	1/2	.38	.63
7165x10•	5/8	.42	.75
7165x12•	3/4	.42	.88
7165x14•	7/8	.42	1.00
7165x16•	1	.42	1.13
7165x20•	1 1/4	.42	1.41
7165x24•	1 1/2	.42	1.66
7165x32•	2	.45	2.19

Part Number	Tube O.D.	L	Dia. T
8165x4	1/4	.34	.38
8165x5	5/16	.34	.44
8165x6	3/8	.38	.50

Part Number	Tube O.D.	Hex C	L	D Dia.
7105x2•	1/8	3/8	.53	.132
7105x3•	3/16	7/16	.61	.195
7105x4•	1/4	9/16	.70	.257
7105x5•	5/16	5/8	.72	.320
7105x6•	3/8	1 1/16	.75	.382
7105x8•	1/2	7/8	.84	.508
7105x10•	5/8	1	.92	.634
7105x12•	3/4	1 1/4	.97	.759
7105x14•	7/8	1 3/8	1.00	.884
7105x16•	1	1 1/2	1.05	1.009
7105x20•	1 1/4	2	1.05	1.263
7105x24•	1 1/2	2 1/4	1.03	1.513
7105x32•	2	2 7/8	1.12	2.017

Part Number	Tube O.D.	Thread Number	Hex C	L
8112x4	1/4	9/16-18	3/4	.94
8112x5	5/16	5/8-18	1 3/16	1.00
8112x6	3/8	3/4-16	1 5/16	1.13

Part Number	Tube O.D.	Hex C	L
7924x4•	1/4	1 1/16	.28
7924x6•	3/8	1 3/16	.27
7924x8•	1/2	1	.31
7924x10	5/8	1 1/8	.36
7924x12•	3/4	1 3/8	.41
7924x14	7/8	1 1/2	.41
7924x16•	1	1 5/8	.41

• Available in stainless steel.

All measurements are in inches.

SPECIALTY & TRUCK HOSE

LOW & MEDIUM PRESSURE HOSE

HIGH PRESSURE HOSE

HOSE FITTINGS

ADAPTERS & TUBE FITTINGS

ACCESSORIES

HOSE ASSEMBLY EQUIPMENT

APPENDICES

Cap-Part No. 7129x

Stainless Steel No. 7141x
(Ref. SAE No. 080112)

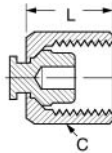
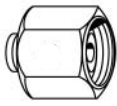

Plug-Part No. 7229x

Stainless Steel No. 7241x
(Ref. SAE No. 080109)

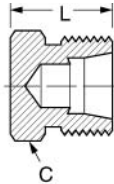

Reducer-Part No. 7015x

Stainless Steel No. 7027x
(Ref. SAE No. 080123)

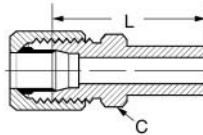
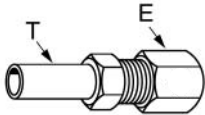

Small Hex Union-Part No. 7305x

Stainless Steel No. 7317x
(Ref. SAE No. 080101)

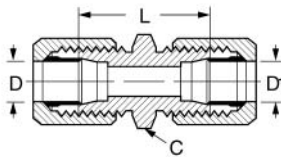
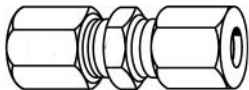

Large Hex Union-Part No. 7306x

Stainless Steel No. 7318x
(Ref. SAE No. 080119)

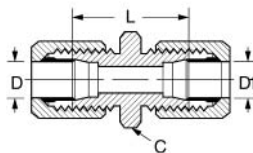
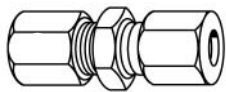

Part Tube Number	O.D.	Hex C	L
7129x4•	1/4	9/16	.70
7129x6•	3/8	1 1/16	.75
7129x8•	1/2	7/8	.84
7129x10•	5/8	1	.92
7129x12•	3/4	1 1/4	.97
7129x16•	1	1 1/2	1.05
7129x20	1 1/4	2	1.05

Part Tube Number	O.D.	Hex C	L
7229x2	1/8	7/16	.63
7229x4•	1/4	1/2	.71
7229x5	5/16	9/16	.71
7229x6•	3/8	5/8	.75
7229x8•	1/2	1 3/16	.85
7229x10	5/8	1 5/16	.97
7229x12•	3/4	1 1/8	1.10
7229x16	1	1 3/8	1.10

Part Number	Body size T	Tube Size E	Hex C	L
7015x6x4•	13/8	1/4	1/2	1.61
7015x8x4•	1/2	1/4	9/16	1.73
7015x8x6•	1/2	3/8	5/8	1.77
7015x10x8•	5/8	1/2	1 3/16	1.96
7015x12x6•	3/4	3/8	1 3/16	1.93
7015x12x8•	3/4	1/2	1 3/16	2.03
7015x16x12•	1	3/4	1 1/8	2.24
7015x20x16•	1 1/4	1	1 3/8	2.28

Part Number	Tube O.D.	Tube O.D.	Hex C	D	D1	I
7305x2•	1/8	1/8	7/16	.093	.093	1.02
7305x3•	3/16	3/16	7/16	.125	.125	1.11
7305x4•	1/4	1/4	1/2	.203	.203	1.18
7305x5•	5/16	5/16	9/16	.234	.234	1.18
7305x6x4•	3/8	1/4	5/8	.281	.203	1.22
7305x6•	3/8	3/8	5/8	.281	.281	1.24
7305x8x6	1/2	3/8	1 3/16	.422	.281	1.33
7305x8•	1/2	1/2	1 3/16	.422	.422	1.42
7305x10•	5/8	5/8	1 5/16	.500	.500	1.61
7305x12•	3/4	3/4	1 1/8	.656	.656	1.81
7305x14	7/8	7/8	1 1/4	.718	.718	1.81
7305x16•	1	1	1 3/8	.875	.875	1.81
7305x20	1 1/4	1 1/4	1 11/16	1.093	1.093	1.89
7305x24	1 1/2	1 1/2	2	1.344	1.344	1.96
7305x32	2	2	2 5/8	1.813	1.813	2.11

Part Number	Tube O.D.	Tube O.D.	Hex C	D	D1	I
7306x4•	1/4	1/4	1 1/16	.203	.203	1.18
7306x6•	3/8	3/8	1 3/16	.281	.281	1.24
7306x8x6•	1/2	3/8	1	.422	.281	1.33
7306x8•	1/2	1/2	1	.422	.422	1.42
7306xx12•	3/4	3/4	1 3/8	.656	.656	1.81
7306x16	1	1	1 5/8	.875	.875	1.81

• Available in stainless steel.

All measurements are in inches.

Bulkhead Union-Part No. 7325x

Stainless Steel No. 7337x (Ref. SAE No. 080601)

Bulkhead nut included, for replacement nuts see page 287.

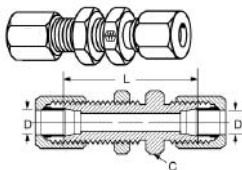

Male Connector-Part No. 7205x

Stainless Steel No. 7217x (Ref. SAE No. 080102))

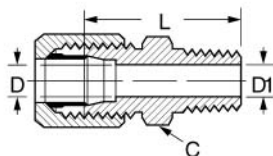
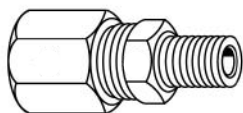

Female Connector-Part No. 7255x

Stainless Steel No. 7267x (Ref. SAE No. 080103)

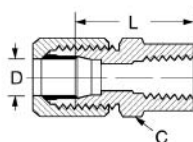

Part Number	Tube O.D.	Hex C	D	L
7325x4•	1/4	1 ¹ / ₁₆	.203	1.89
7325x6•	3/8	1 ³ / ₁₆	.281	1.98
7325x8•	1/2	1	.422	2.22
7325x12•	3/4	1 ³ / ₈	.656	2.72
7325x16	1	1 ⁵ / ₈	.875	2.72

Part Number	Tube O.D.	Male Pipe Thread	Hex C	D1 D	Opt.	L
7205X2•	1/8	1/8	7/16	.093	.188	1.04
7205X2X4•	1/8	1/4	9/16	.093	.281	1.25
7205X3•	3/16	1/8	7/16	.125	.188	1.09
7205X4•	1/4	1/8	1/2	.203	.188	1.12
7205X4X4•	1/4	1/4	9/16	.203	.281	1.32
7205X4X6•	1/4	3/8	3/4	.203	.406	1.33
7205X4X8•	1/4	1/2	7/8	.203	.531	1.58
7205X5•	5/16	1/8	9/16	.234	.188	1.12
7205X5X4•	5/16	1/4	9/16	.234	.281	1.32
7205X6X2•	3/8	1/8	5/8	.281	.188	1.15
7205X6•	3/8	1/4	5/8	.281	.281	1.34
7205X6X6•	3/8	3/8	3/4	.281	.406	1.35
7205X6X8•	3/8	1/2	7/8	.281	.531	1.60
7205X8X4•	1/2	1/4	1 ³ / ₁₆	.422	.281	1.44
7205X8•	1/2	3/8	1 ³ / ₁₆	.422	.406	1.44
7205X8X8•	1/2	1/2	7/8	.422	.531	1.69
7205X8X12•	1/2	3/4	1 ¹ / ₈	.422	.719	1.76
7205X10X6•	5/8	3/8	1 ⁵ / ₁₆	.500	.406	1.56
7205X10•	5/8	1/2	1 ⁵ / ₁₆	.500	.531	1.75
7205X12X8•	3/4	1/2	1 ¹ / ₈	.656	.531	1.88
7205X12•	3/4	3/4	1 ¹ / ₈	.656	.719	1.88
7205X14•	7/8	3/4	1 ¹ / ₄	.718	.719	1.88
7205X16X12•	1	3/4	1 ³ / ₈	.875	.719	1.88
7205X16•	1	1	1 ³ / ₈	.875	.938	2.07
7205X20	1 ¹ / ₄	1 ¹ / ₄	1 ¹¹ / ₁₆	1.093	1.250	2.18
7205X24	1 ¹ / ₂	1 ¹ / ₂	2	1.344	1.500	2.28
7205XX32	2	2	2 ⁵ / ₈	1.813	1.938	2.46

Part Number	Fern Tube O.D.	Pipe Thread	Hex C	D	L
7255x2•	1/8	1/8	9/16	.093	1.05
7255x3•	3/16	1/8	9/16	.125	1.08
7255x4•	1/4	1/8	9/16	.203	1.09
7255x4x4•	1/4	1/4	3/4	.203	1.20
7255x5•	5/16	1/8	9/16	.234	1.08
7255x6•	3/8	1/4	3/4	.281	1.31
7255x6x6•	3/8	3/8	7/8	.281	1.40
7255x8x4•	1/2	1/4	7/8	.422	1.38
7255x8•	1/2	3/8	7/8	.422	1.47
7255x8x8•	1/2	1/2	1 ¹ / ₈	.422	1.63
7255x10	5/8	1/2	1 ¹ / ₈	.500	1.76
7255x12•	3/4	3/4	1 ³ / ₈	.656	1.89
7255x14	7/8	3/4	1 ³ / ₈	.718	1.86
7255x16•	1	1	1 ⁵ / ₈	.875	2.13
7255x20	1 ¹ / ₄	1 ¹ / ₄	2	1.093	2.22

• Available in stainless steel.

All measurements are in inches.

Straight Thread O-Ring Connector-Part No. 7315x

Stainless Steel No. 7327x
(Ref. SAE No. 080120)

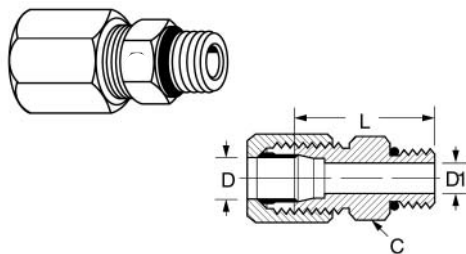

Part Number	Tube O.D.	Port Size	Hex C	D	L	D1 Opt.
7315x3	3/16	3/16	1/2	.125	1.04	-
7315x4•	1/4	1/4	9/16	.203	1.13	-
7315x4x5•	1/4	5/16	5/8	.203	1.13	-
7315x4x6•	1/4	3/8	1 1/16	.203	1.19	.281
7315x5	5/16	5/16	5/8	.234	1.13	-
7315x6•	3/8	3/8	1 1/16	.281	1.21	-
7315x6x8	3/8	1/2	7/8	.281	1.29	.422
7315x8•	1/2	1/2	7/8	.422	1.38	-
7315x8x10	1/2	5/8	1	.422	1.51	.500
7315x8x12•	1/2	3/4	1 1/4	.422	1.67	.656
7315x10•	5/8	5/8	1	.500	1.57	-
7315x12•	3/4	3/4	1 1/4	.656	1.79	-
7315x12x16	3/4	1	1 1/2	.656	1.82	.876
7315x14	7/8	7/8	1 3/8	.718	1.79	-
7315x16x12	1	3/4	1 1/2	.875	1.82	.656
7315x16•	1	1	1 1/2	.875	1.82	-
7315x20	1 1/4	1 1/4	1 7/8	1.093	1.90	-
7315x24	1 1/2	1 1/2	2 1/8	1.344	1.97	-
7315x32	2	2	2 3/4	1.813	2.13	-

45° Male Elbow-Part No. 7355x

Stainless Steel No. 7367x
(Ref. SAE No. 080302)

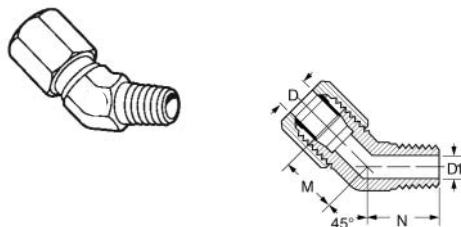

Part Number	Tube O.D.	Male Pipe Thread	D	D1	M	N	Across Flats
7355x4•	1/4	1/8	.203	.188	.70	.64	7/16
7355x4x4•	1/4	1/4	.203	.281	.83	.86	9/16
7355x5	5/16	1/8	.234	.188	.75	.64	9/16
7355x6•	3/8	1/4	.281	.281	.83	.86	9/16
7355x8•	1/2	3/8	.422	.406	.98	.95	3/4
7355x10	5/8	1/2	.500	.531	1.08	1.17	7/8
7355x12	3/4	3/4	.656	.719	1.27	1.20	1 1/16
7355x16	1	1	.875	.938	1.36	1.48	1 5/16

90° Union Elbow-Part No. 7505x

Stainless Steel No. 7517x
(Ref. SAE No. 080201)

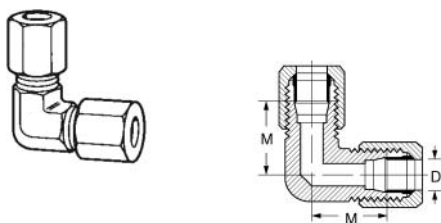

Part Number	Tube O.D.	D	M	Across Flats
7505x4•	1/4	.203	.89	7/16
7505x5	5/16	.234	.95	1/2
7505x6•	3/8	.281	1.05	9/16
7505x8•	1/2	.422	1.25	3/4
7505x10•	5/8	.500	1.42	7/8
7505x12•	3/4	.656	1.58	1 1/16
7505x14•	7/8	.718	1.66	1 5/16
7505x16•	1	.875	1.73	1 5/16
7505x20	1 1/4	1.093	1.89	1 5/8
7505x24	1 1/2	1.346	2.02	1 7/8

• Available in stainless steel.
All measurements are in inches.

SPECIALTY & TRUCK HOSE
 LOW & MEDIUM PRESSURE HOSE
 HIGH PRESSURE HOSE
 HOSE FITTINGS
 ADAPTERS & TUBE FITTINGS
 ACCESSORIES & ASSEMBLY INSTRUCTIONS
 HOSE ASSEMBLY EQUIPMENT
 APPENDICES

90° Male Elbow-Part No. 7405x

Stainless Steel No. 7417x
(Ref. SAE No. 080202)

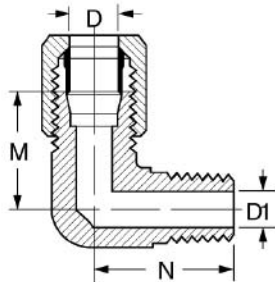
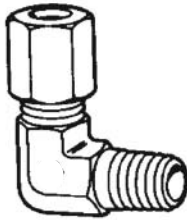

Part Number	Tube O.D.	Male Pipe Thread	D	D1	M	N	Across Flats
7405x2•	1/8	1/8	.093	.188	.77	.72	7/16
7405x3	3/16	1/8	.125	.188	.83	.72	7/16
7405x4•	1/4	1/8	.203	.188	.89	.78	7/16
7405x4x4•	1/4	1/4	.203	.281	1.03	1.09	9/16
7405x5•	5/16	1/8	.234	.188	.95	.81	1/2
7405x5x4•	5/16	1/4	.234	.281	1.03	1.09	9/16
7405x6x2•	3/8	1/8	.281	.188	1.05	.90	9/16
7405x6•	3/8	1/4	.281	.281	1.05	1.09	9/16
7405x6x6•	3/8	3/8	.281	.406	1.16	1.22	3/4
7405x6x8•	3/8	1/2	.281	.531	1.24	1.47	7/8
7405x8x4•	1/2	1/4	.422	.281	1.25	1.22	3/4
7405x8•	1/2	3/8	.422	.406	1.25	1.22	3/4
7405x8x8•	1/2	1/2	.422	.531	1.35	1.47	7/8
7405x10x6•	5/8	3/8	.500	.406	1.42	1.28	7/8
7405x10•	5/8	1/2	.500	.531	1.42	1.47	7/8
7405x12x8	3/4	1/2	.656	.531	1.58	1.59	1 1/16
7405x12•	3/4	3/4	.656	.719	1.58	1.59	1 1/16
7405x14	7/8	3/4	.718	.719	1.62	1.69	1 5/16
7405x16x12	1	3/4	.875	.719	1.73	1.78	1 5/16
7405x16•	1	1	.875	.938	1.73	1.97	1 5/16
7405x20	1 1/4	1 1/4	1.093	1.250	1.89	2.38	1 5/8
7405x24	1 1/2	1 1/2	1.344	1.500	2.02	2.64	1 7/8
7405x32	2	2	1.813	1.938	2.45	3.00	2 9/16

90° Female Elbow-Part No. 7455x

Stainless Steel No. 7467x
(Ref. SAE No. 080203)

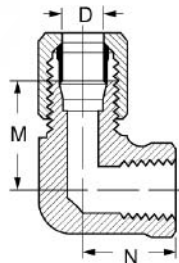
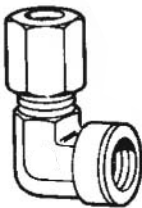

Part Number	Tube O.D.	Fem. Pipe Thread	D	M	N	Across Flats
7455x4•	1/4	1/8	.203	.89	.66	9/16
7455x4x4•	1/4	1/4	.203	1.03	.88	3/4
7455x6•	3/8	1/4	.281	1.05	.88	3/4
7455x6x6•	3/8	3/8	.281	1.14	1.02	7/8
7455x8•	1/2	3/8	.422	1.23	1.02	7/8
7455x8x8•	1/2	1/2	.422	1.35	1.23	1 1/16
7455x10•	5/8	1/2	.500	1.42	1.23	1 1/16
7455x12•	3/4	3/4	.656	1.58	1.36	1 5/16
7455x14	7/8	3/4	.718	1.66	1.42	1 5/16
7455x16	1	1	.875	1.73	1.62	1 5/8

90° Elbow - Straight Thread O-Ring-Part No. 7515x

Stainless Steel No. 7527x
(Ref. SAE No. 080220)

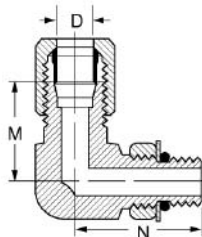
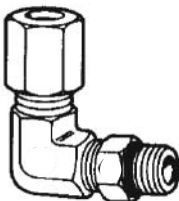

Part Number	Tube O.D.	Port Size	D	M	N	Across Flats
7515x4•	1/4	1/4	.203	.89	1.03	7/16
7515x5	5/16	5/16	.234	.96	1.13	9/16
7515x6•	3/8	3/8	.281	1.05	1.25	9/16
7515x8•	1/2	1/2	.422	1.25	1.45	3/4
7515x10•	5/8	5/8	.500	1.42	1.70	7/8
7515x12•	3/4	3/4	.656	1.58	1.94	1 1/16
7515x16x12	1	3/4	.875	1.73	2.05	1 5/16
7515x16•	1	1	.875	1.73	2.05	1 5/16
7515x20	1 1/4	1 1/4	1.093	1.89	2.25	1 5/8

• Available in stainless steel.

All measurements are in inches.

SPECIALTY & TRUCK HOSE
 LOW & MEDIUM PRESSURE HOSE
 HIGH PRESSURE HOSE
 HOSE FITTINGS
 ADAPTERS & TUBE FITTINGS
 ACCESSORIES & ASSEMBLY INSTRUCTIONS
 HOSE ASSEMBLY EQUIPMENT
 APPENDICES

Union Tee-Part No. 7717x

Stainless Steel No. 7717x
(Ref. SAE No. 080401)

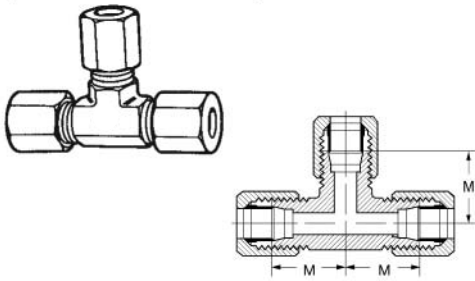

Part Number	Tube O.D.	D	M	Across Flats
7705x3	3/16	.125	.83	7/16
7705x4•	1/4	.203	.89	7/16
7705x5•	5/16	.234	.95	9/16
7705x6•	3/8	.281	1.05	9/16
7705x8•	1/2	.422	1.25	3/4
7705x10•	5/8	.500	1.42	7/8
7705x12•	3/4	.656	1.58	1 1/16
7705x14	7/8	.718	1.62	1 5/16
7705x16•	1	.875	1.73	1 5/16

Male Run Tee-Part No. 7755x

Stainless Steel No. 7767x
(Ref. SAE No. 080424)

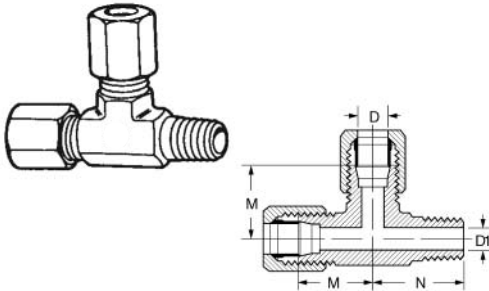

Part Number	Tube O.D.	Male Pipe Thread	D	D1	M	N	Across Flats
7755x4•	1/4	1/8	.203	.188	.89	.78	7/16
7755x4x4x4•	1/4	1/4	.203	.281	1.03	1.09	9/16
7755x6•	3/8	1/4	.281	.281	1.05	1.09	9/16
7755x8	1/2	3/8	.422	.422	1.25	1.22	3/4
7755x8x8x8•	1/2	1/2	.422	.531	1.35	1.47	7/8
7755x10	5/8	1/2	.500	.531	1.42	1.47	7/8
7755x12	3/4	3/4	.656	.719	1.58	1.59	1 1/16
7755x16	1	1	.875	.938	1.73	1.97	1 5/16

Female Run Tee-Part No. 7805x

(Ref. SAE No. 080426)

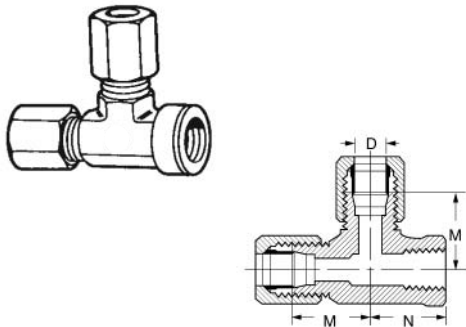

Part Number	Tube O.D.	Fem. Pipe Thread	D	M	N	Across Flats
7805x4	1/4	1/8	.203	.89	.66	9/16
7805x4x4x4	1/4	1/4	.203	1.03	.88	3/4
7805x6	3/8	1/4	.281	1.05	.88	3/4
7805x8	1/2	3/8	.422	1.23	1.02	7/8
7805x10	5/8	1/2	.500	1.42	1.23	1 1/16
7805x12	3/4	3/4	.656	1.58	1.36	1 5/16

Straight Thread O-Ring Run Tee-Part No. 7716x

Stainless Steel No. 7728x
(Ref. SAE No. 080428)

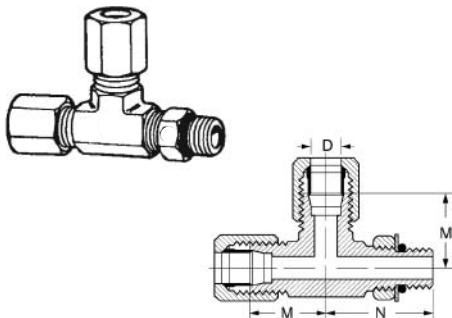

Part Number	Tube O.D.	Port Size	D	M	N	Across Flats
7716x4•	1/4	1/4	.203	.89	1.03	7/16
7716x6•	3/8	3/8	.281	1.05	1.25	9/16
7716x8•	1/2	1/2	.422	1.25	1.45	3/4

• Available in stainless steel.
All measurements are in inches.

Male Branch Tee-Part No. 7605x

Stainless Steel No. 7617x
(Ref. SAE No. 080425)

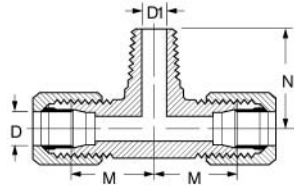
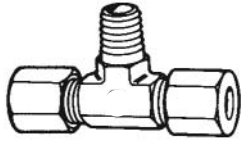

Part Number	Tube O.D.	Male Pipe Thread	D	D1	M	N	Across Flats
7605x4•	1/4	1/8	.203	.188	.89	.78	7/16
7605x4x4x4•	1/4	1/4	.203	.281	1.03	1.09	9/16
7605x5	5/16	1/8	.234	.188	.95	.81	9/16
7605x6•	3/8	1/4	.281	.281	1.05	1.09	9/16
7605x8•	1/2	3/8	.422	.406	1.25	1.22	3/4
7605x8x8x8•	1/2	1/2	.422	.531	1.35	1.47	7/8
7605x10	5/8	1/2	.500	.531	1.42	1.47	7/8
7605x12	3/4	3/4	.656	.719	1.58	1.59	1 1/16
7605x16	1	1	.875	.938	1.73	1.97	1 5/16

SPECIALTY & TRUCK HOSE

LOW & MEDIUM PRESSURE HOSE

HIGH PRESSURE HOSE

Female Branch Tee-Part No. 7655x

Stainless Steel No. 7667x
(Ref. SAE No. 080427)

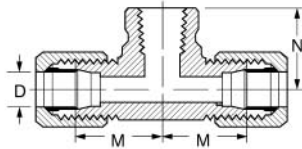
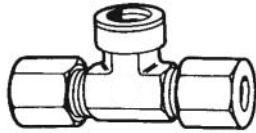

Part Number	Tube O.D.	Fem. Pipe Thread	D	M	N	Across Flats
7655x4•	1/4	1/8	.203	.89	.66	9/16
7655x4x4x4•	1/4	1/4	.203	1.03	.88	3/4
7655x6•	3/8	1/4	.281	1.05	.88	3/4
7655x8•	1/2	3/8	.422	1.23	1.02	7/8
7655x10	5/8	1/2	.500	1.42	1.23	1 1/16
7655x12	3/4	3/4	.656	1.58	1.36	1 5/16
7655x14	7/8	3/4	.718	1.62	1.42	1 5/16
7655x16	1	1	.875	1.73	1.62	1 5/8
7655x20	1 1/4	1 1/4	1.093	2.08	1.70	1 7/8

• Available in stainless steel.

All measurements are in inches.

HOSE FITTINGS

ADAPTERS & TUBE FITTINGS

ACCESSORIES & ASSEMBLY INSTRUCTIONS

HOSE ASSEMBLY EQUIPMENT

APPENDICES

Accessories & Assembly Instructions Index

Alphabetical Index

DESCRIPTION	PAGES
Assembly Equipment	
Crimp	327-331
Reusable	332-336
Assembly Instructions	309-326
Cut Off Equipment	337-339
Proof Test Equipment	341-342
Skiving Equipment	340

Part Number Index

DESCRIPTION	PAGES	PART #	PG.	PART #	PG.	PART #	PG.
Assembly Equipment		583	335	FF13273	299	FT1271	335
Crimp	327-331	624	296	FF13570	299	FT1279	340
Reusable	332-336	1561	335	FF13571	299	FT1281	333
Assembly Instructions	309-326	1562	335	FF90308	297	FT1283	329
Cut Off Equipment	337-339	1563	335	FF90311	297	FT1307	330
Proof Test Equipment	341-342	1582	335	FT1013	333	FT1312	341
Skiving Equipment	340	1597	335	FT1028	334	FT1355-01	296
		1598	335	FT1033	334	FT1330-XL	329
		1599	335	FT1038A	336	FT1380	327
		222005	295	FT1058	342	FT1380P	327
		222022	295	FT1081	336	FT1390	329
		900564	295	FT1090	336	FT1500	337
		900952	295	FT1092	329	HP	298
		900705	295	FT1095	335	HPM	298
		900729	297	FT1097	332	HSM	298
		F2015	336	FT1101	338	HLM	298
		FC425	296	FT1215	339	S1026	339
		FF9075	222, 310	FT1220	335	S1043	339
		FF9217	296	FT1229	340	S1102	339
		FF13267	299	FT1230	340	S1104	338
		FF13268	299	FT1234	334	S1118	339
		FF13269	299	FT1240	340	S1120	339
		FF13270	299	FT1258	337	SC1681	339
		FF13271	299	FT1260	338	SC1709	339
		FF13272	299	FT1261	341	SC1772	338

WARNING

The user must exercise extreme care when operating any Eaton assembly equipment with powered moving components. Safety glasses must be worn at all times when using any Eaton assembly equipment.

Read and understand the owners and operators manual before attempting to operate any equipment.

Eaton personnel are available to answer any questions, please call Eaton Corporation, 14615 Lone Oak Road, Eden Prairie, MN 55344, 952-937-9800.

Eaton assembly equipment is designed to be used only with Aeroquip hose and Eaton hose fittings.



SPECIALTY & TRUCK HOSE
 LOW & MEDIUM PRESSURE HOSE
 HIGH PRESSURE HOSE
 HOSE FITTINGS
 ADAPTERS & TUBE FITTINGS
 ACCESSORIES & ASSEMBLY INSTRUCTIONS
 HOSE ASSEMBLY EQUIPMENT
 APPENDICES

Protective coils, sleeves & clamps

222005*, 222022

Stainless steel internal support coils



Recommended for vacuum service with most hose.

For use with hose: see pages 300-308.

PART NUMBER	COIL O.D.	
	mm	in.
222005-23C	8,6	.34
222005-10C	10,7	.42
222005-21C	12,9	.51
222005-11C	15,2	.60
222022-12C	17,8	.70
222005-13C	18,5	.73
222005-14C	23,9	.94
222022-16C	24,6	.97
222005-15C	30,2	1.19
222022-20C	31,7	1.25
222005-17C	36,6	1.44
222022-24C	38,1	1.50
222005-18C	47,7	1.88
222022-32C	50,0	1.97
222005-19C	62,0	2.44
222022-40C	67,8	2.67
222022-48C	83,0	3.27
222022-60C	108,7	4.28
222022-80C	134,1	5.28

*222005 is 301 stainless steel.

900705

Steel protective coil sleeve



Recommended for use where hose lines are subjected to excessive abrasion, kinking or accidental damage. Construction: spring steel, rust resistant.

This coil should fit snugly to the hose O.D. expanding the coil I.D. (unwind the coil) may be necessary for proper installation.

For use with hose: see pages 300-308.

SLEEVE DASH NO	SLEEVE I.D.	
	mm	in.
-17S	11,2	.44
-1S	12,7	.50
-13S	14,5	.57
-2S	16,0	.63
-3S	19,0	.75
-4S	22,3	.88
-5S	26,2	1.03
-14S	28,7	1.13
-6S	31,0	1.22
-7S	37,3	1.47
-9S	42,9	1.69
-8S	48,5	1.91
-15S	50,8	2.00
-10S	54,1	2.13
-16S	62,0	2.44
-11S	65,0	2.56
-12S	69,8	2.75

900564

Steel protective coil spring

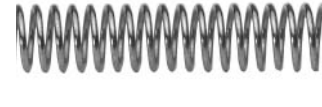

Protects hose cover and reinforcement from abrasion and accidental damage. Construction: steel wire, rust resistant.

This coil should fit snugly to the hose O.D. expanding the coil I.D. (unwind the coil) may be necessary for proper installation.

For use with hose: see pages 300-308.

SLEEVE DASH NO	SLEEVE I.D.	
	mm	in.
-1S	15,5	.61
-12S	17,0	.67
-2S	19,0	.75
-15S	20,6	.81
-14S	21,6	.85
-3S	23,1	.91
-4S	26,4	1.04
-5S	30,0	1.18
-6S	34,0	1.34
-7S	42,2	1.66
-9S	47,5	1.87
-8S	54,1	2.13
-10S	60,4	2.38
-13S	69,8	2.75
-11S	73,1	2.88

900952

Plastic protective coil sleeve



Recommended to protect hose from abrasion, this light weight plastic sleeve is unaffected by air, water, oil, gasoline, hydraulic and most other fluids. This coil can also be used for group bundling of hose lines. Temperature range of 0°F to +180°F.

For use with hose: see pages 300-308.

PART NO	SLEEVE I.D.	
	mm	in.
900952-30	40,0	1.58
900952-22	34,0	1.34
900952-16	27,0	1.06
900952-12	21,0	.83
900952-10	16,0	.63
900952-8	12,5	.49
900952-6	9,5	.37
900952-4	6,0	.24

SPECIALTY & TRUCK HOSE

LOW & MEDIUM PRESSURE HOSE

HIGH PRESSURE HOSE

HOSE FITTINGS

ADAPTERS & TUBE FITTINGS

ACCESSORIES & ASSEMBLY INSTRUCTIONS

HOSE ASSEMBLY EQUIPMENT

APPENDICES

624

Firesleeve



Firesleeve will protect hose from direct flame. Firesleeve is constructed of a uniform single layer of braided fiberglass tubing impregnated with flame resistant silicone rubber. Temperature range of -65°F to +500°F.

For use with hose: see pages 300-308.

PART #	I.D.		CLAMP # (2 required)
	mm	in.	
624-5	7,9	.31	FF9217-0622S
624-7	11,2	.44	FF9217-0622S
624-8	12,7	.50	FF9217-0622S
624-9	14,2	.56	FF9217-0622S
624-10	15,7	.62	FF9217-0622S
624-11	17,5	.69	FF9217-0622S
624-12	19,0	.75	FF9217-0622S
624-13	20,6	.81	FF9217-0622S
624-14	22,3	.88	FF9217-0622S
624-16	25,4	1.00	FF9217-0622S
624-18	28,4	1.12	FF9217-0622S
624-20	31,7	1.25	FF9217-0648S
624-22	35,0	1.38	FF9217-0648S
624-24	38,1	1.50	FF9217-0648S
624-26	41,1	1.62	FF9217-0648S
624-28	44,4	1.75	FF9217-0648S
624-30	47,7	1.88	FF9217-0648S
624-32	50,8	2.00	FF9217-0648S
624-38	60,4	2.38	FF9217-0648S
624-42	66,5	2.62	FF9217-0648S
624-46	73,1	2.88	FF9217-0664C
624-50	79,2	3.12	FF9217-0664C
624-54	85,8	3.38	FF9217-0664C
624-60	95,2	3.75	FF9217-0664C

FC425

Nylon abrasion sleeve Meets MSHA requirements

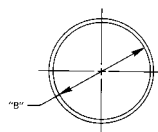

Nylon sleeve protects hose from abrasion and allows bundling of hose lines.

For use with hose: see pages 300-308.

PART #	NOMINAL SLEEVE I.D.* "B"	
	mm	in
FC425-12	18,0	.71
FC425-16	25,4	1.00
FC425-18	28,7	1.13
FC425-20	31,7	1.25
FC425-24	40,4	1.59
FC425-28	44,4	1.75
FC425-32	52,6	2.07
FC425-38	60,4	2.38
FC425-40	64,5	2.54
FC425-46	72,6	2.86
FC425-54	84,8	3.34
FC425-59	93,0	3.66

* The maximum O.D. of hose fittings must be allowed for if fittings are to be covered.

FF9217 Firesleeve clamp



Recommended for attaching 624 Firesleeve to hose lines.

Clamp numbers: FF9217-0622S, FF9217-0648S; 3/8 inch wide, FF9217-0664C; 1/2 inch wide.

For use with hose: see pages 300-308.



Hose Cleaning System

The Jetcleaner™ hose cleaning system offers a revolutionary solution for the internal cleaning of bulk hose and finished hose assemblies. Using a low pressure air gun, the Jetcleaner system routes a foam projectile through the hose to thoroughly remove debris remaining from cutting, skiving and assembly operations. Available in kit form or as individual components, the Jetcleaner hose cleaning system is the system of choice for hose assembly professionals.

Hose Kit (P/N FT1355-01)

Includes:

Jetcleaner pistol, Hose nozzles, 1/4" through 2" ID, Adapter ring, Bench stand, Aluminum case, Quick disconnect coupling

Note: Hose projectiles (P/N FT1355-3-size) not included in kit.

Also available individually:

Jetcleaner pistol – FT1355-1-01

Hose nozzles – FT1355-2-size

Hose projectiles – FT1355-3-size

Coupling nozzles – FT1355-4-size

Coupling projectiles – FT1355-5-size

Adapter ring – FT1355-10-01

Carrying case – FT1355-11-02

Bench stand – FT1355-12-01

SPECIALTY & TRUCK HOSE
LOW & MEDIUM PRESSURE HOSE
HIGH PRESSURE HOSE
HOSE FITTINGS
ADAPTERS & TUBE FITTINGS
ACCESSORIES & ASSEMBLY INSTRUCTIONS
HOSE ASSEMBLY EQUIPMENT
APPENDICES

900729

Support clamp



These lightweight vinyl-coated steel support clamps are designed to support hose where long runs are necessary.

This clamp not only furnishes a cleaner installation, but prevents damage, exposure and chafing.

The lining will withstand high ambient temperatures.

Bolt hole dia: Clamp dash no. -01 thru -8, -18 thru -23 is .406; -9 thru -17, -24 thru -31 is .531.

For use with hose: see pages 300-308.

CLAMP DASH NO.	CLAMP I.D. CLOSED	
	mm	in
-18	6,3	.25
-19	9,6	.38
-01	11,2	.44
-1	12,7	.50
-2	14,2	.56
-21	16,0	.63
-3	17,5	.69
-4	19,0	.75
-5	20,6	.81
-6	23,9	.94
-23	25,4	1.00
-8	26,9	1.06
-9	28,7	1.13
-27	30,2	1.19
-24	31,7	1.25
-25	33,3	1.31
-10	38,1	1.50
-11	39,6	1.56
-12	44,4	1.75
-28	46,0	1.81
-13	50,8	2.00
-29	52,3	2.06
-14	57,1	2.25
-30	63,5	2.50
-31	66,8	2.63
-15	69,8	2.75
-16	73,1	2.88
-17	90,4	3.56

FF90311

Heavy Duty Hose Support Clamps

These heavy duty weld-based clamps are designed to securely hold hose in applications subject to impulsing, flexing and vibrating conditions. The clamps help prevent abrasion and extend hose life through proper routing. Clamps are rated to ambient temperature of +250°F. See pages 300-308 for detailed clamp to hose part number reference.



CLAMP P/N

INSIDE DIAMETER

CLAMP P/N	INSIDE DIAMETER	
	mm	in
FF90311-127	12,7	0.50
FF90311-137	13,7	0.54
FF90311-150	15,0	0.59
FF90311-160	16,0	0.63
FF90311-171	17,1	0.67
FF90311-174	17,4	0.69
FF90311-190	19,0	0.75
FF90311-205	20,5	0.81
FF90311-222	22,2	0.87
FF90311-239	23,9	0.94
FF90311-254	25,4	1.00
FF90311-266	26,6	1.05
FF90311-280	28,0	1.10
FF90311-300	30,0	1.18
FF90311-320	32,0	1.26
FF90311-334	33,4	1.31
FF90311-357	35,7	1.41
FF90311-381	38,1	1.50
FF90311-400	40,0	1.57
FF90311-422	42,2	1.66
FF90311-445	44,5	1.75
FF90311-483	48,3	1.90
FF90311-508	50,8	2.00
FF90311-572	57,2	2.25
FF90311-635	63,5	2.50
FF90311-700	70,0	2.76

FF90308

Hose Insertion Gages

Improve hose assembly reliability with these easy to use aluminum gages that are designed to ensure proper fitting depth during pre-assembly.

Simply bottom the hose in the appropriately marked cavity and scribe a mark on the hose flush with the top surface of the gauge. Insert the fitting until the back of the socket is aligned with scribe line.



For use with all hoses that mate with TTC, TTC12 and Global Spiral TTC fittings

PART NUMBER	USAGE
FF90308-01	For use with all hoses that mate with -4 through -16 TTC and TTC12 fittings
FF90308-02	For use with all hoses that mate with -20 through -32 TTC and TTC 12 fittings
FF90308-03	For use with all hoses that mate with -12, -16, -20 Spiral TTC fittings

SPECIALTY & TRUCK HOSE

LOW & MEDIUM PRESSURE HOSE

HIGH PRESSURE HOSE

HOSE FITTINGS

ADAPTERS & TUBE FITTINGS

ACCESSORIES & ASSEMBLY INSTRUCTIONS

HOSE ASSEMBLY EQUIPMENT

APPENDICES

Hose Protectors

PART NUMBER	DESCRIPTION
HP4*	4" Hose Protector Case of 50
HP6*	6" Hose Protector Case of 50
HP8*	8" Hose Protector Case of 50
HPM*	Mixed Hose Protectors Case of 60

*Hose protectors available in black, orange or yellow.



Abrasion Protection For:

- Hydraulic Hoses
- Battery Cables
- Wiring Harness
- Brake Systems
- Fuel Lines
- Air Lines
- Radiator Hoses
- Oil Lines

Features:

- Extremely high wear factor
- Formulated to resist solvents, oils, grease, gasoline, etc.
- 3 grooves protect cable ties and prevent slipping
- Operating temperature range is -40° to 430°F.
- Exceptionally cost effective
- Easy installation in minutes – no need to remove hose
- Packed in easy to assemble, colorful, counter display box
- Available in 3 sizes – 4", 6" and 8" – cable ties included

Market Applications:

- Farming
- Industrial
- Trucking
- Mining
- Construction
- Aviation Support
- Public Transportation
- Road Maintenance
- Waste Management
- Original Equip. Manuf.

Hose Spacers

PART NUMBER	DESCRIPTION
HSM-48	Case of 48 mixed Hose Spacers

Features:

- Prevents hose abrasion at points of contact
- Helps keep hoses organized
- Prevents damage from unrestrained hoses
- Easy to install
- Available in 4 sizes – 3/4", 1", 1 1/8", 1 3/8"
- Packed in colorful counter display boxes of 48 – cable ties included
- Also available in mixed boxes of 48 (12 each size) or refill bags of 12



Hose Looms

PART NUMBER	DESCRIPTION
HLM-48	Case of 48 mixed Hose Looms

Features:

- Prevents hose abrasion at points of contact
- Keeps multiple hoses organized
- Simplifies hose routing
- Prevents damage from unrestrained hoses
- Easy to install
- Available in 4 sizes – 3/4", 1", 1 1/8", 1 3/8"
- Packed in colorful counter display boxes of 48
- Also available in mixed boxes of 48 (12 each size) or refill bags of 12



SPECIALTY & TRUCK HOSE
 LOW & MEDIUM PRESSURE HOSE
 HIGH PRESSURE HOSE
 HOSE FITTINGS
 ADAPTERS & TUBE FITTINGS
 ACCESSORIES & ASSEMBLY INSTRUCTIONS
 HOSE ASSEMBLY EQUIPMENT
 APPENDICES

Flaretite* Seals

The ideal product to enhance new installations of SAE 37° connections, as well as seal off minor leaks and weeping connections.



Features

- Ribbed insert design
- Coated with Loctite** sealant
- Economical method to reduce minor leaks and weeping connections
- Built-in clip to attach the Flaretite seal to the nose of the SAE 37 degree connection
- Available sizes: -04 through -32

Benefits

- Multiple surface contact points
- Locks the joint and fills surface imperfections
- Saves time & money associated with maintenance and rework
- Quick & easy assembly

Flaretite Seal Joint Section of Applied Seal

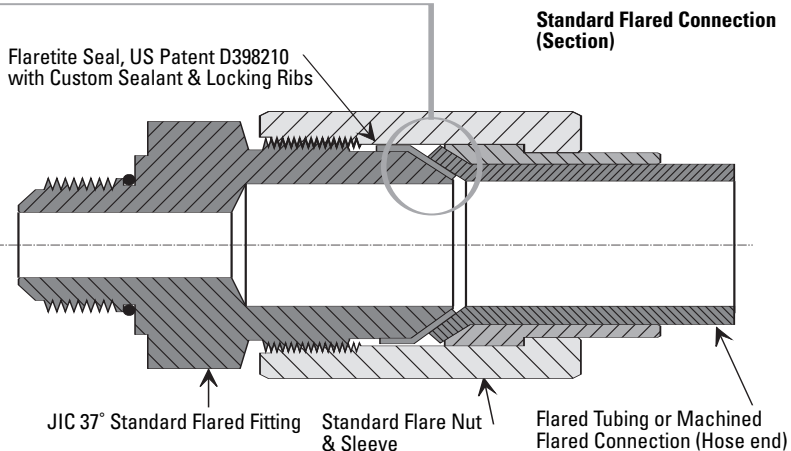
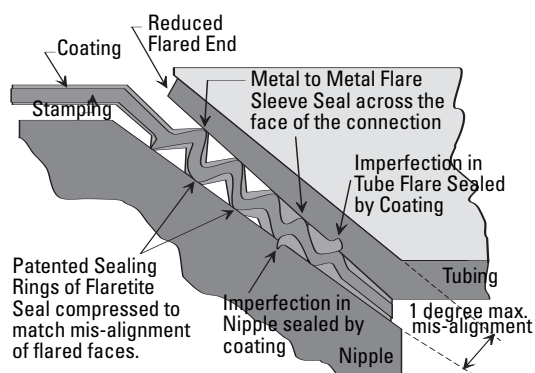

SEAL SIZE	PACKAGE PART NUMBER	NUMBER OF SEALS PER PACKAGE
-04	FF13267	100
-06	FF13268	100
-08	FF13269	100
-10	FF13270	100
-12	FF13271	100
-16	FF13272	50
-20	FF13273	50
-24	FF13570	25
-32	FF13571	10

Assembly and Torque Requirements

To assemble an SAE 37° connection using a Flaretite seal, simply push the Flaretite seal onto the male portion of the connection. The built-in clip will hold the Flaretite seal onto the male half.

During assembly ensure:

- The seal is fitted squarely to the conical nose of the JIC fitting -37° flare.
- The sealing faces of the flared connector part are clean and free of burrs.
- The flared joint is correctly tightened with recommended torque settings noted below.

RECOMMENDED TORQUE SETTINGS:

Tolerance: +10% -0%					
-04 (1/4")	SAE 37°: 14lb-ft.	-10 (5/8")	SAE 37°: 80lb-ft.	-20 (1-1/4")	SAE 37°: 190lb-ft.
-06 (3/8")	SAE 37°: 26lb-ft.	-12 (3/4")	SAE 37°: 110lb-ft.	-24 (1-1/2")	SAE 37°: 220lb-ft.
-08 (1/2")	SAE 37°: 55lb-ft.	-16 (1")	SAE 37°: 140lb-ft.	-32 (2")	SAE 37°: 325lb-ft.

* Flaretite is a registered trademark of Flaretite Inc. All photos and the name Flaretite are the property of Flaretite Inc.

** Loctite is a registered trademark of Henkel Loctite Corporation.

SPECIALTY & TRUCK HOSE

LOW & MEDIUM PRESSURE HOSE

HIGH PRESSURE HOSE

HOSE FITTINGS

ADAPTERS & TUBE FITTINGS

ACCESSORIES & ASSEMBLY INSTRUCTIONS

HOSE ASSEMBLY EQUIPMENT

APPENDICES

Accessories to Hose Chart

SPECIALTY &
TRUCK HOSE

Part #	Steel Prot. Coil Spring* 900564 (dash size)	Plastic Coil Sleeve 900952 (dash size)	Steel Prot. Coil Sleeve* 900705 (dash size)	Support Clamp 900729 (dash size)	Internal Support Coil	Nylon Sleeve* FC425 (dash size)	Firesleeve* 624 (dash size)	Firesleeve Clamp FF9217 (dash size)	Heavy Duty Support Clamp FF9031 (dash size)
302A16	-6S	-16	-6S	-27	222005-14C	-24	-24	-0648S	-320
302A20	-7S	-22	-7S	-10	222005-15C	-28	-30	-0648S	-381
302A24	-9S	-22	-9S	-12	222005-17C	-32	-32	-0648S	-445
302A32	-10S	-30	-10S	-14	222005-18C	-38	-38	-0648S	-572
303-4	-1S	-6	-1S	-1		-12	-11	-0622S	-127
303-5	-12S	-8	-13S	-2		-12	-12	-0622S	-150
303-6	-2S	-10	-2S	-21		-16	-14	-0622S	-174
303-8	-14S	-12	-3S	-4	222005-10C	-16	-16	-0622S	-190
303-10	-4S	-12	-4S	-6	222005-21C	-20	-18	-0630S	-239
303-12	-5S	-16	-5S	-8	222005-13C	-20	-20	-0630S	-280
1503-4	-1S	-6	-1S	-1		-12	-11	-0622S	-137
1503-5	-12S	-8	-13S	-2		-12	-12	-0622S	
1503-6	-2S	-10	-2S	-21		-16	-14	-0622S	-174
1503-8	-14S	-12	-3S	-4	222005-10C	-16	-16	-0622S	-190
1503-10	-4S	-12	-4S	-6	222005-21C	-20	-18	-0630S	-239
1503-12	-5S	-16	-5S	-8	222005-13C	-20	-20	-0630S	-280
1503-16	-6S	-16	-6S	-27	222005-14C	-24	-24	-0648S	-320
1503-20	-7S	-22	-7S	-10	222005-15C	-28	-30	-0648S	-381
1503-24	-9S	-22	-9S	-12	222005-17C	-32	-32	-0648S	-445
1503-32	-10S	-30	-10S	-14	222005-18C	-38	-38	-0648S	-572
1503-40			-12S	-16	222005-19C				
1531-10	-4S	-12	-4S	-6		-20	-16	-0622S	-239
1531-12	-5S	-16	-5S	-8		-20	-20	-0630S	-280
1531-16	-7S	-16	-6S	-25		-24	-24	-0630S	-357
1531-20	-7S	-22	-7S	-10		-28	-30	-0648S	-422
1531A-24	-6S	-16	-5S	-9		-24	-32	-0648S	-483
2550-6	-14S	-10	-3S	-4		-16	-13	-0622S	-174
2554-6	-14S	-10	-2S	-4		-16	-13	-0622S	-174
2555-6	-14S	-10	-2S	-4		-16	-13	-0622S	-190
2556-4	-1S	-6	-1S	-1		-12	-9	-0622S	-127
2556-6	-12S	-8	-13S	-21		-16	-11	-0622S	-160
2556-8	-14S	-10	-3S	-4		-16	-13	-0622S	-190
2556-10	-4S	-12	-4S	-5		-16	-16	-0622S	-222
2556-12	-5S	-16	-5S	-23		-20	-18	-0630S	-266
2565-4	-1S	-6	-1S	-1		-12	-9	-0622S	-127
2565-6	-12S	-8	-13S	-21		-16	-11	-0622S	-160
2565-8	-14S	-10	-3S	-4		-16	-13	-0622S	-205
2565-10	-4S	-12	-4S	-6		-16	-16	-0622S	-239
2565-12	-5S	-16	-5S	-8		-20	-18	-0630S	-280
2570-6	-14S	-10	-3S	-4		-16	-13	-0622S	-174
2570-8	-4S	-12	-4S	-6	222005-11C	-16	-18	-0622S	-190
2570-10	-5S	-16	-5S	-8	222005-13C	-20	-20	-0648S	-239
2575-4	-1S	-6	-1S	-1		-12	-9	-0622S	-127
2575-6	-12S	-8	-13S	-21		-16	-11	-0622S	-160
2575-8	-14S	-10	-3S	-4		-16	-13	-0622S	-190
2575-10	-4S	-12	-4S	-6		-20	-16	-0622S	-222
2575-12	-5S	-16	-5S	-23		-20	-18	-0630S	-266
2580-4	-1S	-6	-1S	-1		-12	-11	-0622S	-127
2580-5	-12S	-8	-13S	-2		-12	-12	-0622S	-150
2580-6	-2S	-10	-2S	-21		-16	-14	-0622S	-174
2580-8	-14S	-12	-3S	-4	222005-10C	-16	-16	-0622S	-190
2580-10	-4S	-12	-4S	-6	222005-21C	-20	-18	-0630S	-239

*Sizes indicated are based on Hose O.D. only. If sleeve is to be placed over fittings, a larger sleeve size may be required, depending on type of fitting used.

LOW & MEDIUM
PRESSURE HOSE

HIGH PRESSURE HOSE

HOSE FITTINGS

ADAPTERS &
TUBE FITTINGS

ACCESSORIES &
ASSEMBLY INSTRUCTIONS

HOSE ASSEMBLY
EQUIPMENT

APPENDICES

Accessories to Hose Chart

Part #	Steel Prot. Coil Spring* 900564 (dash size)	Plastic Coil Sleeve 900952 (dash size)	Steel Prot. Coil Sleeve* 900705 (dash size)	Support Clamp 900729 (dash size)	Internal Support Coil	Nylon Sleeve* FC425 (dash size)	Firesleeve* 624 (dash size)	Firesleeve Clamp FF9217 (dash size)	Heavy Duty Support Clamp FF9031 (dash size)
2580-12	-5S	-16	-5S	-8	222005-13C	-20	-20	-0630S	-280
2580-16	-6S	-16	-6S	-27	222005-14C	-24	-24	-0648S	-320
2580-20	-7S	-22	-7S	-10	222005-15C	-28	-28	-0648S	-381
2580-24	-9S	-22	-9S	-12	222005-17C	-32	-32	-0648S	-445
2580-32	-10S	-30	-10S	-14	222005-18C	-40	-42	-0648S	-572
2583-4	-1S	-8	-1S	-2		-12	-11	-0622S	-150
2583-6	-14S	-10	-3S	-4		-16	-16	-0622S	-190
2583-8	-4S	-12	-4S	-6		-20	-20	-0648S	-239
2583-12	-6S	-16	-14S	-24		-24	-24	-0648S	-320
2583-16	-7S	-22	-7S	-10		-28	-28	-0648S	-381
2583-20	-8S	-22	-9S	-12		-32	-32	-0648S	-445
2651-4	-1S	-6	-1S	-1		-12	-11	-0622S	-137
2651-5	-12S	-8	-13S	-2		-12	-12	-0622S	
2651-6	-2S	-10	-2S	-21		-16	-14	-0622S	-174
2651-8	-14S	-12	-3S	-4	222005-10C	-16	-16	-0622S	-190
2651-10	-4S	-12	-4S	-6	222005-21C	-20	-18	-0630S	-239
2651-12	-5S	-16	-5S	-8	222005-13C	-20	-20	-0630S	-280
2651-16	-6S	-16	-6S	-27	222005-14C	-24	-24	-0648S	-320
2651-20	-7S	-22	-7S	-10	222005-15C	-28	-30	-0648S	-381
2651-24	-9S	-22	-9S	-12	222005-17C	-32	-32	-0648S	-445
2651-32	-10S	-30	-10S	-14	222005-18C	-38	-42	-0648S	-572
2651-40			-12S	-16	222005-19C	-54	-50	-0664C	
2661-12	-6S	-16	-14s	-24		-24	-24	-0630S	-320
2661-16	-7S	-22	-7S	-10		-28	-28	-0648S	-381
2661-20	-8S	-22	-9S	-12		-32	-32	-0648S	-445
2661-24	-10S	-30	-15S	-29		-38	-38	-0648S	-508
2661-32	-13S		-16S	-30		-46	-46	-0664C	-635
2661-40						-54	-54	-0664C	
2661-48							-60		
2661-64									
2681-3	-1S	-6	-1S	-1		-12	-11	-0622S	
2681-4	-12S	-8	-13S	-21		-16	-12	-0622S	-160
2681-5	-2S	-8	-2S	-3		-16	-14	-0630S	
2681-6	-14S	-10	-3S	-4		-16	-18	-0630S	-205
2681-8	-4S	-12	-4S	-5		-20	-20	-0630S	-222
2681-10	-5S	-12	-5S	-23		-20	-20	-0630S	-266
2681-12	-6S	-16	-14S	-27	222005-14C	-24	-22	-0648S	-300
2681-16	-7S	-22	-7S	-10	222005-15C	-28	-28	-0648S	-381
2681-20	-8S	-22	-9S	-28	222005-17C	-32	-38	-0648S	-445
2681-24	-10S	-30	-15S	-29	222005-18C	-38	-38	-0648S	-508
2681-32	-13S	-30	-11S	-31	222005-19C	-46	-46	-0664C	-635
2781-4	-2S	-8	-2S	-3		-16	-14	-0622S	-174
2781-6	-3S	-12	-3S	-5		-16	-16	-0630S	-222
2781-8	-4S	-12	-4S	-6		-20	-18	-0630S	-239
2781-10	-5S	-16	-5S	-8		-20	-20	-0630S	-280
2781-12	-6S	-16	-6S	-24		-24	-26	-0648S	-320
2781-16	-7S	-22	-7S	-11		-28	-30	-0648S	-400
2781-20	-8S	-30	-8S	-13		-38	-38	-0648S	-508
2781-24	-10S	-30	-10S	-14		-40	-42	-0648S	-572
2781-32	-11S	-30	-11S	-15		-54	-46	-0664C	-700
2807-3		-4		-18			-7	-0622S	
2807-4		-4		-18			-8	-0622S	

*Sizes indicated are based on Hose O.D. only. If sleeve is to be placed over fittings, a larger sleeve size may be required, depending on type of fitting used.

Accessories to Hose Chart

SPECIALTY &
TRUCK HOSE

Part #	Steel Prot. Coil Spring* 900564 (dash size)	Plastic Coil Sleeve 900952 (dash size)	Steel Prot. Coil Sleeve* 900705 (dash size)	Support Clamp 900729 (dash size)	Internal Support Coil	Nylon Sleeve* FC425 (dash size)	Firesleeve* 624 (dash size)	Firesleeve Clamp FF9217 (dash size)	Heavy Duty Support Clamp FF9031 (dash size)
2807-5		-4		-19			-9	-0622S	
2807-6		-6	-17S	-01	222005-23C		-10	-0622S	
2807-8	-1S	-8	-1S	-1	222005-10C	-12	-12	-0622S	-137
2807-10	-2S	-8	-3S	-21	222005-21C	-16	-14	-0630S	-160
2807-12	-2S	-10	-3S	-4	222005-13C	-16	-16	-0630S	-190
2807-16	-3S	-12	-5S	-23	222005-14C	-20	-20	-0630S	-266
2807-20	-5S	-16	-6S	-24	222005-15C	-24	-24	-0648S	-320
2808-8	-12S	-6	-1S	-2	222005-10C	-12	-16	-0622S	-150
2808-10	-2S	-8	-2S	-3	222005-21C	-16	-18	-0630S	-174
2808-12	-14S	-10	-3S	-5	222005-13C	-16	-20	-0630S	-205
2808-16	-5S	-16	-5S	-8	222005-14C	-20	-26	-0648S	-280
2808-20	-7S	-16	-6S	-25	222005-15C	-24	-32	-0648S	-334
2808-24	-7S	-22	-7S	-11	222005-17C	-28	-38	-0648S	-422
CR170-4	-1S	-6	-1S	-1		-12	-11	-0622S	
CR170-6	-2S	-10	-2S	-21		-16	-14	-0622S	
CR170-8	-14S	-12	-3S	-4	222005-10C	-16	-16	-0622S	
FC136-06	-3S	-12	-3S	-5		-16	-16	-0630S	-205
FC136-08	-4S	-12	-4S	-6		-20	-18	-0630S	-239
FC136-10	-5S	-16	-5S	-8		-20	-20	-0630S	-280
FC136-12	-6S	-16	-6S	-24		-24	-26	-0630S	-300
FC136-16	-7S	-22	-7S	-11		-28	-28	-0630S	-381
FC136-20	-8S	-22	-8S	-28		-32	-38	-0648S	
FC136-24	-10S	-30	-10S	-29		-38	-38	-0648S	
FC136-32	-13S	-30	-11S	-31		-46	-46	-0664C	
FC194-04	-12S	-8	-13S	-21		-16	-12	-0622S	-160
FC194-06	-14S	-10	-3S	-4		-16	-18	-0622S	-205
FC194-08	-4S	-12	-4S	-5		-20	-20	-0630S	-222
FC194-10	-5S	-12	-5S	-23		-20	-20	-0630S	-266
FC194-12	-6S	-16	-14S	-27		-24	-22	-0648S	-300
FC194-16	-7S	-22	-7S	-10		-28	-26	-0648S	-381
FC194-20	-8S	-22	-9S	-28		-32	-32	-0648S	-445
FC195-04	-2S	-8	-2S	-3		-16	-14	-0622S	-174
FC195-06	-3S	-12	-3S	-5		-16	-16	-0622S	-222
FC195-08	-4S	-12	-4S	-6		-20	-18	-0630S	-239
FC195-10	-5S	-16	-5S	-8		-20	-20	-0630S	-280
FC195-12	-6S	-16	-6S	-24		-24	-26	-0630S	-320
FC195-16	-7S	-22	-7S	-11		-28	-30	-0648S	-400
FC195-20	-8S	-30	-8S	-13		-38	-38	-0648S	-500
FC195-24	-10S	-30	-10S	-14		-38	-42	-0648S	-572
FC195-32	-11S	-30	-11S	-15		-54	-46	-0648S	-700
FC211-04	-1S	-6	-1S	-1		-12	-11	-0622S	-137
FC211-06	-15S	-10	-2S	-3		-16	-14	-0622S	-174
FC211-08	-3S	-10	-3S	-5		-16	-16	-0630S	-205
FC211-12	-5S	-16	-5S	-8		-24	-24	-0630S	-280
FC211-16	-7S	-22	-6S	-25		-24	-24	-0648S	-357
FC212-04	-12S	-8	-13S	-2		-12	-12	-0622S	-150
FC212-06	-14S	-10	-2S	-4		-16	-14	-0630S	-190
FC212-08	-3S	-12	-4S	-5		-16	-18	-0630S	-222
FC212-12	-6S	-16	-14S	-9		-20	-22	-0648S	-300
FC212-16	-7S	-22	-7S	-10		-24	-26	-0648S	-381
FC212-20	-8S	-22	-8S	-28		-32	-32	-0648S	-483

*Sizes indicated are based on Hose O.D. only. If sleeve is to be placed over fittings, a larger sleeve size may be required, depending on type of fitting used.

LOW & MEDIUM
PRESSURE HOSE

HIGH PRESSURE HOSE

HOSE FITTINGS

ADAPTERS &
TUBE FITTINGS

ACCESSORIES &
ASSEMBLY INSTRUCTIONS

HOSE ASSEMBLY
EQUIPMENT

APPENDICES

Accessories to Hose Chart

Part #	Steel Prot. Coil Spring* 900564 (dash size)	Plastic Coil Sleeve 900952 (dash size)	Steel Prot. Coil Sleeve* 900705 (dash size)	Support Clamp 900729 (dash size)	Internal Support Coil	Nylon Sleeve* FC425 (dash size)	Firesleeve* 624 (dash size)	Firesleeve Clamp FF9217 (dash size)	Heavy Duty Support Clamp FF9031 (dash size)
FC212-24	-10S	-30	-10S	-13	222005-18C	-38	-38	-0648S	
FC212-32	-13S	-30	-12S	-30	222005-19C	-46	-46	-0664C	-635
FC234-05	-1S	-10	-2S	-21		-12	-11	-0622S	-150
FC234-06	-2S	-12	-3S	-4		-12	-12	-0622S	-174
FC234-08	-3S	-12	-4S	-4	222005-10C	-16	-12	-0622S	-190
FC234-10	-4S	-16	-5S	-23	222005-21C	-16	-13	-0622S	-239
FC234-12	-5S	-16	-14S	-9	222005-13C	-20	-16	-0630S	-280
FC234-16	-6S	-22	-7S	-24	222005-14C	-20	-20	-0630S	-320
FC252-08									-205
FC252-10									-239
FC252-12									-266
FC252-16									-334
FC 254-08	-4S	-12	-4S	-6		-20	-18	-0630S	-254
FC254-12	-6S	-16	-6S	-24		-24	-26	-0648S	-320
FC254-16	-7S	-22	-7S	-10		-28	-30	-0648S	-381
FC254-20	-8S	-22	-9S	-28		-32	-32	-0648S	-445
FC254-24	-10S	-30	-10S	-29		-38	-38	-0648S	
FC254-32	-10S	-30	-11S	-31		-54	-46	-0664C	-700
FC273-12	-6S	-16	-6S	-24		-24	-26	-0648S	-320
FC273-16	-7S	-22	-7S	-10		-28	-30	-0648S	-381
FC273-20	-8S	-30	-8S	-13		-38	-38	-0648S	-508
FC273-24	-10S	-30	-10S	-14		-40	-42	-0664C	-572
FC273-32	-11S			-16		-54	-46	-0664C	-700
FC300-04	-1S	-6	-1S	-1		-12	-11	-0622S	-137
FC300-05	-12S	-8	-13S	-2		-12	-12	-0622S	
FC300-06	-2S	-10	-2S	-21		-16	-14	-0622S	-174
FC300-08	-14S	-12	-3S	-4	222005-10C	-16	-16	-0622S	-190
FC300-10	-4S	-12	-4S	-6	222005-21C	-20	-18	-0630S	-239
FC300-12	-5S	-16	-5S	-8	222005-13C	-20	-20	-0630S	-280
FC300-16	-6S	-16	-6S	-27	222005-14C	-24	-24	-0648S	-320
FC300-20	-7S	-22	-7S	-10	222005-15C	-28	-30	-0648S	-381
FC300-24	-9S	-22	-9S	-12	222005-17C	-32	-32	-0648S	-445
FC300-32	-10S	-30	-10S	-14	222005-18C	-38	-38	-0648S	-572
FC300-40			-12S	-16	222005-19C				
FC310-04	-12S	-6	-1S	-2		-12	-12	-0622S	-137
FC310-06	-14S	-10	-2S	-4		-12	-16	-0622S	-174
FC310-08	-3S	-12	-3S	-5		-16	-16	-0630S	-205
FC310-10	-4S	-12	-4S	-6		-20	-18	-0630S	-239
FC310-12	-5S	-16	-5S	-8		-20	-22	-0630S	-280
FC310-16	-7S	-16	-6S	-25		-24	-24	-0648S	-357
FC310-20	-9S	-30	-8S	-12		-32	-30	-0648S	-422
FC318-12	-6S	-16	-14s	-24		-24	-24	-0630S	-320
FC321-04	-1S	-6	-1S	-1		-12	-11	-0622S	-137
FC321-05	-12S	-8	-13S	-2		-12	-12	-0622S	-150
FC321-06	-2S	-10	-2S	-21		-16	-14	-0622S	-174
FC321-08	-14S	-12	-3S	-4	222005-10C	-16	-16	-0622S	-190
FC321-10	-4S	-12	-4S	-5	222005-11C	-20	-18	-0630S	-239
FC321-12	-5S	-16	-5S	-8	222005-13C	-20	-20	-0630S	-280
FC321-16	-6S	-16	-6S	-27	222005-14C	-24	-22	-0630S	-320
FC323-12	-5S	-16	-14S	-27		-24	-24	-0643S	-300
FC323-16	-6S	-22	-7S	-25		-28	-28	-0643S	-381
FC323-20	-8S	-30	-15S	-28		-32	-32	-0648S	
FC323-24	-10S	-30	-10S	-29		-38	-38	-0648S	

*Sizes indicated are based on Hose O.D. only. If sleeve is to be placed over fittings, a larger sleeve size may be required, depending on type of fitting used.

Accessories to Hose Chart

SPECIALTY &
TRUCK HOSE

Part #	Steel Prot. Coil Spring* 900564 (dash size)	Plastic Coil Sleeve 900952 (dash size)	Steel Prot. Coil Sleeve* 900705 (dash size)	Support Clamp 900729 (dash size)	Internal Support Coil	Nylon Sleeve* FC425 (dash size)	Firesleeve* 624 (dash size)	Firesleeve Clamp FF9217 (dash size)	Heavy Duty Support Clamp FF9031 (dash size)
--------	---	--	---	----------------------------------	-----------------------	---------------------------------	-----------------------------	-------------------------------------	---

LOW & MEDIUM
PRESSURE HOSE

FC323-32	-13S	-30	-11S	-31		-46	-46	-0664C	
FC324-08	-4S	-12	-4S	-6		-20	-18	-0622S	-239
FC324-12	-6S	-16	-14S	-27		-24	-26	-0648S	-300
FC324-16	-7S	-22	-7S	-10		-28	-30	-0648S	-381
FC325-12	-6S	-16	-6S	-24		-24	-26	-0648S	-320
FC325-16	-7S	-22	-7S	-10		-28	-30	-0648S	-381
FC332-04	-1S	-6	-1S			-12	-9	-0622S	-127
FC332-06	-12S	-8	-13S	-21		-16	-11	-0622S	-160
FC332-08	-14S	-10	-3S	-4		-16	-13	-0622S	-190
FC332-10	-3S	-12	-4S	-5		-20	-16	-0622S	-222
FC332-12	-5S	-12	-5S	-23		-20	-18	-0630S	-266
FC350-04	-1S	-6	-1S	-1		-12	-11	-0622S	-127
FC350-05	-12S	-8	-13S	-2		-12	-12	-0622S	-150
FC350-06	-2S	-10	-2S	-21		-16	-14	-0622S	-174
FC350-08	-14S	-12	-3S	-4	222005-10C	-16	-16	-0622S	-190
FC350-10	-4S	-12	-4S	-6	222005-21C	-20	-18	-0630S	-239
FC350-12	-16S	-5	-5S	-8	222005-13C	-20	-20	-0630S	-280
FC350-16	-6S	-16	-6S	-27	222005-14C	-24	-24	-0648S	-320
FC350-20	-7S	-22	-7S	-10	222005-15C	-28	-30	-0648S	-381
FC350-24	-9S	-22	-9S	-12	222005-17C	-32	-32	-0648S	-445

HIGH PRESSURE HOSE

FC352-08									-239
FC352-10									-266
FC352-12									-300
FC352-14									-334
FC352-16									-357
FC352-18									-400
FC352-20									-422
FC352-22									-445
FC352-24									-508
FC352-26									-508
FC352-28									-572
FC352-32									-635
FC352-36									-700
FC352-38									
FC352-40									
FC352-44									
FC352-48									
FC352-56									
FC352-64									

HOSE FITTINGS

ADAPTERS &
TUBE FITTINGS

FC355-04	-1S	-6	-1S	-1		-12	-11	-0622S	-127
FC355-05	-1S	-6	-2S	-1		-12	-11	-0622S	-150
FC355-06	-12S	-8	-1S	-2		-12	-12	-0622S	-174
FC355-08	-2S	-10	-13S	-3		-16	-12	-0622S	-190
FC355-10	-3S	-12	-3S	-5	222005-10C	-16	-13	-0622S	-239
FC355-12	-4S	-6	-5S-4S	-6	222005-21C	-20	-16	-0630S	-280
FC355-16	-5S	-16	-6S	-9	222005-13C	-20	-20	-0630S	-320
FC355-20	-6S	-22	-7S	-24	222005-14C	-24	-22	-0648S	-381
FC355-24	-7S	-22	-7S	-10	222005-15C	-28	-30	-0648S	-445
FC355-32	-9S	-22	-9S	-12	222005-17C	-32	-32	-0648S	-572
FC363-08	-15S	-10	-4S	-5		-16	-14	-0622S	-190
FC363-12	-5S	-16	-6S	-8		-20	-20	-0630S	-266

ACCESSORIES &
ASSEMBLY INSTRUCTIONS

HOSE ASSEMBLY
EQUIPMENT

APPENDICES

FC355-04	-1S	-6	-1S	-1		-12	-11	-0622S	-127
FC355-05	-1S	-6	-2S	-1		-12	-11	-0622S	-150
FC355-06	-12S	-8	-1S	-2		-12	-12	-0622S	-174
FC355-08	-2S	-10	-13S	-3		-16	-12	-0622S	-190
FC355-10	-3S	-12	-3S	-5	222005-10C	-16	-13	-0622S	-239
FC355-12	-4S	-6	-5S-4S	-6	222005-21C	-20	-16	-0630S	-280
FC355-16	-5S	-16	-6S	-9	222005-13C	-20	-20	-0630S	-320
FC355-20	-6S	-22	-7S	-24	222005-14C	-24	-22	-0648S	-381
FC355-24	-7S	-22	-7S	-10	222005-15C	-28	-30	-0648S	-445
FC355-32	-9S	-22	-9S	-12	222005-17C	-32	-32	-0648S	-572
FC363-08	-15S	-10	-4S	-5		-16	-14	-0622S	-190
FC363-12	-5S	-16	-6S	-8		-20	-20	-0630S	-266

*Sizes indicated are based on Hose O.D. only. If sleeve is to be placed over fittings, a larger sleeve size may be required, depending on type of fitting used.

Accessories to Hose Chart

Part #	Steel Prot. Coil Spring* 900564 (dash size)	Plastic Coil Sleeve 900952 (dash size)	Steel Prot. Coil Sleeve* 900705 (dash size)	Support Clamp 900729 (dash size)	Internal Support Coil	Nylon Sleeve* FC425 (dash size)	Firesleeve* 624 (dash size)	Firesleeve Clamp FF9217 (dash size)	Heavy Duty Support Clamp FF9031 (dash size)
FC363-16	-6S	-16	-7S	-10		-24	-22	-0630S	-320
FC363-20	-7S	-22	-9S	-11		-28	-26	-0648S	-381
FC363-24	-9S	-22	-8S	-2S		-32	-30	-0648S	-445
FC363-32	-10S		-16S	-30		-59	-42	-0648S	-572
FC364-08	-15S	-10	-4S	-5		-16	-14	-0622S	-190
FC364-12	-5S	-16	-6S	-8		-20	-20	-0630S	-266
FC364-16	-6S	-22	-7S	-10		-24	-22	-0630S	-320
FC364-20	-7S	-30	-9S	-11		-28	-26	-0648S	-381
FC364-24	-9S	-30	-8S	-28		-32	-30	-0648S	-445
FC364-32	-10S		-16S	-30		-59	-42	-0648S	-572
FC364-40	-11S	-30	-12S	-16		-54	-50	-0664S	-635
FC364-48									
FC465-03		-4		-18			-9	-0622S	
FC465-04		-4		-18			-9	-0622S	
FC465-05		-4		-19			-10	-0622S	
FC465-06		-6		-01	222005-23C	-12	-11	-0622S	
FC465-08	-1S	-8	-1S	-1	222005-10C	-12	-13	-0622S	-137
FC465-10	-1S	-8	-13S	-21	222005-21C	-16	-14	-0622S	-160
FC465-12	-2S	-10	-3S	-4	222005-13C	-16	-16	-0622S	-190
FC465-16	-3S	-12	-5S	-23	222005-14C	-20	-20	-0648S	-266
FC465-20	-5S	-16	-6S	-24	222005-15C	-24	-24	-0648S	-320
FC466-04	-1S	-6	-1S	-1		-12	-9	-0622S	-127
FC466-06	-12S	-8	-13S	-21		-16	-11	-0622S	-160
FC466-08	-14S	-10	-3S	-4		-16	-13	-0622S	-190
FC466-10	-3S	-12	-4S	-5		-20	-16	-0622S	-222
FC466-12	-5S	-12	-5S	-23		-20	-18	-0630S	-266
FC469-06	-1S	-6	-1S	-1	222005-23C	-12	-12	-0622S	
FC469-08	-1S	-8	-13S	-21	222005-10C	-16	-14	-0622S	
FC469-10	-12S	-10	-2S	-4	222005-21C	-16	-16	-0622S	-150
FC498-04	-1S	-6	-1S	-1		-12	-9	-0622S	-127
FC498-06	-12S	-8	-13S	-21		-16	-11	-0622S	-160
FC498-08	-14S	-10	-3S	-4		-16	-13	-0622S	-190
FC498-10	-4S	-12	-4S	-5		-20	-16	-0622S	-222
FC498-12	-5S	-12	-5S	-23		-20	-18	-0630S	-266
FC510-04	-12S	-6	-1S	-2		-12	-12	-0622S	
FC510-06	-14S	-10	-2S	-4		-16	-16	-0622S	-174
FC510-08	-3S	-12	-3S	-5		-16	-16	-0630S	-205
FC510-10	-4S	-12	-4S	-6		-20	-18	-0630S	-239
FC510-12	-5S	-16	-5S	-8		-20	-22	-0630S	-280
FC510-16	-7S	-16	-6S	-25		-24	-24	-0630S	-334
FC510-20	-9S	-30	-8S	-12		-32	-30	-0648S	-422
FC563-08	-15S	-12	-3S	-5		-16	-16	-0622S	-205
FC563-12	-5S	-16	-14S	-9		-20	-22	-0648S	-280
FC563-16	-6S	-16	-6S	-2S		-24	-26	-0648S	-334
FC563-20	-7S	-22	-7S	-11		-28	-30	-0648S	
FC563-24	-9S	-22	-9S	-28		-32	-32	-0648S	
FC563-32	-10S	-30	-10S	-14		-40	-42	-0648S	
FC579-04	-2S	-8	-2S	-3		-16	-14	-0622S	-174
FC606-16	-7S	-22	-7S	-10	222005-15C	-28	-30	-0648S	-422
FC606-20	-8S	-30	-8S	-13	222005-17C	-38	-38	-0648S	-508
FC606-24	-10S	-30	-10S	-14	222005-18C	-40	-42	-0648S	-572
FC611-04	-1S	-6	-1S	-1		-12	-11	-0622S	-137

*Sizes indicated are based on Hose O.D. only. If sleeve is to be placed over fittings, a larger sleeve size may be required, depending on type of fitting used.

Accessories to Hose Chart

SPECIALTY & TRUCK HOSE

LOW & MEDIUM PRESSURE HOSE

HIGH PRESSURE HOSE

HOSE FITTINGS

ADAPTERS & TUBE FITTINGS

ACCESSORIES & ASSEMBLY INSTRUCTIONS

HOSE ASSEMBLY EQUIPMENT

APPENDICES

Part #	Steel Prot. Coil Spring* 900564 (dash size)	Plastic Coil Sleeve 900952 (dash size)	Steel Prot. Coil Sleeve* 900705 (dash size)	Support Clamp 900729 (dash size)	Internal Support Coil	Nylon Sleeve* FC425 (dash size)	Firesleeve* 624 (dash size)	Firesleeve Clamp FF9217 (dash size)	Heavy Duty Support Clamp FF9031 (dash size)
FC611-06	-15S	-10	-2S	-3		-16	-14	-0622S	-174
FC611-08	-3S	-10	-3S	-5		-16	-16	-0630S	-205
FC611-12	-5S	-16	-5S	-8		-24	-24	-0630S	-280
FC611-16	-7S	-22	-6S	-25		-24	-24	-0648S	-357
FC611-20	-9S	-30	-8S	-12		-32	-30	-0648S	-422
FC611-24	-8S	-30	-8S	-13		-38	-38	-0648S	-483
FC611-32	-13S	-30	-12S	-30	222005-19C	-46	-46	-0664C	-635
FC619-12	-6S	-16	-6S	-27		-24	-26	-0648S	-300
FC619-16	-6S	-22	-7S	-25		-28	-28	-0643S	-381
FC619-20	-8S	-22	-9S	-12		-32	-32	-0648S	-445
FC619-24	-10S	-30	-15S	-29		-38	-38	-0648S	-508
FC619-32	-13S		-16S	-30		-46	-46	-0664C	-635
FC636-12	-5S	-16	-14S	-27		-24	-24	0643S	-300
FC636-16	-6S	-22	-7S	-25		-28	-28	-0643S	-381
FC636-20	-8S	-22	-10S	-28	222005-17C	-32	-38	-0648S	
FC636-24	-8S	-30	-10S	-29	222005-18C	-38	-38	-0648S	
FC639-04	-1S	-6	-1S	-1		-12	-11	-0622S	-137
FC639-06	-2S	-10	-2S	-3		-16	-14	-0622S	-174
FC639-08	-15S	-10	-3S	-5		-16	-16	-0622S	-205
FC639-10	-54S	-16	-5S	-6		-20	-20	-0630S	-239
FC639-12	-5S	-16	-6S	-9	222005-14C	-22	-22	-0648S	-280
FC639-16	-7S	-22	-7S	-10	222005-15C	-24	-28	-0648S	-357
FC645-06		-6	-17S	-01	222005-23C		-10	-0622S	
FC647-04	-1S	-6	-1S	-1		-12	-9	-0622S	-127
FC647-06	-12S	-8	-13S	-21		-16	-11	-0622S	-160
FC647-08	-14S	-10	-3S	-4		-16	-13	-0622S	-190
FC647-10	-3S	-12	-4S	-5		-20	-16	-0622S	-222
FC647-12	-5S	-12	-5S	-23		-20	-18	-0630S	-266
FC650-04	-1S	-6	-1S	-1		-12	-11	-0622S	
FC650-06	-2S	-10	-2S	-21		-16	-14	-0622S	-160
FC650-08	-14S	-12	-3S	-4	222005-10C	-16	-16	-0622S	-190
FC650-10		-12	-3S	-5		-16	-16	-0622S	-205
FC650-12	-54S	-16	-5S	-6		-20	-20	-0630S	-254
FC659-06	-3S	-12	-3S	-5		-16	-16	-0630S	-205
FC659-08	-4S	-12	-4S	-6		-20	-18	-0630S	-239
FC659-10	-5S	-16	-5S	-8		-20	-20	-0630S	-280
FC659-12	-6S	-16	-6S	-24		-24	-26	-0630S	-300
FC659-16	-7S	-22	-7S	-11		-28	-28	-0630S	-381
FC659-20	-8S	-22	-8S	-28		-32			
FC693-04	-1S	-8	-13S	-2		-12	-12	0622S	
FC693-06	-1S	-10	-2S	-4		-16	-16	-0622S	
FC693-08	-3S	-12	-3S	-5		-18	-18	-0622S	
FC699-04	-12S	-6	-1S	-2		-12	-12	-0622S	
FC699-06	-14S	-10	-2S	-4		-16	-16	-0622S	-174
FC699-08	-3S	-12	-3S	-5		-16	-16	-0630S	-205
FC699-10	-4S	-12	-4S	-6		-20	-18	-0630S	-239
FC699-12	-5S	-16	-5S	-8		-20	-22	-0630S	-280
FC735-16	-7S	-22	-7S	-10	222005-15C	-24	-28	-0648S	-357
FC736-06	-3S	-12	-3S	-5		-16	-16	-0630S	-205
FC736-08	-4S	-12	-4S	-6		-20	-18	-0630S	-239
FC736-10	-5S	-16	-5S	-8		-20	-20	-0630S	-280
FC736-12	-6S	-16	-6S	-24		-24	-26	-0630S	-300

*Sizes indicated are based on Hose O.D. only. If sleeve is to be placed over fittings, a larger sleeve size may be required, depending on type of fitting used.

Accessories to Hose Chart

Part #	Steel Prot. Coil Spring* 900564 (dash size)	Plastic Coil Sleeve 900952 (dash size)	Steel Prot. Coil Sleeve* 900705 (dash size)	Support Clamp 900729 (dash size)	Internal Support Coil	Nylon Sleeve* FC425 (dash size)	Firesleeve* 624 (dash size)	Firesleeve Clamp FF9217 (dash size)	Heavy Duty Support Clamp FF9031 (dash size)
FC736-16	-7S	-22	-7S	-11		-28	-28	-0630S	-381
FC736-20	-8S	-22	-8S	-28		-32	-30	-0648S	
GH120-4	-1S	-8	-13S	-2		-12	-12	-0622S	-137
GH120-6	-2S	-10	-2S	-3		-16	-16	-0622S	-171
GH120-8	-14S	-12	-3S	-5		-16	-18	-0622S	-205
GH120-10	-54S	-16	-5S	-6		-20	-20	-0630S	-239
GH120-12	-5S	-16	-6S	-9		-22	-22	-0648S	-280
GH120-16	-7S	-22	-7S	-10		-24	-28	-0648S	-357
GH120-20	-9S	-30	-8S			-32	-30	-0648S	-422
GH120-24	-10S	-30	-15S	-29		-38	-38	-0648S	-508
GH120-32	-13S	-30	-12S	-30		-46	-46	-0664C	-635
GH194-4	-1S	-6	-1S	-1		-12	-11	-0622S	-137
GH194-6	-2S	-10	-2S	-3		-16	-14	-0622S	-174
GH194-8	-15S	-10	-3S	-5		-16	-16	-0622S	-205
GH194-12	-4S	-12	-4S	-6		-20	-18	-0633S	
GH194-10	-4S	-12	-4S	-6		-20	-18	-0630S	-239
GH194-12	-5S	-16	-5S	-8		-24	-22	-0648S	-280
GH194-16	-6S	-22	-6S	-25		-24	-26	-0648S	-357
GH194-20	-9S	-30	-8S	-1		-32	-30	-0648S	-445
GH195-4	-1S	-8	-13S	-2		-12	-12	-0622S	-150
GH195-6	-1S	-10	-2S	-4		-16	-16	-0622S	-190
GH195-8	-3S	-12	-3S	-5		-18	-18	-0622S	-222
GH195-10	-54S	-16	-5S	-6		-20	-20	-0630S	-266
GH195-12	-5S	-16	-6S	-9		-22	-22	-0648S	-300
GH195-16	-7S	-22	-9S	-10		-28	-28	-0648S	-381
GH195-20	-8S	-30	-10S	-12		-32	-32	-0664C	-483
GH195-24	-10S	-30	-11S	-13		-38	-38	-0648S	
GH195-32	-13S	-30	-12S	-30		-46	-46	-0664C	-635
GH466-20	-8S	-30	-8S	-13		-38	-38	-0648S	-508
GH493-6	-15S	-12	-3S	-5		-16	-16	-0622S	-205
GH493-8	-3S	-12	-4S	-6		-20	-20	-0648S	-239
GH493-10	-4S	-16	-5S	-8		-20	-22	-0648S	-280
GH493-12	-5S	-16	-6S	-27		-24	-24	-0648S	-300
GH493-16	-7S	-22	-7S	-10		-28	-28	-0648S	-381
GH493-20	-8S	-22	-10S	-28		-32	-38	-0648S	
GH493-24	-8S	-30	-10S	-29		-38	-38	-0648S	
GH493-32	-13S	-30	-11S	-31		-46	-46	-0664S	
GH506-12	-6S	-16	-6S	-24		-24	-26	-0648S	-320
GH506-16	-7S	-22	-7S	-10		-28	-30	-0648S	-381
GH506-20	-8S	-22	-9S	-28		-32	-32	-0648S	-445
GH663-4	-1S	-6	-1S	-1		-12	-11	-0622S	-137
GH663-6	-2S	-10	-2S	-3		-16	-14	-0622S	-174
GH663-8	-15S	-10	-3S	-5		-16	-16	-0622S	-205
GH663-12	-5S	-16	-5S	-8		-24	-22	-0648S	-280
GH663-16	-7S	-22	-6S	-25		-24	-26	-0648S	-357
GH663-20	-9S	-30	-8S	-12		-32	-30	-0648S	-422
GH663-24	-8S	-30	-8S	-13		-38	-38	-0648S	-483
GH663-32	-13S	-30	-12S	-30		-46	-46	-0664C	-635
GH681-4	-1S	-6	-1S	-1		-12	-11	-0622S	-127
GH681-6	-12S	-10	-2S	-21		-16	-14	-0622S	-160
GH681-8	-14S	-12	-3S	-4		-16	-16	-0622S	-205
GH781-4	-1S	-8	-13S	-2		-12	-12	-0622S	-137

*Sizes indicated are based on Hose O.D. only. If sleeve is to be placed over fittings, a larger sleeve size may be required, depending on type of fitting used.

Accessories to Hose Chart

Part #	Steel Prot. Coil Spring* 900564 (dash size)	Plastic Coil Sleeve 900952 (dash size)	Steel Prot. Coil Sleeve* 900705 (dash size)	Support Clamp 900729 (dash size)	Internal Support Coil	Nylon Sleeve* FC425 (dash size)	Firesleeve* 624 (dash size)	Firesleeve Clamp FF9217 (dash size)	Heavy Duty Support Clamp FF9031 (dash size)
GH781-6	-2S	-10	-2S	-3		-16	-16	-0622S	-174
GH781-8	-14S	-12	-3S	-5		-16	-18	-0622S	-205
GH781-10	-4S	-12	-5S	-6		-20	-18	-0630S	-239
GH781-12	-5S	-16	-14S	-9		-24	-22	-0648S	-280
GH781-16	-7S	-22	-7S	-10		-24	-28	-0648S	-357
GH781-20	-7S	-22	-9S	-12		-28	-28	-0648S	-422
GH781-24	-8S	-30	-8S	-13		-38	-38	-0648S	-508
GH781-32	-13S	-30	-12S	-30		-46	-46	-0664C	-635
GH793-4	-1S	-8	-13S	-2		-12	-12	-0622S	-150
GH793-6	-15S	-10	-2S	-4		-16	-16	-0622S	-190
GH793-8	-3S	-12	-3S	-5		-16	-18	-0622S	-222
GH793-10	-4S	-16	-5S	-6		-20	-20	-0630S	-266
GH793-12	-5S	-16	-6S	-9		-20	-22	-0648S	-300
GH793-16	-7S	-22	-9S	-10		-24	-28	-0648S	-381
GH793-20	-8S	-30	-10S	-12		-32	-32	-0664C	-483
GH793-24	-10S	-30	-10S	-13		-38	-38	-0648S	
GH793-32	-13S	-30	-12S	-30		-46	-46	-0664C	-635

*Sizes indicated are based on Hose O.D. only. If sleeve is to be placed over fittings, a larger sleeve size may be required, depending on type of fitting used.

SPECIALTY & TRUCK HOSE
LOW & MEDIUM PRESSURE HOSE
HIGH PRESSURE HOSE
HOSE FITTINGS
ADAPTERS & TUBE FITTINGS
ACCESSORIES & ASSEMBLY INSTRUCTIONS
HOSE ASSEMBLY EQUIPMENT
APPENDICES

Assembly Instructions

How to Braze Lifesaver Reusable Fittings

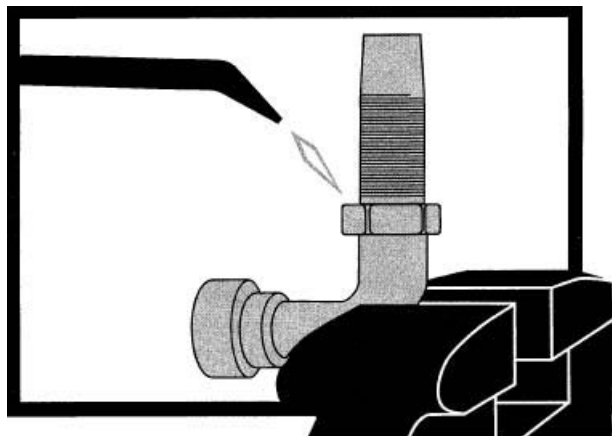

Materials needed:

- Eaton FF9705 silver braze rings or 1/16" diameter 45% silver alloy braze wire
- Water-soluble flux
- Brazing outfit capable of +1200°F (propane or mapp gas)
- Small files – rattail and flat
- Spray paint (quick drying)
- Water (to cool joint)
- Needle-nose pliers
- Tape measure
- Emery paper
- Hacksaw
- Pliers
- Pair of diagonals (or other tool to cut silver wire)
- Residue-free degreasing agent
- Wire brush

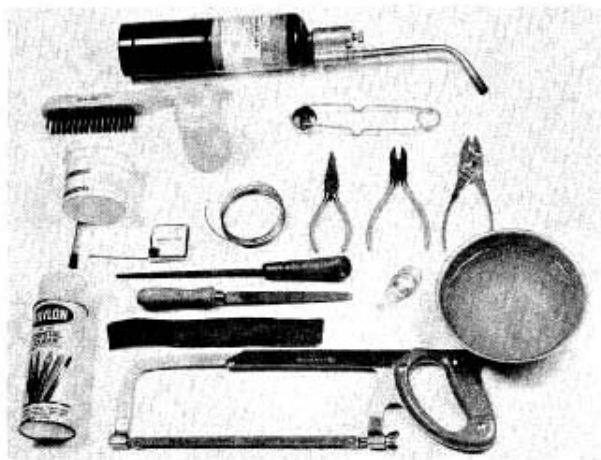

Brazing and assembling Lifesaver reusable fittings is a simple process

Eaton Lifesaver reusable hose fittings are designed to simplify the replacement of failed hose lines which have unusual, steel, end configurations or thread styles. The process involves removing the old tube configuration, silver brazing it to an unused lifesaver nipple and assembling the fitting onto the hose in the usual manner. A few Lifesaver fittings, some bulk hose, the appropriate hand tools and accessories plus basic silver brazing equipment are all that is necessary to make up hose assemblies anywhere. Be sure to follow all applicable safety procedures when making Lifesaver fittings.

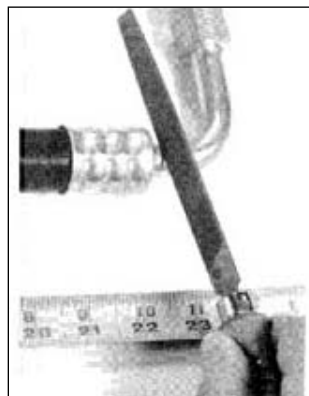

Step 1: Measuring

Measure and record the length of the old assembly. For elbow assemblies, scribe a very light mark 5/16" or more from the existing hose socket. The distance from the scribe mark to the end of the other fitting should be recorded as the fabrication length. In the case of double elbows, make the scribe marks in line with one another so that you can duplicate the phase angle later on. Record the distance between the two scribe marks as the fabrication length.

Step 2: Cutting

Using a hacksaw or tubing cutter, cut the tube at the juncture of the tube and the hose socket. It is important to cut the tube so there is at least a 1/4" length of straight, unbent tubing in order for it to properly enter into the counterbore of the Lifesaver nipple.



Step 3: Preparing the tube for brazing

Avoid touching the tube — oily or greasy surfaces tend to repel the flux and silver material leaving voids and inclusions. Clean the tube thoroughly using a residue-free degreasing agent or hot caustic soda.

Using a flat file, remove the burrs on the outside of the tube and use a rat tail file to remove the burrs on the inside.

Polish the end of the tube on the outside with an emery cloth to remove the plating down to the base metal. It is important to remove oil and grease first because abrasives tend to scrub the oil into the surface and/or impregnate it with a fine abrasive powder, resulting in further contamination. Remember, attempting to braze contaminated or improperly cleaned surfaces will generally result in an unsatisfactory joint!

Continued on next page.

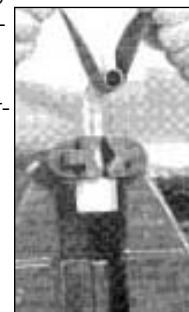

Step 4: Preparing the Lifesaver fitting for brazing

Clean the nipple and tube end thoroughly. Place the tube into the counterbore (it should fit freely into it). Measure the diameter of the counterbore to determine the braze ring size needed. At this point, you have the option of selecting a ready-made Eaton braze ring or making a ring for the application from bulk silver braze wire.

For quick, easy assembly, Eaton offers the following size range of FF9075 braze rings:

PART NUMBER	TUBE SIZE O.D.	
	mm	in.
FF9075-19	6,4	.25
FF9075-06	9,7	.38
FF9075-74	12,7	.50
FF9075-08	16,0	.63
FF9075-09	19,1	.75
FF9075-86	25,4	1.00
FF9075-87	31,8	1.25
FF9075-88	38,1	1.50

To assemble, simply place the appropriate size Eaton FF9075 braze ring into the counterbore of the Lifesaver nipple.

To make the braze ring, multiply the diameter of the counterbore by 3 to determine the length of silver wire needed. For example, if the counterbore diameter measures $\frac{3}{4}$ of an inch, a $2\frac{1}{4}$ - inch length of wire would be needed ($\frac{3}{4} \times 3 = \frac{9}{4}$ or $2\frac{1}{4}$). Now cut off a piece of silver wire just short of $2\frac{1}{4}$ inches, so it is about $2\frac{3}{16}$ inches long. Using needle nose pliers, form the wire into a ring and, after wiping it off, place the ring into the counterbore of the Lifesaver nipple.



Step 5: Fluxing

Cover the counterbore, ring, outer hex and threads of the Lifesaver nipple and the outside of the tube with water soluble flux.



Step 6: Brazing

Place the tube assembly into a vise. Place the nipple with its braze ring over the tube. Light the brazing torch and adjust the flame so that the base is blue with orange "feather-like flicks" at the end. Try to heat both the nipple and the tube uniformly so they both reach the brazing temperature at the same time. Don't overheat the thin section. As the temperature increases, the flux will undergo several changes:

- At 212°F the water boils off.
- At 600°F the flux becomes white and puffy and starts to "work" (snow balling).
- At 800°F it lays against the surface and has a milky appearance.
- At 1100°F it is completely clear and active and has the appearance of water. At this point, a bright metal surface will be apparent underneath.
- The silver wire melts at 1125°F and flows at 1145°F.

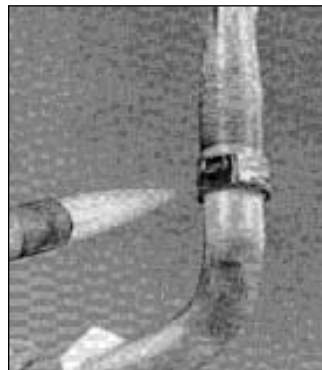

! CAUTION

Never heat the parts to a bright red color.

When the silver alloy melts, the flux will draw it throughout the joint and a small fillet of silver alloy will appear around the tube. When this happens, the braze is completed. Remove the heat source and allow the fitting to cool for five to ten seconds. Using pliers, place the fitting into water until it is completely cool.

! CAUTION

Steam may be directed through the fitting ends. To prevent burns, handle the fitting carefully! Hot water will facilitate flux removal.

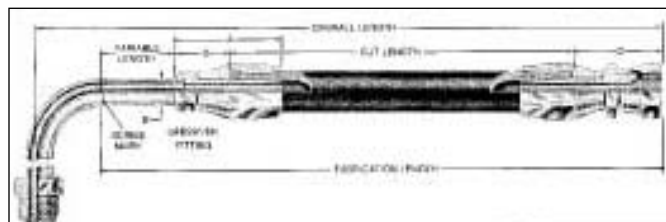

Step 7: Removing flux

It is necessary to remove residual flux from the area since it is corrosive and presents an unclean appearance and condition. Simply rub the surface using hot water and a wire brush. The water should be at least 120°F or hotter to be truly effective inside and out.

Step 8: Hose assembly

To determine the required amount of new hose, measure the distance from the scribe mark on the tube (refer to Step 1) to the shoulder hex of the Lifesaver nipple. Add this measurement to the Lifesaver "D" dimension found in the "Fittings" section of the Eaton Hose & Reusable Fittings Catalog. For each Lifesaver fitting, subtract this sum from the fabrication length previously recorded. When using Eaton fittings other than the Lifesaver type, subtract the appropriate "D" dimension found in the catalog. Cut the hose to this length and install both fittings.

Align the scribe marks to establish the phase angle. Spray paint the brazed joints to prevent rusting.

Assembly Instructions ORS-TF (Wedge Type) Tube Fittings

1. Measure the length of the tube assembly from the flat face of the ORS adapter in one port to the face of the ORS adapter in the opposite port. The length of the tube should then be adjusted to account for the shoulder thickness of the sleeve.

It is imperative that the routing leave a length of unbent tubing to fully enter the ORS fitting. This straight length must be free from surface defects, thin-out distortion, and ovality.

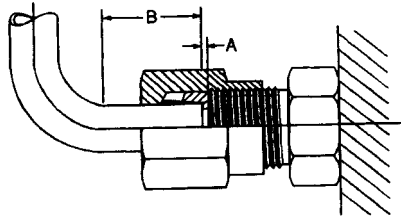

SIZE	TUBE O.D.	SLEEVE SHOULDER THICKNESS "A"		STRAIGHT TUBING REQUIRED "B"	
		mm	in.	mm	in.
-04	.25 (1/4)	1,8	.07	19,8	0.78
-06	.38 (3/8)	2,0	.08	22,3	0.88
-08	.50 (1/2)	2,3	.09	25,4	1.00
-10	.63 (5/8)	2,3	.09	26,9	1.06
-12	.75 (3/4)	2,3	.09	30,2	1.19
-16	1.00 (1)	2,3	.09	31,7	1.25
-20	1.25 (1 1/4)	2,3	.09	33,3	1.31
-24	1.50 (1 1/2)	2,3	.09	35,0	1.38

2. Inspect the tubing to insure that no scratches, gouges, burrs or other surface defects are present. Cut the measured tubing squarely ($\pm 1^\circ$). A tubing cutter is the best tool for this, but a hacksaw or abrasive wheel can be used. Use only SAEJ356, SAEJ524, SAEJ525, or SAEJ526 tubing with a hardness not to exceed Rockwell B65.



3. Deburr the tube ends with a deburring tool or fine cut file. After deburring, be sure to remove all contaminants and dirt from the interior and exterior of the tube.



4. Inspect ORS adapter and ORS-TF components for damage. Assure sealing surfaces are free from all surface gouges, scratches, dirt and contaminants. Inspect o-ring to insure that it is properly seated in the groove and is free from damage. Apply a thin film of compatible lubricant to the o-ring prior to installation.



5. Place a nut, ferrule and sleeve onto tubing, assuring that the identification groove of the ferrule is toward the nut. Assemble the nut to the adapter until "hand-tight" with the tubing fully inserted into the fitting until bottomed out. Mark the nut in relation with the adapter and tighten $1\frac{1}{2}$ turns with wrench. The ORS-TF sleeve cannot be used to preset multiple tube assemblies. It may be used once for presetting.

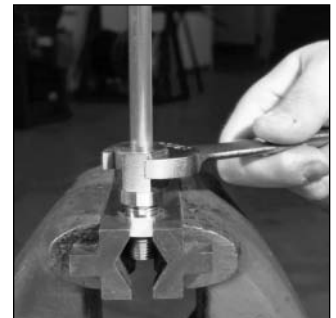

6. The ORS-TF tube assemblies are designed for reuse and can be reinstalled by tightening nut until a sharp increase in resistance is felt (approximately $\frac{1}{4}$ turn beyond "hand-tight").

8. If connections must be temporarily disassembled, use a threaded plug to contain the ORS-TF components and keep contaminants and dirt from entering the system.

7. WARNING

Tubing must be fully inserted into the fitting and the nut tightened as specified above to ensure performance and to prevent leakage and potential fitting blow-off. Excessive tightening of the nut beyond the recommended level may affect performance.

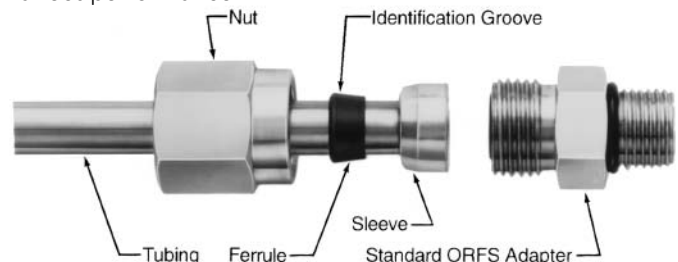

Brazing Instructions ORS-Braze Type Tube Fittings

Tube Preparation

1. Establish the required length of tubing. Allow for insertion depth in the ORS-Braze Type shoulder by adding the proper length of straight unbent tubing to enter into the shoulder counterbore. The counterbore depth is dependent upon the ORS-Braze Type shoulder size.



ORS-BRAZE TYPE SHOULDER SIZE	DEPTH OF COUNTERBORE	
	mm	in.
-04	6,3	.25
-06	6,3	.25
-08	9,6	.38
-10	9,6	.38
-12	9,6	.38
-16	12,7	.50
-20	12,7	.50
-24	12,7	.50

2. Cut the tubing squarely ($\pm 1^\circ$) to the proper length. A tubing cutter is the best tool for this, but a hacksaw or an abrasive wheel can be used.

3. Lightly deburr both I.D. and O.D. of tube.



Prepare the Tube

4. Clean the end of the tube thoroughly using a liquid solvent* such as denatured alcohol, alkaline cleaner or equivalent.

Avoid touching it because oily or greasy surfaces tend to repel the flux and silver material leaving voids and inclusions.

**CAUTION: Follow solvent manufacturer's recommendations for proper use. Follow approved procedures for disposal.*

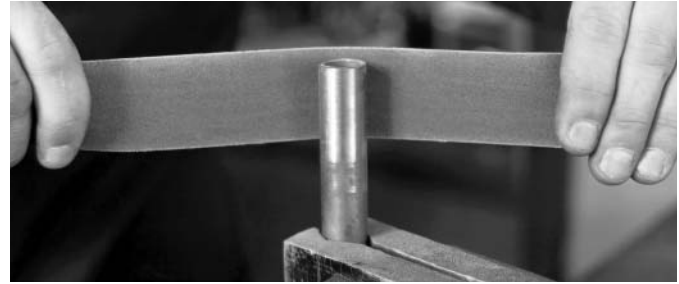

5. Polish tube end to bare metal using silicon carbide emery cloth. It is important to remove all oil and grease first because abrasives tend to scrub the oil into the surface and/or impregnate it with a fine

abrasive powder resulting in further contamination. Clean the tube end to remove the grit produced by the emery operation. Use either a clean solvent rinse or a clean, oil free soft cloth.

Prepare the Shoulder

6. Degrease the shoulder thoroughly. Inspect for presence of rust. If rust is present, follow the steps detailed previously to emery the counterbore.



Prepare Braze Rings

7. Degrease rings thoroughly. Preformed silver braze rings are available from Eaton. The preformed rings (Part Number FF9075-Size) will save you time and simplify your brazing even more.



If site-made rings are used, cut off a piece of silver wire* just short of three times the counterbore's diameter. For example, if the counterbore measured $\frac{3}{4}$ " you would cut $2\frac{1}{16}$ " of wire ($\frac{3}{4}$ " \times $2\pi r = 2\frac{1}{4}$ "). Use needle-nose pliers to shape the silver wire into a ring.

**If bulk wire is used it must contain a minimum of 45% silver content.*



Silver Braze Ring

PART NUMBER	TUBE SIZE O.D.	
	mm	in.
FF9075-19	6,4	.25
FF9075-06	9,7	.38
FF9075-74	12,7	.50
FF9075-08	16,0	.63
FF9075-09	19,1	.75
FF9075-86	25,4	1.00
FF9075-87	31,8	1.25
FF9075-88	38,1	1.50

Trial Assembly

8. Fit the shoulder onto the tube; it should fit freely for the full counterbore depth. Eaton recommends minimal diametrical clearance. Do not touch or contaminate mating surfaces.

Fluxing and Assembly



9. Clamp the tube snugly in a vise. Properly slip ORS-Braze Type nut (FC2326-SIZE-186) over the tube. The flux (high temperature 700°F to 1800°F is recommended) should be applied to all components and adjacent areas. This will minimize the heat scale formed, act as a temperature

10. Lightly flux ORS-Braze Type shoulder (FC1229-SIZE) counterbore, install clean braze ring to bottom of counterbore, reflux counterbore.

11. Slip shoulder onto tube squarely and so that braze ring is snug between the tube and counterbore lip.

12. Flux outside surfaces of shoulder.



indicator, and promote proper alloy flow during the brazing process.



14. Allow braze alloy to solidify completely before quenching. Cool the assembly in hot water (+180°F preferred) to help facilitate flux removal. Readily available flux removers can be added to the water. It is necessary to remove the flux residue because it is corrosive.



Braze Inspection

15. Inspect braze for a fillet all the way around the tube. Inspect the shoulder sealing surface. There should be no alloy overrun or alloy build-up on the sealing surface. An accumulation of braze alloy on the sealing surface or a void in the fillet is unacceptable and the shoulder should be replaced.



Brazing the Assembly



13. To properly braze the application of heat should bring both the tube and shoulder up to brazing temperature uniformly. Therefore, most of the heat should be directed to the shoulder and not the tube. The flux may be used as a guide:

- A. At +212°F the water boils off.
- B. At +600°F to +700°F the flux becomes puffy and starts to "work" (bubbles).
- C. At +800°F it lays against the surface and has a translucent appearance.
- D. At +1100°F it has the appearance of dark clear water.

16. It is recommended to proof test the assembly in an enclosed chamber. Proof test pressure should be twice the system's operating pressure but should not exceed twice the recommended operating pressure of the tube or end connections.

NOTE: The preceding procedure is recommended only. No guarantee or warranty is implied.



E. At +1125°F the silver braze ring melts and flows at +1145°F. At this point the shoulder should drop onto the tube a distance equal to the diameter of the braze ring, which is not melted and filling in the area between the counterbore and tube O.D. There should be visible braze material at both ends of the shoulder.

The braze joint area needs to be heated uniformly not just the O.D. surface. At brazing temperature the components will have a dark red to medium cherry red appearance. Do not overheat the parts as to char the flux. Remove the heat after the alloy has melted and pulled through the joint. Settle the shoulder onto the tube to insure proper insertion.

NOTE: The heating source should be varied. When using a flame, the fuel mixture should be adjusted so that the base of the flame is blue and there are also orange featherlike licks at the end of the flame.



SPECIALTY & TRUCK HOSE

LOW & MEDIUM PRESSURE HOSE

HIGH PRESSURE HOSE

HOSE FITTINGS

ADAPTERS & TUBE FITTINGS

ACCESSORIES & ASSEMBLY INSTRUCTIONS

HOSE ASSEMBLY EQUIPMENT

APPENDICES

Assembly Instructions for ORS Tube Fittings, Pipe Threads and SAE 37° (JIC) Flared Tube Fittings

Assembly Instruction for ORS Tube Fittings

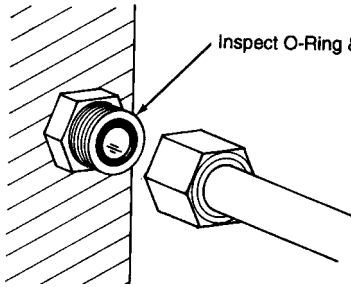

1. Inspect sealing surfaces and O-Ring groove for damage or foreign material. Check the O-Ring to insure that it is properly seated in the O-Ring groove.

3. Align the ORS Tube Fitting to the flat sealing connections and tighten the nut by hand. The nut should tighten easily by hand if properly aligned.

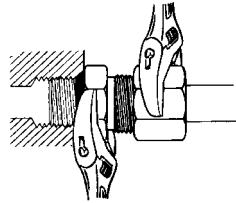

4. Complete the assembly by wrench tightening the nut to the recommended torque value on page 286.

Assembly Instructions for Pipe Threads

1. Assemble connection hand tight.
2. Mark male and female.
3. Rotate male; 1½ turns if using thread sealant. 2 turns if not using thread sealant.

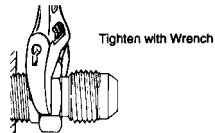
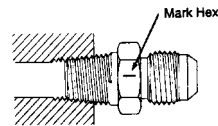
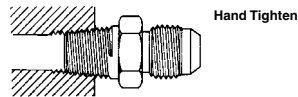
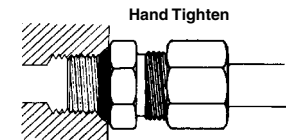
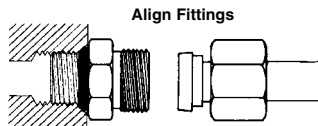

Assembly Instructions for Standard SAE 37° Flare Type Tube Fitting

Use SAE J524 or SAE J525 tubing for best bending and flaring results.

1. Cut the tubing with a tube cutter. If a fine tooth hacksaw is used, make sure cut-off is square; remove burrs with deburring tool, emery paper or fine file. Clean all dirt and grit from the I.D. and O.D. of the tube.
2. Place the nut and then the sleeve onto tube.
3. Flare the tube end with a flaring tool to provide a 37° flare. Check the flare for correct diameter, excessive thin out and burrs or cracks.

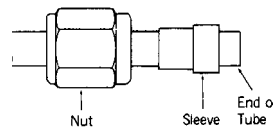

4. Lubricate all mating surfaces of nut, ferrule and body with a heavy lubricant such as Aeroquip 222070 Lube.
5. Assemble the nut and sleeve to body. Turn the nut hand tight then wrench tighten for a leakproof joint. See page 378, torque values, for assembly using a torque wrench.

The Eaton standard 37° flare fitting is easy to disassemble and may be reassembled repeatedly.

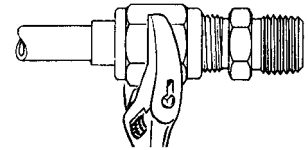

Assembly Instructions for Versil-Flare Tube Fittings

Cutting

To insure a leak-proof joint, the tubing should be cut square ($\pm 1^\circ$). A tube cutter is preferred, but a hacksaw or abrasive wheel can be used.



Out of Square Cut



Square Cut

Deburring

All cut tubes should be deburred. However, deburring is even more important if the tubing was cut with a hacksaw or abrasive wheel. Remove any burrs, both internally and externally, with a deburring tool, emery paper or fine file. Clean the tube before assembly. Clean all dirt and grit from the I.D. and O.D. of the tube.

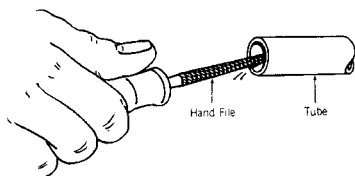

Assembly Instructions for Versil-Flare Tube Fitting

Tube cut-off

1. Tube should be cut to fit tight against the face of standard SAE 37° flare body.

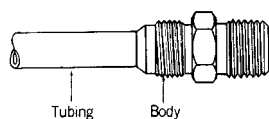

Initial assembly

1. Deburr the end internally and externally. Clean all dirt and grit from I.D. and O.D.
2. Slide the nut and then the ferrule into the tube. Make sure the tapered end of ferrule points toward the nut.

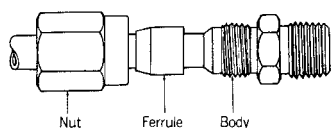

3. Lubricate all mating surfaces of nut, ferrule and body with a heavy lubricant such as Aeroquip 222070 Lube.
4. Place end of tube against standard SAE 37° flare body.

5. Slide the ferrule and nut against body and tighten the nut onto the body "Hand Tight." Mark the nut in relation to the body for location.

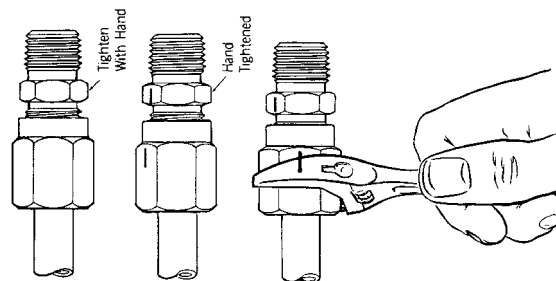

6. Hold tube against body and tighten nut a total of $1\frac{1}{4}$ turns on -3 through -10 and $1\frac{1}{2}$ turns -12 through -32.

Reassembly

1. Slide nut against the body and tighten to "Hand Tight." Mark the nut for location.
2. Tighten nut a minimum of one "Hex" flat. The Versil-Flare flareless tube fitting is designed for a maximum of 10 reassemblies.

Assembly Instructions – Adjustable O-Ring Boss

On SAE, and
BSPP threads without check washer

On BSPP
threads with check washer

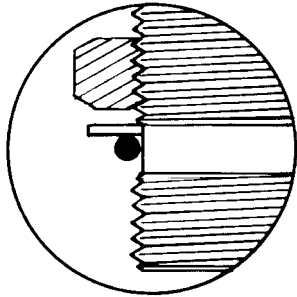
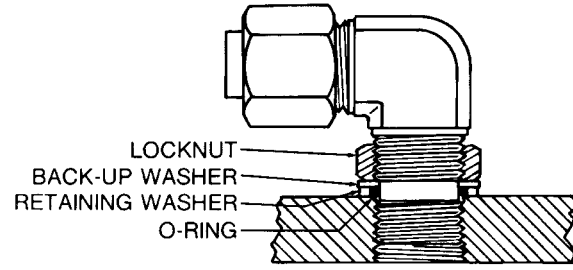
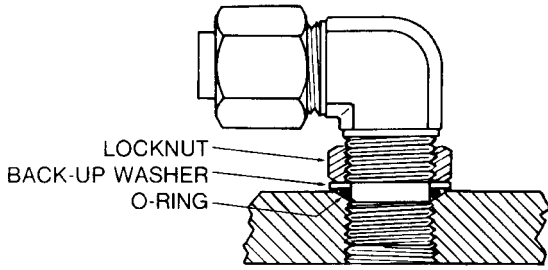

The o-ring and back-up washer should be in the proper position on non-threaded section nearest to locknut. Lubrication of the o-ring is recommended.

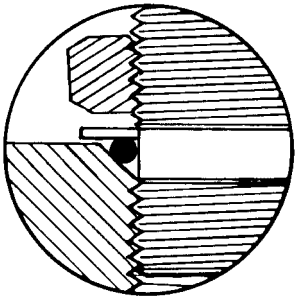
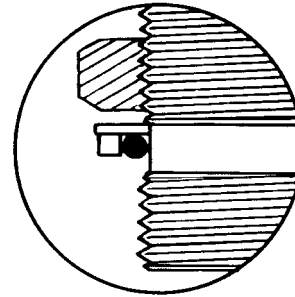

Tighten the fitting by hand into the straight threaded boss until back-up washer contacts face of boss (left) or check washer when thread is BSPP (right.)

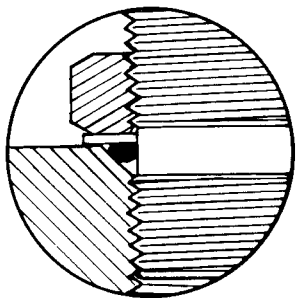
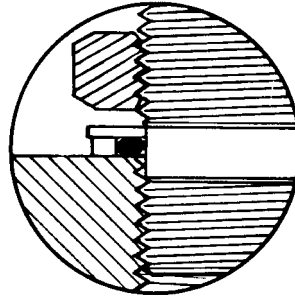

In order to position the fitting, unscrew up to one full turn then hold fitting in desired position and tighten locknut so that the back-up washer contacts face of boss and forces the o-ring within boss cavity. With BSPP threads use same procedure. The difference between the two thread types exist in the check washer being in contact with face of boss (right inset). Assemble to the respective assembly torque specified on page 378.

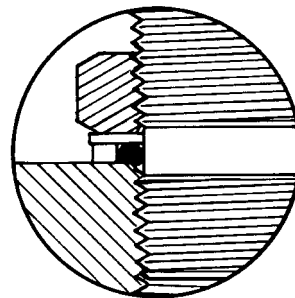

SPECIALTY & TRUCK HOSE
LOW & MEDIUM PRESSURE HOSE
HIGH PRESSURE HOSE
HOSE FITTINGS
ADAPTERS & TUBE FITTINGS
ACCESSORIES & ASSEMBLY INSTRUCTIONS
HOSE ASSEMBLY EQUIPMENT
APPENDICES

Terms

- *Skive*—Removal of the cover material exposing the reinforcement prior to fitting assembly.
- *Dash Size*—The hose or fitting size expressed in $\frac{1}{16}$ of an inch. The numerator of a fraction whose denominator is 16. Example: -8 or -08 is $\frac{8}{16} = \frac{1}{2}$."
- *Nipple*—The part of a hose fitting that goes into the hose tube.
- *Socket*—The part of a hose fitting that goes over the hose cover or reinforcement.
- *Mandrel*—A round, properly sized, steel bar used for support during assembly of the fitting or skiving the hose cover.
- *Annular Rings*—A series of concentric rings inside the socket.

Reusable fitting tips to remember for easy assembly

- Part numbers and dash sizes are indicated on fitting sockets.
- It is essential the fitting be mated with a compatible hose style with the same dash size. See Socket Data pages 63-65.
- Reusable fittings that have a notch in the socket serve as a reference for the cover skiving length.
- Familiarize yourself with the assembly instructions before you start to make an assembly.
- For hoses that require skiving, be sure to skive the hose to the proper length and **down to the wire reinforcement**.
- Use Aeroquip 222070 hose assembly lube liberally on both the inside of the hose and on the fitting nipple. (Check for compatibility.)
- Always cut hose square by using a sharp instrument (hacksaw or cutoff wheel).
- For volume production of hose assemblies, use Eaton Assembly Equipment.

Cutting the hose

1. To determine the "J" length (cut length of hose) from "OA" (overall length) deduct "D" dimensions of both end fittings. Consult fitting information pages for "D" dimensions. For hose assemblies with SOCKETLESS fittings, add $\frac{1}{2}$ " to "J" length. **Tip: If the old Aeroquip assembly was the right length, simply remove the hose fittings and measure the hose.**
2. Cut the hose square. Use a cut-off wheel or fine-tooth hacksaw.
3. Clean the hose bore. Blow out shavings with shop air, blow a foam projectile through the hose using the JetCleaner System (see page 296) or flush with a solvent compatible with the hose construction.



CAUTION
Follow proper safety procedures.

Phase angle (offset)

When making double elbow assemblies, the following steps should be followed to obtain the desired angle between elbows. Tighten both elbows to maximum allowable gap between socket and nipple hex. Start to position for relative angle between elbows. Finish assembly by adjusting both elbows. Backing off to get desired angle should be avoided.

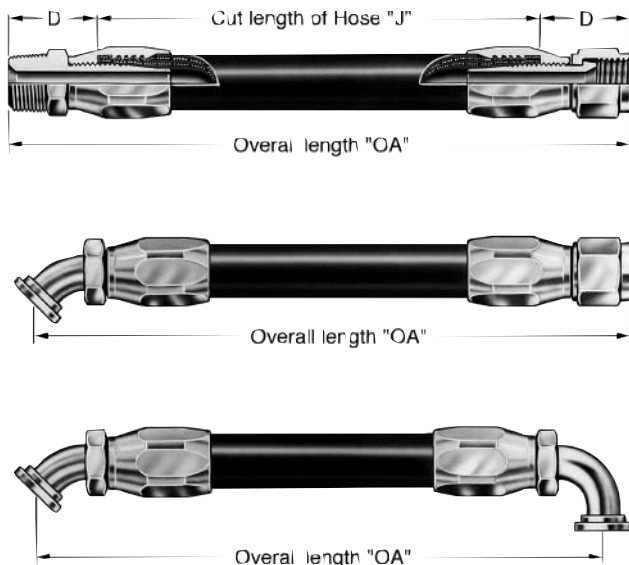
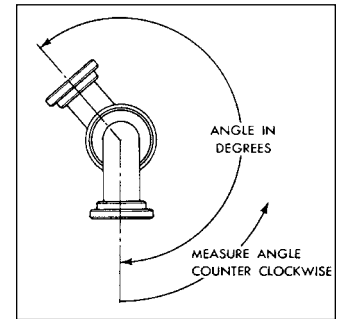

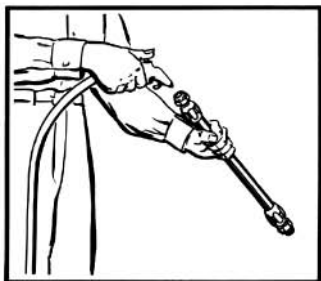

Clean



Inspect

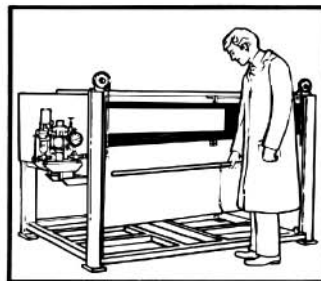

Proof test - hydrostatic

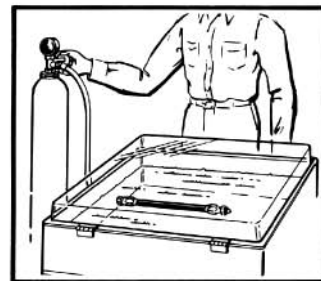

Proof test - pneumatic

Maintenance

Hose assemblies in operation should be inspected frequently for leakage, kinking, abrasion, corrosion or any other signs of wear or damage. Worn or damaged hose assemblies should be replaced immediately.

Clean

At minimum a hose assembly should be blown out with clean compressed air. Eaton recommends using the Jetcleaner Hose Cleaning System (See page 296 for details). Assemblies may be rinsed out with mineral spirits if the tube stock is compatible with oil, otherwise hot water at +150°F max. may be used. Consult Eaton for special cleaning equipment.

Inspect

Examine hose assembly internally for cut or bulged tube, obstructions, and cleanliness. For segment style fittings, be sure that the hose butts up against the nipple shoulder; band and retaining ring are properly set and tight, and segments are properly spaced. Check for proper gap between nut and socket or hex and socket. Nuts should swivel freely. Cap the ends of the hose with plastic covers to keep clean.

Proof test - hydrostatic

The hose assembly should be hydrostatically tested at twice the recommended working pressure of the hose.

Test pressure should be held for not more than one minute and not less than 30 seconds. When test pressure is reached, visually inspect hose assembly for: a) Any leaks or signs of weakness. b) Any movement of the hose fitting in relation to the hose. Any of these defects are cause for rejection.

Caution: Testing should be conducted in approved test stands with adequate guards to protect the operator.

(See Assembly Equipment Section for Eaton Proof Test Stands.)

Proof test - pneumatic

Hose assemblies intended for gas or air service should be tested with air or nitrogen at 100 psi with the assembly immersed in water. Random bubbles may appear over the hose and fitting area when assembly is first pressurized. This should not be construed as a defect. However, if the bubbles persist in forming at a steady rate at any particular point on the hose, the assembly should be rejected.

Caution: Testing should be conducted in approved test stands with adequate guards to protect the operator.

Storage and handling

Hose should be stored in a dark, dry atmosphere away from electrical equipment, and the temperature should not exceed +90°F. Storage in the original shipping container is preferred.

Standard (mandrelless) reusable fittings with single wire braid, multiple textile braid, hydraulic and LPG hose.

FC234, FC300, FC321, FC350, FC355, 302A, 303, 1503, 2580, 2651

(for fittings requiring mandrel, see page 324).

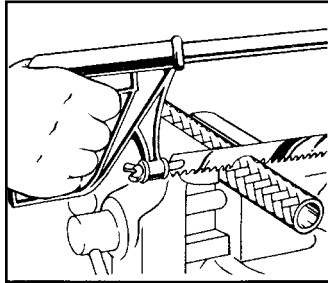

Step 1

Cut hose square with fine-tooth hacksaw or cut-off wheel.

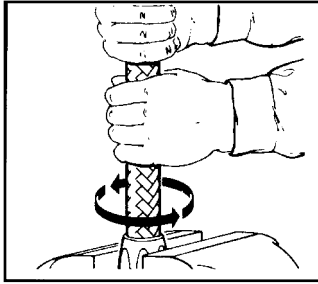

Step 2

Put socket in vise.

Screw hose counterclockwise into socket until it bottoms.

Back off 1/4 turn.

When assembling long lengths of hose, it may be preferred to put hose in vise just tight enough to prevent from turning, and screw socket into the hose counterclockwise until it bottoms.

Back off 1/4 turn.

Back off FC300, FC350 and FC355 1/4 to 1/2 turn.

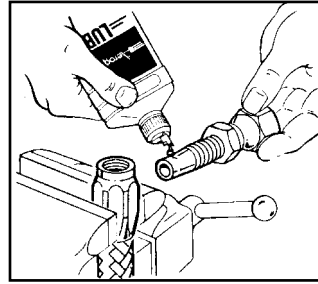

Step 3

Lubricate nipple and threads **LIBERALLY**. Use heavy oil or Aeroquip 222070 hose assembly lube.

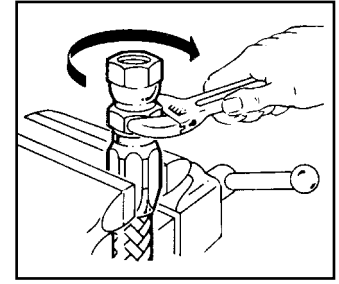

Step 4

Screw nipple clockwise into socket and hose. Leave 1/32" to 1/16" clearance between nipple hex and socket.

Recommendations for cleaning, inspection and testing are summarized on page 318. Disassemble in reverse order.

SOCKETLESS Fittings with textile braid low pressure hose

FC332, FC647, 2556, 2565, 2575

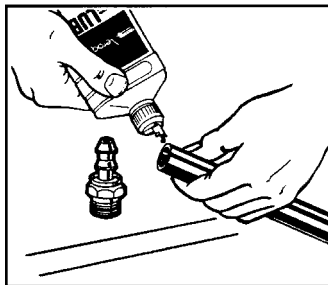

To Assemble

Step 1

Cut hose to required length with a sharp knife. Oil inside of hose and outside of nipple **LIBERALLY**.

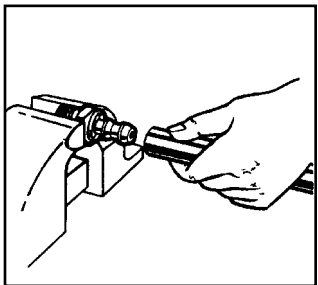

Step 2

Push hose on fitting until hose end bottoms underneath protective cap as shown. For quantity production use a **SOCKETLESS Fitting assembly machine**. Recommendations for cleaning, inspection and testing are summarized on page 318.

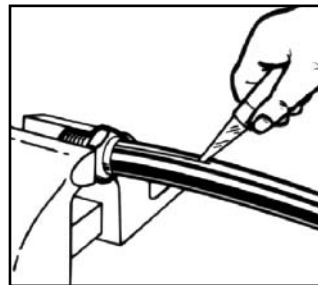

To Disassemble

Step 1

Slit hose lengthwise from protective cap to end of nipple.

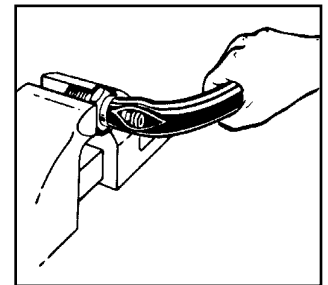

Step 2

Bend hose, then snap hose off with a quick tug.

**Standard reusable fittings with Hi-Pac
and two wire braid hose FC195, FC310,
FC510, 2766, 2781**

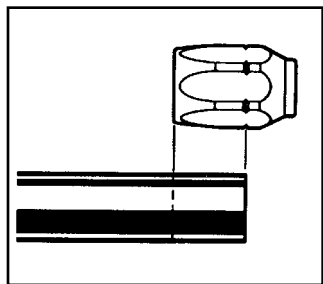

Step 1

Cut hose to length required using a fine-tooth hacksaw or cut-off wheel. Clean hose bore.

Hose must be stripped of its rubber cover before inserting in socket. Locate skiving point by putting hose end next to socket as shown. Measure from hose end of socket to notch on socket.

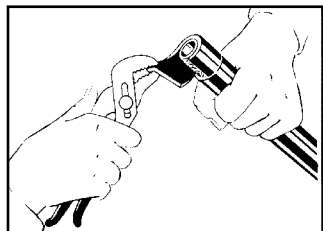

Step 1A

Skive Hose:

By Hand: Cut rubber cover around down to wire reinforcement. Slit lengthwise. Raise flap and pull off with pliers. Clean excess rubber off wire reinforcement with wire brush or soft wire wheel. Do not fray or flare wire reinforcement when brushing.

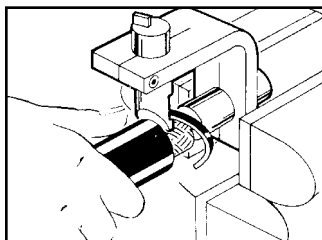

Skive Tool: Use the correct size FT1229 hose cover skiving tool. Mount the tool in a vise. Push the hose over the mandrel. Rotate the hose clockwise until it bottoms or secure hose in a vise and attach FT1279 auger to the skive tool. Insert mandrel into the hose and rotate clockwise until it bottoms.

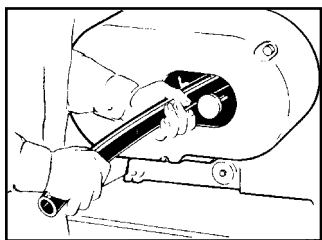

Machine: Use the S1102 cut-off and skiving machine. Consult the owners manual. Select the correct mandrel. Turn on the machine. Put the hose over the mandrel and rotate.

Note: when skiving, remove the rubber cover until the wire reinforcement is exposed around the circumference of the hose.

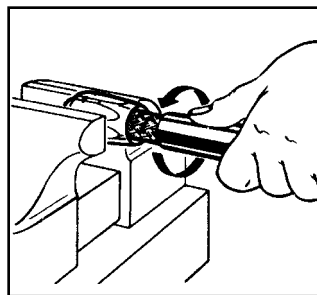

Step 2

Put socket in vise.

Screw hose into socket counterclockwise until it bottoms.

When assembling long lengths of hose, it may be preferred to put hose in vise just tight enough to prevent from turning, and screw socket onto the hose counterclockwise until it bottoms.

NOTE: Sockets for hose fittings in the -16, -24 and -32 sizes are furnished with internal annular grooves in place of helical grooves (all FC310 and FC510 hose sockets are annular grooved). Install socket by pushing hose into socket with a back and forth rocking and twisting motion until hose bottoms on shoulder of socket.

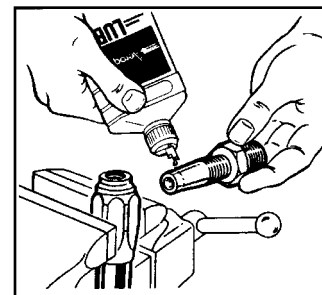

Step 3

Lubricate nipple threads and inside of hose liberally. Use heavy oil or Aeroquip 222070 hose assembly lube.

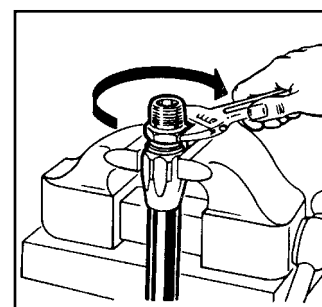

Step 4

Screw nipple clockwise into socket and hose.

Leave 1/32" to 1/16" clearance between nipple hex and socket.

Recommendations for cleaning, inspection and testing are summarized on page 318. Disassemble in reverse order.

Standard reusable fittings with four spiral wire hose

FC136, FC324, GH493, FC736

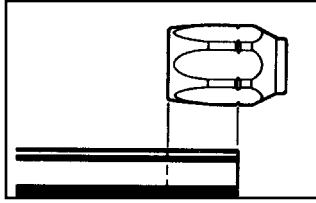

Step 1

Cut hose to length required using a fine-tooth hacksaw or cut-off wheel. Clean hose bore.

Hose must be stripped of its rubber cover before inserting into socket. Locate skiving point by putting hose end next to socket as shown. Measure from hose end of socket to notch on socket.

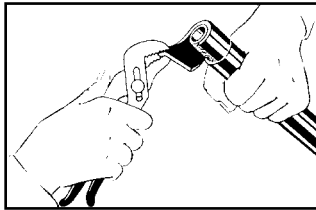

Step 1A

Skive Hose

By Hand: Cut rubber cover around down to wire reinforcement with a knife. Slit lengthwise. Raise flap and pull off with pliers. Clean excess rubber off wire reinforcement with wire brush or soft wire wheel. Do not fray or flare wire reinforcement when brushing.

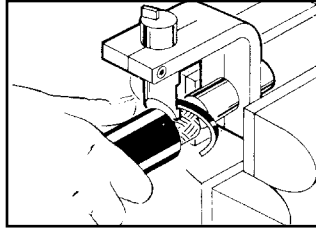

Skive Tool: Use the correct size Eaton FT1229 hose cover skiving tool. Mount the tool in a vise. Push the hose over the mandrel. Rotate the hose clockwise until it bottoms or secure hose in a vise and attach FT1279 auger to the skive tool. Insert mandrel into the hose and rotate clockwise

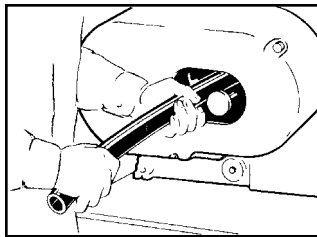

until it bottoms.

Machine: Use the Eaton S1102 cut-off and skiving machine. Consult the owners manual. Select the correct mandrel. Turn on the machine. Put the hose over the mandrel and rotate counterclockwise.

Note: when skiving, remove the rubber cover until the wire reinforcement is exposed around the circumference of the hose.

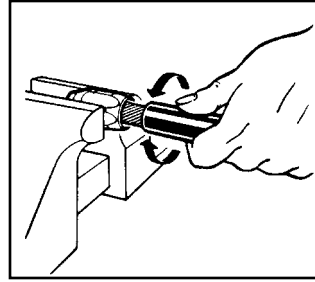

Step 2

Sockets for hose fittings are furnished with internal annular grooved design. Install socket by pushing hose into socket with a back and forth rocking and clockwise twisting motion until hose bottoms on shoulder of socket.

An alternate method is to insert the hose in a vise. Install socket by pushing onto the hose with a back and forth rocking and clockwise twisting motion until the hose bottoms on the shoulder of socket.

A rawhide hammer or similar tool may be used to tap the socket onto the hose but avoid damage to internal socket threads. Be sure not to damage hose cover or wire reinforcement.

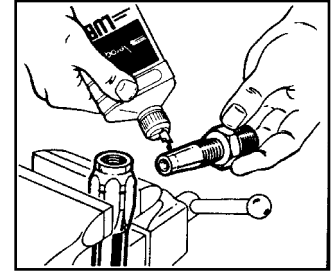

Step 3

Liberaly lubricate nipple threads and inside of hose. Use heavy weight oil or Aeroquip 222070 hose assembly lube.

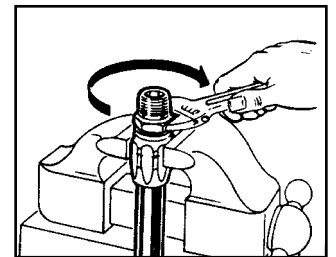

Step 4

Screw nipple clockwise into socket and hose. Leave a $\frac{1}{32}$ " to $\frac{1}{16}$ " clearance between nipple hex and socket.

Recommendations for cleaning, inspection and testing are summarized on page 318. Disassemble in reverse order.

Thru-the-cover style reusable fittings with hose

FC211, FC212, GH663, GH793

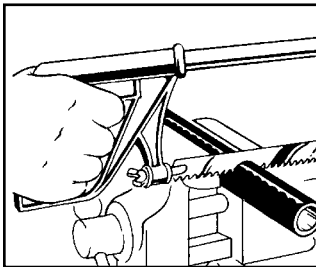

Step 1

Cut hose to length required using a fine tooth hacksaw or cut-off machine. Clean hose bore.

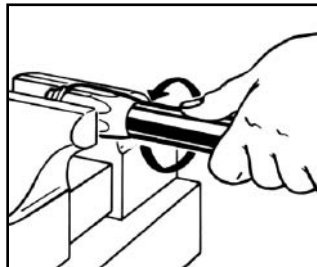

Step 2

Liberaly lubricate hose cover with Aeroquip 222070 hose assembly lube.

Place socket in vise and turn hose into socket counterclockwise until it bottoms.

When assembling long lengths of hose, it may be preferred to put hose in vise just tight enough to prevent from turning, and screw socket onto the hose counterclockwise until it bottoms.

Step 3

Liberaly lubricate nipple threads and inside of hose. Use heavy weight oil or Aeroquip 222070 hose assembly lube.

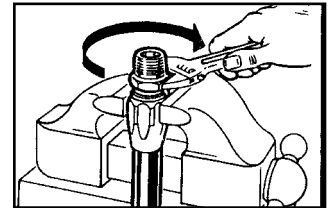

Step 4

Screw nipple clockwise into socket and hose. Leave $\frac{1}{32}$ " to $\frac{1}{16}$ " clearance between nipple hex and socket.

Recommendations for cleaning, inspection and testing are summarized on page 318. Disassemble in reverse order.

Standard (mandrelless) reusable fittings with engine, air brake and railroad air brake hose 1531, 1531A, 2550, 2554, 2570 (for fittings requiring mandrel, see page 324)

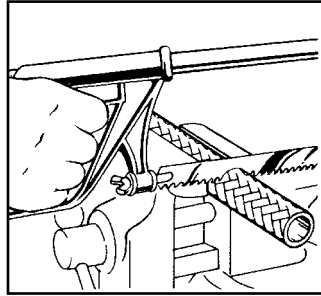

Step 1

Cut hose square to length required with fine-tooth hacksaw or cut-off wheel. Clean hose bore.

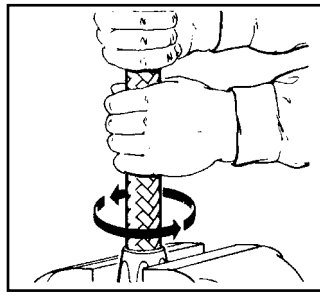

Step 2

Put socket in vise. Screw hose counterclockwise into socket until hose bottoms. Back off $\frac{1}{4}$ turn.

When assembling long lengths of hose, it may be preferred to put hose in vise just tight enough to prevent from turning, and screw socket into the hose counterclockwise until it bottoms. Back off $\frac{1}{4}$ turn.

NOTE: For 2550, 2554 and 2570 hose: Sockets for these hose fittings are furnished with internal annular grooved design. Install socket by pushing hose into socket with a back and forth rocking and twisting motion until hose bottoms on shoulder of socket. Back off $\frac{1}{4}$ turn.

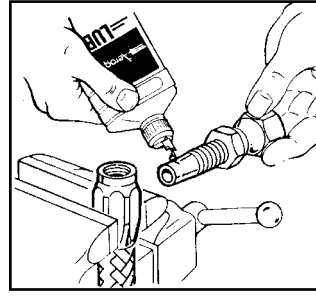

Step 3

Lubricate nipple threads and inside of hose LIBERALLY with Aeroquip 222070 hose assembly lube or heavy weight oil.

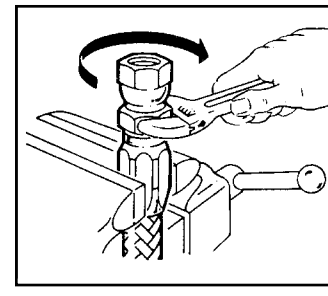

Step 4

Screw nipple clockwise into socket and hose. Leave a $\frac{1}{32}$ " to $\frac{1}{16}$ " clearance between nipple hex and socket.

Recommendations for cleaning, inspection and testing are summarized on page 318. Disassemble in reverse order.

"super gem"® Fittings with PTFE hose

FC465, 2807, 2808, FC807

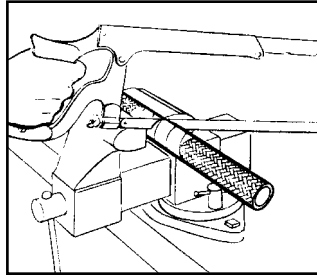

Step 1

Wrap hose with masking tape at cut-off point and cut square to length through taped area using a cut-off machine or fine-tooth hacksaw. Remove tape and trim any loose wires flush with tube stock. Any burrs on the bore of the tube stock should be removed with a knife. Clean the hose bore. Sometimes wire braid will tend to "neck down" on one end and flare out, on the opposite end. This is a characteristic of wire braid hose and can be used to an advantage in the assembly of the "super gem" sockets. Slip two sockets back to back over the "necked down" end of the hose.

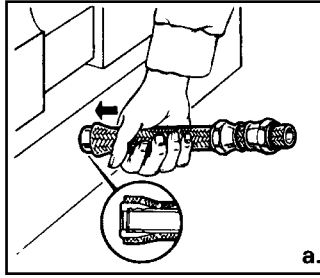

Step 2

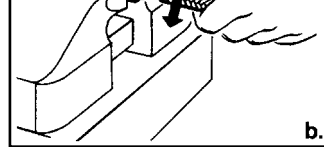

- a. Push the sleeve over the end of the tube and under the wire braid by hand. Complete positioning of the sleeve by pushing the hose end against a flat surface. Visually inspect to see that tube stock butts against the inside shoulder of the sleeve.
- b. Set the sleeve barbs into the PTFE tube by using assembly tool FT1038A or working the hose bore over the nipple into the end of the sleeve and tube. Assembly kit FT1081 is also available.

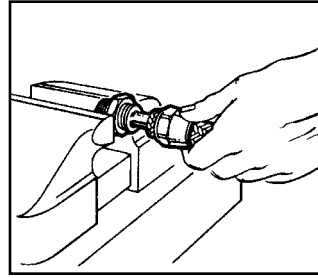

Step 3

Lubricate nipple and socket threads. For stainless steel fittings, use a molydisulfide base lubricant (e.g., Molykote* Type G), lubricants containing chloride are not recommended. Other material combinations use standard petroleum lubricants. Hold the nipple with hex in vise. Push hose over nipple with twisting motion until seated against nipple chamfer. Push socket forward and hand start threading of socket to nipple.

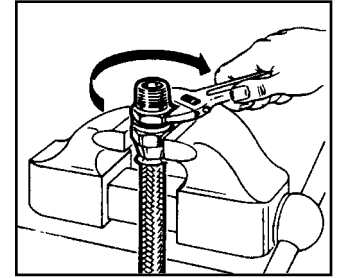

Step 4

Wrench tighten nipple hex until clearance with socket hex is $\frac{1}{32}$ " or less. Tighten further to align corners of nipple and socket hexes. Recommendations for cleaning, inspection and testing are summarized on page 318.

To disassemble: Unscrew and remove nipple; slide socket back on hose by tapping against flat surface; remove sleeve with pliers. New sleeves are recommended upon reuse of the fitting.

**Molykote Type G is a registered trademark of the Dow Corning Corporation.*

SPECIALTY &
TRUCK HOSE

LOW & MEDIUM
PRESSURE HOSE

HIGH PRESSURE HOSE

HOSE FITTINGS

ADAPTERS &
TUBE FITTINGS

ACCESSORIES &
ASSEMBLY INSTRUCTIONS

HOSE ASSEMBLY
EQUIPMENT

APPENDICES

Hose and Reusable Fittings

Mandrel Type Fittings—

Standard reusable fittings with single wire braid, multiple textile braid, hydraulic, LPG hose, engine and air brake hose
FC234, FC300, FC321, FC350, FC355, 302A, 303, 1503, 2580, 2651

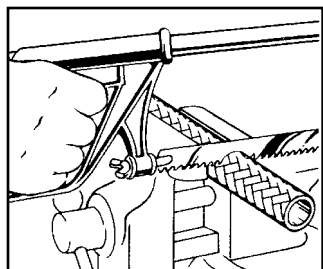

Step 1

Cut hose square with fine-tooth hacksaw or cut-off wheel. Clean hose bore.

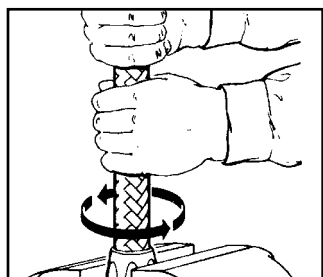

Step 2

Put socket in vise.

Screw hose counterclockwise into socket until it bottoms.

When assembling long lengths of hose, it may be preferred to put hose in vise just tight enough to prevent from turning, and screw socket onto the hose counterclockwise until it bottoms.

Back off 1/4 turn.

Back off FC300, FC350 and FC355 hose 1/4 to 1/2 turn.

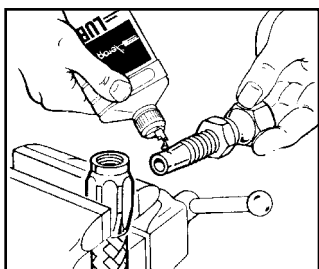

Step 3

MALE ENDS: Push assembly tool into nipple.

SWIVEL ENDS: Tighten nipple and nut on assembly tool.

Lubricate nipple, mandrel and inside of hose liberally. Use heavy oil or Aeroquip 222070 hose assembly lube.

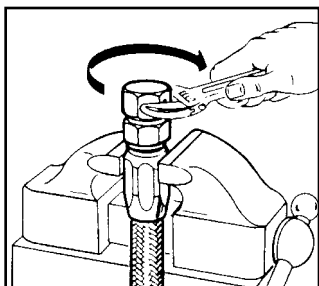

Step 4

MALE ENDS: Screw nipple clockwise into socket and hose. Leave a 1/32" to 1/16" clearance between nipple hex and socket.

SWIVEL ENDS: Screw nipple clockwise into socket and hose. Leave 1/32" to 1/16" clearance between nut and socket.

Recommendations for cleaning, inspection and testing are summarized on page 318. Disassemble in reverse order.

Nipple and clamp with suction hose

2661, FC619

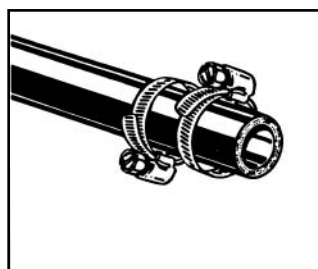

Step 1

Cut hose square to length required using a fine-tooth hacksaw or cut-off wheel. Clean hose bore. Slide band clamp over hose cover.

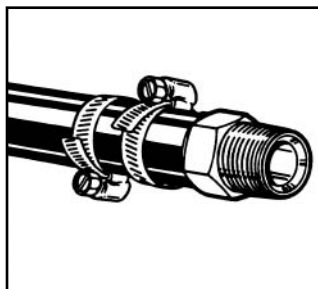

Step 2

Insert nipple into hose until hose end bottoms on nipple shoulder.

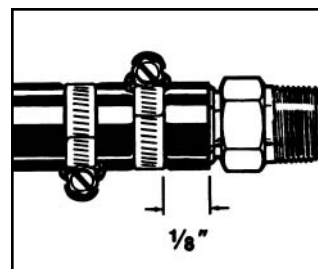

Step 3

Evenly space two band clamps from end of hose to end of nipple (see above). The band clamps should be tightened 180° from each other. Tighten clamps to 100 in-lbs. Recommendations for cleaning, inspection and testing are summarized on page 318.

Silicone hose FC252/FC352

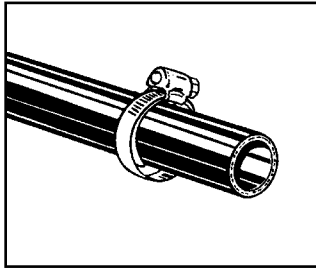

Step 1

Cut hose square to length required with a sharp knife. Slide extended hose clamp (FF9148) over hose cover.

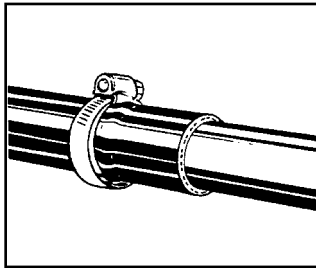

Step 2

Push hose over beaded tube.

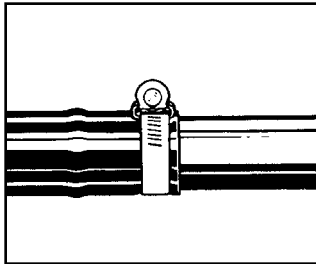

Step 3

Locate extended hose clamp (FF9148) near the end of hose and tighten the clamp.

Clamps: Extended hose clamps or clamps with a shoe are recommended for securing to formed and beaded male tube ends.

CAUTION: Do not use wire type clamps for securing silicone hose.

Note: Use of the FF9148 hose clamp will help prevent extrusion of the rubber cover through the clamp.

900705 Steel protec- tive coil sleeve

900564 Steel protec- tive coil spring

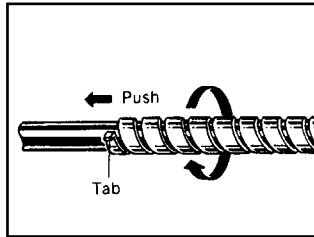

900705 sleeve

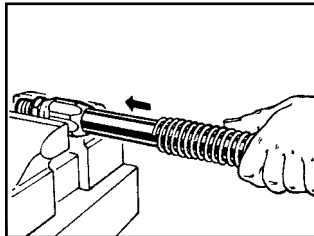

900564 spring

Step 1

Follow the appropriate assembly instructions through the assembly of one end fitting. Insert one end fitting in vise.

Step 2

Cut coil length. Coil should be cut to overall assembly length "OA" minus the sum of the overall length of each end fitting. ("A" dimension).

Step 3

3a) 900705 Steel Protective Coil Sleeve

The hose and the coil should be held straight. Taping or capping the hose end can prevent frayed wire ends from snagging on the coil. Bend one end to the coil outward to form a slight tab to assist grasping. (Cut off or bend back when installation is complete.) Hold the tab with the thumb of one hand while twisting the coil clockwise approximately one foot back from the coil tab. When the coil opens up sufficiently, slip the tab end to the coil over the hose. Move the coil onto the hose by pulling at the tab end while pushing with the other hand. Be careful not to exceed the resiliency of the coil by stretching it too far.

3b) 900564 Steel Protective Coil Spring

Slide coil over hose.

Step 4

Proceed with assembly of second end fitting.

900952 Plastic coil sleeve

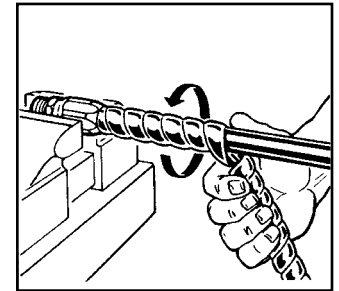

Step 1

Follow the appropriate hose assembly instructions through the assembly of both end fittings. Insert end fitting in vise.

Step 2

Cut coil length. Coil should be cut to overall assembly length "OA" minus the sum of the overall length of each end fitting. ("A" dimension).

Step 3

Wrap the coil on the hose.

Internal support coils

222005, 222022

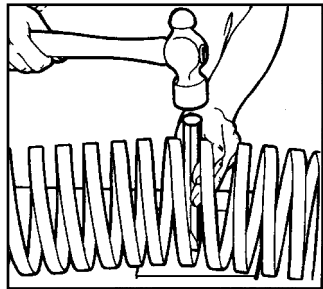

Step 1

Cut coil length. The coils should be cut to the hose length, minus the nipple intrusion. For any given hose assembly the support coil length equals the overall hose assembly length minus the sum of the overall lengths of each end fitting. ("A" dimensions.)

Small size of the coil can usually be cut with strap cutters or sheet metal shears. The larger sizes are best cut with a heavy sharp chisel or bolt cutter. With small sizes skip directly to Step 3.

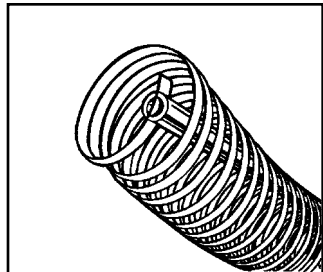

Step 2

Compress the coil (large sizes only). It is necessary to reduce the coil diameter slightly in order to insert it into the hose. The easiest approach is to use a length of pipe with a notch cut in one end. Clamp the plain end of the pipe in a vise, slide the coil over the pipe and insert the free end of the coil into the notched end of the pipe. Then clamp the coil and pipe firmly together. Twist the coil to compress it prior to installation into the hose.

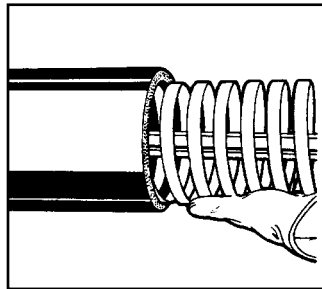

Step 3

Small sizes: The coil can be worked into the hose by hand without difficulty. Remove all burrs from the coil prior to insertion. This will prevent cutting of the hose tube. Position the coil midway between hose ends.

Large sizes: With the pipe still in position, as in Step 2, assemble the hose over the coil. With the coil fully centered in the hose, remove the pipe and clamp.

Firesleeve

624

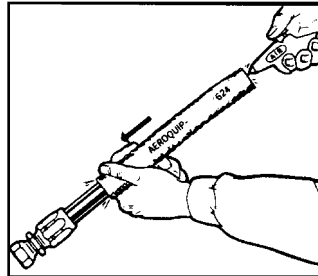

Step 1

Follow the appropriate hose assembly instructions through the assembly of one end fitting. Cut firesleeve to same length as hose; using Firesleeve End Dip (AE13702-003) dip ends of firesleeve to a depth of three quarters of an inch and allow to dry at room temperature.

Start firesleeve over cut end of hose. Note: If applying sleeve over PTFE or stripped cover assemblies, wrap exposed wire with tape. Grasp sleeve and slip over the hose assembly as illustrated.

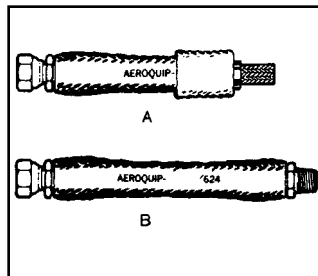

Step 2

Skin sleeve back from cut end of hose enough to allow assembly of second end fitting. (2A)

Then center sleeve so that it completely covers both sockets. (2B)

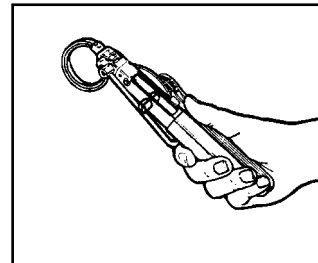

Step 3

Insert tail of band clamp into hand clamping tool.

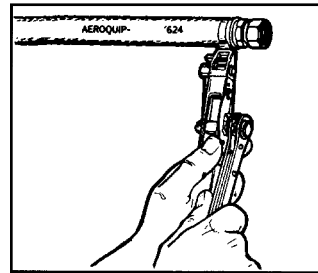

Step 4

Position band clamp over sleeve as shown and then draw tight with hand tool. Remove tool and cut free end of band clamp. Repeat on other end of assembly. To complete, bend protruding tail of clamp over clamp buckle. Also repair any scuffs or minor abrasions of firesleeve by brush application of End Dip AE13702-003.

ProCrimp® 1380



The ProCrimp 1380 crimp machine from Eaton crimps all your hose needs up to and including -20 SAE100R12 hose styles and the popular MatchMate Plus hose and fittings program (shown with optional die holder kit FT1380-2-4). The ProCrimp 1380 is electronically controlled to give fast, accurate crimps the first time and every time you need a hose assembly. The electronic keypad is easy to adjust, with up to 10 programmable crimp settings. For hose styles and sizes used less frequently simply enter the 3 digit code of that hose.

Ordering Instructions

- FT1380-115** 115V crimp machine 60 Hz
- FT1380-115-5** 2-Wire braid hose package FT1380-115 with the 5 die cages needed to crimp the 5 most popular GH793 or GH781 2-wire hose sizes: -4, -6, -8, -12 and -16
Die Cages
FT1380-200-M150
FT1380-200-M210
FT1380-200-M240
FT1380-200-M320
FT1380-275-M370
- FT1380-115-8** Braided and spiral hose package FT1380-115-5 with the 3 additional die cages — capable of crimping all MatchMate Plus hoses through -20
Die Cages
FT1380-200-M180
FT1380-200-M280
FT1380-275-M465
* Must also order FT1380-275-M420 to crimp GH194-20 and GH663-20
- FT1380-2-3** FT1330 to FT1380 Die Cage conversion kit — back plate, bolts and instructions necessary to convert an FT1330 die cage to an FT1380 die cage. Simply remove the FT1330 back plate and replace it with the new FT1380 back plate.
- FT1380-2-4** Optional die holder kit — Kit includes 4 die holder plates each of which will hold 2 die cages. Holes are pre-drilled on base of ProCrimp machine to accept these 4 plates.
- FT1380-4** Optional fitting backstop-kit includes backstop and $\frac{5}{32}$ " hex wrench. The backstop allows the 1380 to crimp PTFE hose and be utilized for a fitting locator to increase efficiency.

Electrical Requirements

USA: FT1380-115 standard machine uses 115V, 60 Hz, 1.5 hp

Brazil: FT1380-1-2 standard machine uses 230V, 60 Hz, 1 hp

Australia: FT1380-230 standard machine uses 230V, 50 Hz, 1 hp

Canada: FT1380-115 standard machine. Requires CSA (Canadian Standards Association) approval. The FT1380-115 is CSA approved and is so noted on the nameplate.

ProCrimp® 1380P



Perfect for maintenance and repair of all your hose needs and designed to be used in remote or portable stations, the ProCrimp 1380P will handle through -20 SAE100R12 hose and fittings. All die cages, crimp diameters and approved hose and fitting combinations are identical to Eaton's popular FT1380 crimper. Crimp diameters are controlled using a micrometer and specially designed hydraulic circuit that allows

for precise and adjustable finished crimp diameters.

The ProCrimp 1380P may be ordered separately or with your choice of three power options, including a high volume hand pump, an Air/Hydraulic power unit or a 12-volt DC power unit.

Ordering Instructions

- FT1380P-1-1** Machine with hand pump
- FT1380P-1-1-5** Machine with hand pump and 5 die cages
- FT1380P-1-1-8** Machine with hand pump and 8 die cages
- FT1380P-1-2** Machine with Air/Hydraulic pump
- FT1380P-1-2-5** Machine with Air/Hydraulic pump and 5 die cages
- FT1380P-1-2-8** Machine with Air/Hydraulic pump and 8 die cages
- FT1380P-1-3** Machine only
- FT1380P-1-3-5** Machine with 5 die cages
- FT1380P-1-3-8** Machine with 8 die cages
- FT1380P-1-4** Machine with 12 volt DC pump
- FT1380P-1-4-5** Machine with 12 volt DC pump and 5 die cages
- FT1380P-1-4-8** Machine with 12 volt DC pump and 8 die cages
- FT1380-4** Optional fitting backstop-kit includes backstop and $\frac{5}{32}$ " hex wrench. The backstop allows the 1380P to crimp PTFE hose and be utilized for a fitting locator to increase efficiency.

5 die cages

- FT1380-200-M150
FT1380-200-M210
FT1380-200-M240
FT1380-200-M320
FT1380-275-M370

8 die cages

- Include the 5 die cages plus:
FT1380-200-M180
FT1380-200-M280
FT1380-275-M465

ET1000 Portable, Light Duty, Positive Stop Crimp Machine

Eaton is proud to add the ET1000 crimp machine to its line of portable crimpers. While being our most economical crimp machine to-date, the new ET1000 machine boasts a broad crimp capability with an ease-of-use that is sure to please hose assemblers.

This new crimp machine has been approved to crimp:

- All 1-wire and 2-wire braided MatchMate Plus hoses in sizes 1/4" through 1 1/4" using MatchMate Plus TTC fittings.
- All 4-wire spiral MatchMate Plus hoses in sizes 3/8" through 1", using MatchMate Plus TTC12 fittings.

The new ET1000 crimp machine builds on the success of the prior FT1370 portable crimp machine by using the same basic frame and construction design, but employs a 2-piece split half collet assembly in lieu of the traditional ProCrimp die cages. The correct hose assembly crimp diameter is obtained by the use of a spacer ring that controls the stroke length of the cylinder during the crimping operation.

This new crimp machine may be ordered separately or with one of four power supplies: hand-pump, air/hydraulic pump, 12-volt DC power unit, or a 110-volt AC power unit.

Features

- Pusher slides out of position.
- Compatible with the Aeroquip MatchMate Plus hose and fittings.
- Can be mounted on service vehicles due to its portable design.
- Can be powered with virtually any 10,000 psi hydraulic power source (min. 36 cubic inch pump reservoir capacity).
- Utilizes 2-piece collet assemblies.
- Spacer rings control the crimp diameter.

Benefits

- Sliding pusher allows for easier fitting insertion into the machine.
- Simple positive-stop crimp diameter control system for consistent crimping time after time with no operator adjustments required.
- Easily transported between job sites.
- Versatile power source options.
- Electricity is required only when using an electric style pump.



Specifications

Dimensions-22 inches high, 16 inches wide, 14 inches in depth

Weight 70 lbs. (without pump)

ET1000 Crimp Machine Part Numbers

For tooling and crimping information, refer to the Collet/Spacer Ring Selector Chart, A-EQCR-MG001-E.

All part numbers include the basic crimp machine.

ET1000-001 = No pump, no tooling (basic machine only)

ET1000-002 = Hand-pump, no tooling

ET1000-003 = Air/hydraulic pump, no tooling

ET1000-004 = 110 volt 1/2HP electric pump, no tooling

ET1000-005 = 12 V DC pump, no tooling

ET1000 Crimp Machine Package Part Numbers

These machine packaged part numbers offer a variety of pumps with the same tooling package including all collets and spacer rings to crimp:

1-wire and 2-wire braided MatchMate Plus Hoses (sizes 1/4" through 1 1/4") using TTC fittings

GH493, 4-wire spiral MatchMate Plus Hose (sizes 3/8" through 1") using TTC12 fittings

ET1000-006 = No pump, but includes complete MatchMate Plus Collet and Spacer Ring Tooling package described above

ET1000-007 = Air/hydraulic pump, and complete MatchMate Plus Collet and Spacer Ring Tooling package described above

ET1000-008 = 110 Volt electric pump, and complete MatchMate Plus Collet and Spacer Ring Tooling package described above

ET1000-009 = 2-Stage hand pump, and complete MatchMate Plus Collet and Spacer Ring Tooling package described above

ET1000-010 = 12 Volt DC pump, and complete MatchMate Plus Collet and Spacer Ring Tooling package described above

ProCrimp® 1390



Crimped hose assembly machine

Hose Specifications

All styles from 3/16" through 2" I.D. including four and six spiral wire requiring internal skive crimp style fittings.

Features

- Front-end loading design
- Electronic key pad control of crimp diameter
- Power return stroke, return limit control
- Drop-in tooling (crimp die cages)
- Backstop fitting locator
- Width 29", Depth 28", Height 49", Weight 825 lbs.
- Worklamp

Ordering Instructions

FT1390-115 Aeroquip crimp machine, 115V, single phase, 60 Hz, 1 hp motor

FT1390-115-12 Kit includes FT1390-115 machine plus the die cages to crimp -4 through -32 MatchMate Plus fittings.

FT1092 NEVER-SEEZ lubricant

Electrical Requirements

Standard

115V, single phase, 60 Hz, 1 hp.

Optional 230 Volt Machines

FT1390-23050 230V, single phase, 50 Hz crimp machine

FT1390-23050-12 FT1390-23050 with 12 die cages.

FT1390-23060 230V, single phase, 60 Hz crimp machine

FT1390-23060-12 FT1390-23060 with 12 die cages.

Crimp Die Cages

Eaton crimp die cages provide simple "drop-in" tooling for the FT1390 crimp machine. See Crimp Die Cage Applications chart or contact Eaton. Refer to website for current crimp specifications.

Crimp Die Cage Storage Cabinet

Eaton recommends crimp die cages be kept free of dust or dirt. As an option, a cabinet is offered which has the capability of storing nine crimp die cages. Order by part number FT1283.

MatchMate Plus fitting locators

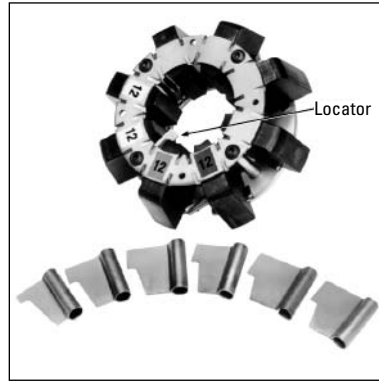

For use with FT1380 and FT1330 "M" Series die cages

Consistent crimping of MatchMate Plus fittings is greatly simplified when using new fitting locators. The locators are designed for easy installation and use on the Eaton FT1380 or FT1330 "M" series die cages noted below.

Ordering Instructions

The locator kits can be ordered as part number FT1330-XL. Each kit contains locators to accommodate -4, -6, -8, -10, -12 and -16 MatchMate Plus fittings and installation instructions.

Locator Suffix	Die Cage Suffix	MatchMate Plus Hoses			
		GH663, GH194	GH793, GH195	GH781	GH493
-4, -4P	-M150	-4	-4	-4	
-6, -6P	-M180	-6			
	-M210		-6	-6	-6
-8, -8P	-M240	-8	-8	-8	
-10, -10P	-M280		-10	-10	-8
-12, -12P	-M320	-12	-12	-12	-12
-16	-M370	-16	-16	-16	-16
None required	-M465		-20	-20	-20

SPECIALTY & TRUCK HOSE

LOW & MEDIUM PRESSURE HOSE

HIGH PRESSURE HOSE

HOSE FITTINGS

ADAPTERS & TUBE FITTINGS

ACCESSORIES & ASSEMBLY INSTRUCTIONS

HOSE ASSEMBLY EQUIPMENT

APPENDICES

Crimp Cages for FT1380

M-Series Crimp Die Cage Applications

Die Cage Part Number	Crimp Range	
	mm	in
FT1380-275-M070	7,0 to 9,0	0.28 to 0.35
FT1380-275-M090	9,0 to 12,0	0.35 to 0.47
FT1380-275-M120	12,0 to 15,0	0.47 to 0.59
FT1380-200-M150*†	15,0 to 18,0	0.59 to 0.71
FT1380-200-M180*†	18,0 to 21,0	0.71 to 0.83
FT1380-200-M210*†	21,0 to 24,0	0.83 to 0.95
FT1380-200-M240*†	24,0 to 28,0	0.95 to 1.10
FT1380-200-M280*†	28,0 to 32,0	1.10 to 1.26
FT1380-200-M320*†	32,0 to 37,0	1.26 to 1.46
FT1380-275-M370*	37,0 to 42,0	1.46 to 1.66
FT1380-275-M420	42,0 to 46,5	1.66 to 1.83
FT1380-275-M465*	46,5 to 52,0	1.83 to 2.05

†:Can be ordered as FT1380-275-SIZE for tool steel dies vs. powdered metal dies.

*FT1380-115-8 kit includes these 8 die cages.

NOTE: Additional dies and die cage assemblies also available.

Refer to website or contact Eaton.

Barrel Crimp Die Cage Applications

Die Cage Part Number	Hose Size	Hose Styles
FT1380-275-R5-04	-04	SAE100R5
FT1380-275-R5-05	-05	
FT1380-275-R5-06	-06	
FT1380-275-R5-08	-08	
FT1380-275-R5-10	-10	
FT1380-275-R5-12	-12	
FT1380-275-R5-16	-16	
FT1380-275-R5-20	-20	

Hose Styles

- Smooth Bore PTFE
- SAE100R1AT
- SAE100R2AT
- HI-PAC
- SAE100R6
- SAE100R8
- SAE100R17
- Convoluted PTFE
- SAE100R1
- SAE100R2A
- SAE100R4
- SAE100R7
- SAE100R12
- Polyon

For crimp specifications on Global Skive type fittings and Global TTC & TTC12 refer to website or contact Eaton for specialty hoses.

Die Cage Repair Kit Complete kit, less dies.

To Repair	Order
FT1380-200-size	FT1380-2-9
FT1380-275-size	FT1380-2-9
FT1380-201-size	FT1380-2-9A

Tooling Compatability Chart

Crimp Machines

	FT1008	FT1049	FT1204	FT1208	FT1209	FT1244	FT1307	FT1310	FT1320	FT1330	FT1340	FT1360	FT1370	FT1380	FT1380P	FT1390	ET1000
FT1008-100-Size	X																
FT1049-100-Size		X															
FT1204-100-Size			X		X ¹	X	X ¹				X ¹	X ¹				X ¹	
FT1208-100-Size				X													
FT1209-200-Size					X		X				X	X				X	
FT1307-200-Size					X		X				X	X				X	
FT1310-200-Size								X									
FT1330-200-Size									X	X							
FT1330-275-Size									X	X							
FT1380-200-Size													X	X	X		
FT1380-201-Size													X	X	X		
FT1380-275-Size													X	X	X		
FT1390-200-Size					X		X				X	X				X	
ET1000-Size																	X

¹ Individual dies. Requires the use of die cage kit FT1307-2-9 or removable die cage FT1307-2-13.

Crimp Cages for FT1390

FT1307-200-Size, FT1209-200-Size & FT1390-200-Size die cages can be used in the FT1390 crimp machine.

Die Cage Part Number	Crimp Range	
	mm	in
FT1307-200-M070	7,0 to 9,0	0.28 to 0.35
FT1307-200-M090	9,0 to 12,0	0.35 to 0.47
FT1307-200-M120	12,0 to 15,0	0.47 to 0.59
FT1307-200-M150*	15,0 to 18,0	0.59 to 0.71
FT1307-200-M180*	18,0 to 21,0	0.71 to 0.83
FT1307-200-M210*	21,0 to 24,0	0.83 to 0.95
FT1307-200-M240*	24,0 to 28,0	0.95 to 1.10
FT1307-200-M280*	28,0 to 32,0	1.10 to 1.26
FT1307-200-M320*	32,0 to 37,0	1.26 to 1.46
FT1307-200-M370*	37,0 to 42,0	1.46 to 1.66
FT1307-200-M420*	42,0 to 46,5	1.66 to 1.83
FT1307-200-M465*	46,5 to 52,0	1.83 to 2.05
FT1307-200-M520*	52,0 to 55,0	2.05 to 2.17
FT1307-200-M550*	55,0 to 69,0	2.17 to 2.71
FT1307-200-M690*	69,0 to 73,0	2.72 to 2.87

†: Can be ordered as FT1380-275-SIZE for tool steel dies vs. powdered metal dies.

*FT1390-115-12 kit includes these 12 die cages.

NOTE: Additional dies and die cage assemblies also available. Refer to website or contact Eaton.

NOTE: FT1209-200-Size & FT1390-200-Size are for use with internal skive and Global Spiral TTC fittings (SAE100R11 & SAE100R13 hose styles).

NOTE: FT1390-200-Size dies cages are hinged to allow ease of use when crimping large elbows.

NOTE: All dies are machined from tool steel.

Hose Styles

- Smooth Bore PTFE
- Polyon
- SAE100R1
- SAE100R2A
- SAE100R4
- SAE100R7
- SAE100R12
- Convoluted PTFE
- SAE100R1AT
- SAE100R2AT
- HI-PAC
- SAE100R6
- SAE100R8
- SAE100R17

For crimp specifications on Global Skive type fittings and Global TTC & TTC12 refer to website or contact Eaton for specialty hoses.

Barrel Crimp Die Cage Applications

Die Cage Part Number	Hose Size	Hose Styles
FT1307-200-R5-04	-04	SAE100R5
FT1307-200-R5-05	-05	
FT1307-200-R5-06	-06	
FT1307-200-R5-08	-08	
FT1307-200-R5-10	-10	
FT1307-200-R5-12	-12	
FT1307-200-R5-16	-16	
FT1307-200-R5-20	-20	
FT1307-200-R5-24	-24	
FT1307-200-R5-32	-32	

Die Cage Repair Kit Complete kit, less dies.

To Repair	Order
FT1307-200-size	FT1307-2-9
FT1390-200-size	FT1390-2-9
FT1209-200-size	FT1209-2-9

Crimp Collets and Spacers for ET1000

Collet Part Numbers
ET1000DC-M150S
ET1000DC-M195S
ET1000DC-M230S
ET1000DC-M250S
ET1000DC-M295S
ET1000DC-M320S
ET1000DC-M390S
ET1000DC-M430S
ET1000DC-M475S

Spacer Ring Part Numbers
ET1000SR-M115D (Yellow)
ET1000SR-M265D (Black)
ET1000SR-M395D (Silver)
ET1000SR-M190D (Lt. Green)
T-400-37 (Green)
T-400-38 (Red)
ET1000SR-M100A (Purple)
ET1000SR-M315A (Orange)
T-400-112 (Tan)

Accessory Part Numbers
1.5 oz. tube of high efficiency PTFE grease = 140-06701

Die Ring Adapter - For Smaller Collets
ET1000AR-001

Reusable Assembly Equipment

FT1097 Portable reusable hose assembly machine

Fitting Specifications

- Any screw together reusable hose fitting with a hex size $2\frac{1}{8}$ " or smaller

Features

- Bench or stand mounted
- Easy to operate
- Convenient foot switch
- U.L. listed
- 102 RPM

Ordering Instructions

Machine:

- FT1097-1-1** Base machine, 110V
- FT1097-1-2** Base machine, 220V
- FT1013-2-2** Machine stand
- FT1220-10** Optional assembly tool kit (see page 317)
- FT1097-2-1** Optional vise kit (see below)

Electrical Requirements

1/2 hp reversible, variable speed, universal motor; as the torque increases the speed decreases. 110V AC, single phase, 25-60 Hz, or 220V, AC, single phase, 25-60 Hz.



FT1097-2-1 Vise kit for FT1097 machine



The optional vise kit for the FT1097 reusable hose assembly machine includes all hardware necessary to install the kit. Reusable hose fitting sockets are conveniently held secure during assembly.

FT1013 Portable reusable hose assembly machine

Fitting Specifications

- Fabric and single wire braid, -04 through -40
- Double wire and 4-spiral wire, -04 through -32



Features

- Quick acting wrench type chuck
- Easy to operate
- Safety guard
- Versatile
- Safety snap type switch
- Safety footswitch
- 36 rpm
- 45" x 56" x 46", 170 lbs.

Ordering Instructions

FT1013-1-5	Base machine, 110V, with vise
FT1013-1-6	Base machine, 220V, with vise
FT1013-1-3	Base machine, 110V, with stand, vise and socketing tool
FT1013-1-4	Base machine, 220V, with stand, vise and socketing tool
FT1013-1-1	Base machine, 110V, with tool kit, stand, vise and socketing tool
FT1013-1-2	Base machine, 220V, with tool kit, stand, vise and socketing tool
FT1013-2-1	Vise
FT1013-2-2	Stand
1562	Tool kit
FT1281	Socketing tool (see below)

Electrical Requirements

1/2 hp reversible, variable speed, universal motor; as the torque increases the speed decreases. 110V AC, single phase, 25-60 Hz, or 220V AC, single phase, 25-60 Hz.

FT1281 Socketing tool



For use with stand mounted FT1013 and FT1097 Portable Hose Assembly Machine. (The FT1281 socketing tool must be accompanied by the FT1097-2-1 vise kit (see page 381) when used on the FT1097 portable hose assembly machine.)

FT1028 Production reusable hose assembly machine

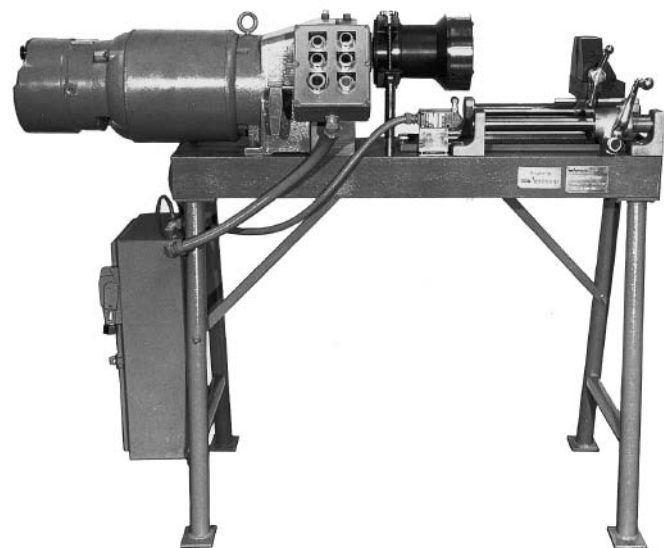

Fitting Specifications

- Screw together fittings—Fabric or wire braided hose up to -32
- Screw together fittings—4 spiral wire hose up to -24

Features

- High volume production
- Ideal for 2 or 3 piece fittings
- 4 speed transmission; 90 rpm, 120 rpm, 210 rpm, 400 rpm
- Easy to operate
- Micrometer stop
- Electric brake
- U.L. listed
- 24" x 62" x 32", 550 lbs.

Electrical Requirements: 220/440V, 3 phase, 60 Hz.

Ordering Instructions

FT1028-1-5 Base machine with automatic stop and spindle control

FT1234 Drop-in socket holder



The FT1234 drop-in socket holder is designed for the FT1028 assembly machine. They prevent rotation of the socket during assembly and provide a back stop to ensure consistent location of the socket.

Part No. FT1234	Hex Size (in.)	Hose Style	Socket Part Number and Size
-100	9/16	2807-4	1206-4
-101	5/8	2807-5, 1503-4, FC300-04 FC350-04, FC321-04	1206-5, 1210-4
-102	11/16	2807-6, 1503-5, FC300-5, FC350-5, FC321-05	1206-6, 1210-5
-104	13/16	1503-6, 1509-4, FC300-6, FC350-6, FC321-06	1210-6, 4010-4
-105	7/8	2807-8	1206-8
-106	15/16	1503-8, FC300-08, FC350-08, FC321-08	1210-8
-200	1	2807-10	1206-10, FC3214-10
-201	1	FC136-6, 1509-6, 1508-6	4007-6, 4010-6, 4013-6
-202	1 1/8	1503-10, 1509-8, 1508-8, FC300-10, FC350-10, FC321-10	4013-8
-203	1 1/8	2807-12	1206-12
-204	1 1/4	1503-12, 1509-10, FC300-12, FC350-12	1210-12, 4010-10
-205	1 3/8	2807-16	1212-16, FC3214-16
-206	1 7/16	1503-16, FC300-16, FC350-16, FC321-16	1212-16
-207	1 1/2	FC136-12, 1508-12	4007-12, 4013-12
-208	1 5/8		FC3214-20
-209	1 3/4	1503-20, FC300-20,	1212-20 FC350-20

FT1033 Assembly mandrels

The FT1033 assembly mandrels are exclusively designed for use with the FT1028 assembly machine. Secured in the chuck they speed the volume production of Eaton Aeroquip three piece reusable hose fittings.

Part Number	Fitting Number	Part Number	Fitting Number
FT1033-1	FC9215-0404	FT1033-23	401-6
FT1033-2	FC9215-0504	FT1033-24	411-6
FT1033-3	FC9215-0808	FT1033-25	411-8 401-8
FT1033-4	FC9215-0506	FT1033-26	411-10 401-10
FT1033-5	FC9215-1010	FT1033-27	401-12
FT1033-6	FC9210-0606	FT1033-28	411-12
FT1033-7	FC9210-1212	FT1033-29	406-16
FT1033-8	FC9211-0606	FT1033-30	411-16
FT1033-9	FC9211-1212	FT1033-31	406-20
FT1033-10	FC9211-1616	FT1033-32	411-20
FT1033-11	FC9211-2020	FT1033-33	406-24
FT1033-13	FC9212-0204 FC9212-0404 FC9216-0404	FT1033-34	411-24
FT1033-14	FC9212-0406 FC9212-0606	FT1033-35	406-32
FT1033-15	FC9212-0608 FC9212-0808	FT1033-36	411-32
FT1033-16	FC9212-0810	FT1033-37	412-2-4 412-4-4
FT1033-17	FC9212-1212	FT1033-38	412-4-5
FT1033-18	FC9212-1616	FT1033-39	412-4-6
FT1033-19	FC9212-2020	FT1033-40	412-6-12
FT1033-21	411-4 401-4	FT1033-41	412-8-10 412-12-10
FT1033-22	411-5 401-5	FT1033-42	412-12-12

FT1271 Split flange assembly tooling

Specifications

The Eaton designed FT1271 split flange tooling is specifically designed for the FT1028 assembly machine. This tooling makes it easier to secure split flange hose fitting nipples in the chuck of the assembly machine.



FT1095 Elbow reusable fitting holders

Specifications

The optional FT1095 elbow fitting holders will allow the operator to make double elbow hose assemblies on the FT1097 assembly machine and can be used with the FT1028 machine.

Ordering Instructions

Part Number	Nipple Hex Size	For Use With Nipples Marked	Adapter Required For FT1028 Machine
FT1095-100-1	3/8	MP-4	FT1095-101
FT1095-100-2	7/16	MP-5	
FT1095-100-3	1/2	MP-6, HP-4	
FT1095-100-4	5/8	MP-8, HP-6	
FT1095-150-1	11/16	HP-8	FT1095-151
FT1095-150-2	3/4	MP-10	
FT1095-150-3	7/8	MP-12	
FT1095-150-4	15/16	HP-12	
FT1095-150-5	1 1/8	MP-16	
FT1095-150-6	1 1/4	HP-16	
FT1095-150-7	1 3/16	HP-10	
FT1095-200-1	1 3/8	MP-20	FT1095-201
FT1095-200-2	1 5/8	HP-20	

FT1220-10 Reusable fitting assembly mandrels



Specifications

The FT1220-10 kit includes all assembly mandrels listed for -4 through -20 for the assembly of Eaton 411, 401, and 406 reusable hose fittings. Individual mandrels may also be ordered by using the part numbers to the right.

Thread type	SAE 37° (JIC)	SAE 45° PTT	30°
Use with fitting Nos.	411	401	406
Dash size			
-4	1582-4S	1582-4S	
-5	1582-5S	1582-5S	
-6	583-6S	1582-6S	
-8	1582-8S	1582-8S	
-10	1582-10S	1582-10S	
-12	583-12S	1582-12S	
-16	1563-16S		1561-16S
-20	1563-20S		1561-20S
-24	1563-24S		1561-24S
-32	1563-32S		

Kit Part Number	Fitting Part Number	Thread Types	Size Range
1562 (not shown)	401, 406, 411, 412	SAE 45°, SAE 37° (JIC), PTT, NPTF	-4 thru -32
1597 (not shown)	401, 412	SAE 45°, NPTF	-4 thru -12
1598 (not shown)	411, 412	SAE 37° (JIC), NPTF	-4 thru -32
1599 (not shown)	411, 412	SAE 37° (JIC), NPTF	-4 thru -12
FT1220-10	401, 406, 411, 412	SAE 45°, SAE 37° (JIC), PTT, NPTF	-4 thru -20

F2015 SOCKETLESS fitting bench mounted assembly machine



Hose Specifications

- SOCKETLESS hose, all sizes

Features

- Fast, hand assembly
- Bench mounted
- Hose is securely held
- Mandrels included

Ordering Instructions

F2015 Complete machine

FT1081 PTFE hose assembly tool kit

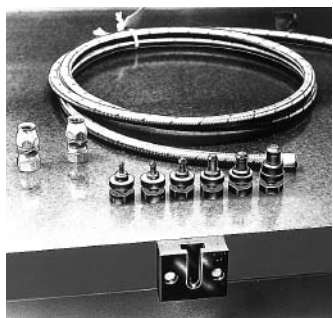

Hose Specifications

Smooth Bore PTFE Hose, -03, -04, -05, -06, -08, -10 and -12 hose. FT1090-3-10-4 and FT1090-3-10-5 are useful wire flare tools to use in conjunction with kit FT1081.

Features

- Inexpensive
- Easy to use
- Seats PTFE tube against sleeve

Ordering Instructions

FT1081 Complete tool kit

Includes:

- FT1081-3-1** mandrel holder
- FT1081-3-2-3** mandrel -3 hose
- FT1081-3-2-4** mandrel -4 hose
- FT1081-3-3-5** mandrel -5 hose
- FT1081-3-4-6** mandrel -6 hose
- FT1081-3-5-8** mandrel -8 hose
- FT1081-3-6-10** mandrel -10 hose
- FT1081-3-7-12** mandrel -12 hose
- FT1081-16** mandrel -16 hose
- FT1081-20** mandrel -20 hose

FT1038A PTFE hose tool



Hose Specifications

- Smooth bore PTFE Hose, -03, -04, -05, -06, -08, -10 and -12

Features

- Small
- Hand held tool

Ordering Instructions

- FT1038A** PTFE Hose Tool (-03 thru -12)
- FT1038B** PTFE Hose Tool (-16, -20)

Hose Cut Off Equipment

FT1258 Cut off tool



Specifications

FT1258 bench mounted cut off tool. A bench mounted cutter for in-plant production of Polyon hose assemblies and other fabric reinforced hose styles.

Ordering Instructions

FT1258 Cut-off tool

FT1258-2-2 Blade kit

Package of three replacement blades for FT1258 tool which are designed to cut all fabric reinforced hose including Kevlar.*

**Kevlar is a trademark of E.I. DuPont.*

FT1500 Machine



Features:

- Powerful 4.2-hp high torque motor for faster and easier cutting
- Clear face shield guard for added safety
- Includes mounting hardware and protective goggles

- Standard 14" scalloped blade:
 - Cuts 1- and 2-wire braided hose through 2" I.D.
 - Cuts 4-wire spiral hose through 2" I.D.
 - Cuts 6-wire spiral hose through 1-1/2" I.D.
 - Lasts longer by dissipating heat/reducing friction
 - Blade can be reversed for added blade life
 - New blade sharpening service agreement

Ordering Instructions

Machine:

FT1500 Includes machine with 14" scalloped blade

• **Optional Cutting Blades:**

- **FT1500-1** Scalloped blade is standard
- **FT1500-2** Smooth beveled blade cuts Stainless Steel braided cover hose.
- **FT1500-4** Scalloped toothed blade cuts Industrial Fluid Transfer hoses through 4" I.D.

SPECIALTY &
TRUCK HOSE

LOW & MEDIUM
PRESSURE HOSE

HIGH PRESSURE HOSE

HOSE FITTINGS

ADAPTERS &
TUBE FITTINGS

ACCESSORIES &
ASSEMBLY INSTRUCTIONS

HOSE ASSEMBLY
EQUIPMENT

APPENDICES

S1104
Hose cut off machine



Hose Specifications

- Single and Double Wire Reinforced, 1/4" to 3" I.D.
- Four and Six Spiral Wire Reinforced, 1/4" to 1 1/2" I.D. with optional blades FT1101-1 and FT1101-2, spiral wire capacity is increased to 2"

Features

- Compact, 22" x 24"
- Light, 130 lbs.
- Dual V-belt drive
- 10" cutting blade
- U.L. listed

**A 3 hp, 230V AC, single phase machine is also available but not recommended because of reduced torque and less capability when cutting larger size hose. Order by part number S1104-230.*

Electrical Requirements

3 hp, 230/460V, 3 phase, 60 Hz.

Machine wired for 230V AC. Change connections as shown on motor plate for 460V. Also, replace 230V motor heater with 460V motor heater included with machine.

Ordering Instructions

Machine:

S1104 Basic machine, 230/460V, 3 phase, 60 Hz

S1026 Hose measuring gauge attachment

FT1215 Hose reel attachment

S1118 Coolant spray system (required when cutting spiral wire hose)

SC1709 10" Replacement cutting blade

SC1772 Welded steel table

Optional Cutting Blades

FT1101-1

10" Scalloped Blade

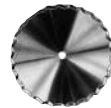

FT1101-2

10" Abrasive Blade

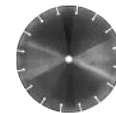

FT1260
Hose cut off machine



Hose Specifications

- All Hose Constructions – 1/4" to 4" I.D.

Features

- Built in safety features
- Easy to operate
- 16" abrasive wheel
- Heavy duty design
- Low maintenance
- V shaped vise
- U.L. listed

Ordering Instructions

Machine:

FT1260-1-1 Base machine with stand. 230/460V, 3 phase, 60 Hz

FT1260-1-2 Base machine with stand and fume exhauster. 230/460V, 3 phase 60 Hz

FT1260-1-3 Base machine with stand. 230V, single phase, 60 Hz

FT1260-1-4 Base machine with stand and fume exhauster. 230V, single phase, 60 Hz

FT1260-2-5 Optional hood (can be used only with the -1-2 and the -1-4 models) Eaton recommends the use of FT1260-2-5, optional hood.

Replacement Components:

FT1260-3-1

Replacement 16" fiberglass reinforced abrasive wheel

Electrical Requirements

Electrical requirements will vary depending on options selected.

Contact Eaton for additional information.

**S1120
Hose preparation package**



SPECIALTY &
TRUCK HOSE

LOW & MEDIUM
PRESSURE HOSE

HIGH PRESSURE HOSE

HOSE FITTINGS

ADAPTERS &
TUBE FITTINGS

ACCESSORIES &
ASSEMBLY INSTRUCTIONS

HOSE ASSEMBLY
EQUIPMENT

APPENDICES

Hose Specifications

Cutting 3/16" to 3"
Skiving 1/4" to 2"

Features

- Fast, efficient hose cutting
- 10" cutting blade
- Easily adjusted, self-contained skiving mandrels for reusable fittings
- Safe collection of skived rubber
- Spray system prolongs blade life
- Rotary hose reel for easy hose handling
- 24" x 42" x 24", 240 lbs.
- Double V belt cutting drive
- Direct skiving drive

Electrical Requirements

3 hp (in S1102 machine saw), 1/3 hp (in dust collector), 230/460V AC, 60 Hz, 3 phase

Blade Selection

Eaton offers three different cutting blades to make cutting of wire braid and spiral wire hose quick and easy.

Ordering Instructions

The S1120 hose preparation package may be ordered as a complete assembly or the five different components of the package may be ordered individually.

S1120* Hose Preparation Package

S1102* Includes: Basic Cut Off and Skiving Machine

S1043* Collector and Table

S1026 Hose Measuring Gauge Attachment

FT1215 Hose Reel Attachment

S1118 Coolant Spray System

SC1681 (Optional) Replacement Skiving Brush

*A 3 hp 230V AC single phase motor is also available but not recommended due to reduced torque and less capability in cutting larger size hose. The following part numbers must be used when ordering components with single phase motors:

S1120-230 Hose Preparation Package

S1102-230 Basic Cut Off and Skiving Machine

S1043-230 Dust Collector and Table



SC1709

Standard replacement cutting blade (one included with each machine).



FT1101-1

Scalloped cutting blade (optional; used for cutting spiral wire hose).

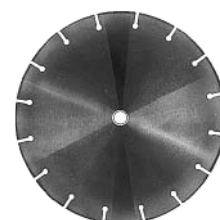

FT1101-2

Abrasive cutting blade (optional; used for cutting spiral wire hose).

Skiving Equipment

Skiving Tools

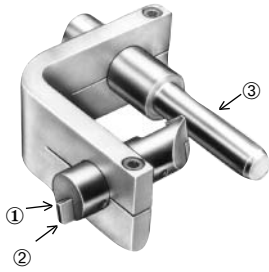

FT1229-Size

Silver Chromate Mandrel
(for reusable fittings)

- ① FT1229-2-3 blade holder
- ② FT1229-3-4 skive blade
- ③ FT1229-100-size

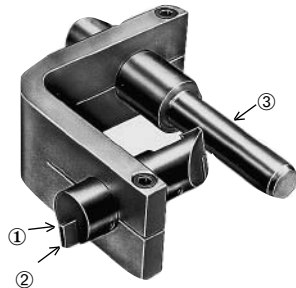

FT1230-Size

Yellow Chromate Mandrel
(for crimp fittings)

- ① FT1229-2-3 blade holder
- ② FT1229-3-4 skive blade
- ③ FT1230-100-size

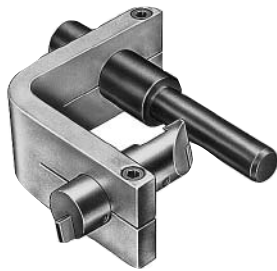

FT1231-Size

Black Oxide Mandrel
(for internal skive crimp fittings)

For skiving rubber covered wire reinforced hoses

When selecting skive tools, refer to Eaton document A-EQCR-TM001-E for proper skive length of hose sizes.

Hose Size	Reusable Fittings		Crimp Fittings		Crimp Internal Skive Fittings	
	FT1229	Skive Length	FT1230	Skive Length	FT1231	Skive Length
-03			-3	0.45		
-04	-4	0.91	-4	0.76		
-05			-5	0.76		
-06	-6	1.15 1.23 1.30	-6	.90		
-08	-8	1.25	-8	1.04	-8	1.34
-10	-10	1.25	-10	1.11		
-12	-12	1.40	-12 ¹	1.21 1.31	-12	1.40
		-12B ³		2.40		
-16	-16	1.65 2.30	-16	1.30	-16	1.85
		-16B ³				
-20	-20	2.09	-20 ¹	1.66 1.52 1.88	-20	2.05
		-20A ⁴		2.60		
		-20B ³		2.75		
-24	-24	1.95	-24 ¹	1.74 1.64 2.18	-24	2.05
		-24B ⁵		2.60		
-32	-32 ²	2.05			-32	2.30

¹Adjustable tool.

²FT1229-32 tool is used for reusable and crimp fittings.

³For FC606.

⁴For FC136.

⁵For FC136 and FC254.

FT1240 Internal skive tooling



FT1240-100-Size



FT1240-150-Size

* When tooling begins to wear, contact customer service for information on how to exchange for sharpened tooling.

Internal Skive Tool	FC136	FC254	FC323 FC324 FC273	FC325	FC606
FT1240-150-8		-08			
FT1240-100-12			-12	-12	
FT1240-150-12		-12			
FT1240-150-16	-16	-16	-16	-16	-16
FT1240-100-20	-20		-20	-20	
FT1240-150-20		-20			-20
FT1240-100-24	-24		-24	-24	
FT1240-150-24		-24			
FT1240-100-32	-32		-32	-32	
FT1240-150-32		-32			

FT1279 Auger attachment



The FT1279 auger attachment permits efficient skiving of rubber covered wire reinforced hose.

Designed for use with FT1229, FT1230 and FT1231 skiving tools, the FT1279 auger attachment promotes quick completion of hand skiving operations.

SPECIALTY & TRUCK HOSE
LOW & MEDIUM PRESSURE HOSE
HIGH PRESSURE HOSE
HOSE FITTINGS
ADAPTERS & TUBE FITTINGS
ACCESSORIES & ASSEMBLY INSTRUCTIONS
HOSE ASSEMBLY EQUIPMENT
APPENDICES

Hose Proof Test Stands

FT1312 Hose proof test stand



Hose Specifications

Assembles up to 2" I.D.,
6 spiral wire

Features

- Designed to use tap water, eliminating the need for a special test fluid
- Compact power unit is air driven
- Air regulator and gauge provide easy pressure adjustment and monitoring
- Tough transparent Lexan* lid
- 79" x 36" x 53", 550 lbs.

Power Unit

The power unit of the FT1312 tester is a compact, economical air driven hydraulic pump. It will provide sufficient hydraulic pressure to proof test any Aeroquip hose assembly, up to 22,000 psi.

**Lexan is a General Electric trademark.*

FT1261 Hose proof test stand



Hose Specifications

Assembles up to 2" I.D.,
6 spiral wire in 50 ft. coil lengths

Features

- Designed to use tap water, eliminating the need for a special test fluid
- Air regulator and gauge provide easy pressure adjustment and monitoring
- Tough transparent Lexan* lid
- 96" x 84" x 54", 800 lbs.

Power Unit

The power unit of the FT1261 tester is a compact, economical air driven hydraulic pump. It will provide sufficient hydraulic pressure to proof test any Aeroquip hose assembly, up to 22,000 psi.

**Lexan is a General Electric trademark.*

FT1312 and FT1261 Standard adapter selection chart

Hose Fitting* Style and Size	Fitting Adapter Part Number	Pressure Port Adapter Part Number	Plug or Cap Part Number
SAE 37° (JIC) Swivel			
-4	2027-8-4S	**	900599-4
-5	2021-6-5S	2081-12-6S	900599-5
-6	2027-8-6S	**	900599-6
-8	2027-8-8S	**	900599-8
-10	2027-10-8S	**	900599-10
-12	2027-8-12S	**	900599-12
-16	2021-12-16S	**	900599-16
-20	2021-16-20S	2040-12-16S	900599-20
-24	2021-16-24S	2040-12-16S	900599-24
-32	2021-16-32S	2040-12-16S	900599-32
SAE 45° Swivel			
-4	2000-6-4B	2081-12-6S	900599-4
-5	2000-6-5B	2081-12-6S	900599-5
-6	2000-6-6B	2081-12-6S	2001-6-6B, 2082-6S
-8	2000-12-8B	**	900599-8
-10	2000-12-10B	**	900599-10
-12	2000-12-12B	**	2001-8-12B, 2082-8S
Male Pipe			
-2	2081-8-2S	2081-12-8S	2046-2-2S, 2082-2S
-4	2081-8-4S	2081-12-8S	2046-4-4S, 2082-4S
-6	2081-8-6S	2081-12-8S	2046-6-6S, 2082-6S
-8	2081-8-8S	**	2046-8-8S, 2082-8S
-12		**	2046-12-12S, 2082-12S
-16	2040-12-16S	**	2046-16-16S, 2082-16S
-20	2040-16-20S	2040-12-16S	2046-20-20S, 2082-20S
-24	2040-20-24S	2040-12-16S, 2040-16-20S	2046-24-24S, 2082-24S
-32	2040-24-32S	2040-12-16S, 2040-16-20S, 2040-20-24S	2046-32-32S, 2082-32S

**Two adapters are required per hose assembly to be tested.*

***Internal Skive Fittings Only.*

SPECIALTY &
TRUCK HOSE

LOW & MEDIUM
PRESSURE HOSE

HIGH PRESSURE HOSE

HOSE FITTINGS

ADAPTERS &
TUBE FITTINGS

ACCESSORIES &
ASSEMBLY INSTRUCTIONS

HOSE ASSEMBLY
EQUIPMENT

APPENDICES

FT1058 Hose proof test stand



Features

- Pressure gauge
- Release valve
- Hand hydraulic pump
- Foot switch
- Fluid reservoir, use SAE 5 wt. hydraulic oil (oil not included)
- Electric fluid pump
- Safety lid
- Pressure port (3/4-14 NPTF Female Port)
- 42" x 22" x 9" (41" with legs), 75 lbs.
- 10,000 psi maximum proof pressure

Electrical Requirements

110V 60 Hz, single phase motor

Ordering Instructions

FT1058 as shown above. Legs can be removed for bench mounting.

FT1058 Adapter selection chart

Hose Fitting* Style and Size	Fitting Adapter Part Number	Pressure Port Adapter Part Number	Plug or Cap Part Number
SAE 37° (JIC) Swivel			
-4	2021-6-4S	2081-12-6S	900599-4
-5	2021-6-5S	2081-12-6S	900599-5
-6	2021-12-6S		900599-6
-8	2021-12-8S		900599-8
-10	2021-12-10S		900599-10
-12	2021-12-12S		900599-12
-16	2021-12-16S		900599-16
-20	2021-16-20S	2040-12-16S	900599-20
-24	2021-16-24S	2040-12-16S	900599-24
-32	2021-16-32S	2040-12-16S	900599-32
SAE 45° Swivel			
-4	2000-6-4B	2081-12-6S	900599-4
-5	2000-6-5B	2081-12-6S	900599-5
-6	2000-6-6B	2081-12-6S	2001-6-6B, 2082-6S
-8	2000-12-8B		900599-8
-10	2000-12-10B		900599-10
-12	2000-12-12B		2001-8-12B, 2082-8S
Male Pipe			
-2	2081-8-2S	2081-12-8S	2046-1-2S, 2082-2S
-4	2081-8-4S	2081-12-8S	2046-4-4S, 2082-4S
-6	2081-8-6S	2081-12-8S	2046-6-6S, 2082-6S
-8	2081-12-8S		2046-8-8S, 2082-8S
-12			2046-12-12S, 2082-12S
-16	2040-12-16S		2046-16-16S, 2082-16S
-20	2040-16-20S	2040-12-16S	2046-20-20S, 2082-20S
-24	2040-20-24S	2040-12-16S, 2040-16-20S	2046-24-24S, 2082-24S
-32	2040-24-32S	2040-12-16S, 2040-16-20S, 2040-20-24S	2046-32-32S, 2082-32S

*Adapters are available for other hose fitting styles. Contact Eaton.

Appendices Index

Alphabetical Index

DESCRIPTION	PAGES	DESCRIPTION	PAGES	DESCRIPTION	PAGES	DESCRIPTION	PAGES
Agency Listings	346	Flow Capacity Pressure Drop Chart	357	How to Identify and Measure Fluid Connectors	362	SAE Recommended Practices	356
Analyzing Hose Failures	359	Fluid Compatibility	349	Hydraulic Tubing Info	376	Service Life Routing Installation Instructions	358
Fitting Assembly Torque Values	376	Hose Size to Maximum Operating Pressure	345			Technical Data	343

SPECIALTY &
TRUCK HOSE

LOW & MEDIUM
PRESSURE HOSE

HIGH PRESSURE HOSE

HOSE FITTINGS

ADAPTERS &
TUBE FITTINGS

ACCESSORIES &
ASSEMBLY INSTRUCTIONS

HOSE ASSEMBLY
EQUIPMENT

APPENDICES

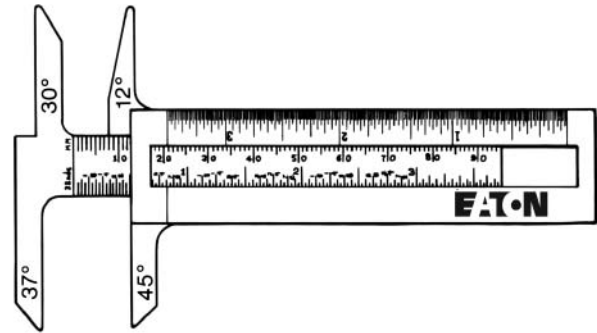
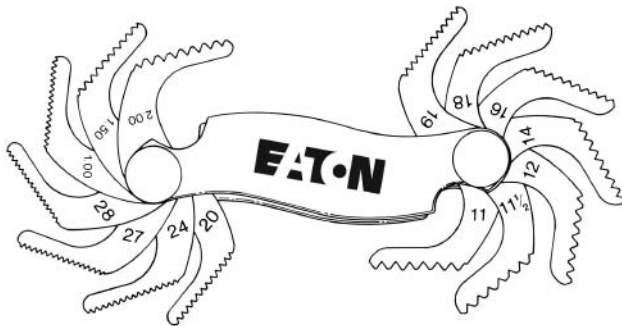

Hose Dash Size to Maximum Operating Pressure

See pages 349-355 for Fluid Compatibility

Hose tube identification chart

1. Synthetic rubber
2. PTFE
3. Thermoplastic
4. AQP
5. Special application hose
6. EPDM

Pressures expressed in psi/bar.

HOSE TO FITTING PAGE REFERENCE CHART

Hose Part Number	Page	Tube	Hose -02	-03	-04	-05	-06	-08	-10	-12	-16	-20	-24	-32	-40	-48
FC252	0	5					50/3	50/3	40/3	40/3	35/2					
FC352*	0	5						100/7	100/7	100/7	90/6	85/6	85/6	75/5	60/4	50/3
2550	0	5					225/16									
2554	0	5					225/16									
2570	0	5					225/16	225/16	225/16							
FC829	0	6						225/16								
FC629	0	1					225/16	225/16								
2575	0	1			250/17		250/17	250/17	200/14	200/12						
FC647	0	1			360/25		300/21	300/21	250/17	250/17						
2556	0	1			360/25		300/21	300/21	250/17	250/17						
FC332	0	4			250/17		250/17	250/17	250/17	250/17						
2565	0	1			300/21		250/17	200/14	175/12	125/9						
1531	0	5							300/21	300/21	300/21	300/21				
1531A	0	5											300/21			
2661*	0	4								300/21††	250/17††	200/14††	150/10††	100/7††	62/4	56/4
FC619	0	1								300/21††	250/17††	200/14††	150/10††	100/7††	62/4	56/4
CR170	0	5			350/24		350/24	350/24		350/24						
FC321	0	5			350/24	350/24	350/24	350/24	350/24	350/24	350/24					
FC498	0	4			400/28		400/28	400/28	350/24	350/24						
FC598	0	4			400/28		400/28	400/28	350/24	350/24						
FC466	0	1			400/28		400/28	400/28	350/24	350/24						
FC699	0	5			400/28		400/28	400/28	350/24	350/24	250/17					
302A	0	1									800/55	600/41	500/34	350/24		
2580	0	1			1000/69	800/55	650/45	625/43	600/41	550/38	500/34	450/31	400/28	350/24		
2583	0	1			1250/86		1125/78	1000/69		750/52	565/39	375/26				
FC650	0	4			1000/69		1000/69	1000/69	1000/69	1000/69						
FC364	0	2						1250/86		1100/76	1000/69	1000/69	750/52	500/34	100/7	100/7
FC363	0	2						1250/86		1100/76	1000/69	1000/69	750/52	500/34		
FC355	0	4			1500/103	1500/103	1500/103	1250/86	1250/86	750/52	400/28	300/21	250/17	200/14		
FC234	0	5				1500/103	1500/103	1250/86	1250/86	750/52	400/28					
FC350	0	4			2000/138	1500/103	1500/103	1250/86	1250/86	750/52	400/28	300/21	250/17			
FC563	0	2						1250/86		1100/76	1000/69	1000/69	750/52	500/34		
2808	0	2						2750/190	2500/172	1750/121	1500/103	1125/78	800/55			
FC211	0	1			2750/190		2250/155	2000/138		1250/86	1000/69					
FC465	0	2		3000/207	3000/207	3000/207	2500/172	2000/138	1500/103	1200/83	1000/69	625/43				
2807	0	2		3000/207	3000/207	3000/207	2500/172	2000/138	1500/103	1200/83	1000/69	625/43				
FC807	0	2			3000/207	3000/207	2500/172	2000/138	1500/103	1200/83	1000/69					
FC300	0	4			3000/207	3000/207	2250/155	2000/138	1750/121	1500/103	800/55	625/43	500/34	300/21	300/21	
FC611	0	6			3000/207		2250/155	2000/138		1250/86	1000/69	625/43	500/34	375/26		
1503	0	1			3000/207	3000/207	2250/155	2000/138	1750/121	1500/103	800/55	625/43	500/34	350/24	350/24	
2651	0	1			3000/207	3000/207	2250/155	2000/138	1750/121	1500/103	800/55	625/43	500/34	350/24	350/24	
303	0	1			3000/207	3000/207	2000/138	2000/138	1750/121	1500/103						
FC639/ FC839B	0	1			3000/207		3000/207	3000/207	3000/207	3000/207	3000/207					

† Pressure rating with reusable style fittings.

‡ Pressure rating with Global crimp style fittings.

§ 10,000 psi for static jack hose applications. See hose page for details.

¥ 10,000 psi for water blast applications. See hose page for details.

* See hose page for dash sizes not listed.

†† 50 psi max with band clamp style fittings.

Hose Dash Size to Maximum Operating Pressure

Pressures expressed in psi/bar.

This table is intended as a guide in the selection of hose by maximum operating pressure. It is not a guarantee. Final selection is further dependent on fluid and ambient temperature, concentration of fluid, intermittent or continuous exposure, etc.

For further details on a specific hose see the respective catalog pages or contact Eaton Corporation at 14615 Lone Oak Road, Eden Prairie, MN 55344 USA 952/937-9800.

HOSE TO FITTING PAGE REFERENCE CHART

Hose Part Number	Page	Tube	Hose -02	-03	-04	-05	-06	-08	-10	-12	-16	-20	-24	-32	-40	-48
GH681	0	1			3000/207		3000/207	3000/207								
FC194	0	4			3250/224		3000/207	2500/172	2000/138	1750/121	1250/86	900/62				
GH194	0	4			3250/224		3000/207	2500/172	2000/138	1800/124	1300/90	900/62				
GH663	0	1			3250/224		3000/207	2500/172		1800/124	1300/90	950/66	725/50	580/40		
					2750/190†		2250/155†	2000/138†		1250/86†	1000/69†					
2681	0	1		4000/276	3250/224	3250/224	3000/207	2500/172	2000/138	1800/124	1300/90	900/62	700/48	600		
GH493	0	1					4000/276	4000/276	4000/276	4000/276	4000/276	3000/207	2500/172	2500/172		
FC323	0	4								3000/207	3000/207	3000/207	3000/207	3000/207		
FC324	0	4						4000/276		4000/276	4000/276					
FC469	0	2						4000/276	4000/276	3500/241						
FC849/ FC849B	0	0			4000/276		4000/276	4000/276	4000/276	4000/276						
FC212	0	1			5000/345		4000/276	3500/241		2250/155	2000/138	1625/112	1250/86	1125/78		
FC310	0	1			5000/345		4000/276	3500/241	2750/190	2250/155	2000/138	1625/112				
FC693	0	6			5000/345		4000/276	3500/241								
GH120	0	1			5000/345		4000/276	3500/241	2750/190	2250/155	2000/138	1625/112	1250/86	1125/78		
FC510	0	4			5000/345		4000/276	3500/241	2750/190	2250/155	2000/138	1625/112				
FC325	0	4								5000/345	5000/345					
FC273/ FC273B	0	1								5000/345	5000/345	5000/345	5000/345	5000/345		
FC659	0	1					4000/276	4000/276	4000/276	4000/276	4000/276	3000/207	2500/172	2500/172		
FC136	0	1					5500/379§ 4000/276‡	5000/345 4000/276‡	5000/345 4000/276‡	4000/276	4000/276	3000/207	2500/172	2500/172		
FC636	0	6								4000/276	4000/276	3000/207	2500/172			
FC735	0	1			5000/345		5000/345	4250/293	3625/250	3125/216	2500/172	2250/155				
FC736	0	1					5500/379	5000/345	5000/345	4000/276	4000/276	3000/207	2500/172	2500/172		
							4000/276‡	4000/276‡	4000/276‡							
2766	0	1			5000/345		4000/276	3500/241		2250/155	2000/138	1625/112	1250/86	1000/69		
2781	0	1			5000/345		4000/276	3500/241	3250/224	3000/207	2000/138	1625/112	1750/121	1250/86		
					5750/397‡		5000/345‡	4250/293‡	3625/250‡	3125/216‡	2500/172‡	2250/155‡	1800/124‡	1500/103‡		
FC195	0	4			5000/345		4000/276	3500/241	2750/190	3000/207	2000/138	1625/112	1750/121	1250/86		
					5750/397‡		5000/345‡	4250/293‡	3250/224‡	3125/216‡	2500/172‡	2250/155‡	1800/124‡	1500/103‡		
GH195	0	4			5750/397		5000/345	4250/293	3250/224	3000/207	2500/172	2250/155	1750/121	1500/103		
GH781	0	1			5750/400		5000/345	4250/293	3625/250	3125/216	2500/172	2250/155	1800/124	1300/90		
GH793	0	1			5750/397		5000/345	4250/293	3625/250	3125/216	2500/172	2250/155	1800/124	1300/90		
					5000/345†		4000/276‡	3500/241‡	2750/190‡	2250/155‡	2000/138‡					
GH506	0	1								6090/420	5510/380	5075/350	4250/293	3625/250		
FC254	0	1						7500/517¥		6250/431	5000/345	4000/276	3000/207	3000/207		
GH466	0	1										5510/380				
FC606/ FC606B	0	1										6000/414	6000/414	6000/414		
FC579***	0	1			10000/690§		10000/690§									

† Pressure rating with reusable style fittings.

‡ Pressure rating with Global crimp style fittings.

§ 10,000 psi for static jack hose applications. See hose page for details.

¥ 10,000 psi for water blast applications. See hose page for details.

* See hose page for dash sizes not listed.

†† 50 psi max with band clamp style fittings.

SPECIALTY & TRUCK HOSE

LOW & MEDIUM PRESSURE HOSE

HIGH PRESSURE HOSE

HOSE FITTINGS

ADAPTERS & TUBE FITTINGS

ACCESSORIES & ASSEMBLY INSTRUCTIONS

HOSE ASSEMBLY EQUIPMENT

APPENDICES

Agency Listings

Government Agencies

- DOT/FMVSS** – US Department of Transportation, Federal Motor Vehicle Safety Standard
- FDA** – US Food and Drug Administration (tubes only)
- MIL/DOD** – US Military Specification, Dept. of Defense
- MSHA** – US Mine Safety and Health Administration
- USCG/MMT** – US Coast Guard, Merchant Marine Technical (SAE J1942 has replaced USCG approval)
- DNV** – Det Norske (Norwegian) Veritas
- CGA** – Canadian Gas Association

The listings below are intended only as guides in identifying which Aeroquip hoses comply with requirements of various agencies. For current and complete information, contact Eaton.

Industry Agencies

- AAR** – American Association of Railroads
- DIN** – Deutsche (German) Industrial Norme (Replaced by EN)
- EN** – Committee for European Normalization
- ABS** – American Bureau of Shipping
- SAE** – Society of Automotive Engineers
- UL** – Underwriters Laboratories
- ISO** – International Standards Organization
- ★ = Approved details available from Eaton

*Listing may vary by hose style and size, some hoses may require firesleeve or special procedures depending on specific applications, contact Eaton for details.

Hose Part Number Page	GOVERNMENT							INDUSTRY						
	DOT/FMVSS	CGA	DNV	FDA*	MIL/DOD	MSHA	USCG/MMT*	ISO	EN	DIN	AAR	ABS	SAE	UL
1503 0	106 Type All		★				★						100R5, J1402	
1531 0											M618			
1531A 0											M618			
2550 0	106 Type All						★						J1402	
2554														
2556 0			★			★								
2565 0					MIL-H-13444 Type I									
2570 0	106 Type All						★						J1402	
2580 0					MIL-H-24136/3	★	★							
2583 0			★			★			EN 854 Type R3				100R3	
2651 0			★			★	★					★		
2661 0						★	★					★+	100R4	
2681 0			★			★	★	1436 Type 1ST	EN 853 Type 1ST	20 022 Type 1ST			100R1A	
2781 0			★			★	★	1436 Type 1ST	EN 853 Type 2ST	20 022 Type 2ST			100R2A	
2807 0			★				★					★	100R14A	
2808 0							★					★		
302A 0					MIL-DTL-8794									
303 0					MIL-DTL-8794									
CR170 0		Type III												
FC136 0			★			★	★	3862 Type R12	EN 856 Type R12			★	100R12	
FC194 0			★+			★	★	1436 Type 1ST	EN 856 Type 1ST	20 022 Type 1ST			100R1A, J1019	
FC195 0						★	★	1436 Type 2ST	EN 856 Type 1ST	20 022 Type 1ST			100R2A	
FC211 0						★	★	1436 Type R1AT					100R2AT	
FC212 0						★	★	1436 Type R1AT					100R2AT	
FC234 0			★			★	★					★	J1527 Type A1	
FC252 0														

★ = Approved details available from Eaton
 ‡ = In size -04 meets ISO 1436 Type R2AT
 + = Firesleeve required. Contact Eaton for details.
 † = Does not meet in -04 size

Agency Listings

Hose Part Number Page	GOVERNMENT							INDUSTRY							SPECIALTY & TRUCK HOSE
	DOT/FMVSS	CGA	DNV	FDA*	MIL/DOD	MSHA	USCG/MMT*	ISO	EN	DIN	AAR	ABS	SAE	UL	
FC254	0			★			★	★				★	100R11		
FC273	0			★			★	★	3862 Type R13	EN 856 Type R13		★	100R13		
FC273B	0								3862 Type R13	EN 856 Type R13			100R13		
FC300	0	106 Type All		★				★				★	100R5, J1019, J1402		
FC310	0						★	★		EN 857 Type 1SC		★	100R16		
FC321	0													UL21	
FC323	0						★	★				★	100R11, 100R12		
FC324	0							★	★	EN 856 Type R12		★	100R12		
FC325	0						★	★		EN 856 Type R13			100R13		
FC332	0											★+			
FC350	0	106 Type All		★+				★	★			★	J1402		
FC352	0												20R1		
FC355	0	106 Type All										★	J1402		
FC363	0				★			★							
FC364	0				★										
FC465	0												100R14B		
FC466	0									EN 854 Type R6			100R6		
FC469	0														
FC498	0						★			EN 854 Type R6			100R6		
FC510	0						★	★		EN 857 Type 1SC			100R2AT		
FC555	0														
FC558	0												J2064 Type B Class 1		
FC563	0														
FC579	0						★								
FC598	0												100R6		
FC606	0						★			3862 Type R15		★	100R15		
FC606B	0									3862 Type R15			100R15		
FC611	0														
FC619	0				★		★					★+	100R4		
FC629	0	106 Type All											J1402		
FC636	0														
FC639	0						★					★	100R17		
FC647	0														
FC650	0														

★ = Approved details available from Eaton.
 + Firesleeve required. Contact Eaton for details.
 †Applies only to hose that has suffered no damage, has been properly assembled with hose guards and tested to required proof test pressure.

SPECIALTY & TRUCK HOSE

LOW & MEDIUM PRESSURE HOSE

HIGH PRESSURE HOSE

HOSE FITTINGS

ADAPTERS & TUBE FITTINGS

ACCESSORIES & ASSEMBLY INSTRUCTIONS

HOSE ASSEMBLY EQUIPMENT

APPENDICES

Agency Listings

SPECIALTY &
TRUCK HOSE

LOW & MEDIUM
PRESSURE HOSE

HIGH PRESSURE HOSE

HOSE FITTINGS

ADAPTERS &
TUBE FITTINGS

ACCESSORIES &
ASSEMBLY INSTRUCTIONS

HOSE ASSEMBLY
EQUIPMENT

APPENDICES

Hose Part Number Page	GOVERNMENT							INDUSTRY						
	DOT/FMVSS	CGA	DNV	FDA*	MIL/DOD	MSHA	USCG/MMT*	ISO	EN	DIN	AAR	ABS	SAE	UL
FC659 0			★			★	★		E3862 Type R12	EN 856 Type R12		★	100R12	
FC693 0														
FC699 0														
FC735 0									1436 Type 2SN§	20 022 Type 2SN	‡		100R16	
FC736 0									3862 Type R12	EN856 Type R12			100R12	
FC807 0													100R14A	
FC829 0	106 Type All											J1420		
FC839B 0													100R17	
FC849 0						★	★					★		
FC849B 0														
GH120 0						★							100R16	
GH194 0			★+			★		1436 Type 1SN	EN 853 Type 1SN	20 022 Type 1SN		★	100R1AT	
GH195 0						★	★	1436 Type 2SN	EN 853 Type 2SN	20 022 Type 2SN		★	100R2AT	
GH466 0						★								
GH493 0			★			★	★	3862 Type R12	EN 853 Type R12			★	100R12	
GH506 0			★			★		3862 Type 4SH	EN856 Type 4SH	20 023 Type T2				
GH663 0			★			★	★††	1436 Type 1SN	EN 853 Type 1SN	20 022 Type 1SN		★	100R1AT	
GH681 0						★				DIN20022 Type 1				
GH781 0			★			★	★		EN 853 Type 2SC			★	100R16	
GH793 0			★			★	★	1436 Type 2SN	EN 853 Type 2SN	20 022 Type 2SN		★	100R2AT	

★ = Approved details available from Eaton.
 + Firesleeve required. Contact Eaton for details.
 †† = -4 thru -16 only

Fluid Compatibility

Fluid compatibility

This chart indicates the suitability of various elastomers and metals for use with fluids to be conveyed. It is intended as a guide only and is not a guarantee. Final selection of the proper hose style, seal, or material of metal components is further dependent on many factors including pressure, fluid and ambient temperature, concentration, duration of exposure, etc.

How to use the chart

- The chart has separate sections for rating elastomers for use as hose inner tubes and as seals. Ratings for a given elastomer may not always be the same in both sections.
- Both the elastomer and the metal must be considered when determining suitability of a combination for a hose assembly, adapter with o-ring, swivel joint or coupling.
- Locate the fluid to be conveyed and determine the suitability of the elastomeric and metal components according to the resistance ratings shown for each.
- Specific hose part numbers can be found under the inner tube material groupings in the Hose Tube Identification Chart below.
- Dimensional and operating specifications for each hose can be found on the catalog pages shown with each hose part number.
- Information on o-rings and seal options for swivel joints and couplings, and how to specify them, are shown in the respective sections of this catalog.

7. For further details on the products shown in this catalog, and their applications, contact:

Eaton

14615 Lone Oak Road
Eden Prairie, MN 55344
USA
952/937-9800;
Fax: 952/974-7722
www.hydraulics.eaton.com

Resistance key rating

- E = Excellent – Fluid has little or no effect.
G = Good – Fluid has minor to moderate effect.
C = Conditional – Service conditions should be described to Eaton Aeroquip for determination of suitability for application.
U = UNSATISFACTORY

The differences between ratings “E” and “G” are relative. Both indicate satisfactory service. Where there is a choice, the materials rated “E” may be expected to give better or longer service than those rated “G”.

NOTE: Special precautions are necessary in gaseous applications due to the potential volume of gaseous fluid in the system. Unless the cover is perforated, hose styles with rubber or thermoplastic covers are not suitable for gases above 250 psi. Hose styles with perforated covers are so noted in their construction descriptions.

WARNING  Compatibility of hose fittings with conveyed fluid is an essential factor in avoiding chemical reactions that may result in release of fluids or failure of the connection with the potential of causing severe personal injury or property damage.

Hose tube identification chart

1. Nitrile

302A (p.26)	FC136 (p.52)	FC619 (p.34)	GH120 (p.45)
303 (p.26)	FC211 (p.38)	FC639/ (p.42)	GH466 (p.55)
1503 (p.26)	FC212 (p.44)	FC606 (p.56)	GH493 (p.51)
2556 (p.34)	FC254 (p.53)	FC647 (p.33)	GH506 (p.55)
2565 (p.34)	FC273/ (p.54)	FC659 (p.52)	GH663 (p.39)
2580 (p.37)	FC273B (p.54)	FC735 (p.46)	GH681 (p.42)
2583 (p.37)	FC310 (p.41)	FC736 (p.53)	GH781 (p.47)
2651 (p.25)	FC466 (p.35)	FC849/ (p.43)	GH793 (p.48)
2681 (p.38)	FC579 (p.57)	FC849B (p.44)	
2781 (p.47)		FC849B (p.43)	

2. PTFE

2807 (p.28)	FC363 (p.31)	FC465 (p.29)	FC563 (p.32)
2808 (p.30)	FC364 (p.31)	FC469 (p.30)	FC807 (p.29)

3. Thermoplastic Elastomer

4. AQP

2661 (p.35)	FC323 (p.50)	FC350 (p.23)	FC598 (p.36)
FC194 (p.40)	FC324 (p.50)	FC355 (p.23)	FC650 (p.24)
FC195 (p.49)	FC325 (p.51)	FC498 (p.36)	FC699 (p.24)
FC234 (p.25)	FC332 (p.33)	FC510 (p.41)	GH194 (p.39)
FC300 (p.27)		FC598 (p.36)	GH195 (p.48)

5. Special Application Hose (Not Included in Fluid Chart)

FC234	FC650	Fuel	(pp.25, 24)	
CR170	FC321	LPG	(pp.27, 28)	
1531	1531A	Railroad Air Brake	(p.22)	
FC252	FC352	FC629	FC829	Silicone (p.20)
2550	2554	2570	FC350	Truck Air Brake (pp.21-23)

6. EPDM Rubber

FC611 (p.40)	FC636 (p.49)	FC693 (p.46)
--------------	--------------	--------------

SEAL ELASTOMER DATA

Seal Elastomer	Application Specification	Max. Operating Temperature Range
Buna-N†	none	-40°C to +121°C [-40°F to +250°F]
Neoprene	none	-54°C to +100°C [-65°F to +212°F]
EPR (Ethylene Propylene Rubber)/EPDM	none	-54°C to +149°C [-65°F to +300°F]
Viton*	MIL-R-25897	-29°C to +204°C [-15°F to +400°F]

†Buna-N temperature range -65°F to +225°F. Also per MIL-R-6855.

*Viton is a trademark of E.I. DuPont.

Fluid Compatibility

E = EXCELLENT
G = GOOD
C = CONDITIONAL
U = UNSATISFACTORY

E = EXCELLENT
G = GOOD
C = CONDITIONAL
U = UNSATISFACTORY

SPECIALTY & TRUCK HOSE
LOW & MEDIUM PRESSURE HOSE
HIGH PRESSURE HOSE
HOSE FITTINGS
ADAPTERS & TUBE FITTINGS
ACCESSORIES & ASSEMBLY INSTRUCTIONS
HOSE ASSEMBLY EQUIPMENT
APPENDICES

FLUID	Thermoplastic Elastomer						Special Application Hose						Thermoplastic Elastomer						Special Application Hose																																															
	Nitrile		PTFE		AQP		EPDM		Buna-N		Neoprene		EPR		Viton*		Urethane		Hytrek		Steel		Brass		Stainless Steel		Aluminum		Monel																																					
	1	2	3	4	5	6	1	2	3	4	5	6	1	2	3	4	5	6	1	2	3	4	5	6	1	2	3	4	5	6	1	2	3	4	5	6																														
Acetaldehyde	U	E	C	C	U	G	U	C	C	U	U	G	U	C	C	U	U	G	U	C	C	U	U	G	U	C	C	U	U	G	U	C	C	U	U	G	U	C	C	U	U	G	U	C	C	U	U	G																		
Acetic Acid, 10%	U	E	C	C	U	G	U	C	C	U	U	G	U	C	C	U	U	G	U	C	C	U	U	G	U	C	C	U	U	G	U	C	C	U	U	G	U	C	C	U	U	G	U	C	C	U	U	G	U	C	C	U	U	G												
Acetic Acid, Glacial	U	E	C	C	U	G	U	C	C	U	U	G	U	C	C	U	U	G	U	C	C	U	U	G	U	C	C	U	U	G	U	C	C	U	U	G	U	C	C	U	U	G	U	C	C	U	U	G	U	C	C	U	U	G	U	C	C	U	U	G						
Acetone	U	E	C	C	U	G	U	C	C	U	U	G	U	C	C	U	U	G	U	C	C	U	U	G	U	C	C	U	U	G	U	C	C	U	U	G	U	C	C	U	U	G	U	C	C	U	U	G	U	C	C	U	U	G	U	C	C	U	U	G	U	C	C	U	U	G
Acetophenone	U	E	C	C	U	G	U	C	C	U	U	G	U	C	C	U	U	G	U	C	C	U	U	G	U	C	C	U	U	G	U	C	C	U	U	G	U	C	C	U	U	G	U	C	C	U	U	G	U	C	C	U	U	G	U	C	C	U	U	G	U	C	C	U	U	G
Acetyl Acetone	U	E	C	C	U	G	U	C	C	U	U	G	U	C	C	U	U	G	U	C	C	U	U	G	U	C	C	U	U	G	U	C	C	U	U	G	U	C	C	U	U	G	U	C	C	U	U	G	U	C	C	U	U	G	U	C	C	U	U	G	U	C	C	U	U	G
Acetyl Chloride	U	E	C	C	U	G	U	C	C	U	U	G	U	C	C	U	U	G	U	C	C	U	U	G	U	C	C	U	U	G	U	C	C	U	U	G	U	C	C	U	U	G	U	C	C	U	U	G	U	C	C	U	U	G	U	C	C	U	U	G	U	C	C	U	U	G
Acetylene ¹	G	E	C	C	U	G	U	C	C	U	U	G	U	C	C	U	U	G	U	C	C	U	U	G	U	C	C	U	U	G	U	C	C	U	U	G	U	C	C	U	U	G	U	C	C	U	U	G	U	C	C	U	U	G	U	C	C	U	U	G	U	C	C	U	U	G
Air, Hot (Up to +160°F) ¹	E	E	C	C	U	G	U	C	C	U	U	G	U	C	C	U	U	G	U	C	C	U	U	G	U	C	C	U	U	G	U	C	C	U	U	G	U	C	C	U	U	G	U	C	C	U	U	G	U	C	C	U	U	G	U	C	C	U	U	G	U	C	C	U	U	G
Air, Hot (161°F – 200°F) ¹	C	E	C	C	U	G	U	C	C	U	U	G	U	C	C	U	U	G	U	C	C	U	U	G	U	C	C	U	U	G	U	C	C	U	U	G	U	C	C	U	U	G	U	C	C	U	U	G	U	C	C	U	U	G	U	C	C	U	U	G	U	C	C	U	U	G
Air, Hot (201°F – 300°F) ¹	U	E	C	C	U	G	U	C	C	U	U	G	U	C	C	U	U	G	U	C	C	U	U	G	U	C	C	U	U	G	U	C	C	U	U	G	U	C	C	U	U	G	U	C	C	U	U	G	U	C	C	U	U	G	U	C	C	U	U	G	U	C	C	U	U	G
Air Wet, below 160°F ¹	E	E	C	C	U	G	U	C	C	U	U	G	U	C	C	U	U	G	U	C	C	U	U	G	U	C	C	U	U	G	U	C	C	U	U	G	U	C	C	U	U	G	U	C	C	U	U	G	U	C	C	U	U	G	U	C	C	U	U	G	U	C	C	U	U	G
Aluminum Chloride, 10% aq	E	E	C	C	U	G	U	C	C	U	U	G	U	C	C	U	U	G	U	C	C	U	U	G	U	C	C	U	U	G	U	C	C	U	U	G	U	C	C	U	U	G	U	C	C	U	U	G	U	C	C	U	U	G	U	C	C	U	U	G	U	C	C	U	U	G
Aluminum Fluoride, 10% aq	E	E	C	C	U	G	U	C	C	U	U	G	U	C	C	U	U	G	U	C	C	U	U	G	U	C	C	U	U	G	U	C	C	U	U	G	U	C	C	U	U	G	U	C	C	U	U	G	U	C	C	U	U	G	U	C	C	U	U	G	U	C	C	U	U	G
Aluminum Nitrate, 10% aq	E	E	C	C	U	G	U	C	C	U	U	G	U	C	C	U	U	G	U	C	C	U	U	G	U	C	C	U	U	G	U	C	C	U	U	G	U	C	C	U	U	G	U	C	C	U	U	G	U	C	C	U	U	G	U	C	C	U	U	G	U	C	C	U	U	G
Aluminum Sulfate, 10% aq	E	E	C	C	U	G	U	C	C	U	U	G	U	C	C	U	U	G	U	C	C	U	U	G	U	C	C	U	U	G	U	C	C	U	U	G	U	C	C	U	U	G	U	C	C	U	U	G	U	C	C	U	U	G	U	C	C	U	U	G	U	C	C	U	U	G
Alums, 10% aq	E	E	C	C	U	G	U	C	C	U	U	G	U	C	C	U	U	G	U	C	C	U	U	G	U	C	C	U	U	G	U	C	C	U	U	G	U	C	C	U	U	G	U	C	C	U	U	G	U	C	C	U	U	G	U	C	C	U	U	G	U	C	C	U	U	G
Ammonia, Cold	E	E	C	C	U	G	U	C	C	U	U	G	U	C	C	U	U	G	U	C	C	U	U	G	U	C	C	U	U	G	U	C	C	U	U	G	U	C	C	U	U	G	U	C	C	U	U	G	U	C	C	U	U	G	U	C	C	U	U	G	U	C	C	U	U	G
Ammonia, Hot	U	E	C	C	U	G	U	C	C	U	U	G	U	C	C	U	U	G	U	C	C	U	U	G	U	C	C	U	U	G	U	C	C	U	U	G	U	C	C	U	U	G	U	C	C	U	U	G	U	C	C	U	U	G	U	C	C	U	U	G						
Ammonia, Anhydrous	C	E	C	C	U	G	U	C	C	U	U	G	U	C	C	U	U	G	U	C	C	U	U	G	U	C	C	U	U	G	U	C	C	U	U	G	U	C	C	U	U	G	U	C	C	U	U	G	U	C	C	U	U	G	U	C	C	U	U	G						
Ammonia, Aqueous	G	E	C	C	U	G	U	C	C	U	U	G	U	C	C	U	U	G	U	C	C	U	U	G	U	C	C	U	U	G	U	C	C	U	U	G	U	C	C	U	U	G	U	C	C	U	U	G	U	C	C	U	U	G	U	C	C	U	U	G						
Ammonium Carbonate, 10% aq	U	E	C	C	U	G	U	C	C	U	U	G	U	C	C	U	U	G	U	C	C	U	U	G	U	C	C	U	U	G	U	C	C	U	U	G	U	C	C	U	U	G	U	C	C	U	U	G	U	C	C	U	U	G	U	C	C	U	U	G						
Ammonium Chloride, 10% aq	E	E	C	C	U	G	U	C	C	U	U	G	U	C	C	U	U	G	U	C	C	U	U	G	U	C	C	U	U	G	U	C	C	U	U	G	U	C	C	U	U	G	U	C	C	U	U	G	U	C	C	U	U	G	U	C	C	U	U	G						
Ammonium Hydroxide, 10% aq	U	E	C	C	U	G	U	C	C	U	U	G	U	C	C	U	U	G	U	C	C	U	U	G	U	C	C	U	U	G	U	C	C	U	U	G	U	C	C	U	U	G	U	C	C	U	U	G	U	C	C	U	U	G	U	C	C	U	U	G						
Ammonium Nitrate, 10% aq	E	E	C	C	U	G	U	C	C	U	U	G	U	C	C	U	U	G	U	C	C	U	U	G	U	C	C	U	U	G	U	C	C	U	U	G	U	C	C	U	U	G	U	C	C	U	U	G	U	C	C	U	U	G	U	C	C	U	U	G						
Ammonium Phosphate, 10% aq	E	E	C	C	U	G	U	C	C	U	U	G	U	C	C	U	U	G	U	C	C	U	U	G	U	C	C	U	U	G	U	C	C	U	U	G	U	C	C	U	U	G	U	C	C	U	U	G	U	C	C	U	U	G	U	C	C	U	U	G						
Ammonium Sulfate/Sulfide, 10% aq	E	E	C	C	U	G	U	C	C	U	U	G	U	C	C	U	U	G	U	C	C	U	U	G	U	C	C	U	U	G	U	C	C	U	U	G	U	C	C	U	U	G	U	C	C	U	U	G	U	C	C	U	U	G	U	C	C	U	U	G						
Amyl Acetate	U	E	C	C	U	G	U	C	C	U	U	G	U	C	C	U	U	G	U	C	C	U	U	G	U	C	C	U	U	G	U	C	C	U	U	G	U	C	C	U	U	G	U	C	C	U	U	G	U	C	C	U	U	G	U	C	C	U	U	G						
Amyl Alcohol	G	E	C	C	U	G	U	C	C	U	U	G	U	C	C	U	U	G	U	C	C	U	U	G	U	C	C	U	U	G	U	C	C	U	U	G	U	C	C	U	U	G	U	C	C	U	U	G	U	C	C	U	U	G	U	C	C	U	U	G						
Aniline, Aniline Oil	U	E	C	C	U	G	U	C	C	U	U	G	U	C	C	U	U	G	U	C	C	U	U	G	U	C	C	U	U	G	U	C	C	U	U	G	U	C	C	U	U	G	U	C	C	U	U	G	U	C	C	U	U	G												
Aniline Dyes	U	E	C	C	U	G	U	C	C	U	U	G	U	C	C	U	U	G	U	C	C	U	U	G	U	C	C	U	U	G	U	C	C	U	U	G	U	C	C	U	U	G	U	C	C	U	U	G	U	C	C	U	U	G												
Asphalt, < 200°F	C	E	C	C	U	G	U	C	C																																																									

Fluid Compatibility

E = EXCELLENT
 G = GOOD
 C = CONDITIONAL
 U = UNSATISFACTORY

FLUID	Thermoplastic Elastomer						Special Application Hose						METAL					
	Nitrile	PTFE	AQP	EPDM	Buna-N	Neoprene	EPR	Viton*	Urethane	Hytre	Steel	Brass	Stainless Steel	Aluminum	Monel			
Heptane	E	E	E	C	U	E	G	U	E	G	E	F	F	F	F			
Hexaldehyde	U	E	F	U	E	U	G	U	U	U	G	F	F	F	F			
Hexane	E	F	E	E	U	F	G	U	E	G	G	E	F	F	F			
Hydraulic Oils ²																		
Ester Blend	C	E	C	G	E	E	U	U	E	U	E	E	E	E	E			
Phos. Ester/Petroleum Blend	U	E	F	C	U	U	U	U	C	U	G	F	F	F	F			
Silicone Oils	E	F	E	E	E	E	F	E	E	E	E	F	F	F	F			
Straight Petroleum Base	E	F	E	E	U	F	G	U	E	E	E	F	F	F	F			
Straight Phosphate Ester	U	E	F	C	U	E	U	U	G	C	U	G	F	F	F			
Water Glycol	E	F	C	C	E	F	E	F	E	E	C	C	E	F	E			
Water Petroleum Emulsion	E	F	C	G	U	E	F	G	U	E	C	C	C	E	F			
Hydrobromic Acid	U	E	U	E	G	U	U	E	E	U	U	E	E	E	U			
Hydrochloric Acid, Cold	U	E	U	U	G	U	U	G	E	U	U	U	U	U	U			
Hydrocyanic Acid	C	E	U	U	E	C	C	E	E	U	E	F	G	E	G			
Hydrofluoric Acid	U	E	U	U	U	U	C	U	U	U	U	U	U	U	C			
Hydrofluorosilic Acid	E	F	U	G	G	G	G	E	F	U	U	U	U	U	U			
Hydrogen ¹	G	C	C	G	E	E	E	E	E	E	E	E	E	E	E			
Hydrogen Peroxide	C	E	G	G	G	G	G	E	G	G	U	U	G	F	U			
Hydrogen Sulfide, Dry	U	C	C	U	E	U	G	E	U	U	G	G	G	G	G			
Isocyanate	U	E	U	U	U	U	G	E	U	U	G	U	G	U	U			
Iso Octane	G	E	F	G	U	E	G	U	E	G	E	F	E	F	E			
Isopropyl Acetate	U	E	F	C	U	U	G	U	U	C	E	U	E	E	E			
Isopropyl Alcohol	G	E	C	G	E	G	G	E	E	U	C	E	F	F	G			
Isopropyl Ether	G	E	U	C	U	G	U	U	U	C	U	G	G	G	U			
JP-4, JP-5	E	F	E	G	E	U	F	U	U	E	U	G	E	F	F			
Kerosene	G	E	G	E	U	E	U	U	E	U	G	E	F	F	F			
Lacquer/Lacquer Solvents	U	E	U	U	U	U	U	U	U	G	U	E	E	E	E			
Lime Sulfur	U	E	C	U	E	U	E	E	E	C	C	G	U	G	U			
Linseed Oil	E	E	G	G	U	E	G	U	E	G	G	E	E	E	E			
LPG ¹	LPG Approved Hose Only						E						E					
Lubricating Oils ²	See Hydraulic Oils						See Hydraulic Oils						See Hydraulic Oils					
Magnesium Chloride, 10% aq	E	E	C	E	E	E	E	E	C	C	E	C	C	G	G			
Magnesium Hydroxide, 10% aq	G	E	C	G	E	G	G	E	E	C	C	E	F	E	G			
Magnesium Sulfate, 10% aq	E	E	C	E	E	E	E	E	C	C	E	F	E	E	E			
Maleic Acid	U	E	C	C	G	U	U	U	E	C	C	E	G	G	G			
Maleic Anhydride	U	E	C	U	C	U	U	U	E	C	C	G	U	F	G			
Malic Acid	G	E	U	G	U	G	U	G	U	U	U	U	E	G	E			
Mercuric Chloride	G	E	F	E	G	E	F	E	E	E	U	U	U	U	U			
Mercury	E	E	E	E	E	E	E	E	E	E	E	U	U	U	G			
Methanol	E	E	C	E	E	G	G	E	U	C	C	G	G	E	C			
Methyl Bromide	C	E	U	U	U	G	U	U	E	U	U	E	F	G	U			
Methyl Chloride	U	E	U	U	U	U	U	U	E	U	U	E	E	E	U			
Methyl Butyl Ketone	U	E	U	U	E	U	U	U	E	C	C	E	F	E	E			
Methyl Ethyl Ketone	U	E	U	U	E	U	U	U	U	G	G	G	G	G	G			
Methylene Chloride	U	E	U	U	U	U	U	G	U	U	G	G	G	G	G			
Methyl Isobutyl Ketone	U	E	U	U	E	U	U	U	U	U	G	G	G	G	G			
Methyl Isopropyl Ketone	U	E	U	C	E	U	U	U	U	U	G	G	G	G	G			
Methyl Salicylate	U	E	U	U	C	U	U	U	C	U	U	E	G	G	E			
MIL-L-2104	E	E	E	E	U	E	G	U	E	E	E	E	E	E	E			
MIL-H-5606	E	E	E	E	U	E	G	U	E	E	E	E	E	E	E			
MIL-H-6083	E	E	E	E	U	E	E	U	E	E	E	E	E	E	E			
MIL-L-7808	G	E	G	G	U	G	U	U	E	G	G	G	G	E	E			
MIL-L-23699	E	F	U	G	U	E	U	E	U	U	E	F	E	F	E			
MIL-H-46170	G	E	U	G	C	E	G	U	E	U	U	E	E	E	E			
MIL-H-83282	G	E	U	G	U	E	U	E	U	U	E	F	E	F	E			
Mineral Oils	E	E	G	E	U	E	G	U	E	G	G	E	F	E	E			
Naphtha	C	E	G	E	U	C	U	U	E	C	G	U	U	U	U			
Naphthalene	U	E	U	U	U	U	U	U	E	C	G	E	G	G	G			
Naphthenic Acid	U	E	U	U	U	C	U	U	E	U	U	E	G	E	G			

E = EXCELLENT
 G = GOOD
 C = CONDITIONAL
 U = UNSATISFACTORY

FLUID	Thermoplastic Elastomer						Special Application Hose						METAL					
	Nitrile	PTFE	AQP	EPDM	Buna-N	Neoprene	EPR	Viton*	Urethane	Hytre	Steel	Brass	Stainless Steel	Aluminum	Monel			
Natural Gas ¹	LPG Approved Hose Only						E						E					
Nickel Acetate, 10% aq	G	C	U	G	E	C	C	E	G	U	U	G	C	E	G			
Nickel Chloride, 10% aq	F	E	U	E	F	E	G	E	F	U	U	U	U	G	U			
Nickel Sulfate, 10% aq	E	E	U	E	E	E	E	E	E	U	U	U	U	G	U			
Nitric Acid, to 10%	U	E	U	U	G	U	U	U	E	U	C	U	U	E	U			
Nitric Acid, over 10%	U	C	U	U	U	U	U	G	U	U	U	U	U	E	C			
Nitrobenzene	U	E	U	U	U	U	U	G	U	U	U	U	U	F	G			
Nitrogen ¹	E	E	E	E	E	E	E	E	E	E	E	E	E	E	E			
Octyl Alcohol	C	E	E	U	U	E	E	E	E	E	E	E	E	E	E			
Oleic Acid	G	E	G	U	U	U	C	G	G	E	C	E	G	C	G			
(Fuming Sulfuric Acid)																		
Oleum	U	E	U	U	U	E	G	U	E	G	G	E	E	E	E			
Ortho-Dichlorobenzene	U	E	U	U	U	U	U	E	U	E	U	G	G	G	G			
Oxalic Acid, 10% aq	C	E	C	C	E	G	G	E	E	C	C	U	C	C	C			
Oxygen ¹	U	U	U	U	E	U	U	U	U	U	U	U	U	G	G			
Palmitic Acid	E	E	E	E	G	E	G	G	E	E	E	G	E	G	G			
Para-Dichlorobenzene	U	E	U	U	U	U	U	E	U	E	U	G	G	G	G			
Pentane ¹	LPG Approved Hose Only						E						E					
Perchloric Acid	U	E	U	U	G	E	G	G	E	U	U	U	U	U	U			
Perchloroethylene	U	E	U	U	U	U	U	E	U	U	U	C	G	G	E			
Petroleum Base Oils	G	E	E	E	U	E	G	U	E	E	E	E	E	E	E			
Phenol (Carbolic Acid)	U	E	U	U	U	U	G	E	U	U	E	E	E	E	G			
Phosphate Ester ²	U	E	C	U	E	U	U	G	C	U	G	E	E	E	E			
Phosphoric Acid 20%	U	E	U	U	E	U	U	G	E	U	U	U	U	C	E			
Phosphorous Trichloride	U	E	U	U	E	U	U	E	U	U	U	C	U	C	E			
Potassium Acetate, 10% aq	G	E	U	G	E	G	G	E	U	U	U	C	G	C	U			
Potassium Chloride, 10% aq	E	E	E	E	E	E	E	E	E	E	E	E	C	E	U			
Potassium Cyanide, 10% aq	E	E	E	G	E	E	E	E	E	E	E	C	U	G	U			
Potassium Dichromate, 10% aq	E	E	E	E	E	E	E	E	E	E	E	C	C	C	C			
Potassium Hydroxide, to 10%	G	E	C	C	E	G	G	E	G	C	C	G	G	G	U			
Potassium Hydroxide, over 10%	C	E	U	C	E	C	C	E	U	U	U	G	G	G	U			
Potassium Nitrate, 10% aq	E	E	E	E	E	E	E	E	E	E	E	G	G	E	U			
Potassium Sulfate, 10% aq	E	E	E	E	E	E	E	E	E	E	E	U	U	U	U			
Propane ¹ (Liquified)	LPG Approved Hose Only						C						E					
Propyl Acetate	U	E	U	U	G	U	G	U	U	U	U	E	E	E	E			
Propyl Alcohol	E	E	U	U	E	E	E	E	E	U	U	E	E	E	E			
Propylene	U	E	U	U	U	U	U	E	U	U	U	E	E	E	E			
Refrigerant R-12¹	E	U	G	G	C	G	E	C	E	E	E	E	E	E	E			
Refrigerant R-13 ¹	E	U	G	G	G	G	E	C	E	E	E	E	E	E	E			
Refrigerant R-22 ¹	U	C	U	U	E	U	E	C	U	U	U	E	E	E	E			
Refrigerant R-134a ¹	C	C	U	U	E	E	C	U	U	U	U	E	E	E	E			
Sewage	G	E	E	G	E	E	E	E	E	E	E	E	G	G	G			
Silicone Oils	G	E	E	G	E	E	E	E	E	E	E	E	E	E	E			
Soap (Water Solutions)	E	E	C	E	E	E	E	E	E	C	C	E	E	E	U			
Sodium Acetate, 10% aq	G	U	U	G	E	G	G	E	U	U	U	E	E	G	E			
Sodium Bicarbonate, 10% aq	E	E	E	E	E	E	E	E	E	E	E	E	G	G	E			
Sodium Borate, 10% aq	E	E	E	E	E	E	E	E	E	E	E	E	E	E	G			
Sodium Carbonate, 10% aq	E	E	E	E	E	E	E	E	E	E	E	E	G	E	U			
Sodium Chloride, 10% aq	E	E	E	E	E	E	E	E	E	E	E	E	U	C	C			
Sodium Cyanide, 10% aq	E	E	E	E	E	E	E	E	E	E	E	E	U	C	C			
Sodium Hydroxide, to 10%	C	E	G	C	E	U	G	E	E	G	G	C	G	C	U			
Sodium Hydroxide, over 10%	U	E	C	U	E	U	G	E	C	C	C	C	C	C	C			

This chart is intended for reference use only.
 The information in this chart pertains strictly to material compatibility and is not intended to be used as an application guide.
 For information on specific applications not included in this catalog, please contact Eaton Aeroquip.

*Viton is a E.I. DuPont trademark.
 Note 1 - Rubber-covered hose must be perforated to allow gas to escape.
 Note 2 - Due to the widely different additives in these fluids, testing should be done on the actual fluid being considered.

Fluid Compatibility

SPECIALTY & TRUCK HOSE

LOW & MEDIUM PRESSURE HOSE

HIGH PRESSURE HOSE

HOSE FITTINGS

ADAPTERS & TUBE FITTINGS

ACCESSORIES & ASSEMBLY INSTRUCTIONS

HOSE ASSEMBLY EQUIPMENT

APPENDICES

E = EXCELLENT
G = GOOD
C = CONDITIONAL
U = UNSATISFACTORY

FLUID	Thermoplastic Elastomer						Special Application Hose	SEALS	METAL						
	Nitrile	PTFE	AQP	EPDM	Buna-N	Neoprene									
	1	2	3	4	5	6									
Sodium Hypochlorite, 10% aq	C	E	C	G	G	C	C	C	C	C	U	U	U	U	C
Sodium Metaphosphate, 10% aq	E	E	E	E	E	E	E	E	E	E	E	G	G	U	G
Sodium Nitrate, 10% aq	G	E	E	G	E	G	G	E	-	E	E	E	C	E	E
Sodium Perborate, 10% aq	G	E	-	G	E	G	G	E	E	-	-	C	U	C	U
Sodium Peroxide, 10% aq	G	E	-	G	E	G	G	E	E	U	-	U	U	C	U
Sodium Phosphates, 10% aq	E	E	E	C	E	E	E	E	E	E	E	U	E	G	U
Sodium Silicate, 10% aq	E	E	E	G	E	E	E	E	E	E	E	E	E	E	E
Sodium Sulfate, 10% aq	E	E	E	G	E	E	E	E	E	E	E	C	G	G	G
Sodium Sulfide, 10% aq	E	E	E	G	E	E	E	E	E	E	E	C	U	C	U
Sodium Thiosulfate, 10% aq	G	E	E	G	E	G	E	E	E	E	E	U	U	C	G
Soy Bean Oil	E	E	G	C	U	E	G	U	E	G	G	E	E	E	E
Stannic Chloride	G	E	C	G	E	E	G	E	E	C	C	U	U	U	U
Steam ¹ (up to 388°F)	U	E	U	U	G	U	U	C	C	U	U	E	E	E	G
Stearic Acid	G	E	G	G	G	G	G	E	G	G	C	C	E	C	E
Stoddard Solvent	G	E	U	E	U	E	G	U	E	U	U	E	E	E	E
Styrene	U	E	U	U	U	U	U	G	U	U	E	E	E	E	E
Sulfur, Slurry	C	E	G	E	E	U	E	E	E	G	G	E	U	G	E
Sulfur Chloride, Wet	U	E	-	U	U	U	U	E	-	-	G	-	G	G	U
Sulfur Dioxide, Dry	U	E	U	U	E	U	G	E	U	U	E	G	G	E	G
Sulfur Trioxide	U	E	U	U	C	U	G	E	U	U	G	C	G	G	G
Sulfuric Acid, to 10%	U	E	U	U	E	U	G	U	E	C	C	U	G	C	-
Sulfuric Acid, over 10%	U	E	U	U	U	U	U	G	U	U	C	C	C	U	C
Sulfurous Acid	U	E	U	G	G	C	C	U	G	U	U	U	C	C	C
Tannic Acid	G	E	G	G	E	G	E	E	E	G	G	E	E	C	E
Tar (Bituminous)	G	E	G	G	U	G	U	U	E	G	G	E	G	E	E
Tartaric Acid	E	E	G	E	G	E	G	E	G	G	U	C	C	E	E
Tertiary Butyl Alcohol	G	E	G	E	G	G	G	E	G	G	G	G	G	G	G
Titanium Tetrachloride	U	E	-	U	U	C	U	U	E	-	-	E	U	G	U
Toluene (Toluol)	U	E	U	U	U	U	U	E	U	U	E	E	E	E	E
Trichlorethylene	U	E	U	U	U	U	U	E	U	U	E	E	G	E	E
Tricresyl Phosphate	U	E	U	U	U	U	E	G	U	U	E	-	C	-	G
Triethanolamine	G	E	U	G	E	E	U	E	U	U	U	E	U	E	E
Tung Oil	E	E	C	U	U	G	G	U	E	U	C	E	G	E	E
Turpentine	E	E	G	G	U	G	U	E	G	G	G	G	G	G	G
Varnish	C	E	G	G	U	G	U	E	G	G	E	G	E	E	E
Vinyl Chloride	U	E	U	U	U	U	U	E	U	U	E	U	C	E	E
Water (to +150°F)	E	E	E	C	E	E	E	E	E	E	E	C	G	E	E
Water (+151°F to +200°F)	C	E	U	U	E	E	E	E	E	U	U	C	G	E	G
Water (+201°F to +350°F)	U	E	U	U	E	U	G	G	U	U	C	G	E	G	E
Water Glycol	E	E	C	E	E	E	E	E	C	C	E	E	E	G	E
Water Petroleum Emulsion ²	E	E	C	C	U	E	G	U	E	C	C	C	E	E	G
Xylene	U	E	C	U	U	U	U	E	U	C	E	E	E	E	E
Zinc Chloride, 10% aq	E	E	E	E	E	E	E	E	E	E	E	U	U	C	G
Zinc Sulfate, 10% aq	E	E	-	E	E	E	E	E	-	-	U	C	G	C	G

This chart is intended for reference use only.
The information in this chart pertains strictly to material compatibility and is not intended to be used as an application guide.
For information on specific applications not included in this catalog, please contact Eaton Aeroquip.

*Viton is a E.I. DuPont trademark.
Note ¹ - Rubber-covered hose must be perforated to allow gas to escape.
Note ² - Due to the widely different additives in these fluids, testing should be done on the actual fluid being considered.

Hydraulic fluids & lubricating oils

The following is a representative list of fluids and manufacturers. The fluids are grouped under generic "family" heads and arranged alphabetically. For each generic "family" listing we have included maximum fluid temperature recommendations for the four hose classifications on page 349 (1 through 4). Two maximum fluid temperature ratings are listed under designations of "H" and "LP".

The "H" designation is for hydraulic service up to the maximum rated operating pressure of any particular hose in the classification. The "LP" designation is for low-pressure service such as lubricating oil systems or low-pressure hydraulic return lines.

The letter "U" in the box indicates unsatisfactory resistance to the fluid type.

Fluid temperature ratings are predicated on maximum allowable ambient temperatures as follows:

Classifications 1 and 3 (Synthetic Rubber and Thermoplastic Elastomer)

"H" fluid temp. ratings: +140°F ambient

"LP" fluid temp. ratings: +180°F ambient

Classification 2 (PTFE)

"H" fluid temp. ratings: +400°F ambient

"LP" fluid temp ratings: +400°F ambient

Classification 4 (AQP)

"H" fluid temp. ratings: +160°F ambient

"LP" fluid temp. ratings: +250°F ambient

(If "H" fluid temperature is +225°F or less, allowable ambient temperature may be increased to +200°F)

Ambient temperatures in excess of those recommended, in conjunction with maximum fluid temperatures, can materially shorten the service life of the hose.

CAUTION: The fluid manufacturer's recommended maximum operating temperature for any specific namebrand fluid should be scrupulously observed by the user. These recommended temperatures can vary widely between name brands of different fluid compositions, even though they fall into the same generic "family" of fluids.

Exceeding the manufacturer's recommended maximum temperature can result in fluid breakdown, producing by-products that are harmful to elastomeric products, as well as other materials in the system. If a manufacturer's recommended maximum temperature for his specific fluid is lower than that for the hose rating, it should take precedence over the hose rating for service usage.

Fluid Compatibility

STRAIGHT PETROLEUM-BASE

Maximum fluid temperature recommendation**

HOSE CLASSIFICATIONS (SEE P. 349)

	1	2	3	4
H	+200°F	+400°F	+200°F	+300°F
LP	+250°F	+450°F	+200°F	+300°F

Fluid Name

Aircraft Hydraulic Oil AA
 Ambrex Oils
 Arco A.T.F. Dexron
 Arco A.T.F. Type F
 Arco Fleet Motor
 Arco H.T.F. C-2 Fluid
 Arco H.T.C. 100 Fluid
 Arco 303 Fluid
 ATF Special
 Automatic Transmission Fluid (Dexron)
 Carnea Oils
 Citgo Amplex
 Citgo ATF, Type F
 Citgo ATF, Dexron
 Citgo Extra Duty Circulating Oils Mineral Oil (Heavy Duty) (R & O)
 Citgo Motor Oils
 Citgo Pacemaker Series Mineral Oil (R & O)
 Citgo Pacemaker T Series Mineral Oil (R & O)
 Citgo Pacemaker XD Series Mineral Oil (Heavy Duty) (R & O)
 Citgo Sentry
 Citgo Tractor Hydraulic Fluid
 Conoco 303 Fluid
 Custom Motor Oil
 Dectol R & O Oils
 Delo 400 Motor Oils
 Delvac Oils
 Delvac SHC
 Delvac Special 10W-30
 Donax T Oils
 DTE Oils
 Duro
 Duro AW

EP Hydraulic Oils
 EP Industrial Oils
 EP Machine Oils
 Energol HL68
 Energol HLP C68
 Etna Oils
 Exxon ATF
 Factivis 52 – Conventional R & O Hydraulic Fluid
 Gulf Harmony AW
 Gulf Security AW
 Glide
 Hulburt 27 Series
 Hydraulic Series
 Hydraulic Oils
 Hydroil Series
 Industron 53 – Anti Wear Hydraulic Fluid
 Lubrite Motor 20W-40
 Mobil AFT 210
 Mobil AFT 220
 Mobilfluid 62
 Mobilfluid 423
 Mobil Hydraulic Oils
 Mobiloil Special
 Mobiloil Super 10W-40
 NUTO Oils
 OC Turbine Oils
 Peaco Oils
 Pennbell Oils
 Power-Tran Fluid
 Quadroil Series

Rando Oils
 Rando Oils HD
 Redind Oils
 Regal Oils R & O
 Rimula Oils
 Rotella Oils
 Rotella T Oils
 RPM Delo 200 Motor Oils
 RPM Delo 300 Motor Oils
 RPM Delo Special Motor Oils
 Rubilene
 Shell Brand
 Special Motor Oils
 Sun R & O Oils
 Suntac HP Oils
 Suntac WR Oils
 Sunvis 700 Oils
 Sunvis 800 Oils
 Sunvis 900 Oils
 Super Hydraulic Oils
 Supreme Motor Oils
 Tellus Oils
 Teresstic Oils
 Torque Fluids
 Torque Fluid 47
 Torque Fluid 56
 Tractor Hydraulic Fluid
 Union ATF Dexron
 Union ATF Type F
 Union C-2 Fluid
 Union C-P Oil
 Union Custom Motor Oil
 Union Gas Engine Oil
 Union Guardol Motor Oil
 Union Heavy Duty Motor Oil
 Union Hydraulic Oil AW
 Union Hydraulic Tractor Fluid
 Union Premium Motor Oil
 Union S-1 Motor Oil
 Union Special Motor Oil
 Union Super Motor Oil

Union Torque Correction Fluid
 Union Turbine Oil
 Union Turbine Oil XD
 Union Unax
 Union Unax AW
 Union Unax R & O
 Union Unax RX
 Union Unitec Motor Oil
 Univis J13
 Univis J26
 Univis P32
 Vactra Oils
 Vitrea Oils
 Way Lubricants
 XD-3 Motor Oils

SPECIALTY & TRUCK HOSE

LOW & MEDIUM PRESSURE HOSE

HIGH PRESSURE HOSE

HOSE FITTINGS

ADAPTERS & TUBE FITTINGS

ACCESSORIES & ASSEMBLY INSTRUCTIONS

HOSE ASSEMBLY EQUIPMENT

APPENDICES

Fluid Compatibility

WATER AND PETROLEUM OIL EMULSION (FR)

Maximum fluid temperature recommendation**

HOSE CLASSIFICATIONS (SEE P. 349)				
	1	2	3	4
H	+200°F	+250°F	+150°F	+200°F
LP	+200°F	+250°F	+150°F	+200°F

Fluid Name

Fluid Name
Aqualube
Astrol #587

Chevron FR Fluid D
Chrysler L-705
Citgo Pacemaker Invert FR Fluid
Conoco FR Hydraulic Fluid

Dasco IFR
Duro FR-HD

Fire Resistant Hydrafluid
Fire Resistant Hydraulic Fluid B
FR 3110 Hydraulic Fluid (invert)
Fyre-Safe W/O

Gulf R & D FR Fluid

Houghto-Safe 5046
Houghto-Safe 5046W
Hulsafe 500
Hy-Chock Oil
Hydrasol A

Ironsides #814-A
Irus Fluid 905

Kutwell 40

Masol Fire Resistant Fluid
Meltran FR 900
Mine Guard
Mobilmet S122

Penn Drake Hydraqua Fluid
Permamul FR
Puro FR Fluid
Pyrogard C
Pyrogard D

Quintolubric 957 Series
Quintolubric 958 Series

Regent Hydrolube #670

SAFOIL Hydraulic Fluid Anti-Wear
Sinclair Duro FR-HD
Solvac 1535G
Staysol FR
Sunsafe F

Union FR Fluid
Union Soluble Oil HD

Veedol Auburn FRH
Veedol Auburn FRH Concentrate

***See CAUTION on page 349 for maximum fluid temperatures and limiting ambient temperatures.*

WATER AND GLYCOL SOLUTION

Maximum fluid temperature recommendation**

HOSE CLASSIFICATIONS (SEE P. 349)				
	1	2	3	4
H	+200°F	+250°F	+150°F	C
LP	+200°F	+250°F	+150°F	C

Fluid Name

Chem-Trend HF-18
Chem-Trend HF-20
Chevron Glycol FR Fluids
Citgo Glycol FR Fluids
Citgo Glycol FR-20 XD
Citgo Pacemaker

Dasco FR 150
Dasco FR 200
Dasco FR 200 B
Dasco FR 310

Fyrguard 150
Fyrguard 200
Fyre-Safe 225

Gulf FR Fluid G-200
Gulf FR Fluid – G Series

Houghto-Safe 271
Houghto-Safe 416
Houghto-Safe 520
Houghto-Safe 525
Houghto-Safe 616
Houghto-Safe 620
Houghto-Safe 625
Houghto-Safe 640
Hydra Safe 620
Hydra Safe 625
Hydraulic Safety Fluid 200
Hydraulic Safety Fluid 300
Hyspin AF-1
Hyspin AF-2
Hyspin AF-3

Maxmul
Maxmul FR
Melsyn 200
Melsyn Glycol FR

Nyvac FR Fluid
Nyvac FR 200 Fluid
Nyvac 20 (WG)
Nyvac 30 (WG)

Park Water Glycol Hydraulic Fluid
Pennzoil Fluid FR 2X

Quintolubric 700 Series

Santosafe W/G 15
Santosafe W/G 20
Santosafe W/G 30
Standard Glycol FR #15
Standard Glycol FR #20
Standard Glycol FR #25

Ucon Hydrolube 150 CP
Ucon Hydrolube 200 CP
Ucon Hydrolube 275 CP
Ucon Hydrolube 300 CP
Ucon Hydrolube 550 CP
Ucon Hydrolube 900 CP
Ucon Hydrolube 150 DB
Ucon Hydrolube 275 DB
Ucon Hydrolube 150 LT
Ucon Hydrolube 200 LT

Ucon Hydrolube 275 LT
Ucon Hydrolube 300 LT
Ucon M-1
Ucon Hydrolube 200 NM
Ucon Hydrolube 300 NM

Fluid Compatibility

STRAIGHT PHOSPHATE-ESTER (FR)

Maximum fluid temperature recommendation**

HOSE CLASSIFICATIONS (SEE P. 349)				
	1	2	3	4
H	U	+400°F	+200°F	U
LP	U	+400°F	+200°F	U

Fluid Name

FR Fluids
Fyrquel 90
Fyrquel 150
Fyrquel 220
Fyrquel 300
Fyrquel 550
Fyrquel 1000
Fyrquel 150 R & O
Fyrquel 220 R & O
Fyrquel 550 R & O

Gulf FR Fluid P-37
Gulf FR Fluid P-40
Gulf FR Fluid P-43
Gulf FR Fluid P-45
Gulf FR Fluid P-47

Houghto-Safe 1010
Houghto-Safe 1055
Houghto-Safe 1115
Houghto-Safe 1120
Houghto-Safe 1130

Pyrogard 51
Pyrogard 53
Pyrogard 55

Safetytex 215

Skydraul 500A
Skydraul 7000

Univis P12

ESTER BLEND TURBINE OILS

Maximum fluid temperature recommendation**

HOSE CLASSIFICATIONS (SEE P. 349)				
	1	2	3	4
H	-	-	-	-
LP	+250°F	+450°F	+200°F	+300°F

Fluid Name

Stauffer Jet I
Stauffer Jet II

SILICONE OILS

Maximum fluid temperature recommendation**

HOSE CLASSIFICATIONS (SEE P. 349)				
	1	2	3	4
H	+200°F	+400°F	+200°F	+300°F
LP	+250°F	+450°F	+200°F	+300°F

Fluid Name

Dow Corning 200 Fluid (100CS)
Dow Corning QF1-2023
Dow Corning 4-3600
Dow Corning 3-3672

POLYOL-ESTER

Maximum fluid temperature recommendation**

HOSE CLASSIFICATIONS (SEE P. 349)				
	1	2	3	4
H	+200°F	+400°F	-	+225°F
LP	+200°F	+400°F	-	+250°F

Fluid Name

Quintolubric 822 Series

***See NOTE on page 349 for maximum fluid temperatures and limiting ambient temperatures.*

LUBRICANT COMPATIBILITY CHART

Lubricant	Hose Style						
	FC802	FC505	FC555	FC558	GH134	FC665	FC765
Mineral Oil	Y	Y	Y	N	N	Y	Y
PAG	Y	Y	Y	Y	Y	Y	Y
Ester Oil	Y	Y	Y	Y	Y	Y	Y
Alkylbenzene	Y	Y	Y	N	N	Y	Y

Y = Compatible
N = Non-compatible

SPECIALTY & TRUCK HOSE

LOW & MEDIUM PRESSURE HOSE

HIGH PRESSURE HOSE

HOSE FITTINGS

ADAPTERS & TUBE FITTINGS

ACCESSORIES & ASSEMBLY INSTRUCTIONS

HOSE ASSEMBLY EQUIPMENT

APPENDICES

SAE Recommended Practices

Selection, installation and maintenance of hose and assemblies — SAE J1273 October 1996

The following recommendations on selection, installation and maintenance of hose assemblies was established by the S.A.E. in 1991. Please read these general instructions carefully. More detailed information on many of these subjects is covered in this catalog.

1. Scope—Hose (also includes hose assemblies) has a finite life and there are a number of factors which will reduce its life.

This recommended practice is intended as a guide to assist system designers and/or users in the selection, installation, and maintenance of hose. The designers and users must make a systematic review of each application and then select, install, and maintain the hose to fulfill the requirements of the application. The following are general guidelines and are not necessarily a complete list.

WARNING: IMPROPER SELECTION, INSTALLATION, OR MAINTENANCE MAY RESULT IN PREMATURE FAILURES, BODILY INJURY, OR PROPERTY DAMAGE.

2. References

2.1 Applicable Documents—The following publications form a part of this specification to the extent specified herein. The latest issue of SAE publications shall apply.

2.1.1 SAE PUBLICATIONS—Available from SAE, 400 Commonwealth Drive, Warrendale, PA 15096-0001.

J516—Hydraulic Hose Fittings

J517—Hydraulic Hose

3. Selection—The following is a list of factors which must be considered before final hose selection can be made.

3.1 Pressure—After determining the system pressure, hose selection must be made so that the recommended maximum operating pressure is equal to or greater than the system pressure. Surge pressures higher than the maximum operating pressure will shorten hose life and must be taken into account by the hydraulic designer.

3.2 Suction—Hoses used for suction applications must be selected to insure the hose will withstand the negative pressure of the system.

3.3 Temperature—Care must be taken to insure that fluid and ambient temperatures, both static and transient, do not exceed the limitations of the hose. Special care must be taken when routing near hot manifolds.

3.4 Fluid Compatibility—Hose selection must assure compatibility of the hose tube, cover and fittings with the fluid used. Additional caution must be observed in hose selection for gaseous applications.

3.5 Size—Transmission of power by means of pressurized fluid varies with pressure and rate of flow. The size of the components must be adequate to keep pressure losses to a

minimum and avoid damage to the hose due to heat generation or excessive turbulence.

3.6 Routing—Attention must be given to optimum routing to minimize inherent problems.

3.7 Environment—Care must be taken to insure that the hose and fittings are either compatible with or protected from the environment to which they are exposed. Environmental conditions such as ultraviolet light, ozone, salt water, chemicals, and air pollutants can cause degradation and premature failure and, therefore, must be considered.

3.8 Mechanical Loads—External forces can significantly reduce hose life. Mechanical loads which must be considered include excessive flexing, twist, kinking, tensile or side loads, bend radius, and vibration. Use of swivel-type fittings or adapters may be required to insure no twist is put into the hose. Unusual applications may require special testing prior to hose selection.

3.9 Abrasion—While hose is designed with a reasonable level of abrasion resistance, care must be taken to protect the hose from excessive abrasion which can result in erosion, snagging and cutting of the hose cover. Exposure of the reinforcement will significantly accelerate hose failure.

3.10 Proper End Fitting—Care must be taken to insure proper compatibility exists between the hose and coupling selected based on the manufacturer's recommendations substantiated by testing to industry standards such as SAE J517. End fitting components from one manufacturer are usually not compatible with end fitting components supplied by another manufacturer (i.e., using a hose fitting nipple from one manufacturer with a hose socket from another manufacturer). It is the responsibility of the fabricator to consult the manufacturer's written instructions or the manufacturer directly for proper end fitting componentry.

3.11 Length—When establishing proper hose length, motion absorption, hose length changes due to pressure, as well as hose and machine tolerances must be considered.

3.12 Specifications and Standards—When selecting hose, government, industry and manufacturers' specifications and recommendations must be reviewed as applicable.

3.13 Hose Cleanliness—Hose components vary in cleanliness levels. Care must be taken to insure that the assemblies selected have an adequate level of cleanliness for the application.

3.14 Electrical Conductivity—Certain applications require that hose be non-conductive to prevent electrical current flow. Other applications require the hose to be sufficiently conductive to drain off static electricity. Hose and fittings must be chosen with these needs in mind.

4. Installation—After selection of proper hose, the following factors must be considered by the installer.

4.1 Pre-Installation Inspection—Prior to installation, a careful examination of the hose must be performed. All components must be checked for correct style, size and length. In addition, the hose must be examined for cleanliness, I.D. obstructions, blisters, loose cover, or any other visible defects.

4.2 Follow Manufacturers' Assembly Instructions—Hose assemblies may be fabricated by the manufacturer, an agent for or customer of the manufacturer, or by the user. Fabrication of permanently attached fittings to hydraulic hose requires specialized assembly equipment. Field-attachable fittings (screw style and segment clamp style) can usually be assembled without specialized equipment although many manufacturers provide equipment to assist in the operation.

SAE J517 hose from one manufacturer is usually not compatible with SAE J516 fittings supplied by another manufacturer. It is the responsibility of the fabricator to consult the manufacturer's written assembly instructions or the manufacturers directly before intermixing hose and fittings from two manufacturers. Similarly, assembly equipment from one manufacturer is usually not interchangeable with that of another manufacturer. It is the responsibility of the fabricator to consult the manufacturer's written instructions or the manufacturer directly for proper assembly equipment. Always follow the manufacturer's instructions for proper preparation and fabrication of hose assemblies.

4.3 Minimum Bend Radius—Installation at less than minimum bend radius may significantly reduce hose life. Particular attention must be given to preclude sharp bending at the hose/fitting juncture.

4.4 Twist Angle and Orientation—Hose installations must be such that relative motion of machine components produces bending of the hose rather than twisting.

4.5 Securement—In many applications, it may be necessary to restrain, protect, or guide the hose to protect it from damage by unnecessary flexing, pressure surges, and contact with other mechanical components. Care must be taken to insure such restraints do not introduce additional stress or wear points.

4.6 Proper Connection of Ports—Proper physical installation of the hose requires a correctly installed port connection while insuring that no twist or torque is put into the hose.

4.7 Avoid External Damage—Proper installation is not complete without insuring that tensile loads, side loads, kinking, flattening, potential abrasion, thread damage, or damage to sealing surfaces are corrected or eliminated.

4.8 System Check Out—After completing the installation, all air entrapment must be eliminated and the system pressurized to the maximum system pressure and checked for proper function and freedom from leaks.

NOTE: Avoid potential hazardous areas while testing.

5. Maintenance—Even with proper selection and installation, hose life may be significantly reduced without a continuing maintenance program. Frequency should be determined by the severity of the application and risk potential. A maintenance program should include the following as a minimum.

5.1 Hose Storage—Hose products in storage can be affected adversely by temperature, humidity, ozone, sunlight, oils, solvents, corrosive liquids and fumes, insects, rodents and radioactive materials. Storage areas should be relatively cool and dark and free of dust, dirt, dampness and mildew.

5.2 Visual Inspection—Any of the following conditions requires replacement of the hose:

- Leaks at fitting or in hose (leaking fluid is a fire hazard)
- Damaged, cut, or abraded cover (any reinforcement exposed)
- Kinked, crushed, flattened, or twisted hose
- Hard, stiff, heat cracked or charred hose
- Blistered, soft, degraded, or loose cover
- Cracked, damaged, or badly corroded fittings
- Fitting slippage on hose

5.3 Visual Inspection—The following items must be tightened, repaired, or replaced as required:

- Leaking port conditions
- Clamps, guards, shields
- Remove excessive dirt buildup
- System fluid level, fluid type, and any air entrapment

5.4 Functional Test—Operate the system at maximum operating pressure and check for possible malfunctions and freedom from leaks.

NOTE: Avoid potential hazardous areas while testing.

5.5 Replacement Intervals—Specific replacement intervals must be considered based on previous service life, government or industry recommendations, or when failures could result in unacceptable down time, damage, or injury risk.

Flow Capacities

Flow capacities of hose assemblies at suggested flow velocities

The chart below is designed and provided as an aid in the determination of the correct hose size.

Example: At 13 U.S. gallons per minute, what is proper hose size within the suggested velocity range for pressure lines?

Solution: Locate 13 U.S. gallons per minute in the left hand column and 10 feet per second in the right hand column (the center of the suggested velocity range for pressure lines). Lay a straightedge across the two points. The inside diameter is shown in the center column nearest the straight edge.

For suction hose, follow the same procedure except use suggested velocity range for pump inlet lines in the right hand column.

Based on Formula

$$\text{AREA (SQ. IN.)} = \frac{\text{G.P.M.} \times 0.3208}{\text{VELOCITY (FT./SEC.)}}$$

*Suggestions are for oils having a maximum viscosity of 315 S.S.U. at +100°F (+38°C) and operating at temperatures between +65°F and +155°F (+54°C to +69°C). Under certain conditions, velocities in pressure lines can be increased up to 25 feet per second. Contact Aeroquip with specific information on your application.

To convert U.S. gallons into Imperial gallons multiply U.S. gallons by 0.83267. Imperial gallons into U.S. gallons multiply Imperial gallons by 1.20095. U.S. gallons to litres multiply by 3.785. Litres to U.S. gallons, multiply by 0.2642.

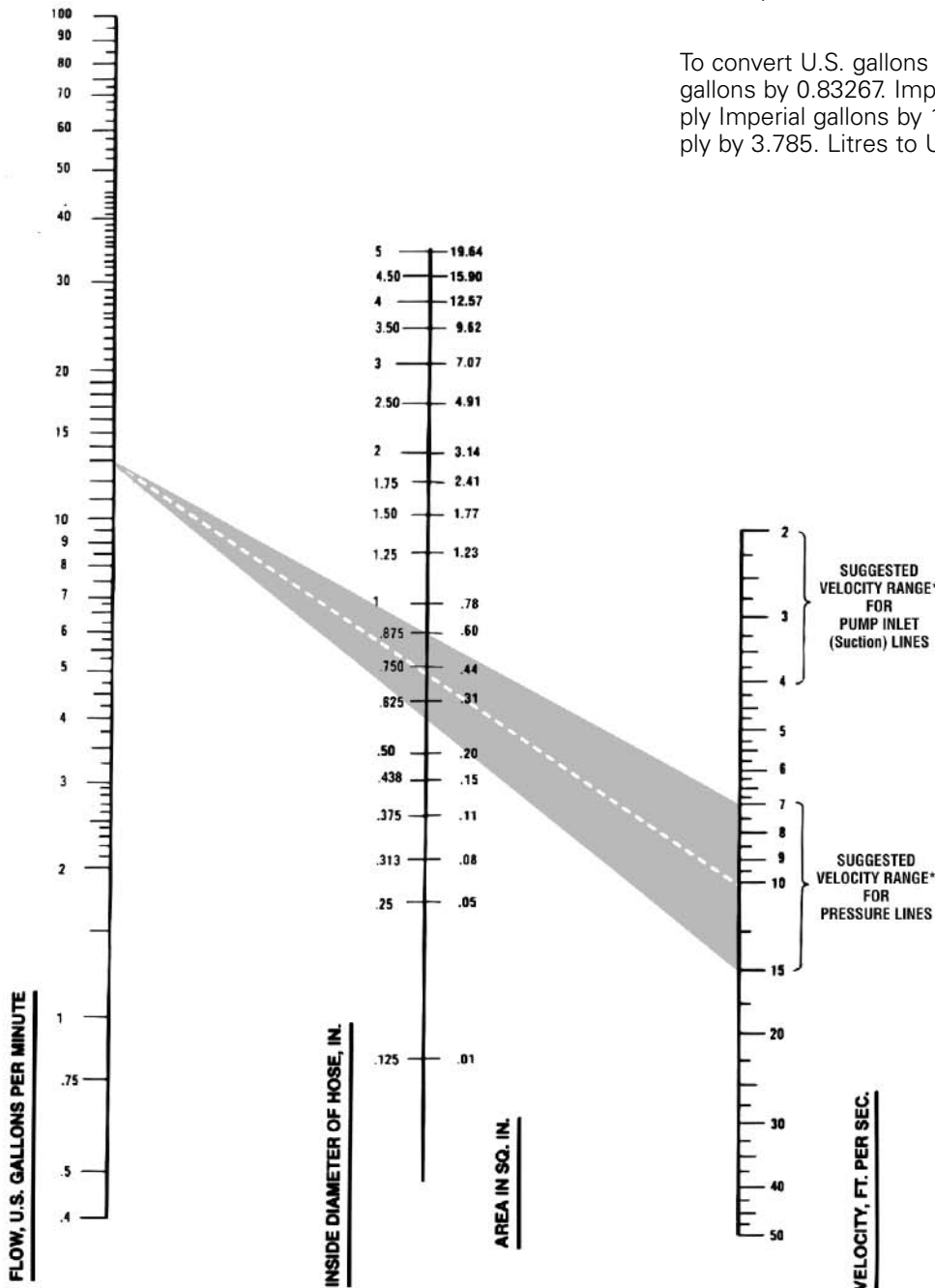

SPECIALTY & TRUCK HOSE

LOW & MEDIUM PRESSURE HOSE

HIGH PRESSURE HOSE

HOSE FITTINGS

ADAPTERS & TUBE FITTINGS

ACCESSORIES & ASSEMBLY INSTRUCTIONS

HOSE ASSEMBLY EQUIPMENT

APPENDICES

Hose Routing and Installation

SPECIALTY & TRUCK HOSE

LOW & MEDIUM PRESSURE HOSE

HIGH PRESSURE HOSE

HOSE FITTINGS

ADAPTERS & TUBE FITTINGS

ACCESSORIES & ASSEMBLY INSTRUCTIONS

HOSE ASSEMBLY EQUIPMENT

APPENDICES

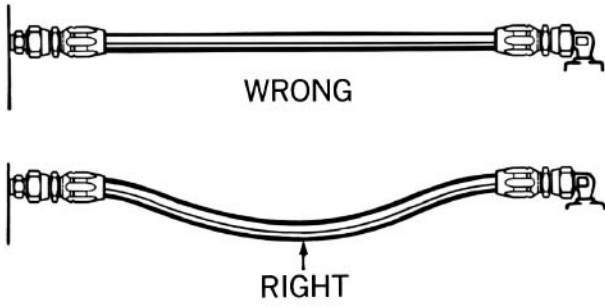

Under pressure, a hose may change in length. Always provide some slack in the hose to allow for this shortening or elongation.

(However, excessive slack in hose lines may cause poor appearance.)

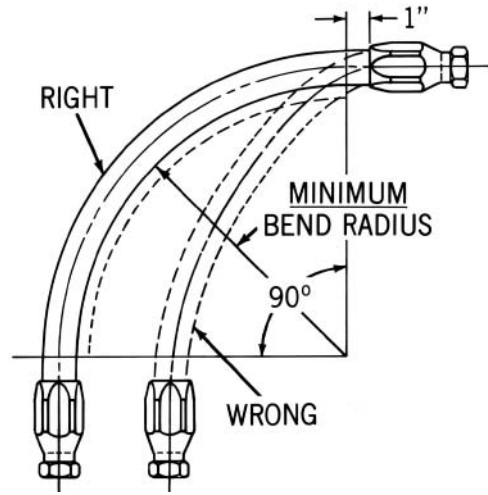

At bends, provide sufficient hose so that it does not have a bend radius less than its recommended minimum bend radius. Too tight a bend may kink the hose and

restrict or stop the fluid flow. In many cases the proper use of adapters and hose fittings can eliminate tight bends or kinks.

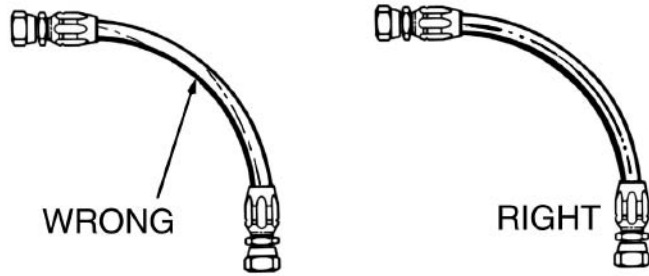

If a hose is installed with a twist in it, operating pressures tend to force it straight. This can loosen the

fitting nut. Twisting can cause reinforcement separation and the hose could burst at the point of strain.

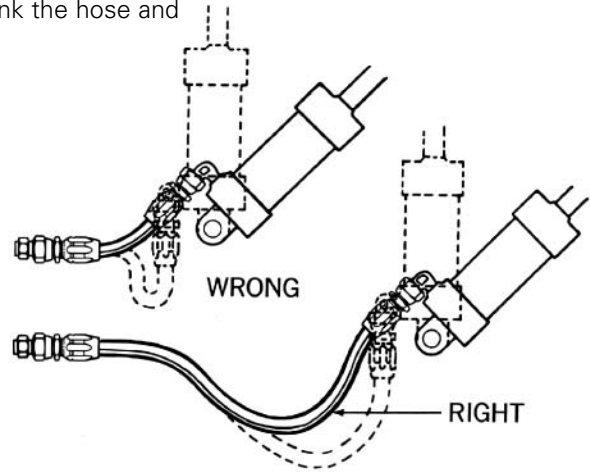

In applications where there is considerable vibration or flexing, allow additional hose length. The metal hose fittings, of course, are not flex-

ible, and proper installation protects metal parts from undue stress, and avoids kinks in the hose.

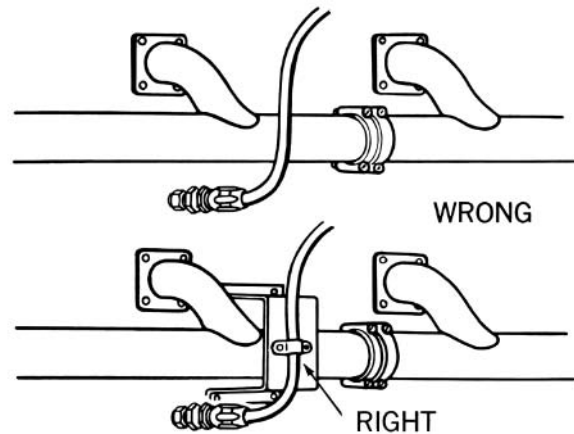

When hose lines pass near an exhaust manifold or other heat source, they should be insulated by a heat resistant boot, firesleeve or a metal baffle. In any application, brackets and clamps keep hoses in place and reduce abrasion.

For installations where abrasion to hose cover cannot be prevented with the use of clamps or brackets, a steel protective coil or abrasion resistant sleeve should be placed over the hose.

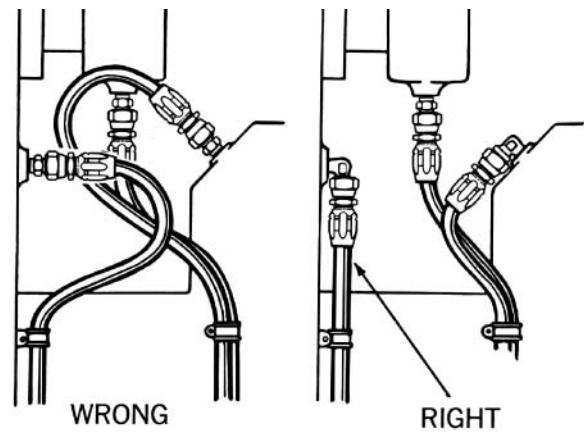

When 90° adapters were used, this assembly became neater-looking and easier to

inspect and maintain. It uses less hose, too!

Everyone in maintenance encounters hose failures. Normally, there is no problem. The hose is replaced and the equipment goes back in operation. Occasionally the failures come too frequently – the same equipment with the same problems keep popping up. At this point the task is to determine and correct the cause of these repeated failures.

Improper application

Beginning with the most obvious, the most common cause of hose failures – Improper Application – compare the hose specifications with the requirements of the application.

Pay particular attention to the following areas:

1. The maximum operating pressure of the hose.
2. The recommended temperature range of the hose.
3. Whether the hose is rated for vacuum service.
4. The fluid compatibility of the hose.

Check all of these areas against the requirements of the application. If they don't match up, you need to select another hose. It's a good idea at this point to call on your local hose distributor for assistance in selecting the proper hose. Eaton's distributors, for example, are well equipped to perform this service for you. Distributor personnel attend special training courses in hydraulics and hose application conducted by the company. Or, if your problem is particularly difficult, the distributor can call on the services of Eaton's

Field Engineering Staff. The company will send in a hose and hydraulic specialist to study the problem and come up with a solution.

Improper assembly and installation

The second major cause of premature hose failure is improper assembly and installation procedures. This can involve anything from using the wrong fitting on a hose, to poor routing of the hose.

Eaton provides excellent training material that you can use to combat this problem. A little time spent in training your maintenance people could pay big dividends in reduced downtime.

You can make use of the material available from Eaton to improve your hose assembly and installation techniques.

This material is available free from Eaton Corporation 14615 Lone Oak Road, Eden Prairie, MN 55344 USA, 952/937-9800.

External damage

External damage can range from abrasion and corrosion, to hose that is crushed by a lift truck. These are problems that can normally be solved simply once the cause is identified. The hose can be re-routed or clamped, or a fire sleeve or abrasion guard can be used.

In the case of corrosion, the answer may be as simple as changing to a hose with a more corrosion resistant cover or re-routing the hose to avoid the corrosive element.

Faulty equipment

Too frequent or premature hose failure can be the symptom of a malfunction in your equipment. This is a factor that should be considered since prompt corrective action can sometimes avoid serious and costly equipment breakdown. Reprints of an article on "Troubleshooting Hydraulic Systems," which tells you how to spot problems in a hydraulic system are available from Eaton.

Faulty hose

Occasionally a failure problem will lie in the hose itself. The most likely cause of a faulty rubber hose is old age. Check the lay line on the hose to determine the date of manufacture. (2Q99 means second quarter 1999.) The hose may have exceeded its recommended shelf life. If you suspect that the problem lies in the manufacture of the hose (and don't jump to this conclusion until you have exhausted the other possibilities) contact your distributor. Given effective quality control methods, the odds of a faulty batch of hose being released for sale are extremely small. So make sure that you haven't overlooked some other problem area.

Analyzing failures

A physical examination of the failed hose can often offer a clue to the cause of the failure. Following are 22 symptoms to look for along with the conditions that could cause them:



1. Symptom: The hose tube is very hard and has cracked.

Cause: Heat has a tendency to leach the plasticizers out of the tube. This is a material that gives the hose its flexibility or plasticity.

Aerated oil causes oxidation to occur in the tube. This reaction of oxygen on a rubber product will cause it to harden. Any combination of oxygen and heat will greatly accelerate the hardening of the hose tube. Cavitation occurring inside the tube would have the same effect.



2. Symptom: The hose is cracked both externally and internally but the elastomeric materials are soft and flexible at room temperature.

Cause: The probable reason is intense cold ambient conditions while the hose was flexed. Most standard hoses are rated to -40°F (-40°C). Some AQP hoses are rated at -55°F (-49°C). Military specified hoses are generally rated to -65°F (-54°C). PTFE hose is rated to -100°F (-73°C). Some Everflex Polyon thermoplastic hoses are rated at -65°F (-54°C).

3. Symptom: The hose has burst and examination of the wire reinforcement after stripping back the cover reveals random broken wires the entire length of the hose.



Cause: This would indicate a high frequency pressure impulse condition. SAE impulse test requirements for a double wire braid reinforcement are 200,000 cycles at 133% of recommended working pressure. The SAE impulse test requirements for a four spiral wrapped reinforcement (100R12) are 500,000 cycles at 133% maximum operating and at +250°F (121°C). If the extrapolated impulses in a system amount to over a million in a relatively short time a spiral reinforced hose would be the better choice.

4. Symptom: The hose has burst, but there is no indication of multiple broken wires the entire length of the hose. The hose may



have burst in more than one place.

Cause: This would indicate that the pressure has exceeded the minimum burst strength of the hose. Either a stronger hose is needed or the hydraulic circuit has a malfunction which is causing unusually high pressure conditions.

5. Symptom: Hose has burst. An examination indicates the the wire braid is rusted and the cover has been cut, abraded or deteriorated badly.



Cause: The primary function of the cover is to protect the reinforcement. Elements that may destroy or remove the hose covers are:

1. Abrasion
2. Cutting
3. Battery Acid
4. Steam Cleaners
5. Chemical Cleaning Solutions
6. Muriatic Acid (for cement clean-up)
7. Salt Water
8. Heat
9. Extreme Cold

Once the cover protection is gone the wire reinforcement is susceptible to attack from moisture or other corrosive matter.

6. Symptom: Hose has burst on the outside bend and appears to be elliptical in the bent section. In the case of a pump supply line, the pump is noisy and very hot. The exhaust line of the pump is hard and brittle.

Cause: Violation of the minimum bend radius is most likely the problem in both cases. Check the minimum bend radius and make sure that the application is within specifications. In the case of the pump supply line partial collapse of the hose is causing the pump to cavitate creating both noise and heat. This is a most serious situation and will result in catastrophic pump failure if not corrected.

7. Symptom: Hose appears to be flattened out in one or two areas and appears to be kinked. It has burst in this area and also appears to be twisted.



Cause: Torquing of a hydraulic control hose will tear loose the reinforcement layers and allow the hose to burst through the enlarged gaps between the braided plaits of wire strands. Use swivel fittings or joints to be sure there is no twisting force on a hydraulic hose.

8. Symptom: Hose type has broken loose from the reinforcement and piled up at the end of the hose. In some cases it may protrude from the end of the hose fitting.

Cause: The probable cause is high vacuum or the wrong hose for vacuum service. No vacuum is recommended for double wire braid, 4 and 6 spiral wire hose unless some sort of internal coil support is used. Even though a hose is rated for vacuum service, if it is kinked, flattened out or bent too sharply this type of failure may occur.

9. Symptom: Hose has burst about six to eight inches away from the end fitting. The wire braid is rusted. There are no cuts or abrasions of the outer cover.

Cause: Improper assembly of the hose end fitting allowing moisture to enter around the edge of the fitting socket. The moisture will wick through the reinforcement. The heat generated by the system will drive it out around the fitting area but six to eight inches away it will be entrapped between the inner line and outer cover causing corrosion of the wire reinforcement.

10. Symptom: There are blisters in the cover of the hose. If one pricks the blisters, oil will be found in them.

Cause: A minute pin hole in the hose tube is allowing the high pressure oil to seep between it and the cover. Eventually it will form a blister wherever the cover adhesion is weakest. In the case of a screw together reusable fitting insufficient lubrication of the hose and fitting can cause this condition because the dry tube will adhere to the rotating nipple and tear enough to allow seepage. Faulty hose can also cause this condition.

11. Symptom: Blistering of the hose cover where a gaseous fluid is being used.



Cause: The high pressure gas is effusing through the hose tube, gathering under the cover and eventually forming a blister wherever the adhesion is weakest. Specially constructed hoses are available for high pressure gaseous applications. Your supplier can advise you on the proper hose to use in these cases.

12. Symptom: Fitting blew off of the end of the hose.

Cause: It may be that the wrong fitting has been put on the hose. Recheck manufacturer's specifications and part numbers.

In the case of a crimped fitting the wrong machine setting may have been used resulting in over or undercrimping. The socket of a screw together fitting for multiple wire braided hose may be worn beyond its tolerance. The swaging dies in a swaged hose assembly may be worn beyond the manufacturer's tolerances.

The fitting may have been applied improperly to the hose. Check manufacturer's instructions. The hose may have been installed without leaving enough slack to compensate for the possible 4% shortening that may occur when the hose is pressurized. This will impose a great force on the fitting. The hose itself may be out of tolerance.

13. Symptom: The tube of the hose is badly deteriorated with evidences of extreme swelling. In some cases the hose tube may be partially “washed out.”

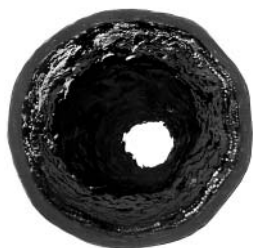

Cause: Indications are that the hose tube is not compatible with the agent being carried. Even though the agent is normally compatible, the addition of heat can be the catalyst that can cause inner liner deterioration. Consult your hose supplier for a compatibility list or present him with a sample of the fluid being conducted by the hose for analysis. Make sure that the operating temperatures both internal and external do not exceed recommendations.

14. Symptom: Hose has burst. The hose cover is badly deteriorated and the surface of the rubber is crazed.

Cause: This could be simply old age. The crazed appearance is the effect of weathering and ozone over a period of time. Try to determine the age of the hose. Some manufacturers print or emboss the cure date on the outside of the hose. As an example, Aeroquip hose would show “4Q01” which would mean that the hose was manufactured during the fourth quarter (October, November or December) of 2001.

15. Symptom: Hose is leaking at the fitting because of a crack in the metal tube adjacent to the braze on a split flange head.

Cause: Because the crack is adjacent to the braze and not in the braze this is a stress failure brought on by a hose that is trying to shorten under pressure and has insufficient slack in it to do so.

We have cured dozens of these problems by lengthening the hose assembly or changing the routing to relieve the forces on the fitting.

16. Symptom: A spiral reinforced hose has burst and literally split open with the wire exploded out and badly entangled.



Cause: The hose is too short to accommodate the change in length occurring while it is pressured.

17. Symptom: Hose is badly flattened out in the burst area. The tube is very hard down stream of the burst but appears normal up stream of the burst.



Cause: The hose has been kinked either by bending it too sharply or by squashing it in some way so that a major restriction was created. As the velocity of the fluid increases through the restriction the pressure decreases to the vaporization point of the fluid being conveyed. This is commonly called cavitation, and causes heat and rapid oxidation to take place which hardens the tube of the hose downstream of the restriction.

18. Symptom: Hose has not burst but it is leaking profusely. A bisection of the hose reveals that the tube has been gouged through to the wire braid for a distance of approximately two inches.

Cause: This failure would indicate that erosion of the hose tube has taken place. A high velocity needle like fluid stream being emitted from an orifice and impinging at a single point on the hose tube will hydraulically remove a section of it. Be sure that the hose is not bent close to a port that is orificed.

In some cases where high velocities are encountered particles in the fluid can cause considerable erosion in bent sections of the hose assembly.

19. Symptom: The hose fitting has been pulled out of the hose. The hose has been considerably stretched out in length. This may not be a high pressure application.

Cause: Insufficient support of the hose. It is very necessary to support very long lengths of hose, especially if they are vertical. The weight of the hose along with the weight of the fluid inside the hose in these cases is being imposed on the hose fitting. This force can be transmitted to a wire rope or chain by clamping the hose to it much like the utilities support bundles of wire from pole to pole. Be sure to leave sufficient slack in the hose between clamps to make up for the possible 4% shortening that could take place when the hose is pressurized.

20. Symptom: The hose has not burst but it is leaking profusely. An examination of the bisected hose reveals that the tube has burst inwardly.

Cause: This type of failure is commonly referred to as hose tube blow down. It is usually associated with very low viscosity fluids such as air, nitrogen, freon and other gases. What happens is that under high pressure conditions the gases will effuse into the pores of the hose tube charging them up like miniature accumulators. If the pressure is very suddenly reduced to zero the entrapped gases literally explode out of the tube often tearing holes in it. In some hose constructions a second

hose tube made from a plastic such as nylon, is inserted into the hose.

A small leak will allow the gaseous fluid to seep between the two inner liners and when the pressure is reduced to zero the innermost liner will collapse because of the entrapped pressure around its outer diameter.

21. Symptom: PTFE hose assembly has collapsed internally in one or more places.

Cause: One of the most common causes for this is improper handling of the PTFE assembly. PTFE is a thermoplastic material which is not rubber-like. When bent sharply it simply collapses. This type of collapse is localized in one area and is radial. When the PTFE tube is folded longitudinally in one or more places this could be the result of heat (which softens the hose tube) along with vacuum conditions inside of it. Because of the additional tension of the wire braid reinforcement inherent with this type of hose, there is always a radial tension on the tube trying to push it in. Rapid cycling from a very hot agent in the hose to a very cold agent in the hose can produce the same type of failure. Eaton offers an internal support coil that will eliminate this problem.

22. Symptom: A PTFE hose assembly has developed a pin hole leak or several pin hole leaks.

Cause: This situation occurs when a petroleum base fluid, with a low viscosity, is flowing at a high velocity. This condition can generate high voltage due to static electricity. The high voltage is seeking a ground connection and the only ground connection available is the braided stainless steel reinforcement. This causes an electric arc, which penetrates through the PTFE tube as it travels to the reinforcement. Specially constructed PTFE tubes are available that have enough carbon black in them so as to be conductive. They will “drain off” the static electricity and preclude this problem.

How to Identify Fluid Connectors

Measuring Tools—Order part number FT1341 for The Identification Tool Kit. A seat angle gauge, thread pitch gauge and an I.D./O.D. caliper are necessary to make accurate measurements of commonly used connectors. Eaton offers a unique new caliper that offers the capabilities of both a caliper and a seat angle gauge in one unit.

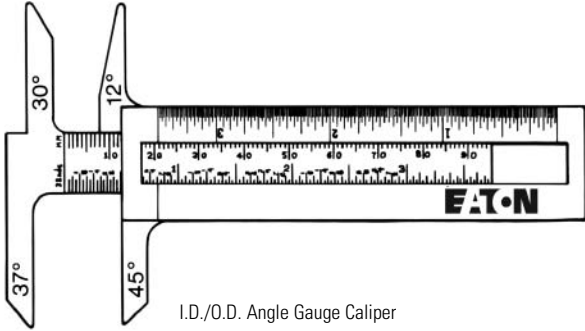

I.D./O.D. Angle Gauge Caliper

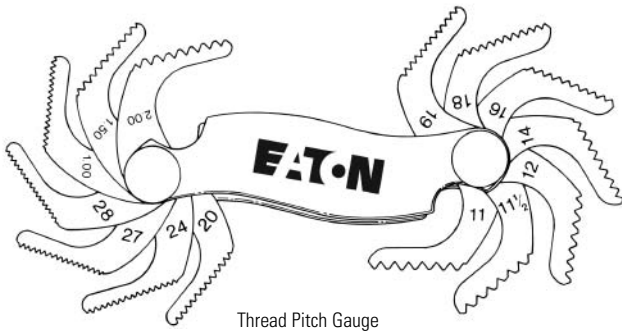

Thread Pitch Gauge

How to Measure Threads

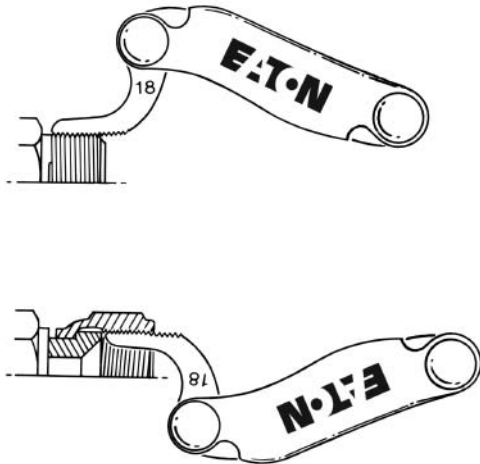

Use a thread pitch gauge to determine the number of threads per inch or the distance between threads in metric connections. Place the gauge on the threads until the fit is snug. Match the measurement to the charts.

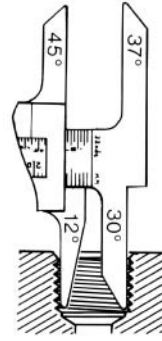

I.D.

Measure the thread diameter with an I.D./O.D. caliper as shown.

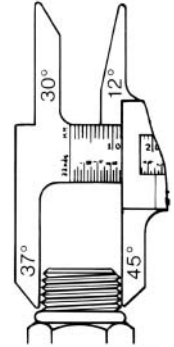

O.D.

Match the measurements to the charts.

How to Measure Sealing Surface Angles

Female connections are usually measured by inserting the gauge into the connection and placing it on the sealing surface. If the centerlines of the connection and gauge are parallel, the correct angle has been determined.

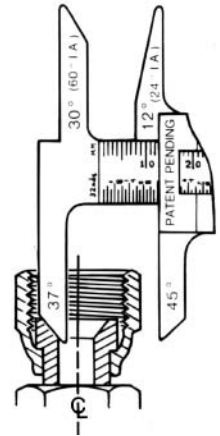

Male flare type connectors are usually measured by placing the gauge on the sealing surface. If the centerlines of the connection and gauge are parallel, the correct angle has been determined.

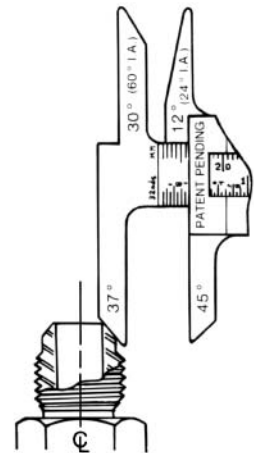

Thread Size Chart

The following chart is intended as a quick reference guide for thread size by dash size.

Dash size	N.P.T.F.	N.P.S.M. Approx. Dia.	SAE 45° Auto. Refrig.	SAE 37° (J.I.C.) Hydraulic	SAE O-Ring Boss	P.T.T. 30° Automotive	SAE Invert. Flare	ORS
-02	1/8-27	1/8-27	5/16-24	5/16-24	5/16-24		5/16-24	
-03			3/8-24	3/8-24	3/8-24		3/8-24	
-04	1/4-18	1/4-18	7/16-20	7/16-20	7/16-20		7/16-24	9/16-18
-05			1/2-20	1/2-20	1/2-20		1/2-20	
-06	3/8-18	3/8-18	5/8-18	9/16-18	9/16-18		5/8-18	11/16-16
-07			11/16-24				11/16-18	
-08	1/2-14	1/2-14	3/4-16	3/4-16	3/4-16		3/4-18	13/16-16
-10			7/8-14	7/8-14	7/8-14		7/8-18	1-14
-12	3/4-14	3/4-14	1 1/16-14	1 1/16-12	1 1/16-12		1 1/16-16	1 3/16-12
-14				1 3/16-12	1 3/16-12			
-16	1-11 1/2	1-11 1/2		1 5/16-12	1 5/16-12	1 5/16-14		1 7/16-12
-20	1 1/4-11 1/2	1 1/4-11 1/2		1 5/8-12	1 5/8-12	1 5/8-14		1 11/16-12
-24	1 1/2-11 1/2	1 1/2-11 1/2		1 7/8-12	1 7/8-12	1 7/8-14		2-12
-32	2-11 1/2	2-11 1/2		2 1/2-12	2 1/2-12	2 1/2-12		
-40	2 1/2-8	2 1/2-8		3-12	3-12			
-48	3-8	3-8		3 1/2-12	3 1/2-12			

Through hole dimensions

All dimensions are nominal. In jump size bodies, the minimum through hole dimensions will correspond to the smallest dash size.

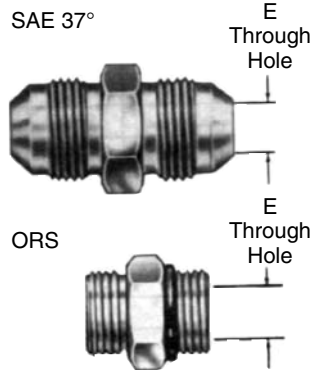

Dash Size	E through hole			
	SAE 37°		ORS	
	mm	in	mm	in
-03	3,0	0.12		
-04	4,3	0.17	4,3	0.17
-05	5,8	0.23		
-06	7,6	0.30	6,6	0.26
-08	9,9	0.39	9,7	0.38
-10	12,2	0.48	12,2	0.48
-12	15,5	0.61	15,5	0.61
-16	21,3	0.84	20,6	0.81
-20	25,8	1.08	26,7	1.05
-24	33,3	1.31	33,3	1.31
-32	45,2	1.78		

SPECIALTY & TRUCK HOSE

LOW & MEDIUM PRESSURE HOSE

HIGH PRESSURE HOSE

HOSE FITTINGS

ADAPTERS & TUBE FITTINGS

ACCESSORIES & ASSEMBLY INSTRUCTIONS

HOSE ASSEMBLY EQUIPMENT

APPENDICES

How to Measure Non-Threaded Connections

Four Bolt Flange—First measure the port hole diameter using the caliper. Next, measure the longest bolt hole spacing from center-to-center or measure the flange head diameter.

Staplok—Measure the male diameter with the O.D. portion of the caliper. Measure the female half by inserting the I.D. portion of the caliper into the through hole.

American Connections

NPTF (National Pipe Tapered Fuel)

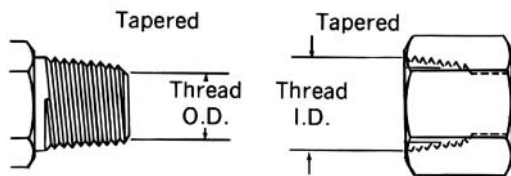

This connection is still widely used in fluid power systems, even though it is not recommended by the National Fluid Power Association (NFPA) for use

in hydraulic applications. The thread is tapered and the seal takes place by deformation of the threads.

NPTF Threads

Measure thread diameter and subtract 1/4-inch to find the nominal pipe size.

Inch Size	Dash size	Nominal Thread size	Male Thread O.D. inch		Female thread I.D. inch	
			fraction	decimal	fraction	decimal
1/8	02	1/8-27	13/32	.41	3/8	.38
1/4	04	1/4-18	17/32	.54	1/2	.49
3/8	06	3/8-18	11/16	.68	5/8	.63
1/2	08	1/2-14	27/32	.84	25/32	.77
3/4	12	3/4-14	11/16	1.05	1	.98
1	16	1-11 1/2	15/16	1.32	1 1/4	1.24
1 1/4	20	1 1/4-11 1/2	1 21/32	1.66	1 19/32	.58
1 1/2	24	1 1/2-11 1/2	1 29/32	1.90	1 13/16	1.82
2	32	2-11 1/2	2 3/8	2.38	2 5/16	2.30

Dash Numbers

Most fluid piping system sizes in the United States are measured by dash numbers. These are universally used abbreviations for the size of the component expressed as the numerator of the fraction with the

denominator always being 16. For example, a -04 port is 4/16 or 1/4-inch. Dash numbers are usually nominal (in name only) and are abbreviations that make ordering of components easier.

NPSM (National Pipe Straight Mechanical)

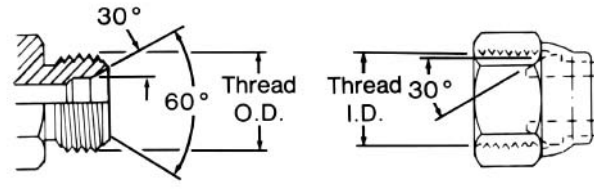

This connection is sometimes used in fluid power systems. The female half has a straight thread and an inverted 30° seat. The male half of the connection has a straight thread and a 30° internal chamfer. The seal

takes place by compression of the 30° seat on the chamfer. The threads hold the connection mechanically.

NOTE: A properly chamfered NPTF male will also seal with the NPSM female.

Inch Size	Dash size	Nominal Thread size	Male Thread O.D. inch		Female thread I.D. inch	
			fraction	decimal	fraction	decimal
1/8	02	1/8-27	13/32	.41	3/8	.38
1/4	04	1/4-18	17/32	.54	1/2	.49
3/8	06	3/8-18	11/16	.68	5/8	.63
1/2	08	1/2-14	27/32	.84	25/32	.77
3/4	12	3/4-14	11/16	1.05	1	.98
1	16	1-11 1/2	15/16	1.32	1 1/4	1.24
1 1/4	20	1 1/4-11 1/2	1 21/32	1.66	1 19/32	.58
1 1/2	24	1 1/2-11 1/2	1 29/32	1.90	1 13/16	1.82
2	32	2-11 1/2	2 3/8	2.38	2 5/16	2.30

American Connections

SAE J1926 Straight Thread O-Ring Boss (ORB)

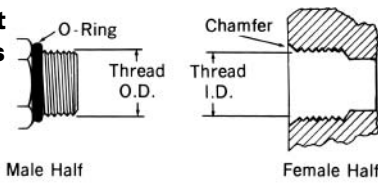

This port connection is recommended by the NFPA for optimum leakage control in medium and high pressure hydraulic systems. The male connector has a straight thread and an O-Ring. The female port has a straight

thread, a machined surface (minimum spotface) and a chamfer to accept the O-Ring. The seal takes place by compressing the O-Ring into the chamfer. The threads hold the connection mechanically.

Inch Size	Dash size	Nominal Thread size	Male Thread O.D. inch		Female Thread O.D. inch	
			fraction	decimal	fraction	decimal
1/8	02	5/16-24	5/16	.31	9/32	.27
3/16	03	3/8-24	3/8	.38	11/32	.34
1/4	04	7/16-20	7/16	.44	13/32	.39
5/16	05	1/2-20	1/2	.50	15/32	.45
3/8	06	9/16-18	9/16	.56	17/32	.51
1/2	08	3/4-16	3/4	.75	3/4	.69
5/8	10	7/8-14	7/8	.88	13/16	.81
3/4	12	1 1/16-12	1 1/16	1.06	1	.98
7/8	14	1 3/16-12	1 3/16	1.19	1 1/8	1.13
1	16	1 5/16-12	1 5/16	1.31	1 1/4	1.23
1 1/4	20	1 5/8-12	1 5/8	1.63	1 9/16	1.54
1 1/2	24	1 7/8-12	1 7/8	1.88	1 13/16	1.79
2	32	2 1/2-12	2 1/2	2.50	2 7/16	2.42

SAE J514 37° Hydraulic

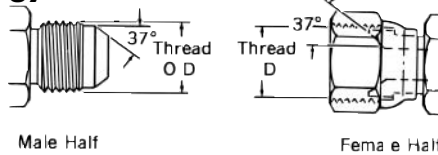

This connection is very common in fluid power systems. Both the male and female halves of the connections have 37° seats. The seal takes place by establishing a line contact between the male flare and the female cone seat.

The threads hold the connection mechanically. CAUTION: In the -02, -03, -04, -05, -08 and -10 sizes, the threads of the SAE 45° flare and the SAE 37° flare are the same. However, the sealing surface angles are not the same.

Inch Size	Dash size	Nominal Thread size	Male Thread O.D. inch		Female Thread O.D. inch	
			fraction	decimal	fraction	decimal
1/8	02	5/16-24	5/16	.31	9/32	.27
3/16	03	3/8-24	3/8	.38	11/32	.34
1/4	04	7/16-20	7/16	.44	13/32	.39
5/16	05	1/2-20	1/2	.50	15/32	.45
3/8	06	9/16-18	9/16	.56	17/32	.51
1/2	08	3/4-16	3/4	.75	3/4	.69
5/8	10	7/8-14	7/8	.88	13/16	.81
3/4	12	1 1/16-12	1 1/16	1.06	1	.98
7/8	14	1 3/16-12	1 3/16	1.19	1 1/8	1.13
1	16	1 5/16-12	1 5/16	1.31	1 1/4	1.23
1 1/4	20	1 5/8-12	1 5/8	1.63	1 9/16	1.54
1 1/2	24	1 7/8-12	1 7/8	1.88	1 13/16	1.79
2	32	2 1/2-12	2 1/2	2.50	2 7/16	2.42

ORS SAE J1453 O-Ring Face Seal

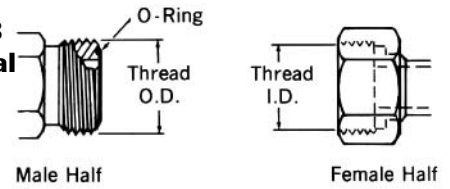

This connection offers the very best leakage control available today. The male connector has a straight thread and an O-Ring in the face. The female has a straight thread and a machined flat face. The seal

takes place by compressing the O-Ring onto the flat face of the female, similar to the split flange type fitting. The threads hold the connection mechanically.

Inch Size	Dash size	Nominal Thread size	Male Thread O.D. inch		Female Thread O.D. inch	
			fraction	decimal	fraction	decimal
1/4	04	9/16-18	9/16	.56	17/32	.51
3/8	06	11/16-16	11/16	.69	5/8	.63
1/2	08	13/16-16	13/16	.82	3/4	.75
5/8	10	1-14	1	1.00	15/16	.93
3/4	12	13/16-12	13/16	1.19	1 1/8	1.11
1	16	1 7/16-12	1 7/16	1.44	1 3/8	1.36
1 1/4	20	1 11/16-12	1 11/16	1.69	1 5/8	1.61
1 1/2	24	2-12	2	2.00	1 15/16	1.92

SAE J512 Inverted

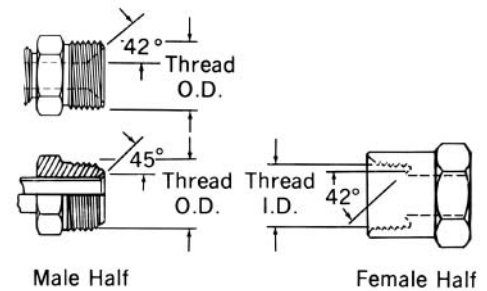

This connection is frequently used in automotive systems. The male connector can either be a 45° flare in the tube fitting form or a 42° seat in the machined adapter form. The

female has a straight thread with a 42° inverted flare. The seal takes place on the flared surfaces. The threads hold the connection mechanically.

Inch Size	Dash size	Nominal Thread size	Male Thread O.D. inch		Female Thread O.D. inch	
			fraction	decimal	fraction	decimal
1/8	02	5/16-24	5/16	.32	9/32	.28
3/16	03	3/8-24	3/8	.38	11/32	.34
1/4	04	7/16-24	7/16	.44	13/32	.40
5/16	05	1/2-20	1/2	.50	15/32	.45
3/8	06	5/8-18	5/8	.63	9/16	.57
7/16	07	11/16-18	11/16	.69	5/8	.63
1/2	08	3/4-18	3/4	.75	23/32	.70
5/8	10	7/8-18	7/8	.88	13/16	.82
3/4	12	1 1/16-16	1 1/16	1.06	1	1.00

SAE J512 45°

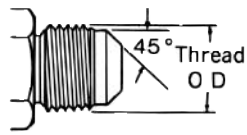

Male Half

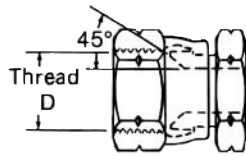

Female Half

This connection is commonly used in refrigeration, automotive and truck piping systems. The connector is frequently made of brass. Both the male and female connectors have 45° seats. The seal takes place between the male flare between the male flare the female cone seat.

The threads hold the connection mechanically. CAUTION: In the -02, -03, -04, -05, -08 and -10 sizes, the threads of the SAE 45° flare and the SAE 37° flare are the same. However, the sealing surface angles are not the same.

Inch Size	Dash size	Nominal Thread size	Male Thread O.D. inch		Female Thread O.D. inch	
			fraction	decimal	fraction	decimal
1/8	02	5/16-24	5/16	0.31	9/32	0.27
3/16	03	3/8-24	3/8	0.38	11/32	0.34
1/4	04	7/16-20	7/16	0.44	13/32	0.39
5/16	05	1/2-20	1/2	0.50	15/32	0.45
3/8	06	5/8-18	5/8	0.63	9/16	0.57
1/2	08	3/4-16	3/4	0.75	11/16	0.69
5/8	10	7/8-14	7/8	0.88	13/16	0.81
3/4	12	1 1/16-14	1 1/16	1.06	1	0.99
7/8	14	1 1/4-12	1 1/4	1.25	1 5/32	1.16
1	16	1 3/8-12	1 3/8	1.38	1 9/32	1.29

Staplok (SAE J1467)

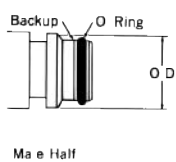

Male Half

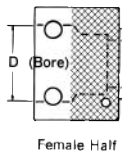

Female Half

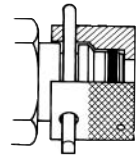

Staplok™ Connected

This is a radial O-Ring seal connection developed in Germany and commonly used for hydraulic application in underground mines. The male contains an exterior O-Ring and backup ring, plus a groove to accept the "staple". The female has a smooth bore with two holes

for the staple. A "U" shaped retaining clip or staple is inserted through the two holes, passing through the groove in the male to lock the connection together. The seal takes place by contact between the O-Ring in the male and the smooth bore of the female.

Inch Size	Dash size	Nominal Thread size	Male Thread O.D. inch		Female Thread O.D. inch	
			fraction†	decimal	fraction	decimal
1/4	04		9/32	.586	1 9/32	.597
3/8	06		25/32	.783	51/64	.794
1/2	08		15/16	.940	61/64	.951
3/4	12		1 9/64	1.137	1 9/64	1.148
1	16		1 17/32	1.529	1 35/64	1.540
1 1/4	20		1 13/16	1.806	1 13/16	1.817
1 1/2	24		2 5/32	2.163	2 11/64	2.174
2	32		2 33/64	2.517	2 17/32	2.528

†Measure to the closest 1/64-inch.

SAE J518 4-Bolt Flange*

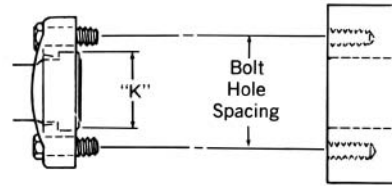

Male Half

Female Half

This connection is commonly used in fluid power systems. There are two pressure ratings. Code 61 is referred to as the "standard" series and Code 62 is the "6000 psi" series. The design concept for both series is the same, but the bolt hole spacing and flanged head diameters are larger for the higher pressure, Code 62 connection.

The female (port) is an unthreaded hole with four bolt holes in a rectangular pattern around the port. The male con-

sists of a flanged head, grooved for an O-Ring, and either a captive flange or split flange halves with bolt holes to match the port. The seal takes place on the O-Ring, which is compressed between the flanged head and the flat surface surrounding the port. The threaded bolts hold the connection together.

*SAE J518, JIS B 8363, ISO/DIS 6162 and DIN 20066 are interchangeable, except for bolt sizes.

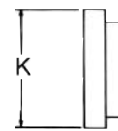
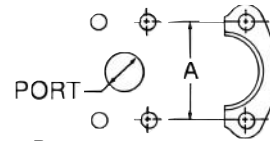

Inch Size (Dash size)	Port Hole I.D. inch fract. (deci.)	Bolt Dimension inch		Bolt Hole Spacing "A" inch (decimal)		Flanged Head Dia. "K" inch (dec)	
		Cd. 61	Cd. 62	Cd. 61	Cd.62	Cd. 61	Cd. 62
1/2 (08)	1/2 (1.50)	5/16-18x1 1/4	5/16-18x1 1/4	1 1/2 (1.50)	1 19/32 (1.59)	1 3/16 (1.19)	1 1/4 (1.25)
3/4 (12)	3/4 (1.75)	3/8-16x1 1/4	3/8-16x1 1/2	1 7/8 (1.88)	2 (2.00)	1 1/2 (1.50)	1 5/8 (1.63)
1 (16)	1 (1.00)	3/8-16x1 1/4	7/16-14x1 3/4	2 1/16 (2.06)	2 1/4 (2.25)	1 3/4 (1.75)	1 7/8 (1.88)
1 1/4 (20)	1 1/4 (1.25)	7/16-14x1 1/2	1/2-13x1 3/4	2 5/16 (2.31)	2 5/8 (2.63)	2 (2.00)	2 1/8 (2.13)
1 1/2 (24)	1 1/2 (1.50)	1/2-13x1 1/2	5/8-11x2 1/4	2 3/4 (2.75)	3 1/8 (3.12)	2 3/8 (2.38)	2 1/2 (2.50)
2 (32)	2 (2.00)	1/2-13x1 1/2	3/4-10x2 3/4	3 1/16 (3.06)	3 13/16 (3.81)	2 13/16 (2.81)	3 1/8 (3.12)

How to Measure

Four Bolt Flange—First measure the port hole diameter using the caliper. Next, measure the longest bolt hole spacing from center-to-center (Dimension "A") or measure the flanged head diameter.

ISO connections

ISO/DIS 6162 4-Bolt Flange*

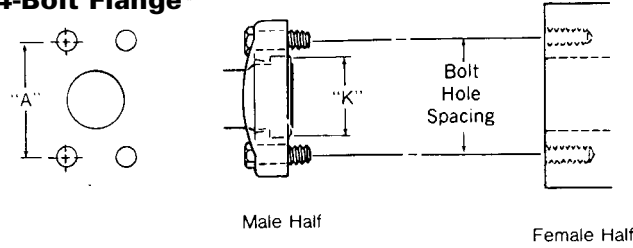

This connection is commonly used in fluid power systems. There are two pressure ratings. PN 35/350 bar (Code 61) is the "standard" series and PN 415 bar (Code 62) is the high pressure series. The design concept for both series is the same, but the bolt hole spacing and flanged head diameters are larger for the higher pressure, PN 415 bar connection. Both metric and inches bolts are used. The port will have an "M" stamped on it if metric bolts are required.

The female (port) is an unthreaded hole with four bolt holes in a rectangular pattern around the port. The male consists of a flanged head, grooved for an O-Ring, and either a captive flange or split flange halves with bolt holes to match the port. The seal takes place on the O-Ring, which is compressed between the flanged head and the flat surface surrounding the port. The threaded bolts hold the connection together.

*ISO/DIS 6162, DIN 20066, JIS B 8363 and SAE J518 are interchangeable, except for bolt sizes.

Size	Port Hole	Bolt Dimensions Spacing		Bolt Hole "A"	
		PN 35/350 Bar (Cd.61)	PN 415 Bar (Cd. 62)	PN 35/350 Bar (Cd. 61)	PN 415 Bar (Cd. 62)
mm					
in [dash]	mm [in]	mm [in]	mm [in]	mm [in]	mm [in]
13 (1/2) [08]	12,7 [.50]	M8 x 1.25 x 30 [5/16-18 x 1 1/4]	M8 x 1.25 x 30 [5/16-18 x 1 1/4]	38.10 [1.50]	40.49 [1.57]
19 (3/4) [12]	19,1 [.75]	M10 x 1.5 x 35 [3/8-16 x 1 1/4]	M10 x 1.5 x 40 [3/8-16 x 1 1/2]	47.63 [1.88]	50.80 [2.00]
25 (1) [16]	25,4 [1.00]	M10 x 1.5 x 35 [3/8-16 x 1 1/4]	M12 x 1.75 x 45 [7/16-14 x 1 3/4]	52.37 [2.06]	57.15 [2.25]
32 (1 1/4) [20]	31,8 [1.25]	M12 x 1.75 x 40 [7/16-14 x 1 1/2]	M14 x 2 x 50 [1 1/2-13 x 1 3/4]	58.72 [2.31]	66.68 [2.63]
38 (1 1/2) [24]	38,1 [1.50]	M14 x 2 x 40 [1 1/2-13 x 1 1/2]	M16 x 2 x 55 [5/8-11 x 2 1/4]	[2.75]	[3.13]
51 (2) [32]	50,8 [2.00]	M14 x 2 x 40 [1 1/2-13 x 1 1/2]	M20 x 2.5 x 70 [3/4-10 x 2 3/4]	77.77 [3.06]	96.82 [3.81]

Inch Size	Flanged Head Dia. "K"			
	PN 35/350 Bar (Cd.61)		PN 415 Bar (Cd. 62)	
	mm	in	mm	in
1/2	30.18	1.19	31.75	1.25
3/4	38.10	1.50	41.28	1.63
1	44.45	1.75	47.63	1.88
1 1/4	50.80	2.00	53.98	2.13
1 1/2	60.33	2.38	63.50	2.50
2	71.42	2.81	79.38	3.13

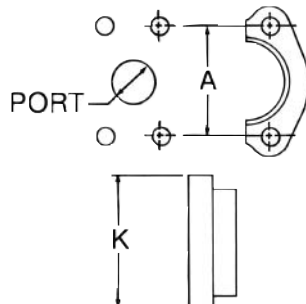

German Connections

DIN 7631 Series

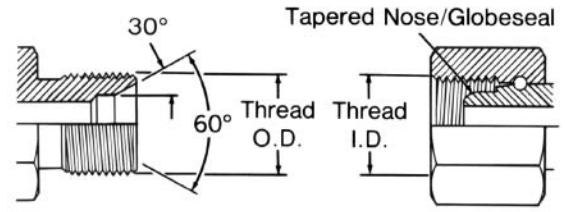

Male half dimensionally equal to DIN 7631

Female half mates with DIN 7631

This connection is frequently used in hydraulic systems. The male has a straight metric thread and a 60° (included angle) recessed cone. The female has a straight thread and a tapered nose/Globeseal

seat. The seal takes place by contact between the cone of the male and the nose of the tapered nose/Globeseal flareless swivel. The threads hold the connection mechanically.

Use With Pipe/Tube O.D.		Metric Thread Size	Male Thread O.D.		Female Thread I.D.	
mm	in		mm	in	mm	in
6	0.24	M12 x 1.5	12	0.47	10,5	0.41
8	0.32	M14 x 1.5	14	0.55	12,5	0.49
10	0.39	M16 x 1.5	16	0.63	14,5	0.57
12	0.47	M18 x 1.5	18	0.71	16,5	0.65
15	0.59	M22 x 1.5	22	0.87	20,5	0.81
18	0.71	M26 x 1.5	26	1.02	24,5	0.96
22	0.87	M30 x 1.5	30	1.18	28,5	1.12
28	1.10	M38 x 1.5	38	1.50	36,5	1.44
35	1.38	M45 x 1.5	45	1.77	43,5	1.71
42	1.65	M52 x 1.5	52	2.04	50,5	1.99

DIN 3902 Series

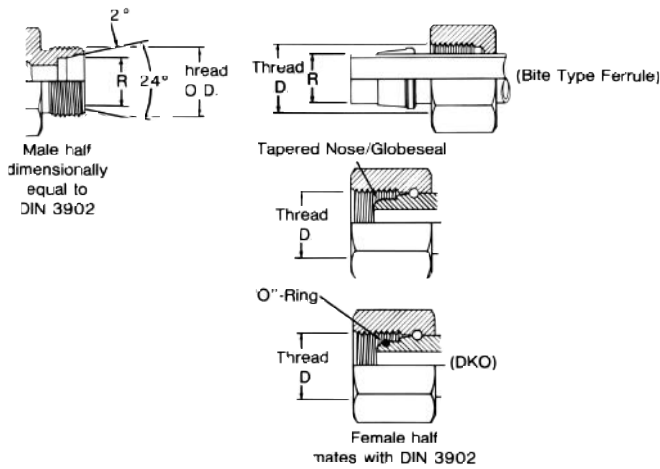

This connection style consists of a common male and three different female halves.

The male has a straight metric thread, a 24° included angle and a recessed counterbore that matches the tube O.D. used with it. The female may

be a tube, nut and ferrule, a tapered nose/Globeseal flareless swivel or a tapered nose/Globeseal flareless swivel with an O-Ring in the nose (DKO type).

Tube O.D. "R" Dim. I.Rh.*		Tube O.D. "R" Dim. s.Rh.†		Metric Thread Size	Male Thread O.D.		Female Thread I.D.	
mm	in.	mm	in.		mm	in.	mm	in.
6	0.24			M12 x 1.5	12	0.47	10.5	0.41
8	0.32	6	0.24	M14 x 1.5	14	0.55	12.5	0.49
10	0.39	8	0.32	M16 x 1.5	16	0.63	14.5	0.57
12	0.47	10	0.39	M18 x 1.5	18	0.71	16.5	0.65
12	0.47			M20 x 1.5	20	0.78	18.5	0.73
15	0.59	14	0.55	M22 x 1.5	22	0.87	20.5	0.81
16	0.63			M24 x 1.5	24	0.94	22.5	0.89
18	0.71			M26 x 1.5	26	1.02	24.5	0.96
22	0.87	20	0.78	M30 x 2.0	30	1.18	28	1.11
28	1.10	25	0.98	M36 x 2.0	36	1.41	34	1.34
30	1.18			M42 x 2.0	42	1.65	40	1.57
35	1.38			M45 x 2.0	45	1.77	43	1.70
42	1.65	38	1.50	M52 x 2.0	52	2.04	50	1.97

*I.Rh. is a light duty system.
†s.Rh. is a heavy duty system.

DIN 20066 4-Bolt Flange*

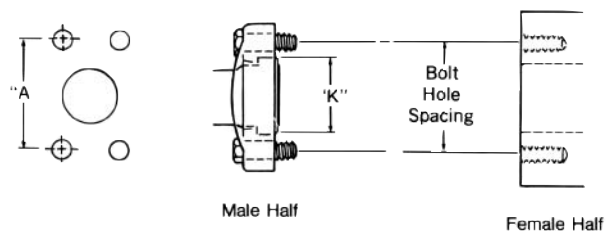

This connection is commonly used in fluid power systems. There are two pressure ratings. Form R (Code 61) is referred to as the "standard duty" series and Form S (Code 62) is the "heavy duty" series. The design concept for both series is the same, but the bolt hole spacing and flanged head diameters are larger for the higher pressure, Form S connection. Both metric and inch bolts are used.

The female (port) is an unthreaded hole with four bolt holes in a rectangular pattern around the port. The male consists of a flanged head, grooved for an O-Ring, and either a captive flange or split flange halves with bolt holes to match the port. The seal takes place on the O-Ring, which is compressed between the flanged head and the flat surface surrounding the port. The threaded bolts hold the connection together.

*DIN 20066, IS/DIS 6166, JIS B 8363 and SAE J518 are interchangeable, except for bolt sizes.

Size mm (inch) [dash]	Port Hole	Bolt Dimensions		Bolt Hole Spacing	
		Form R (Cd. 61)	Form S (Cd. 62)	Form R (Cd. 61)	Form S (Cd. 62)
	mm (in)			mm (in)	mm (in)
12 (1/2) [08]	12.7 (.50)	M8 x 1.25 x 30 5/16-18 x 1 1/4	M8 x 1.25 x 30 5/16-18 x 1 1/4	38.10 (1.50)	40.49 (1.57)
20 (3/4) [12]	19.1 (.75)	M10 x 1.5 x 30 3/8-16 x 1 1/4	M10 x 1.5 x 40 3/8-16 x 1 1/2	47.63 (1.88)	50.80 (2.00)
25 (1) [16]	25.4 (1.00)	M10 x 1.5 x 35 3/8-16 x 1 1/4	M12 x 1.75 x 45 7/16-14 x 1 3/4	52.37 (2.06)	57.15 (2.25)
32 (1 1/4) [20]	31.7 (1.25)	M10 x 1.75 x 40 7/16-14 x 1 1/2	M14 x 2 x 45 1/2-13 x 1 3/4	58.72 (2.31)	66.68 (2.63)
40 (1 1/2) [24]	38.0 (1.50)	M12 x 1.75 x 40 1/2-13 x 1 1/2	M16 x 2 x 55 5/8-11 x 2 1/4	69.85 (2.75)	79.38 (3.13)
50 (2) [32]	50.8 (2.00)	M12 x 1.75 x 40 1/2-13 x 1 1/2	M20 x 2.5 x 70 3/4-10 x 2 3/4	77.77 (3.06)	96.82 (3.81)

Inch Size	Flanged Head Dia. "K"			
	FORM R (Cd. 61)		FORM S (Cd. 62)	
	mm	in.	mm	in.
1/2	30.18	1.19	31.75	1.25
3/4	38.10	1.50	41.28	1.63
1	44.45	1.75	47.63	1.88
1 1/4	50.80	2.00	53.98	2.13
1 1/2	60.33	2.38	63.50	2.50
2	71.42	2.81	79.38	3.13

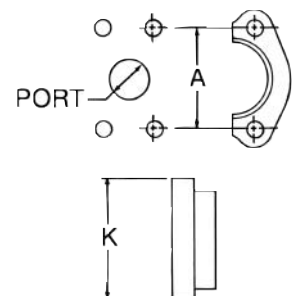

**DIN 3852
Male Connectors
and Female Ports**

DIN 3852 Metric Threads

Metric Thread	Male Thread O.D. "A"		Female Thread I.D. "B"	
	mm	in.	mm	in.
M12 x 1.5	12	0.47	10,5	0.41
M14 x 1.5	14	0.55	12,5	0.49
M16 x 1.5	16	0.63	14,5	0.57
M18 x 1.5	18	0.71	16,5	0.65
M20 x 1.5	20	0.78	18,5	0.73
M22 x 1.5	22	0.87	20,5	0.81
M24 x 1.5	24	0.94	22,5	0.89
M26 x 1.5	26	1.02	24,5	0.96
M27 x 2	27	1.06	25	0.98
M30 x 1.5	30	1.18	28,5	1.12
M30 x 2	30	1.18	28	1.10
M33 x 2	33	1.30	31	1.22
M36 x 1.5	36	1.41	34,5	1.36
M36 x 2	36	1.41	34	1.33
M38 x 1.5	38	1.49	36,5	1.43
M38 x 2	38	1.49	36	1.41
M42 x 1.5	42	1.65	40,5	1.60
M42 x 2	42	1.65	40	1.57
M45 x 1.5	45	1.77	43,5	1.71
M45 x 2	45	1.77	43	1.69
M48 x 1.5	48	1.89	46,5	1.83
M48 x 2	48	1.89	46	1.81
M52 x 1.5	52	2.04	50,5	1.89
M52 x 2	52	2.04	50	1.97

For DIN 3852 Whitworth pipe thread dimensions, see BSPT/BSPP dimensions. They are the same.

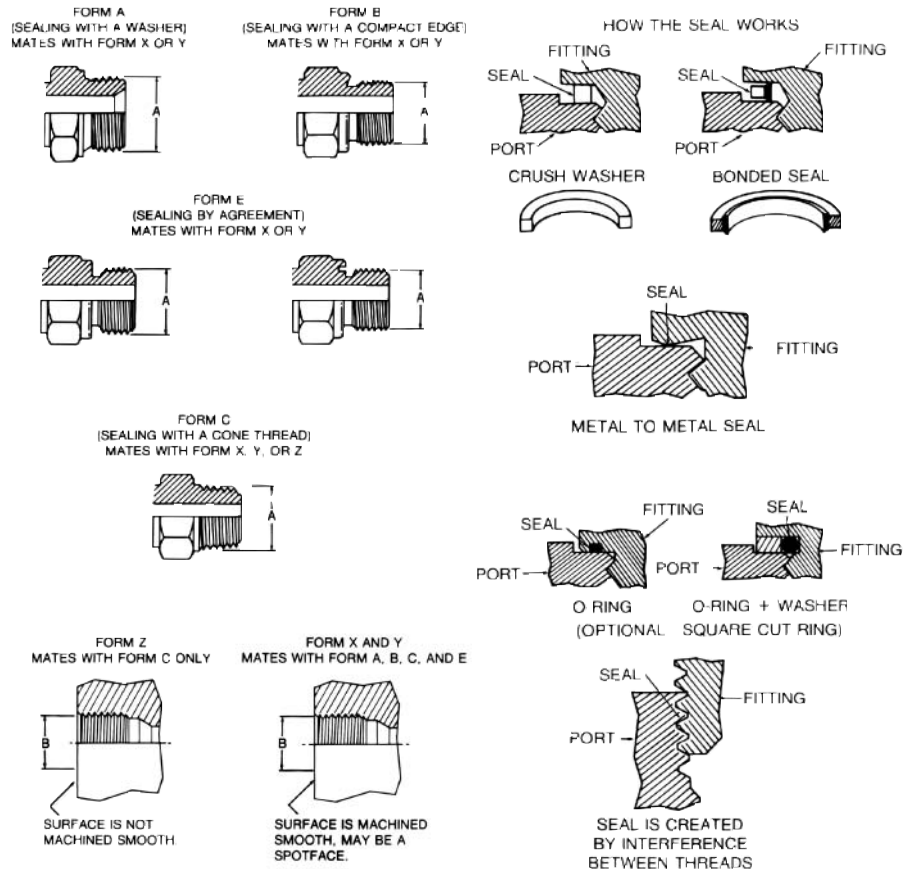

SPECIALTY & TRUCK HOSE

LOW & MEDIUM PRESSURE HOSE

HIGH PRESSURE HOSE

HOSE FITTINGS

ADAPTERS & TUBE FITTINGS

ACCESSORIES & ASSEMBLY INSTRUCTIONS

HOSE ASSEMBLY EQUIPMENT

APPENDICES

French Connections

Millimetrique and GAZ Series

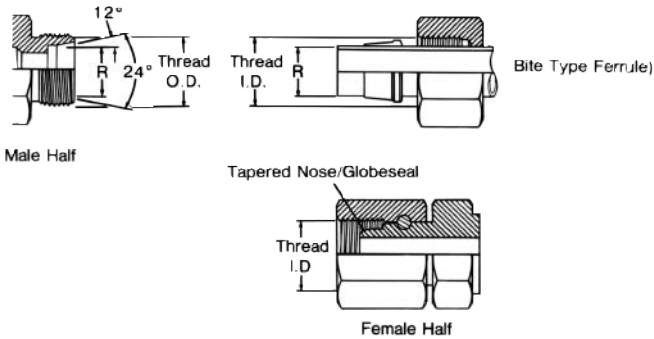

This connection consists of a common male and two different females. The Millimetrique Series is used with whole

number metric O.D. tubing and the GAZ Series is used with fractional number metric O.D. pipe size tubing.

Millimetrique and GAZ Threads

Tubing O.D. "R" dim.		"Gaz" Pipe O.D. "R" dim.		Metric Thread size	Male Thread O.D.		Female Thread I.D.	
mm	in	mm	in		mm	in	mm	in
6	0.24			M12 x 1.5	12	0.47	11	0.43
8	0.32			M14 x 1.5	14	0.55	12.5	0.49
10	0.39			M16 x 1.5	16	0.63	14.5	0.57
12	0.47			M18 x 1.5	18	0.71	16.5	0.65
14	0.55	13.25	0.52	M20 x 1.5	20	0.78	18.5	0.73
15	0.59			M22 x 1.5	22	0.87	20.5	0.81
16	0.63	16.75	0.66	M24 x 1.5	24	0.94	22.5	0.89
18	0.71			M27 x 1.5	27	1.06	25.5	1.00
22	0.87	21.25	0.83	M30 x 1.5	30	1.18	28.5	1.12
25	0.98			M33 x 1.5	33	1.30	31.5	1.24
28	1.10	26.75	1.05	M36 x 1.5	36	1.41	34.5	1.36
30	1.18			M39 x 1.5	39	1.54	37.5	1.48
32	1.25			M42 x 1.5	42	1.65	40.5	1.60
35	1.38	33.50	1.32	M45 x 1.5	45	1.77	43.5	1.71
38	1.50			M48 x 1.5	48	1.89	46.5	1.83
40	1.57	42.25	1.66	M52 x 1.5	52	2.04	50.5	1.99
45	1.77			M54 x 2.0	54	2.12	52	2.05
		48.25	1.90	M58 x 2.0	58	2.28	55	2.16

British Connections

British Standard Pipe (BSP)

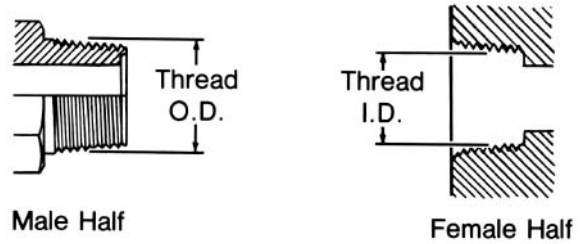

This BSPT (tapered) connection is similar to the NPT, except that the thread pitches are different in most sizes, and the thread form and O.D.s are

close but not the same. Sealing is accomplished by thread distortion. A thread sealant is recommended.

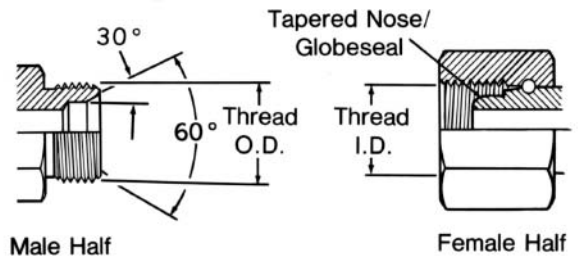

The BSP (parallel) male is similar to the NPSM male except the thread pitches are different in most sizes.

The female swivel BSPP has a tapered nose/Globeseal flareless swivel which seals on the cone seat of the male.

BSPT/BSPP Threads

Inch Size	Dash size	Nominal Thread size	Male Thread O.D. Inch		Female Thread O.D. Inch	
			fraction	decimal	fraction	decimal
1/8	02	1/8-28	3/8	0.38	11/32	0.35
1/4	04	1/4-19	33/64	0.52	15/32	0.47
3/8	06	3/8-19	21/32	0.65	19/32	0.60
1/2	08	1/2-14	113/16	0.82	3/4	0.75
5/8	10	5/8-14	7/8	0.88	13/16	0.80
3/4	12	3/4-14	11/32	1.04	31/32	0.97
1	16	1-11	15/16	1.30	17/32	1.22
1 1/4	20	1 1/4-11	121/32	1.65	19/16	1.56
1 1/2	24	1 1/2-11	17/8	1.88	125/32	1.79
2	32	2-11	211/32	2.35	2 1/4	2.26

*Frequently, the thread size is expressed as a fractional dimension preceded by the letter "G" or the letter "R". The "G" represents a parallel thread and the "R" indicates a tapered thread. For example, BSPP 3/8-19 may be expressed as G 3/8, and BSPT 3/8-19 may be expressed as R3/8.

JIS 30° Male Inverted Seat, Parallel Pipe Threads

(Threads per JIS B 0202)

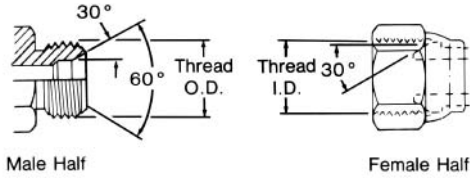

The JIS parallel is similar to the BSPP connection. The JIS parallel thread and the BSPP connection are interchangeable.

Size	Size (dash)	Nominal Thd. Size (similar to bspp)	Male Thread O.D.		Female Thread I.D.	
			fraction	mm	fraction	mm
1/4	6 (04)	1/4-19	33/64	13.2	15/32	11.9
3/8	9 (06)	3/8-19	21/32	16.7	19/32	15.3
1/2	12 (08)	1/2-14	13/16	21.0	3/4	19.2
3/4	19 (12)	3/4-14	11/32	26.4	31/32	24.6
1	25 (16)	1-11	15/16	33.3	17/32	30.9
1 1/4	32 (20)	1 1/4-11	121/32	41.9	19/16	39.6
1 1/2	38 (24)	1 1/2-11	17/8	47.8	125/32	45.5
2	50 (32)	2-11	211/32	59.7	2 1/4	57.4

JIS 30° Male (Inverted) Seat, Metric Threads

(Threads per JIS B 0207)

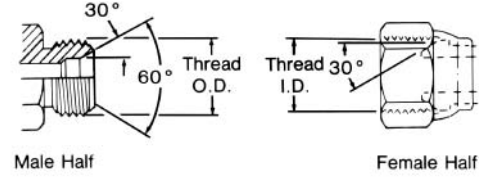

The JIS parallel (metric) is the same as the JIS parallel (PF), except for the thread difference.

Inch Size	Dash Size Equivalent	Thread Size	Male Thread O.D.		Female Thread I.D.	
			fraction	mm	fraction	mm
6	04	M14 x 1.5	14	0.55	12.5	0.49
9	06	M18 x 1.5	18	0.71	16.5	0.65
12	08	M22 x 1.5	22	0.87	20.5	0.81
19	12	M30 x 1.5	30	1.18	28.5	1.12
25	16	M33 x 1.5	33	1.30	31.5	1.24
32	20	M42 x 1.5	42	1.65	40.5	1.60

JIS Tapered Pipe (PT)

(Threads per JIS B 0203)

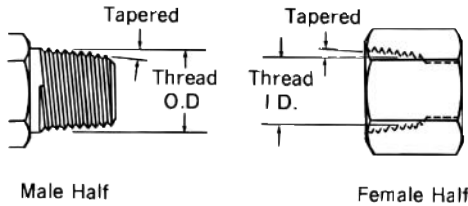

The JIS tapered thread is similar to the BSPT connection in design, appearance and

dimensions. The JIS tapered thread and the BSPT connection are interchangeable.

Size	Size (dash)	Nominal Thd. Size (similar to bspt)	Male Thread O.D.		Female Thread I.D.	
			fraction	mm	fraction	mm
1/4	6 (04)	1/4-19	33/64	13.2	15/32	11.9
3/8	9 (06)	3/8-19	21/32	16.7	19/32	15.3
1/2	12 (08)	1/2-14	13/16	21.0	3/4	19.2
3/4	19 (12)	3/4-14	11/32	26.4	31/32	24.6
1	25 (16)	1-11	15/16	33.3	17/32	30.9
1 1/4	32 (20)	1 1/4-11	121/32	41.9	19/16	39.6
1 1/2	38 (24)	1 1/2-11	17/8	47.8	125/32	45.5
2	50 (32)	2-11	211/32	59.7	2 1/4	57.4

JIS 30° Female (Cone) Seat, Parallel Pipe Threads

(Threads per JIS B 0202)

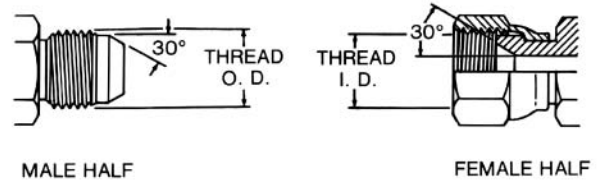

The Japanese JIS 30° flare is similar to the American SAE 37° flare connection in application as well as sealing princi-

ples. However, the flare angle and dimensions are different. The threads are similar to BSPP.

Size	Size (dash)	Nominal Thd. Size (similar to bspp)	Male Thread O.D.		Female Thread I.D.	
			fraction	mm	fraction	mm
1/4	6 (04)	1/4-19	33/64	13.2	15/32	11.9
3/8	9 (06)	3/8-19	21/32	16.7	19/32	15.3
1/2	12 (08)	1/2-14	13/16	21.0	3/4	19.2
3/4	19 (12)	3/4-14	11/32	26.4	31/32	24.6
1	25 (16)	1-11	15/16	33.3	17/32	30.9
1 1/4	32 (20)	1 1/4-11	121/32	41.9	19/16	39.6
1 1/2	38 (24)	1 1/2-11	17/8	47.8	125/32	45.5
2	50 (32)	2-11	211/32	59.7	2 1/4	57.4

JIS B 8363 4-Bolt Flange*

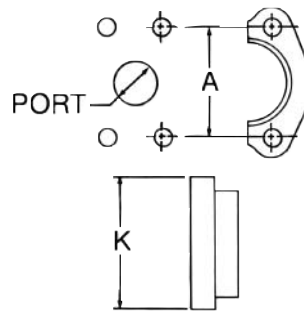
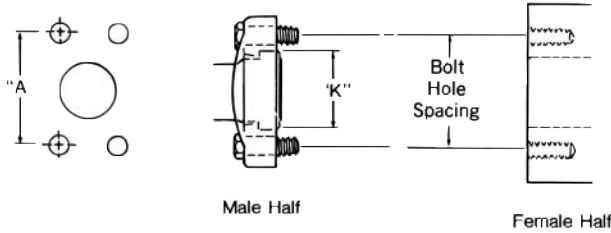

Inch size	Flanged Head dia. "K"			
	Type I Bar (Cd.61)		Type II Bar (Cd. 62)	
	mm	in	mm	in
1/2	30,18	1.19	31,75	1.25
3/4	38,10	1.50	41,28	1.63
1	44,45	1.75	47,63	1.88
1 1/4	50,80	2.00	53,98	2.13
1 1/2	60,33	2.38	63,50	2.50
2	71,42	2.81	79,38	3.13

This connection is commonly used in fluid power systems. There are two pressure ratings. Type I (Code 61) is referred to as the "standard" series and Type II (Code 62) is the "6000 psi" series. The design concept for both series is the same, but the bolt hole spacing and flanged head diameters are larger for the higher pressure, Type II connection. Both metric and inch bolts are used.

The female (port) is an unthreaded hole with four bolt holes in a rectangular pattern around the port. The male consists of a flanged head, grooved for an O-Ring, and either a captive flange or split flange halves with bolt holes to match the port. The seal takes place on the O-Ring, which is compressed between the flanged head and the flat surface surrounding the port. The threaded bolts hold the connection together.

*JIS B 8363, ISO/DIS 6162, DIN 20066, and SAE J518 are interchangeable, except for bolt sizes.

Size mm Inch [dash]	Port Hole mm (inch)	Bolt Dimensions mm & inch		Bolt Hole Spacing "A" mm (inch)	
		TYPE I (Cd.61)	TYPE II (Cd. 62)	TYPE I (Cd. 61)	TYPE II (Cd. 62)
12 (1/2) [08]	12.7 (0.50)	M8 x 1.25 x 30 5/16-18 x 1 1/4	M8 x 1.25 x 30 5/16-18 x 1 1/4	38.10 (1.50)	40.49 (1.57)
19 (3/4) [12]	19.1 (0.75)	M10 x 1.5 x 30 3/8-16 x 1 1/4	M10 x 1.5 x 40 3/8-16 x 1 1/2	47.63 (1.88)	50.80 (2.00)
25 (1) [16]	25.4 (1.00)	M10 x 1.5 x 30 3/8-16 x 1 1/4	M12 x 1.75 x 45 7/16-14 x 1 3/4	52.37 (2.06)	57.15 (2.25)
32 (1 1/4) [20]	31.7 (1.25)	M12 x 1.5 x 40 7/16-14 x 1 1/2	M14 x 2 x 45 1/2-13 x 1 3/4	58.72 (2.31)	66.68 (2.63)
38 (1 1/2) [24]	38.0 (1.50)	M12 x 1.75 x 40 1/2-13 x 1 1/2	M16 x 2 x 55 5/8-11 x 2 1/4	69.85 (2.75)	79.38 (3.13)
50 (2) [32]	50.8 (2.00)	M12 x 1.75 x 40 1/2-13 x 1 1/2	M20 x 2.5 x 70 3/4-10 x 2 3/4	77.77 (3.06)	96.82 (3.81)

JIS 210 Kgf/cm² 4-Bolt Square Flange

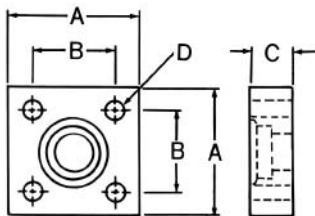

The JIS 4-Bolt square flange connection is similar in concept to the SAE 4-bolt flange connection, except that the JIS bolt pattern is square and the flange itself is different.

Size mm	Approx. inch size	Bolt Size mm (Bolt length for long design)	Dim. "A" mm (inch)	Dim. "B" mm (inch)	Dim. "C" mm (inch)	Bolt Hole Dia "D" mm (inch)
12	1/2	M10 x 1.5 x 55 (80)	63 (2.48)	40 (1.57)	22 (0.87)	11 (0.43)
19	3/4	M10 x 1.5 x 55 (80)	68 (2.67)	45 (1.77)	22 (0.87)	11 (0.43)
25	1	M12 x 1.75 x 70 (100)	80 (3.15)	53 (2.09)	28 (1.10)	13 (0.51)
32	1 1/4	M12 x 1.75 x 70 (100)	90 (3.54)	63 (2.48)	28 (1.10)	13 (0.51)
38	1 1/2	M16 x 2.0 x 90 (130)	100 (3.94)	70 (2.76)	36 (1.42)	18 (0.71)
50	2	M16 x 2.0 x 90 (130)	112 (4.41)	80 (3.15)	36 (1.42)	18 (0.71)

JIS 210 Kgf/cm² O-Ring

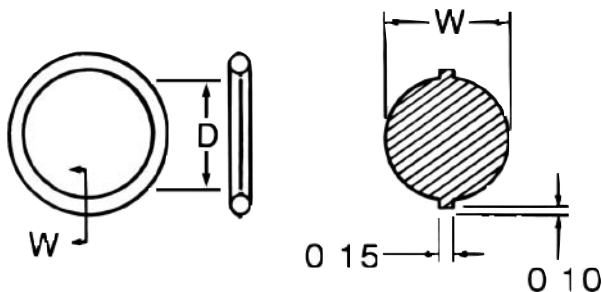

Nominal size mm	Dim. "D" mm	Dim. "W" mm
12	24.4 ± 0.15	3.1 ± 0.1
19	29.4 ± 0.15	3.1 ± 0.1
25	34.4 ± 0.15	3.1 ± 0.1
32	39.4 ± 0.15	3.1 ± 0.1
38	49.4 ± 0.15	3.1 ± 0.1
50	59.4 ± 0.15	3.1 ± 0.1

How to Identify O-Ring Pilot Thread Sizes

This connection is common to air conditioning systems, both in vehicle and commercial applications. Both the male and female halves of the connections have a pilot, either long or short. The seal takes place by compressing an O-ring adjacent to the bead of the tube. The threads hold the connection together mechanically.

Inch Size	Dash Size	Male Thread			Female Thread		
		O.D. (inch) Nominal Thread	O.D. (inch) Fraction	O.D. (inch) Decimal	I.D. (inch) Nominal Thread	I.D. (inch) Fraction	I.D. (inch) Decimal
3/8	06	5/8 - 18	5/8	0.62	5/8 - 18	9/16	0.57
1/2	08	3/4 - 18	3/4	0.75	3/4 - 16	11/16	0.69
5/8	10	7/8 - 18	7/8	0.87	7/8 - 14	13/16	0.81
3/4	12	1 1/16 - 16	1 1/16	1.06	1 1/16 - 14	1	0.99

Inch Size	Nominal Tube Size	Long Pilot		Short Pilot	
		Bead O.D. (inch)	Pilot Length	Bead O.D. (inch)	Pilot Length
3/8	06	0.52	0.28	0.52	0.19
1/2	08	0.64	0.39	0.64	0.19
5/8	10	0.77	0.39	0.77	0.19
3/4	12	0.91	0.39	0.91	0.19

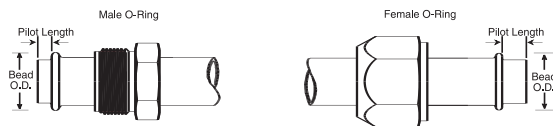

Thread Engagement Nominal Dimensions

Dimensions may vary due to tolerance conditions. Listed below are the thread engagement dimensions (B) which must be taken into consideration when making connection with ports or appropriate female adapters. The "B" dimension must be subtracted from the overall length (A) to insure proper connection.

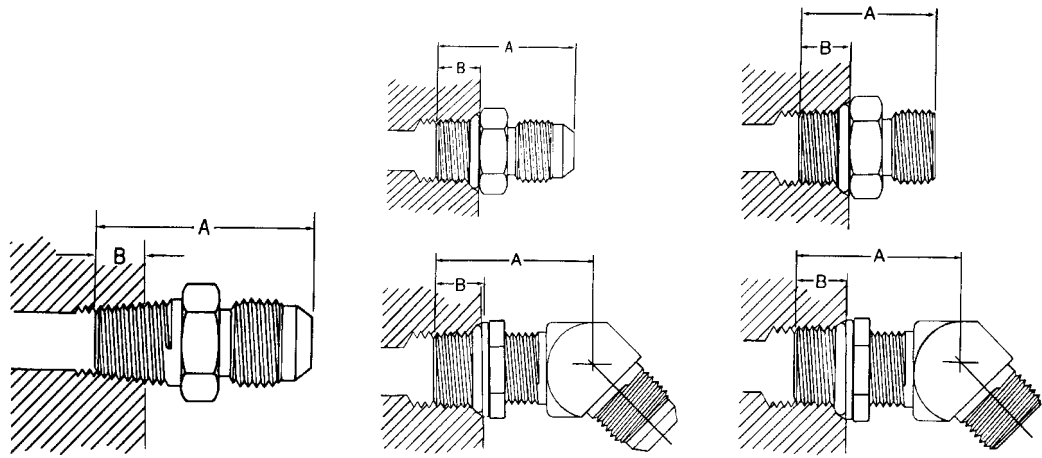

Dash Size	Male Pipe		SAE O-ring Boss SAE J1926 with 37° Flare J514		SAE O-ring Boss SAE J1926 with ORS J1453	
	Straight and Angled Dimension "B"		Straight and Adjustable Dimension "B"		Straight and Adjustable Dimension "B"	
	mm	in	mm	in	mm	in
-02	6,4	0.25				
-04	9,7	0.38	9,1	0.36	10,9	0.43
-05			9,1	0.36	10,9	0.43
-06	9,7	0.38	9,1	0.39	11,9	0.47
-08	12,7	0.50	10,9	0.43	14,0	0.55
-10			12,7	0.50	16,0	0.63
-12	15,7	0.62	15,0	0.59	18,5	0.73
-14			15,0	0.59		
-16	17,5	0.69	15,0	0.59	18,5	0.73
-20	17,5	0.69	15,0	0.59	18,5	0.73
-24	17,5	0.69	15,0	0.59	18,5	0.73
-32	19,1	0.75	15,0	0.59		

Allowable bulkhead thickness for ORS:

Dash Size	Hole Diameter	ORS Bulkhead Thickness			
		MIN		MAX	
		mm	in	mm	in
-04	.575 +.015/-0.000	5,1	0.20	12,7	0.50
-06	.700 +.015/-0.000	5,1	0.20	15,0	0.59
-08	.825 +.015/-0.000	5,6	0.22	15,0	0.59
-10	1.015 +.015/-0.000	5,8	0.23	15,0	0.59
-12	1.200 +.015/-0.000	6,4	0.25	15,0	0.59
-16	1.450 +.015/-0.000	6,4	0.25	15,2	0.60
-20	1.715 +.015/-0.000	6,4	0.25	15,2	0.60
-24	2.030 +.015/-0.000	6,4	0.25	15,2	0.60

For 37° Flare:

Dash Size	Hole Diameter	37° Bulkhead Thickness Straights				37° Bulkhead Thickness Shapes			
		MIN		MAX		MIN		MAX	
		mm	in	mm	in	mm	in	mm	in
-03	.391 +.016/-0.000	1,3	0.05	10,4	0.41	3,3	0.13	6,4	0.25
-04	.453 +.016/-0.000	1,3	0.05	10,4	0.41	3,3	0.13	7,1	0.28
-05	.516 +.016/-0.000	1,3	0.05	10,4	0.41	3,3	0.13	7,1	0.28
-06	.578 +.016/-0.000	1,3	0.05	11,2	0.44	3,3	0.13	7,6	0.30
-08	.766 +.016/-0.000	1,3	0.05	11,2	0.44	4,1	0.16	8,6	0.34
-10	.891 +.016/-0.000	1,3	0.05	11,9	0.47	4,1	0.16	9,1	0.36
-12	1.076 +.016/-0.000	1,3	0.05	11,9	0.47	4,1	0.16	9,7	0.38
-16	1.328 +.016/-0.000	1,3	0.05	11,9	0.47	4,1	0.16	9,7	0.38
-20	1.656 +.031/-0.000	1,3	0.05	11,9	0.47	4,1	0.16	9,7	0.38
-24	1.906 +.031/-0.000	1,3	0.05	11,9	0.47	4,1	0.16	9,7	0.38

Dimensions may vary due to tolerance conditions.

SPECIALTY & TRUCK HOSE
 LOW & MEDIUM PRESSURE HOSE
 HIGH PRESSURE HOSE
 HOSE FITTINGS
 ADAPTERS & TUBE FITTINGS
 ACCESSORIES & ASSEMBLY INSTRUCTIONS
 HOSE ASSEMBLY EQUIPMENT
 APPENDICES

Thread Style Pressure Performance/ Maximum Operating Pressure

The following table is a breakdown of hydraulic pressure performance by thread style and size for steel products. The table is based on limited laboratory test data and is intended only as an approximate guide to field performance of Eaton products. Figures shown are maximum oper-

ating pressures in BAR (psi), based upon a 4:1 safety factor relative to the connection minimum burst pressure. Testing was conducted at SAE recommended assembly torque in hardened test blocks. The pressure rating must be adjusted for any change in mating part material. The maximum

operating pressure for the adapter or tube fitting body must be the lower of the chosen mating end types.

SPECIALTY &
TRUCK HOSE

LOW & MEDIUM
PRESSURE HOSE

HIGH PRESSURE HOSE

HOSE FITTINGS

ADAPTERS &
TUBE FITTINGS

ACCESSORIES &
ASSEMBLY INSTRUCTIONS

HOSE ASSEMBLY
EQUIPMENT

APPENDICES

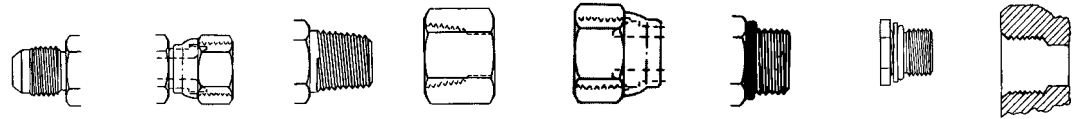

Dash Size	Inch Size	SAE100R2 Maximum Operating Pressure		SAE 37° Flare Male (JIC)		SAE 37° Flare Swivel (JIC)		Male Pipe NPTF		Female Pipe NPTF		Female Pipe Swivel NPSM		*Male O-ring Boss		*Straight Thread O-ring Adjustable		Female O-ring Boss	
		bar	psi	bar	psi	bar	psi	bar	psi	bar	psi	bar	psi	bar	psi	bar	psi	bar	psi
-2	1/8							700,0	10000	350,0	5000	420,0	6000						
-4	1/4	350,0	5000	595,0	8500	385,0	5500	655,0	9500	315,0	4500	350,0	5000	525,0	7500	315,0	4500	315,0	4500
-5	5/16	297,0	4250	595,0	8500	350,0	5000							525,0	7500	245,0	3500	245,0	3500
-6	3/8	280,0	4000	490,0	7000	280,0	4000	560,0	8000	245,0	3500	280,0	4000	525,0	7500	280,0	4000	245,0	3500
-8	1/2	245,0	3500	20,0	6000	280,0	4000	420,0	6000	245,0	3500	245,0	3500	525,0	7500	280,0	4000	210,0	3000
-10	5/8	192,0	2750	385,0	5500	210,0	3000							525,0	7500	280,0	4000	175,0	2500
-12	3/4	157,0	2250	280,0	4000	210,0	3000	350,0	5000	210,0	3000	245,0	3500	350,0	5000	245,0	3500	124,1	1800
-14	7/8	140,0	2000	280,0	4000	210,0	3000							350,0	5000	210,0	3000	117,2	1700
-16	1	140,0	2000	245,0	3500	175,0	2500	280,0	4000	175,0	2500	210,0	3000	315,0	4500	175,0	2500	112,0	1600
-20	1 1/4	113,0	1625	245,0	3500	140,0	2000	210,0	3000	140,0	2000	140,0	2000	315,0	4500	140,0	2000	105,0	1500
-24	1 1/2	87,0	1250	140,0	2000	105,0	1500	140,0	2000	105,0	1500	105,0	1500	245,0	3500	140,0	2000	105,0	1500
-32	2	78,0	1125	87,0	1250	87,0	1250	140,0	2000	98,0	1400	105,0	1500	140,0	2000				

*For non "ORS" adapters

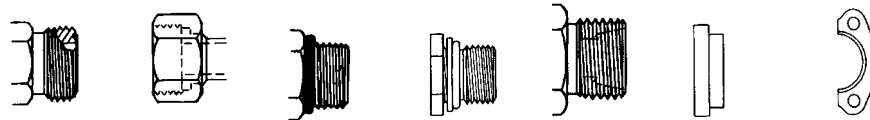

Dash Size	Inch Size	SAE100r2 Maximum Operating Pressure		ORS Male	ORS Female Swivel	For ORS Adapters ORB/STR	For ORS Adapters ORB/ADJ	Male SAE Flareless	Flange Code 61		Flange Code 62						
		bar	psi	bar	psi	bar	psi	bar	psi	bar	psi	bar	psi				
-2	1/8																
-4	1/4	350,0	5000	630,0	9000	630,0	9000	420,0	6000	420,0	6000						
-5	5/16	297,0	4250														
-6	3/8	280,0	4000	630,0	9000	630,0	9000	420,0	6000	420,0	6000						
-8	1/2	245,0	3500	630,0	9000	560,0	8000	630,0	9000	420,0	6000	350,0	5000	420,0	6000		
-10	5/8	192,0	2750	630,0	9000	560,0	8000	630,0	9000	420,0	6000	350,0	5000				
-12	3/4	157,0	2250	420,0	6000	420,0	6000	420,0	6000	315,0	4500	350,0	5000	420,0	6000		
-14	7/8	140,0	2000														
-16	1	140,0	2000	420,0	6000	420,0	6000	420,0	6000	350,0	5000	280,0	4000	350,0	5000	420,0	6000
-20	1 1/4	113,0	1625	315,0	4500	315,0	4500	315,0	4500			280,0	4000	420,0	6000		
-24	1 1/2	87,0	1250	280,0	4000	280,0	4000	280,0	4000	210,0	3000			210,0	3000	420,0	6000
-32	2	78,0	1125											210,0	3000	420,0	6000

Maximum Operating Pressures Bar/PSI for Hydraulic Tubing (SAEJ356, J524, J525, J526, J527)

Tube O.D.	Dash Size	Tubing Wall Thickness (in inches)																							
		.028		.035		.049		.065		.083		.095		.109		.120		.134		.148		.156		.188	
		bar	psi	bar	psi	bar	psi	bar	psi	bar	psi	bar	psi	bar	psi	bar	psi	bar	psi	bar	psi	bar	psi	bar	psi
.19	-03	297,0	4250	375,0	5450																				
.25	-04	213,0	3100	272,0	3950	396,0	5750	420,0	6000																
.31	-05	169,0	2450	213,0	3100	315,0	4500	420,0	6000																
.38	-06	140,0	2000	175,0	2550	251,0	3650	350,0	5000	420,0	6000	420,0	6000												
.50	-08			127,0	1850	186,0	2700	251,0	3650	335,0	4800	388,0	5550	420,0	6000	420,0	6000								
.62	-10			105,0	1500	145,0	2100	196,0	2850	258,0	3750	299,0	4350	353,0	5050	392,0	5600								
.75	-12			84,0	1200	122,0	1750	162,0	2350	210,0	3050	248,0	3550	286,0	4150	322,0	4600								
1.00	-16			62,0	900	89,0	1300	122,0	1750	157,0	2250	182,0	2600	210,0	3000	231,0	3350	262,0	3800	294,0	4200				
1.25	-20					70,0	1000	93,0	1350	122,0	1750	143,0	2050	162,0	2350	182,0	2650	189,0	2700	203,0	2950	217,0	3100	259,0	3750
1.50	-24							79,0	1150	100,0	1450	119,0	1700	134,0	1950	148,0	2150	171,0	2450	171,0	2450	182,0	2600	220,0	3150
2.00	-32							58,0	850	77,0	1100	87,0	1250	100,0	1450	112,0	1600	126,0	1800	140,0	2000	147,0	2100	178,0	2550

Maximum operating pressure ratings at specified wall thickness are based upon recommended tubing ratings per SAEJ1065 as well as limited laboratory test data. Operating pressures are based upon a

4:1 safety factor relative to tube burst data. Eaton recommends a maximum operating pressure of the joint which is the lesser of the tubing rating or the mating connector rating.

Recommended Wall Thickness (Inches) for Tube Fitting Applications

Tube	Dash	Versil-Flare SAE 37° Flare	Versil-Flare SAE 37° Flareless	ORS-BR SAE O-Ring Face Seal	ORS-TF SAE O-ring Face Seal
.19	-03	.028 – .035	.028 – .035		
.25	-04	.028 – .065	.028 – .065	.028 – .065	.028 – .065
.31	-05	.028 – .065	.028 – .065		
.38	-06	.028 – .065	.028 – .095	.035 – .083	.028 – .065
.50	-08	.035 – .083	.035 – .120	.035 – .109	.035 – .120
.62	-10	.035 – .095	.035 – .120	.035 – .120	.035 – .095
.75	-12	.035 – .109	.035 – .120	.035 – .120	.049 – .120
1.00	-16	.035 – .120	.035 – .134	.049 – .148	.049 – .134
1.25	-20	.049 – .120	.049 – .188	.049 – .188	.049 – .156
1.50	-24	.065 – .120	.065 – .188	.065 – .188	.065 – .188
2.00	-32	.065 – .134	.065 – .188		

Recommended Hydraulic Tubing Material Specifications

Hydraulic Tubing SAE Specifications

Versil-Flare SAE 37° Flare	Versil-Flare SAE 37° Flareless	ORS-BR SAE O-ring Face Seal	ORS-TF SAE O-ring Face Seal
SAEJ524	SAEJ356	SAEJ356	SAEJ356
SAEJ525	SAEJ524	SAEJ524	SAEJ524
	SAEJ525	SAEJ525	SAEJ525
	SAEJ527	SAEJ526	SAEJ526

Hydraulic tubing material description: SAEJ356 electric resistance welded flash controlled low carbon steel, SAEJ524 seamless annealed low carbon steel, SAEJ525 electric resistance welded cold worked annealed, SAEJ526

single wall welded low carbon steel (automotive), SAEJ527 brazed double wall low carbon steel (automotive). The maximum hardness of the above tubing should not exceed Rockwell B65.

Metric Thread Dimensions Conversion Adapters

Sealing is achieved by means of an O-Ring, retaining washer and a properly machined port. The O-Ring is "captured" by the I.D. of

the retaining washer. The port may be of the spot faced or a flat machined surface as long as the D6 dimension is met.

Assembly instructions for adjustable type adapters are presented on page 309.

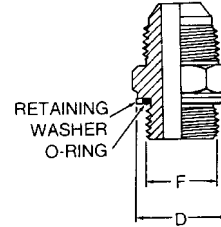
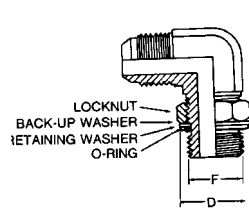

DIN 3852 LARGE SPOTFACE

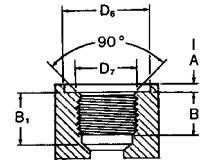

EQUIVALENT DIN 3852 FORM X

Dimensions in mm

Thread Size	M 10 x 1	M 12 x 1.5	M 14 x 1.5	M 16 x 1.5	M 18 x 1.5	M 20 x 1.5	M 22 x 1.5	M 26 x 1.5	M 27 x 2	M 33 x 2	M 42 x 2	M 48 x 2
F Thread Dia.	10.0	12.0	14.0	16.0	18.0	20.0	22.0	26.0	27.0	33.0	42.0	48.0
A max	1.0	1.5	1.5	1.5	2.0	2.0	2.5	2.5	2.5	2.5	2.5	2.5
B min (full thread)	12.0	12.0	12.0	12.0	12.0	14.0	14.0	16.0	16.0	18.0	20.0	22.0
B1 min	13.5	18.5	18.5	18.5	18.5	20.5	20.5	22.5	24.0	26.0	28.0	30.0
D max	15.7	18.7	19.7	23.2	26.2	28.2	30.2	35.2	36.2	43.2	52.7	58.7
D6 min	16.2	19.2	20.2	23.7	26.9	28.9	30.7	35.7	36.7	44.4	53.4	59.9
D7 max	10.2	12.2	14.2	16.2	18.2	20.2	22.2	26.2	27.2	33.3	42.3	48.3

BSPP (Parallel) Threads

Sealing is achieved by means of an O-Ring, retaining washer and a properly machined port.

The O-Ring is "captured" by the I.D. of the retaining washer. The compression is controlled by the thickness of the retaining washer.

The port may be of the spot faced or a flat machined surface as long as the D6 dimension is met.

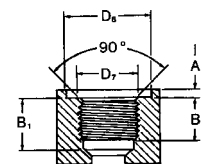
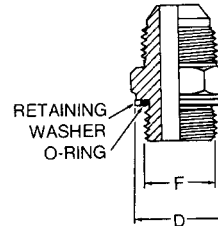
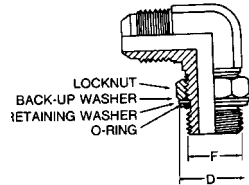

Thread Size	G 1/8"-28		G 1/4"-19		G 3/8"-19		G 1/2"-14		G 3/4"-14		G 1"-11		G 1 1/4"-11		G 1 1/2"-11	
	mm	in	mm	in	mm	in	mm	in	mm	in	mm	in	mm	in	mm	in
F Thread Dia.	9,7	0.38	13,2	0.50	16,7	0.66	20,9	0.83	26,4	1.04	33,3	1.31	41,9	1.65	47,8	1.88
A max	1,0	0.04	2,0	0.08	2,05	0.10	2,5	0.10	2,5	0.10	2,5	0.10	2,5	0.10	2,5	0.10
B min	8,0	0.31	12,0	0.47	12,0	0.47	14,0	0.63	16,0	0.63	18,0	0.71	20,0	0.79	22,0	0.87
B1 min (full thread)	13,0	0.51	18,5	0.73	18,5	0.73	22,0	0.94	24,0	0.94	27,0	1.06	29,0	1.14	31,0	1.22
D max	15,7	0.62	19,7	0.78	24,0	0.94	28,7	1.38	35,2	1.38	43,2	1.70	52,7	2.07	58,7	2.31
D6 min	16,2	0.64	20,2	0.81	24,9	0.98	29,4	1.43	36,4	1.43	44,4	1.75	53,4	2.10	59,9	2.36
D7 max	10,0	0.39	13,4	0.53	16,9	0.67	21,2	1.05	26,7	1.05	33,6	1.32	42,3	1.67	48,2	1.90

BSPT (Tapered) Threads Port Sealing

Sealing is achieved by means of metal to metal deformation of the adapter and port threads.

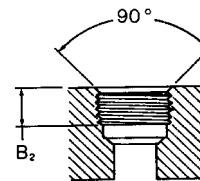

Thread Size	R 1/8"-28		R 1/4"-19		R 3/8"-19		R 1/2"-14		R 3/4"-14		R 1"-11		R 1 1/4"-11		R 1 1/2"-11	
	mm	in	mm	in	mm	in	mm	in	mm	in	mm	in	mm	in	mm	in
B2 min (full thread)	5,5	0.22	8,5	0.33	8,5	0.33	10,5	0.41	13,0	0.51	14,5	0.57	17,0	0.67	17,0	0.67

Recommended Parallel Connection Assembly Torque

Eaton recommends that a torque wrench be used to assure proper fitting assembly of these connections.

The values listed are for steel connections. Contact Eaton for torque values for other materials.

Straight Thread O-Ring Boss Low Pressure with 37° (SAEJ514)

Dash Size	Thread Size (inches)	Jam Nut or Straight Fitting Torque lb.-ft.	Jam Nut or Straight Fitting Torque Newton Meters
-03	3/8-24	8-9	12-13
-04	7/16-20	13-15	18-20
-05	1/2-20	14-15	19-21
-06	9/16-18	23-24	32-33
-08	3/4-16	40-43	55-57
-10	7/8-14	43-48	59-64
-12	1 1/16-12	68-75	93-101
-14	1 3/16-12	83-90	113-122
-16	1 5/16-12	112-123	152-166
-20	1 5/8-12	146-161	198-218
-24	1 7/8-12	154-170	209-230
-32	2 1/2-12	218-240	296-325

Straight Thread O-Ring Boss High Pressure with ORS (J1453)

Dash Size	Thread Size (inches)	Jam Nut or Straight Fitting Torque lb.-ft.	Jam Nut or Straight Fitting Torque Newton Meters
-03	3/8-24	8-10	11-13
-04	7/16-20	14-16	20-22
-05	1/2-20	18-20	24-27
-06	9/16-18	24-26	33-35
-08	3/4-16	50-60	68-78
-10	7/8-14	72-80	98-110
-12	1 1/16-12	125-135	170-183
-14	1 3/16-12	160-180	215-245
-16	1 5/16-12	200-220	270-300
-20	1 5/8-12	210-280	285-380
-24	1 7/8-12	270-360	370-490

ORS

Dash Size	Thread Size (inches)	Swivel Nut Torque lb.-ft.	Swivel Nut Torque Newton Meters
-04	9/16-18	10-12	14-16
-06	1 1/16-16	18-20	24-27
-08	1 3/16-16	32-35	43-47
-10	1-14	46-50	62-68
-12	1 3/16-12	65-70	88-95
-16	1 7/16-12	92-100	125-136
-20	1 11/16-12	125-140	170-190
-24	2-12	150-165	204-224

SAE 37° (JIC)

Dash Size	Thread Size (inches)	Swivel Nut Torque lb.-ft.	Swivel Nut Torque Newton Meters
-04	7/16-20	11-12	15-16
-05	1/2-20	15-16	20-22
-06	9/16-18	18-20	24-28
-08	3/4-16	38-42	52-58
-10	7/8-14	57-62	77-85
-12	1 1/16-12	79-87	108-119
-16	1 5/16-12	108-113	148-154
-20	1 5/8-12	127-133	173-182
-24	1 7/8-12	158-167	216-227
-32	2 1/2-12	245-258	334-352

Metric

Thread Size	Straight Adapter or Locknut Torque	
	lb.-ft.	Newton Meters
M10 x 1	13-15	18-20
M12 x 1.5	15-19	20-25
M14 x 1.5	19-23	25-30
M16 x 1.5	33-40	45-55
M18 x 1.5	37-44	50-60
M20 x 1.5	52-66	70-90
M22 x 1.5	55-70	75-95
M26 x 1.5	81-96	110-130
M27 x 2	96-111	130-150
M33 x 2	162-184	220-250
M42 x 2	170-192	230-260
M48 x 2	258-347	350-470

BSPP

Nominal Thread Size	Straight Adapter or Locknut Torque	
	lb.-ft.	Newton Meters
G 1/8-28	13-15	18-20
G 1/4-19	19-23	25-30
G 3/8-19	33-40	45-55
G 1/2-14	55-70	75-95
G 3/4-14	103-118	140-160
G 1-11	162-184	220-250
G 1 1/4-11	170-192	230-260
G 1 1/2-11	258-347	350-470

***"G" denotes parallel threads, other than ISO 6149. (Port connection only)

SPECIALTY & TRUCK HOSE
LOW & MEDIUM PRESSURE HOSE
HIGH PRESSURE HOSE
HOSE FITTINGS
ADAPTERS & TUBE FITTINGS
ACCESSORIES & ASSEMBLY INSTRUCTIONS
HOSE ASSEMBLY EQUIPMENT
APPENDICES

Proper Tube Installation

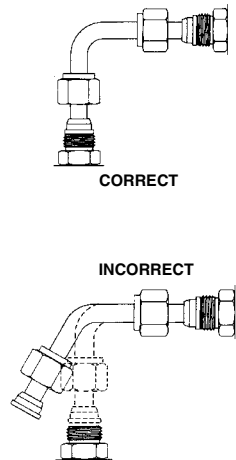

Figure 1

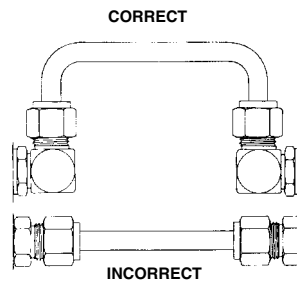

Figure 2

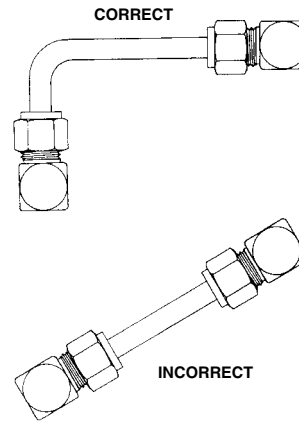

Figure 3

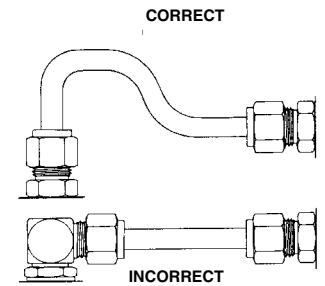

Figure 4

When compared to rigid pipe, hydraulic tubing offers the following advantages:

1. Size for size, tubing is lighter in weight, easier to handle and can be bent more easily than iron pipe.
2. Bent tubing reduces pressure drop and turbulence in the system because it eliminates sudden change in the direction of the fluid flow.
3. Hydraulic tubing reduces the number of connections required, thus reducing material and labor costs.
4. Fewer joints means lower costs and fewer points of potential leakage.
5. The use of tube fittings makes every joint a union which permits easier, faster maintenance and repair work.
6. The ORS-TF Tube Fitting eliminates the need for threading, brazing or welding.

Tube bending

To reduce the number of fittings in a tube assembly, bend the tubing whenever possible.

Steel tubing can be bent in many sizes by using a hand bender designed for steel tubing. For production quantities, or for larger sizes, a power bending tool is generally used. Contact Eaton for additional tube bending information.

Tube routing and installation

Tubing manufacturers will advise the correct radii for various types and wall thicknesses of tubing. Kinks, flattened bends, wrinkles and tube breakage can be avoided by the use of proper tube bending equipment.

Avoid straight line connections whenever possible, especially in short runs.

Fluid conveying systems (see figures 2, 3 and 4) should be designed to follow the contour of the equipment. They are easier to install and present a neater appearance. Long runs should be supported by brackets or clamps. All heavy systems components should be bolted or clamped to eliminate tubing fatigue.

Inspect the tubing to see that it conforms to the required specifications before installation.

Tubes should align with the center line of the fittings, without distortion or tension. Tubing should not be sprung into position (see figure 1) to be assembled to the fitting. If this occurs the tubing has not been properly fabricated, and when installed and connected, places the tubing under stress.

Conversions

Inch/Millimeter Conversion Table

Multiply inches x 25.4 = Millimeters

Inches			Millimeters			Inches			Millimeters			Inches			Millimeters		
fractions	decimals	decimals	fractions	decimals	decimals	fractions	decimals	decimals	fractions	decimals	decimals	fractions	decimals	decimals	fractions	decimals	decimals
1/64	.016	.397	17/64	.266	6.747	33/64	.516	13.097	49/64	.766	19.447						
1/32	.031	.794	9/32	.281	7.144	17/32	.531	13.494	25/32	.781	19.844						
3/64	.047	1.191	19/64	.297	7.541	35/64	.547	13.891	51/64	.797	20.241						
1/16	.063	1.588	5/16	.313	7.938	9/16	.563	14.288	13/16	.813	20.638						
5/64	.078	1.984	21/64	.328	8.334	37/64	.578	14.684	53/64	.828	21.034						
3/32	.094	2.381	11/32	.344	8.731	19/32	.594	15.081	27/32	.844	21.431						
7/64	.109	2.778	23/64	.359	9.128	39/64	.609	15.478	55/64	.859	21.828						
1/8	.125	3.175	3/8	.375	9.525	5/8	.625	15.875	7/8	.875	22.225						
9/64	.141	3.572	25/64	.391	9.922	41/64	.641	16.272	57/64	.891	22.622						
5/32	.156	3.969	13/32	.406	10.319	21/32	.656	16.669	29/32	.906	23.019						
11/64	.172	4.366	27/64	.422	10.716	43/64	.672	17.066	59/64	.922	23.416						
3/16	.188	4.763	7/16	.438	11.113	11/16	.688	17.463	15/16	.938	23.813						
13/64	.203	5.159	29/64	.453	11.509	45/64	.703	17.859	61/64	.953	24.209						
7/32	.219	5.556	15/32	.469	11.906	23/32	.719	18.256	31/32	.969	24.606						
15/64	.234	5.953	31/64	.484	12.303	47/64	.734	18.653	63/64	.984	25.003						
1/4	.250	6.350	1/2	.500	12.700	3/4	.750	19.050	1	1.000	25.400						

Pressure Conversion Table

(Per SAE J517 Appendix A)

Mpa	Bar	PSI	Mpa	Bar	PSI	Mpa	Bar	PSI	Mpa	Bar	PSI
0.25	2.5	35	4.2	42	600	20	200	2900	77	770	11000
0.3	3	45	4.3	43	625	21	210	3000	78	780	11250
0.35	3.5	50	4.9	49	700	22.4	224	3200	80	800	11600
0.4	4	56	5	50	725	22.7	227	3250	84	840	12000
0.4	4	62	5.2	52	750	24.5	245	3500	87	870	12500
0.5	5	70	5.6	56	800	28	280	4000	98	980	14000
0.6	6	90	6.1	61	875	29.7	297	4250	112	1120	16000
0.7	7	100	7	70	1000	31.5	315	4500	119	1190	17000
0.8	8	112	7.8	78	1125	33.5	335	4800	122	1220	17500
0.85	8.5	125	8.4	84	1200	35	350	5000	140	1400	20000
1	10	140	8.7	87	1250	38.5	385	5500	157	1570	22500
1.05	10.5	150	9.8	98	1400	40	400	5800	160	1600	23200
1.25	12.5	180	10	100	1450	42	420	6000	168	1680	24000
1.4	14	200	10.5	105	1500	43.5	435	6250	175	1750	25000
1.6	16	225	11.2	112	1600	45.5	455	6500	210	2100	30000
1.7	17	250	11.3	113	1625	49	490	7000	245	2450	35000
2.1	21	300	12.2	122	1750	52.5	525	7500	280	2800	40000
2.4	24	350	14	140	2000	56	560	8000	315	3150	45000
2.6	26	375	15.7	157	2250	59.5	595	8500	350	3500	50000
2.8	28	400	16.8	168	2400	61	610	8750			
3.5	35	500	17.5	175	2500	63	630	9000			
3.9	39	565	19.2	192	2750	70	700	10000			

A new method for calculating the equivalent metric conversion to Mpa from psi was utilized. This method provides an extremely easy and consistent method of conversion to arrive at a rounded metric units using

7 Mpa for each 1000 psi. The resulting Mpa pressure is never more than 1.7% higher than the mathematically correct Mpa unit when the pressure is higher than 250 psi. All operating pressures of SAE J517 hoses

are above 250 psi except for most of 100R4 and the 76mm (-48) and larger sizes of 100R5. Therefore all files of previous test results should not be compromised.

SPECIALTY & TRUCK HOSE
 LOW & MEDIUM PRESSURE HOSE
 HIGH PRESSURE HOSE
 HOSE FITTINGS
 ADAPTERS & TUBE FITTINGS
 ACCESSORIES & ASSEMBLY INSTRUCTIONS
 HOSE ASSEMBLY EQUIPMENT
 APPENDICES